

PUBLIC ROADS

A JOURNAL OF HIGHWAY RESEARCH



UNITED STATES DEPARTMENT OF AGRICULTURE
BUREAU OF PUBLIC ROADS



VOL. 17, NO. 2



APRIL 1936



ON U S 202 IN NEW HAMPSHIRE

PUBLIC ROADS

▶▶▶ *A Journal of
Highway Research*

Issued by the
UNITED STATES DEPARTMENT OF AGRICULTURE
BUREAU OF PUBLIC ROADS

Volume 17, No. 2

April 1936

The reports of research published in this magazine are necessarily qualified by the conditions of the tests from which the data are obtained. Whenever it is deemed possible to do so, generalizations are drawn from the results of the tests; and, unless this is done, the conclusions formulated must be considered as specifically pertinent only to described conditions.

In This Issue

	Page
The New Hampshire Financial Survey	21
Dimensions of Testing Equipment Affect Hubbard-Field Stability Values	38

THE BUREAU OF PUBLIC ROADS - - - - - Willard Building, Washington, D. C.
REGIONAL HEADQUARTERS - - - - - Mark Sheldon Building, San Francisco, Calif.

▼

DISTRICT OFFICES

- | | |
|--|---|
| DISTRICT No. 1. Oregon, Washington, and Montana.
Post Office Building, Portland, Oreg. | DISTRICT No. 8. Alabama, Georgia, Florida, Mississippi, and Tennessee.
Post Office Building, Montgomery, Ala. |
| DISTRICT No. 2. California, Arizona, and Nevada.
Mark Sheldon Building, 461 Market St., San Francisco, Calif. | DISTRICT No. 9. Connecticut, Maine, Massachusetts, New Hampshire, New Jersey, New York, Rhode Island, and Vermont.
505 Post Office Building, Albany, N. Y. |
| DISTRICT No. 3. Colorado, New Mexico, and Wyoming.
237 Custom House, Nineteenth and Stout Sts., Denver, Colo. | DISTRICT No. 10. Delaware, Maryland, Ohio, Pennsylvania, and District of Columbia.
Willard Building, Washington, D. C. |
| DISTRICT No. 4. Minnesota, North Dakota, South Dakota, and Wisconsin.
907 Post Office Building, St. Paul, Minn. | DISTRICT No. 11. Alaska.
Room 419, Federal and Territorial Building, Juneau, Alaska. |
| DISTRICT No. 5. Iowa, Kansas, Missouri, and Nebraska.
Saunders-Kennedy Building, Omaha, Nebr. | DISTRICT No. 12. Idaho and Utah.
Federal Building, Ogden, Utah. |
| DISTRICT No. 6. Arkansas, Louisiana, Oklahoma, and Texas.
Room 502, United States Courthouse, Fort Worth, Tex. | DISTRICT No. 14. North Carolina, South Carolina, Virginia, and West Virginia.
Montgomery Building, Spartanburg, S. C. |
| DISTRICT No. 7. Illinois, Indiana, Kentucky, and Michigan.
South Chicago Post Office Building, Chicago, Ill. | |

Because of the necessarily limited edition of this publication it is impossible to distribute it free to any person or institutions other than State and county officials actually engaged in planning or constructing public highways, instructors in highway engineering, and periodicals upon an exchange basis. At the present time additions to the free mailing list can be made only as vacancies occur. Those desiring to obtain PUBLIC ROADS can do so by sending \$1 per year (foreign subscription \$1.50), or 10 cents per single copy, to the Superintendent of Documents, United States Government Printing Office, Washington, D. C.

THE NEW HAMPSHIRE FINANCIAL SURVEY

DIGEST OF A SURVEY OF THE FINANCES OF NEW HAMPSHIRE IN 1932, WITH SPECIAL REFERENCE TO HIGHWAYS, CONDUCTED BY THE BUREAU OF PUBLIC ROADS AND THE UNIVERSITY OF WISCONSIN

Reported by ELIZABETH CHURCH, Assistant Research Analyst, Division of Highway Transport, Bureau of Public Roads

THE NEW HAMPSHIRE financial survey is one of a series of studies in highway finance sponsored by the United States Bureau of Public Roads in cooperation with the University of Wisconsin and the highway department in each of the States studied.¹

The survey covers for the year 1932 the financial transactions of the State of New Hampshire and its political subdivisions, with special emphasis upon highways. Space does not permit giving much explanatory data and descriptions, so where factual material in tables can be readily understood without additional interpretation, comments have been omitted. An effort has been made to include all of the salient material and to discuss adequately the important problems and conditions pertaining to New Hampshire highways. For greater ease of comparison the arrangement of material follows that of previous summaries.²

The two primary objectives of the survey were: (1) To ascertain the fiscal relation of highways to all other fiscal affairs of the community; and (2) to show facts pertaining particularly to highways, such as highway classifications, mileage and surfacing, expenditures for maintenance, construction, and overhead, and the sources of funds necessary to defray the costs, both by types of imposts and by the locality providing them.

CLASSIFICATION OF PRIMARY ROUTES

Probably the most important facts concerning New Hampshire highways are those pertaining to the administration of the primary roads and the results obtained under the State-aid plan. In addition, attention is called to the increase in efficiency and economy that might result through consolidation of local road operations, the advantages accruing through a closer connection between the State highway department and localities, both in the furnishing of engineering services and the approval of certain construction projects, and the need for the codification of the highway statutes.

The present system of administering the primary highway system is confusing. The legally designated trunk lines comprise a major part of the primary system, but they do not include all of the numbered routes. The primary system, therefore, is administered under several different statutory provisions.

The traveled primary system of New Hampshire at the present time comprises some 1,809 miles of numbered through routes. Of this total, 1,517 miles are trunk-line mileage as officially designated by the legislature, 90 miles are State roads on the numbered system, and the remaining 202 miles are State-aid highways. This difference is one of technical terminology only, however.

Of the 1,517 miles of official trunk-line highways, 1,456 miles comprise the official trunk-line system financed by the State and administered by the State

highway department under special laws applying only to the trunk lines. The remaining 61 miles are within city limits, are under municipal control, and are financed by the municipality through which they pass. The 90 miles of State roads upon the numbered system are also financed by the State and administered by the highway department, but under statutory provisions other than those covering the officially designated trunk lines. The State, therefore, has complete jurisdiction over only 1,546 miles of the numbered highway routes.

The variety of classifications on the numbered primary routes resulted from the piecemeal enactment of trunk-line highway legislation only as necessity demanded. The State-aid plan was designed to create through routes but failed to accomplish this purpose. Certain towns failed or refused to cooperate, leaving gaps in the planned through system and thus defeating the intent of the plan. As a remedy, special laws were then passed designating specific roads as trunk-line routes and prescribing special methods for financing and administration, still based to some extent, however, upon the standard State-aid plan. Bit by bit additional mileages were added and new laws enacted until the present status was evolved.

The primary system, therefore, is administered under several different statutory provisions. If the legally designated trunk-line system and the numbered system of through routes were made coextensive and placed completely under State control, financial responsibility would be centralized, administration simplified, and confusion eliminated.

Although the established practice of designating highways by a number and keying the number to a map is used in New Hampshire, it has no legislative sanction. Each of the trunk routes is described in the laws by a name, such as the "Daniel Webster Highway." Some qualified body could be authorized to designate officially the principal routes by numbers. If a secondary system were established, symbols could be used to distinguish the systems.

At present State laws do not permit the expenditure of State funds for highways in compact areas of 2,500 persons or over, yet the urban portions of the trunk highways must be adequate to serve the through traffic upon them.

The State-aid roads are primarily local rural roads which the State helps support through the allocation to local communities of part of the State motor-vehicle revenues. The funds are allocated in proportion to local taxation. Organized planning is extremely difficult because of the large number of local governmental units. Although the revenues for the State's participation are derived from highway users, no system of roads serving State-wide traffic and coordinated with the primary routes has been developed. A secondary highway system could readily be developed, however, using a considerable mileage of the present State-aid roads as a basis.

¹ The investigation was made in 1934 under the immediate direction of Dr. Henry R. Trumbower, professor of economics at the University of Wisconsin and economist for the Bureau of Public Roads, and H. R. Briggs, field investigator and statistician.

² For results of the Wisconsin, Michigan, Illinois, and Minnesota surveys, see the April 1933, June 1933, May 1933, and March 1936 issues of PUBLIC ROADS.

The present system of having the local town road maintenance under the supervision of over 500 different road agencies is expensive and relatively inefficient. There is extreme variation between towns in the average maintenance costs per mile on the local rural roads. This is due, among other causes, to low standards of maintenance, lack of funds and equipment, and lack of supervision and efficient advisory services.

The creation of a permanent patrol system with full-time road workers and a system of road districts would promote efficiency and economy. The creation of road districts comprising territorial areas larger than individual towns or having the work done by the divisions of the State highway department under contractual arrangements would accomplish these ends.

Expensive reconstruction costs could be avoided if it were required that construction projects upon local roads involving an expenditure of \$2,000 or more and every bridge constructed be approved by the State highway department before work is undertaken.

For the making of plans and all other services connected with the development of local roads, the staff of the highway department could continue to be available to give such assistance as might be required. Whether or not the highway department should be compensated for services other than those of a purely advisory nature is a matter of State policy. Probably the present system of charging a moderate fee for the work done is the most equitable plan.

In the existing statutes there are duplications, conflicts, and apparently obsolete or unenforced provisions. These conditions could be corrected by a codification of the highway laws and the repeal of undesired and unenforced statutes. Additional legislation is needed to revise and simplify the highway classifications.

GENERAL CHARACTERISTICS OF STATE

Many local factors have influenced the development of the highway system in New Hampshire. Large areas of the State are of little economic value; consequently, the revenues of the State and, therefore, the amounts available for highways are limited. The mountains affect highway locations and costs. The industrial centers that have grown up around water-power development projects have further influenced the highway routing. Since there is heavy tourist traffic in the State, the providing of adequate highway facilities for this travel has been important.

Because at present all parts of the State are within a reasonable distance of some suitable road-building material, local costs are quite comparable. In some localities, however, these deposits of materials will soon be exhausted. In such places the additional cost of transporting materials longer distances will then have to be met.

There are 10 counties in New Hampshire, subdivided into 224 organized towns and 11 incorporated cities. The towns are similar in size and political organization to the townships in the States outside of New England. The towns are further subdivided into precincts and school districts, not necessarily coextensive. Manchester, with a population of 76,834, is the largest city. The total population of the State in 1930 was 465,293, of which 345,034 were in urban communities and 120,259, or almost 26 percent, in rural areas—the non-compact areas of towns or cities.

The assessed valuation of all taxable property in New Hampshire in 1932 was \$623,381,900. Twenty-nine

percent of this total, or \$183,277,600, was in rural areas. In Manchester alone there was \$106,151,900 worth of taxable property, or 17 percent of the total property valuation in the State. Almost 56 percent of the total valuation was concentrated in the southeastern part of the State. This portion of New Hampshire is its largest manufacturing area and contains 9 of the State's 11 incorporated cities. The entire northern half of the State had but one-fourth of the total assessed valuation of the State.

PLAN OF STUDY OUTLINED

For purposes of analysis and presentation, financial data must be set up on comparable bases. It is necessary to show the proper division of the financial data for the various civil subdivisions, to give the proper analysis of data relative to incorporated cities, and to present all the data for all subdivisions of the State by some convenient division.

Since the 10 counties of the State are unimportant as governmental agencies, county units were disregarded except insofar as financial statistics were properly allocated between the governmental units comprising each.

In the financial surveys conducted by the Bureau the statutory designations of governmental units smaller than the counties have been ignored because of the varying concepts applying to the same term. Data are shown instead for rural areas and urban communities, the latter according to population. In New Hampshire grouped the statutory classification of an area as a town or a city does not signify that the area is rural or urban in its characteristics. The statutory town in New Hampshire may include urban communities, while the statutory city may have extensive rural areas within its limits. Since a classification was essential for this survey, it was necessary to determine by field investigation the urban and rural populations of the various towns in the State and the size of those communities. In all the towns a subdivision was made between the compact areas definitely urban in character and the rural sections. The division into classes of residence is as follows:

1. Rural areas outside of any settlements or communities.
2. Urban places having a population to 2,499.
3. Urban places having a population of 2,500 to 14,999.
4. Urban places having a population of 15,000 to 74,999.
5. Urban places having a population of 75,000 to 399,999.

Manchester is the only place in New Hampshire having a population over 75,000.

Since all taxes are levied by the public acts of governmental agencies, it is necessary to know which agency initiates the tax. The first classification of imposts is by type of revenue, listed by the public agency responsible for its imposition. Such a tabulation shows the total public imposts levied by each governmental unit according to type of impost. The second classification is by incidence of impost and shows the communities responsible for paying the tax. The local communities carry on their own government, raise their own revenues, and make their own disbursements. In addition, however, the counties and State perform functions for the benefit of these local areas. For these activities the State and counties levy imposts

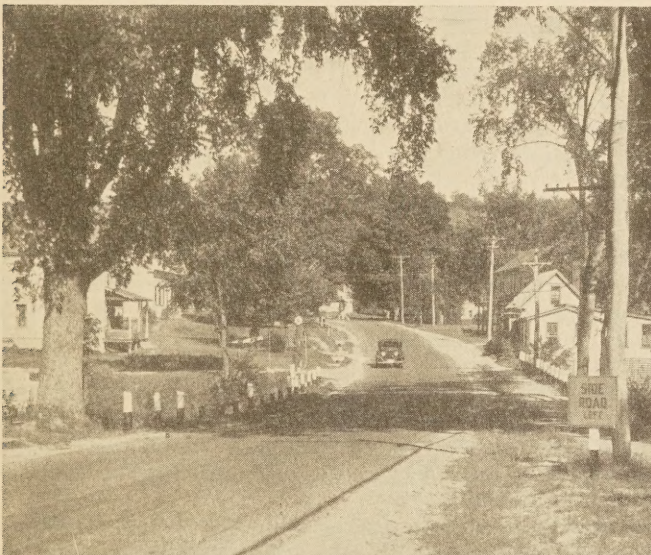
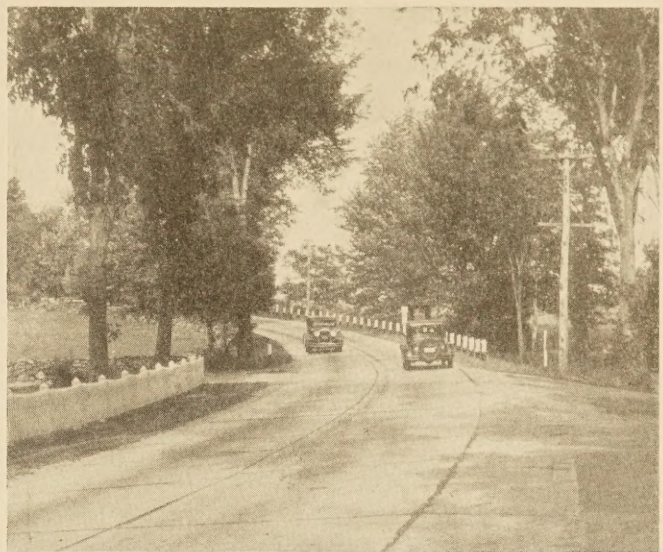

HIGHWAYS IN NEW HAMPSHIRE:

against the property and inhabitants of local areas. Thus, communities have their own local taxes and also imposes that they must pay to larger governmental units. Therefore, to classify taxes according to incidence, both local and other charges must be allocated and the total for which each community is responsible must be shown. So far as possible, all imposts are further subdivided as to the purpose for which they are levied. They are divided into levies for four purposes—highways and streets, education, public benefit, and government.

The main considerations in classifying expenditures are the units of government originally making them and the determination of the place where they are finally made. Besides the local expenditures, it is necessary to take into consideration the expenditures made by the larger units of government in the various minor governmental units for the benefit of the persons and property in those local communities. The final comparison, then, is based on the local expenditures plus the expenditures made by the State and the county in or for each community.

The outstanding indebtedness is first classified by the unit of government incurring it. The debts are also subdivided by the purposes for which they were incurred. Debt service is classified by purpose only. Partial allocation of the debt service by units of government and by rural or urban areas is made in the expenditure classification where interest payments are included.

SOURCES OF MATERIAL

For proper interpretation of the data obtained in this survey, a brief description of the methods employed is necessary. Analogous procedures were followed in the financial surveys made by the Bureau in other States.

Because governmental financial records are kept from the accounting standpoint to reflect financial transactions with specific funds they are not readily adaptable to statistical purposes. The numerous transfers, different concepts of public functions, and different methods of handling funds in various communities almost always require a careful analysis and reassembly of all public financial data if factual results are to be obtained.

In no case were totals for tax levies, expenditures, debts, road mileages, or any other facts, taken from previous compilations or reports. The original data were collected and analyzed, and from them the needed facts were extracted without omission or duplication. A complete financial analysis involves finding the data for public utilities, special assessment districts, special districts, and municipalities, and combining these to obtain the total of all local receipts, debts, and expenditures. To these are added the proper allocation of similar data for the State and counties, thus obtaining a complete analysis of the receipts, expenditures, and debts of the rural and urban areas of the State.

Two special problems were encountered in the tax analysis. The first of these was due to the fact that while each agency has its own specific taxes, there are a number of taxes that are levied or collected jointly. These have been treated as joint State and local imposts.

The second problem is more important. In New Hampshire, a tax levy is different from the tax actually imposed. This is true because of the method of using the property tax as a balancing item to provide needed funds. The total of all public receipts other than property taxes are subtracted from the total budgetary requirements. The additional sum required is submitted to the collector to be extended against the property in the community. For example, the State property tax was \$1,400,000 and each town and city was charged with its portion of this tax based upon its valuation as fixed by the tax commission. However, the State as agent collects certain taxes for all the towns. Instead of remitting these receipts, the State offsets the amounts received for each town against the property tax for the town and only the difference is charged to the town for collection. Hence the property tax levied against a town is no measure of the impost of that nature that it will actually pay.

The same procedure is followed in the towns. The town levies the State property tax eventually charged against it, the county property tax, and other property taxes at specified rates for roads, schools, and other purposes. These are totaled and constitute the theoretical property tax levy. From this total all the other town receipts are subtracted and the remainder is spread against the taxable property as the actual property tax.

In New Hampshire there are three major imposts on all motor vehicles: The State registration fee, the gasoline tax, and the local permit fee charged in lieu of local personal property taxes. The problem presented itself of subdividing the data pertaining to each of these motor-vehicle imposts between the rural areas and the four classes of urban communities. No data were available for making such divisions for any of these three imposts. The same procedure, therefore, was followed that has been used successfully in other States for making such allocations. On the basis of the tabulation and analysis of a large representative sample of license fees paid, the allocation of the total amount received from registration fees was made. Questionnaires were sent to motor-vehicle owners to ascertain the gasoline tax paid by the residents in the several classes of places. In all studies it has been possible to determine the accuracy of the sample by several statistical checks. The information pertaining to highway classifications, mileages, and surfaces was obtained from the State highway department.

The material presented in this and previous Bureau studies of New Hampshire was obtained from the same sources. However, this study was conducted on an entirely different basis from any previous Bureau survey of the State, so differences in final results were anticipated. It has been possible to make reconciliations to these other reports.

DEFINITION OF TERMS

For uniformity the following definitions are basic in all the surveys:

Highway includes all items having to do with the construction, maintenance, marking, erection of signs, and administration of all highways, streets, and alleys. Street cleaning and street lighting are not included.

Education consists of all items having to do with the construction, maintenance, teaching, and administration of all public schools and libraries.

Public benefit consists of all items having to do with the protection of lives and property, and the pleasure or well-being of the people, including police and fire protection, courts, sanitation, parks and playgrounds, and charitable and penal institutions.

Government consists of all items having to do with the general administration of public affairs not allocable to one of the three preceding public purposes. These are primarily the executive and administrative functions of government.

Expenditure means public costs defrayed out of public revenues. The net cost is shown, not the gross amount. The net expenditure is the total expenditure less the earnings made by the public service charged with the costs. For example, the cost of prisons is the total expenditure less the earnings from prison industries.

Imposts include every payment of any nature made to a public body occurring because of or in connection with the authority vested within it. Thus, all licenses, fees, permits, special assessments, and taxes proper are shown as imposts.

User revenues are imposts in the form of vehicle licenses, gasoline taxes, and allied charges paid by the operators of motor vehicles.

There is great variety in the dates of the fiscal years used by governmental agencies in New Hampshire. The State government and school districts have their fiscal years ending June 30; the counties use December 31; towns and villages use January 31; and cities use various dates from November 30 to February 28. Data are shown in this report for the calendar year 1932. In cases where the calendar and fiscal years did not coincide, slight adjustments were made to obtain comparable statistics.

NEW HAMPSHIRE HIGHWAY SYSTEM

New Hampshire laws and reports show six statutory classifications of highways as follows:

Class 1 roads include the officially designated State trunk-line highways and other State roads, all completely under State control. These roads include 1,456 miles of designated State trunk-line highways, 90 miles of State numbered routes not on the trunk-line system, and 50 miles of other State highways in mountainous and thinly settled areas, making a total of 1,596 miles of class 1 roads.

Class 2 roads include the State-aid roads, that are roads under joint State and local jurisdiction. This

class comprises 1,235 miles of local roads and 202 miles of roads on the State numbered highway system, making a total of 1,437 miles.

Class 3 roads are the uncompleted sections of the State trunk-line highway system. As the trunk-line highway system has been completed, there are no roads of this statutory classification.

Class 4 roads are streets in compact areas, and are under local control. There are 61 miles of urban streets forming a part of the designated trunk-line highway system, and 500 miles of other urban streets, making a total of 561 miles of class 4 roads.

Class 5 roads are the local town roads under local control. There are 8,717 miles of these local town roads.

Class 6 roads are abandoned roads. For the purposes of this report this class of roads has no significance.

The State numbered primary highway system of 1,809 miles consists of: Designated State trunk roads completely under State control, 1,456 miles; roads completely under State control but not on the trunk-line highway system, 90 miles; streets that are in compact areas and completely under local control, 61 miles; and State-aid roads that are under joint State and local control, 202 miles.

Thus there is an overlapping of the roads as grouped by statutory designation and by administrative control.

In 1932 there were 12,311 miles of roads and streets in New Hampshire. Of this total 11,750 miles, or 95.4 percent, were highways outside of compact areas. Table 1 and figure 1 show that over 70 percent of the rural roads of the State in 1932 were unsurfaced. Over 8,200 miles, or 94 percent, of the local town roads were earth. All of the State and State-aid roads were surfaced. The State and State-aid roads were mainly of a low-type

surfacing, however, and less than 4 percent of the rural highways of the State had a concrete or other high-type surfacing. No data were collected as to the types of surfacing on the streets in compact areas (class 4 roads).

Almost three-fourths of the rural highways in New Hampshire are local town roads. The State highway department has control over the administration and financing of 25.8 percent of the rural highways. There are no county roads, nor does the county spend anything for highways.

TAXES LEVIED AND INCIDENCE OF TAXATION

Table 2 gives the total taxes levied for all purposes in New Hampshire in 1932 by the several classes of governmental units. The relative unimportance of the functions of the county in New Hampshire is apparent. It is evident that the bulk of the taxes were levied by the local communities for their own use.

All State and county imposts are ultimately paid by the taxpayers in rural and urban areas. In table 3 the State and county levies have been distributed and the amounts added to the local charges to obtain the total amounts payable by the residents in the various classes of rural and urban communities.

The revenues for all purposes were obtained from the various sources shown in table 4.

All imposts have been subdivided by governmental unit levying them, by residence of taxpayers paying them, and by type of impost. The general

property tax accounted for over 60 percent of the total revenue. The motor-vehicle imposts were of next importance, \$5,270,000 being obtained from these taxes. Over \$490,400 of the motor-vehicle imposts was collected from nonresidents.

NEW HAMPSHIRE TAXES IN 1932

Total taxes and imposts levied for all purposes in New Hampshire in 1932 were \$27,089,600. Taxation of general property totaled \$16,342,900, or 60.3 percent; imposts paid by motor-vehicle owners, \$5,270,000, or 19.5 percent; other revenues, consisting of insurance, inheritance, utility and savings-bank taxes, and miscellaneous State and local imposts, \$5,476,700, or 20.2 percent.

Of the total taxes and imposts levied, rural taxpayers paid \$6,769,900, or 25 percent; those in incorporated places having a population to 2,499, \$4,559,400, or 16.8 percent; in places of 2,500 to 14,999 population, \$6,459,400, or 23.8 percent; in places of 15,000 to 74,999 population, \$4,509,400, or 16.7 percent; in Manchester, \$4,301,100, or 15.9 percent; and nonresidents paid \$490,400, or 1.8 percent.

The average actual tax rates on general property, per \$100 valuation, were as follows: Rural areas, \$2.34; incorporated places to 2,499 population, \$2.76; places 2,500 to 14,999 population, \$2.75; places 15,000 to 74,999 population, \$2.92; and Manchester, \$2.54.

Rural motor-vehicle owners paid in license fees, gasoline taxes, and miscellaneous motor-vehicle imposts an average of \$42.04; residents in places to 2,499 population, \$44.34; in places 2,500 to 14,999 population, \$44.98; in places 15,000 to 74,999 population, \$49.81; and in Manchester, \$53.38.

TABLE 1.—Classification of rural highways in 1932 by official designation and by type of surfacing

Official designation	Concrete		Bituminous macadam		Stone, gravel, etc.		Earth		Total	
	Miles	Pct.	Miles	Pct.	Miles	Pct.	Miles	Pct.	Miles	Pct.
Class 1 roads (State highways).....	222	13.9	188	11.8	1,186	74.3	-----	-----	1,596	13.6
Class 2 roads (State-aid roads).....	4	.3	14	1.0	1,419	98.7	-----	-----	1,437	12.2
Class 5 roads (local town roads).....	1	-----	24	.3	448	5.1	8,244	94.6	8,717	74.2
Total.....	227	1.9	226	1.9	3,053	26.0	8,244	70.2	11,750	100.0

TABLE 2.—Distribution of all taxes levied for all purposes by the State and its subdivisions for collection in 1932

Imposed by—	Amount	Per cent	Amount per capita
State.....	\$8,425,900	31.1	\$18.11
Counties.....	1,406,300	5.2	3.02
Rural areas.....	4,325,200	16.0	35.97
Places to 2,499.....	2,795,000	10.3	34.75
Places 2,500 to 14,999.....	4,148,200	15.3	37.35
Places 15,000 to 74,999.....	3,094,900	11.4	40.35
Manchester.....	2,894,100	10.7	37.67
Total.....	\$27,089,600	100.0	58.22

¹ Includes \$490,400 of motor-vehicle charges imposed on nonresidents.

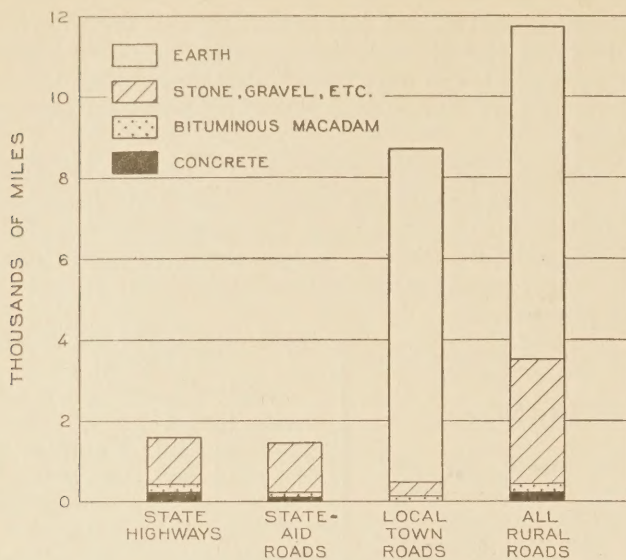

FIGURE 1.—MILEAGE OF NEW HAMPSHIRE RURAL HIGHWAYS IN 1932, BY TYPES.

TABLE 3.—Incidence of all State and local charges imposed in 1932

Payable by taxpayers in—	Amount	Percent	Amount per capita
Rural areas.....	\$6,769,900	25.4	\$56.30
Places to 2,499.....	4,559,400	17.1	56.69
Places 2,500 to 14,999.....	6,459,400	24.3	58.16
Places 15,000 to 74,999.....	4,509,400	17.0	58.79
Manchester.....	4,301,100	16.2	55.98
Total.....	26,599,200	100.0	57.17
Nonresidents.....	490,400		
Grand total.....	27,089,600		

Table 5 is a recapitulation of table 4 and shows the liability of the residents of the various rural and urban areas for the payment of the several kinds of taxes, but it does not include the motor-vehicle imposts paid by nonresidents.

Table 6 gives, in the second column, the tax rates per \$100 valuation levied upon general property in each of the several classes of local governmental units. For purposes of comparison, the third column gives the rates that would have been required if the total amount received from all taxation had been levied upon general property, and the last column gives the percentages that general property taxes were of all taxes paid by residents. Figure 2 is a graphical presentation of these data.

IMPOSTS USED FOR HIGHWAY PURPOSES

The only taxes levied specifically for highway purposes were the State motor-vehicle imposts—license fees, gasoline taxes, and miscellaneous motor-vehicle imposts—which totaled \$4,757,000. The localities collected a permit fee on motor vehicles, but the proceeds from this impost went into the general community fund and only about \$91,000 was used for highway purposes. These user revenues comprised \$4,848,000 of funds for street and highway purposes or 59 percent of the total for such purposes.

Since the total 1932 highway program required \$8,202,300, part of the revenue from the general property taxes and other imposts had to be used for highway purposes. Table 7 shows that to meet this need

TABLE 4.—Sources of revenue by type of tax or revenue

Type of tax	Amount	Per cent	Amount per capita
General property tax.....	\$16,342,900	60.3	\$35.12
Other imposts:			
State:			
Telephone and telegraph taxes.....	319,200	1.2	0.69
Gas and electric company taxes.....	175,300	.6	.38
Inheritance tax.....	459,000	1.7	.99
Motor-vehicle imposts.....	4,757,000	17.6	10.22
Licenses, fees, permits.....	271,300	1.0	.58
Miscellaneous income.....	214,700	.8	.46
Total State.....	6,196,500	22.9	13.32
Joint State and local:			
Insurance taxes.....	442,500	1.6	.95
Savings-bank tax.....	636,800	2.3	1.37
Intangibles tax.....	586,100	2.2	1.26
Railroad tax.....	937,900	3.5	2.02
Building and loan association tax.....	1,600		
Total joint State and local.....	2,604,900	9.6	5.60
Local:			
Motor-vehicle permit fee.....	513,000	1.9	1.10
Poll tax.....	332,200	1.2	.72
National bank-stock tax.....	51,800	.2	.11
Licenses, permits, fees.....	101,800	.4	.22
Miscellaneous income.....	927,000	3.4	1.99
Total local.....	1,925,800	7.1	4.14
County—Miscellaneous imposts.....	19,500	.1	.04
Total other imposts.....	10,746,700	39.7	23.10
Grand total.....	27,089,600	100.0	58.22

RECAPITULATION

General property taxes.....	16,342,900	60.3	35.12
Motor-vehicle imposts.....	4,757,000	17.6	11.33
Other State imposts.....	1,439,500	5.3	3.09
Joint State and local imposts.....	2,604,900	9.6	5.60
Other local imposts.....	1,412,800	5.2	3.04
Miscellaneous county imposts.....	19,500	.1	.04
Total.....	27,089,600	100.0	58.22

¹Includes \$490,400 of imposts charged against nonresidents.

TABLE 5.—Incidence and classification of all taxes levied in 1932 and paid by residents

Payable by taxpayers in—	General property taxes		Motor-vehicle imposts		Other taxes		All taxes	
	Amount	Per cent	Amount	Per cent	Amount	Per cent	Amount	Per cent
Rural areas.....	\$4,280,400	26.2	\$1,131,600	23.7	\$1,357,900	24.8	\$6,769,900	25.4
Places to 2,499.....	2,634,100	16.1	1,019,500	21.3	905,800	16.6	4,559,400	17.1
Places 2,500 to 14,999.....	3,815,600	23.3	1,229,600	25.7	1,414,200	25.8	6,459,400	24.3
Places 15,000 to 74,999.....	2,918,300	17.9	696,500	14.6	894,600	16.3	4,509,400	17.0
Manchester.....	2,694,500	16.5	702,400	14.7	904,200	16.5	4,301,100	16.2
Total.....	16,342,900	100.0	4,779,600	100.0	5,476,700	100.0	26,599,200	100.0
Percentage of all taxes.....		61.4		18.0		20.6		100.0

¹Made up as follows: \$2,340,600 of gasoline taxes, \$1,569,500 of registration fees, \$356,500 of miscellaneous imposts and \$513,000 of local permit fees.

\$2,865,800 was derived from the general property tax, and \$488,500 from other revenue sources. The special assessment method of financing highways, although it is extensively used elsewhere, is not used in New Hampshire.

Nonresidents paid at least \$436,000 of user revenues expended upon New Hampshire highways. The license fees and miscellaneous imposts paid by them were known. The total amount of gasoline consumed by vehicles owned by New Hampshire residents was obtained and thus the total amount of gasoline tax paid

by them was determined. The balance, found by deducting the amount paid by New Hampshire residents from the total gasoline tax collected, was the amount paid by nonresidents.

TABLE 6.—General property tax rates per \$100 valuation in 1932, and their relation to the total of all imposts

Unit of government in which taxes were payable	Actual tax rate on general property as levied ¹	Tax rate needed to raise all taxes by general property tax levies ²	Percentage that general property taxes are of all taxes and imposts ³
Rural areas.....	\$2.34	\$3.69	63.2
Places to 2,499.....	2.76	4.78	57.8
Places 2,500 to 14,999.....	2.75	4.65	59.1
Places 15,000 to 74,999.....	2.92	4.52	64.7
Manchester.....	2.54	4.05	62.6
Average for State.....	2.62	4.27	61.4

¹ Statutory standard of assessment is full value, and assessment is made substantially at that figure.
² Based on total, excluding \$490,400 paid by nonresidents.

TABLE 7.—Taxes from which funds were derived for highway and street purposes in 1932

Type of tax	Amount	Per cent	Amount per capita
Local general property tax.....	\$2,865,800	34.9	\$6.16
Motor-vehicle imposts:			
Road toll.....	¹ 2,638,800	32.2	5.67
License fees.....	² 1,723,100	21.0	3.70
Miscellaneous imposts.....	³ 395,100	4.8	.85
Local permit fees.....	91,000	1.1	.20
Total user revenues.....	\$4,848,000	59.1	10.42
Total general property tax and user revenues.....	7,713,800	94.0	16.58
Other imposts ⁴	488,500	6.0	1.05
Grand total.....	\$8,202,300	100.0	17.63

¹ Includes \$298,200 paid by nonresidents.
² Includes \$153,600 paid by nonresidents.
³ Includes \$38,600 paid by nonresidents.
⁴ Includes \$490,400 paid by nonresidents.
⁵ Made up of national bank-stock tax, miscellaneous license fees and permits, poll tax, miscellaneous income and commercial revenues, insurance tax, savings-bank tax, intangibles tax, building and loan association tax, and railroad tax.
⁶ This amount was needed to meet expenses of administering motor-vehicle taxes and principal payments on highway debt in addition to the amounts actually expended upon highways and streets.

The amount of imposts levied for highway and street purposes paid by the residents of the State was \$7,711,900, as shown in table 8. The amount given for each class of place is the sum of all taxes imposed for highway purposes. For the urban places this included the contributions for local street improvements as well as the urban share of the rural highway program.

MOTOR-VEHICLE REGISTRATIONS, IMPOSTS, AND TRAVEL PERFORMED

Of the 104,383 motor vehicles registered in New Hampshire in 1932, 87,217, or 83.6 percent, were passenger cars.³ This was 1 passenger car for every 5.3 persons. The ratio for trucks and busses was 1 to every 27.1 persons.

To obtain their approximate distribution between the rural areas and the several classes of urban places, a sample of the registrations was tabulated by locality. Questionnaires were then sent to those motor-vehicle owners whose locations were uncertain. Several checks made against known facts determined the accuracy of the results. Table 9 shows the distribution of motor vehicles among the several classes of places.

³ These figures exclude nonresident registrations and are therefore somewhat smaller than figures previously issued by the Bureau.

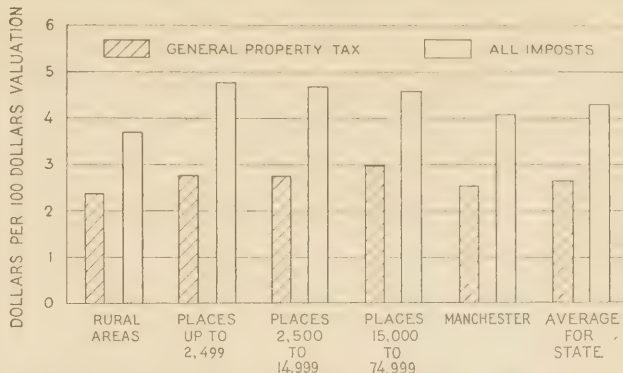

FIGURE 2.—ACTUAL TAX RATES ON GENERAL PROPERTY AND RATES REQUIRED IF ALL TAXES WERE LEVIED ON GENERAL PROPERTY.

TABLE 8.—Incidence of taxes used for street and highway purposes in 1932, classified by places

Payable by taxpayers in—	Amount	Per cent	Amount per capita
Rural areas.....	\$2,150,000	27.9	\$17.88
Places to 2,499.....	1,459,800	18.9	18.15
Places 2,500 to 14,999.....	1,826,500	23.7	16.44
Places 15,000 to 74,999.....	1,162,200	15.1	15.15
Manchester.....	1,113,400	14.4	14.49
Total.....	7,711,900	100.0	16.57
Nonresidents.....	490,400		
Grand total.....	8,202,300		

Registration fees collected from motor-vehicle owners in New Hampshire are based upon the weight of the vehicle. New Hampshire residents in 1932 paid \$1,569,500 in motor-vehicle license fees, an average of \$15.04 per vehicle. Owners of trucks and busses paid an average fee of \$25.04 and passenger-car owners paid \$13.07. Nonresident registration fees totaled \$153,600, about 9 percent of the total of \$1,723,100 received from license fees. The total and average amounts paid by the owners in the various places are shown in table 9. The highest average passenger-car and truck fees were paid by motor-vehicle owners in the largest cities, and the lowest were paid by motor-vehicle owners in the rural areas. These deviations are normal, for the most valuable and heaviest passenger cars and trucks are usually found in urban areas.

The cost of collecting the motor-vehicle license fees was approximately \$77,000, or 4.9 percent of the total gross revenue, making a cost of 74 cents per vehicle. This was the cost of licensing and all allied activities.

DISTRIBUTION OF TRAVEL PERFORMED AND GASOLINE CONSUMPTION DETERMINED BY QUESTIONNAIRES

As in the other States studied, questionnaires were sent to a representative sample of the motor-vehicle owners of the State to determine the amount of gasoline consumed and the number of miles traveled during the year. The results obtained by these questionnaires are shown in table 10. Of all vehicles in the various classes of places, those in the rural areas traveled the least, averaging 6,836 miles annually, while the vehicles in Manchester traveled the most, averaging 8,679 miles. Trucks and busses traveled, on an average, about 10 percent more than passenger cars.

Table 10 also shows that the average annual gasoline consumption per vehicle by trucks and busses was

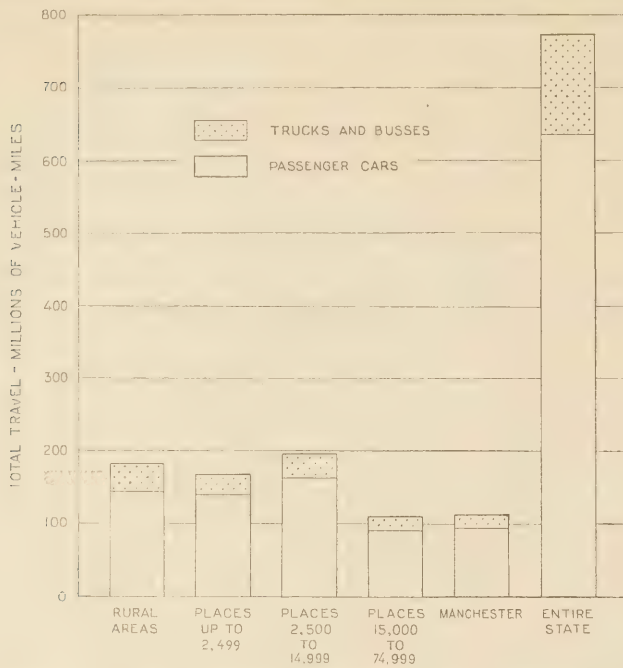

FIGURE 3.—TOTAL TRAVEL PERFORMED BY PASSENGER CARS AND TRUCKS AND BUSES IN 1932, DISTRIBUTED BY PLACE OF OWNERSHIP.

TABLE 9.—Motor-vehicle registrations, persons per vehicle, and registration fees paid, distributed by place of ownership among the several classes of local governmental units

Place of ownership	Registrations		Persons per vehicle	Registration fees		
	Number	Per cent		Amount	Per cent	Amount per vehicle
Rural areas:						
Passenger cars.....	21,811	¹ 25.0	5.5	\$274,200	¹ 24.1	\$12.57
Trucks and busses.....	5,100	² 29.7	23.6	108,300	² 25.2	21.24
Total.....	26,911	25.8	4.5	382,500	24.4	14.21
Places to 2,499:						
Passenger cars.....	19,140	¹ 21.9	4.2	251,200	¹ 22.0	13.12
Trucks and busses.....	3,852	² 22.4	20.9	90,500	² 21.1	23.49
Total.....	22,992	22.0	3.5	341,700	21.8	14.86
Places 2,500 to 14,999:						
Passenger cars.....	23,159	¹ 26.6	4.8	305,700	¹ 26.8	13.20
Trucks and busses.....	4,179	² 24.4	26.6	116,100	² 27.0	27.78
Total.....	27,338	26.2	4.1	421,800	26.9	15.43
Places 15,000 to 74,999:						
Passenger cars.....	11,849	¹ 13.6	6.5	160,300	¹ 14.1	13.53
Trucks and busses.....	2,134	² 12.4	35.9	60,000	² 13.9	28.12
Total.....	13,983	13.4	5.5	220,300	14.0	15.75
Manchester:						
Passenger cars.....	11,258	¹ 12.9	6.8	148,300	¹ 13.0	13.17
Trucks and busses.....	1,901	² 11.1	40.4	54,900	² 12.8	28.88
Total.....	13,159	12.6	5.8	203,200	12.9	15.44
State totals:						
Passenger cars.....	87,217	83.6	5.3	1,139,700	72.6	13.07
Trucks and busses.....	17,166	16.4	27.1	429,800	27.4	25.04
Total.....	104,383	100.0	4.5	1,569,500	100.0	15.04

¹ Percentage of State total for passenger cars.
² Percentage of State total for trucks and busses.

almost 50 percent greater than the consumption per passenger car. This was caused by both the lower mileage per gallon obtained and the greater distances traveled by the trucks and busses.

Table 11 shows the total travel in vehicle-miles, and total gasoline consumption in gallons, for passenger

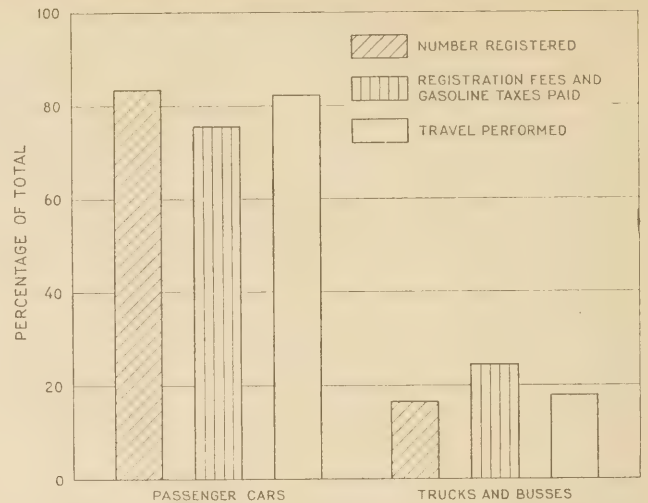

FIGURE 4.—PERCENTAGE DISTRIBUTION OF ALL VEHICLES BY NUMBER REGISTERED, REGISTRATION FEES AND GASOLINE TAXES PAID, AND TRAVEL PERFORMED.

cars and trucks and busses, distributed by place of ownership. These data were derived from the previously established data on registrations, average gasoline consumption, and average mileage traveled. Figures 3 and 4 show interesting relations regarding passenger cars and trucks and busses.

TABLE 10.—Average mileage traveled and average gasoline consumption per motor vehicle in 1932, by place of ownership

Place of ownership	Average gasoline consumption			Average mileage traveled		
	Passenger cars	Trucks and busses	All vehicles	Passenger cars	Trucks and busses	All vehicles
Rural areas.....	<i>Gallons</i> 452	<i>Gallons</i> 722	<i>Gallons</i> 503	<i>Miles</i> 6,639	<i>Miles</i> 7,675	<i>Miles</i> 6,836
Places to 2,499.....	510	696	541	7,333	7,034	7,305
Places 2,500 to 14,999.....	516	727	548	7,090	8,101	7,245
Places 15,000 to 74,999.....	595	893	640	7,686	8,763	7,850
Manchester.....	606	992	662	8,402	10,321	8,679
Average.....	521	769	562	7,281	8,063	7,410

¹ The gasoline consumption per registered vehicle is reported in the Taxation of Motor Vehicles in 1932 as 622 gallons. In deriving this figure no allowance was made for gasoline consumed by tourists. New Hampshire has a large amount of summer tourist travel. The proportion of gasoline consumed by out-of-State cars is increased by the light winter travel by all classes of traffic.

From tables 9 and 11, a comparison can be made between the distribution of vehicles in the various places and the travel performed by them. For example, in Manchester there were registered 12.6 percent of all of the vehicles in the State; and of the total travel on all highways and streets during the year, 14.8 percent was done by these vehicles. Rural areas contained 25.8 percent of all the vehicles in the State and performed 23.8 percent of the total travel by all vehicles in the State exclusive of travel by nonresidents.

A constitutional limitation places the levying of a tax on the privilege of selling gasoline outside of legislative power. It is possible, however, for the State to charge for the use of the public works it has built. Under this interpretation the State can levy a road toll. Since the amount of gasoline used is a measure of the use of the highways, the road toll is raised through a tax on gasoline. For all practical purposes this tax is like all other State gasoline taxes and is so considered in this survey.

TABLE 11.—*Mileage traveled, gasoline consumption, and gasoline-tax payments by passenger cars and by trucks and busses, distributed by place of ownership*

[Exclusive of nonresidents]

Place of ownership	Registra- tions	Total travel		Total gaso- line con- sumption	Total gasoline tax paid		
		Vehicle-miles	Percent		Amount	Percent	Amount per vehicle
Rural areas:							
Passenger cars.....	21,811	144,800,000	¹ 22.8	9,865,000	\$394,600	16.9	\$18.09
Trucks and busses.....	5,100	39,100,000	² 23.2	3,685,000	147,400	6.3	28.90
Total.....	26,911	183,900,000	23.8	13,550,000	542,000	23.2	20.14
Places to 2,499:							
Passenger cars.....	19,140	140,400,000	¹ 22.1	9,685,000	387,400	16.5	20.24
Trucks and busses.....	3,852	27,100,000	² 19.6	2,625,000	105,000	4.5	27.26
Total.....	22,992	167,500,000	21.6	12,310,000	492,400	21.0	21.42
Places 2,500 to 14,999:							
Passenger cars.....	23,159	164,200,000	¹ 25.9	11,952,500	478,100	20.4	20.64
Trucks and busses.....	4,179	33,900,000	² 24.5	3,040,000	121,600	5.2	29.10
Total.....	27,338	198,100,000	25.6	14,992,500	599,700	25.6	21.94
Places 15,000 to 74,999:							
Passenger cars.....	11,849	91,100,000	¹ 14.3	7,047,500	281,900	12.0	23.79
Trucks and busses.....	2,134	18,700,000	² 13.5	1,907,500	176,300	3.3	35.75
Total.....	13,983	109,800,000	14.2	8,955,000	358,200	15.3	25.62
Manchester:							
Passenger cars.....	11,258	94,600,000	¹ 14.9	6,822,500	272,900	11.7	24.24
Trucks and busses.....	1,901	19,600,000	² 14.2	1,885,000	75,400	3.2	39.66
Total.....	13,159	114,200,000	14.8	8,707,500	348,300	14.9	26.47
State total:							
Passenger cars.....	87,217	635,100,000	82.1	45,372,500	1,814,900	77.5	20.81
Trucks and busses.....	17,166	138,400,000	17.9	13,142,500	525,700	22.5	30.62
Total.....	104,383	773,500,000	100.0	58,515,000	2,340,600	100.0	22.42

¹ Percentage of total for passenger cars.

² Percentage of total for trucks and busses.

The total (net after refunds) receipts from the gasoline tax were \$2,638,800. The residents of New Hampshire paid \$2,340,600 and nonresidents paid \$298,200. The gasoline tax was second only to property taxes as a source of revenue, and was the largest item of the motor-vehicle receipts. The cost of administering the gasoline tax was only \$3,600.

The 1932 gasoline tax rate was 4 cents per gallon, composed of a tax of 3 cents per gallon, the proceeds to be used for general highway expenditures on the State highway system, and a tax of 1 cent per gallon, the revenue to be used by the State exclusively for highway debt service. As was found for license fees, the larger the community the greater was the gasoline tax paid per vehicle.

The average gasoline tax paid by trucks and busses was \$30.62 per vehicle, or nearly 50 percent greater than that paid by passenger cars. The average gasoline tax for all motor vehicles was \$22.42 per vehicle.

Table 11 shows that, on the average, trucks and busses paid in gasoline taxes \$9.81 more than passenger cars. The excess of the average license fee for trucks and busses over that for passenger cars was \$11.97, making a total excess of \$21.78. Since there were 17,166 trucks and busses licensed in the State, the amount of user revenues paid by trucks and busses was approximately \$370,000 more than that paid by an equal number of passenger cars.

Trucks and busses contributed 17.9 percent of the travel and paid 22.5 percent of the gasoline taxes.

MISCELLANEOUS MOTOR-VEHICLE IMPOSTS

In lieu of the personal-property tax formerly charged against motor vehicles, a local permit fee has been sub-

stituted and is a prerequisite to registration. Motor-vehicle owners who pay the permit fee are exempt from the property tax. Those vehicles not reached by the permit fee, however, such as cars in the hands of dealers, are still charged with the personal-property tax.

The revenues from the fees go to the local communities in the same manner that general property revenues do, and the money is used for the general purposes of the town. Although received from motor-vehicle owners and consequently highway users, it is not specifically dedicated for highway purposes. In 1932, however, \$91,000 or 17.7 percent of the \$513,000 collected in permit fees was used for highway purposes. Permit fees paid by persons living in unorganized areas go into the county fund.

The average permit fee in urban communities was higher than in rural areas and the fee was highest in Manchester, the average there being \$8.05 per vehicle. It is not surprising that the permit fee, being based on value and on the age of the vehicle, was higher in the urban communities than in the rural, since the newer, more valuable vehicles are owned in the places of greatest population.

Besides the registration fees, local permit fees, and gasoline taxes, there are a number of other imposts levied specifically on motor vehicles and their operators. Among these are drivers' and chauffeurs' licenses, transfer fees, manufacturers' and dealers' fees, and fines and penalties similar to those collected in other States. These are incidental fees of minor importance, collected in connection with the operation of the laws and regulations in the State. The total of these imposts in 1932 was \$395,100, of which \$356,500 was contributed by residents of New Hampshire.

TABLE 12.—Average and total payments of motor-vehicle fees and gasoline taxes by owners of motor vehicles in 1932, distributed by place of ownership¹

Place of ownership	Payments per vehicle					Total payments					
	Registration fees	Gasoline tax	Miscellaneous imposts	Local permit fees	Total	Registration fees	Gasoline tax	Miscellaneous imposts	Local permit fees	Total	Percentage of total
Rural areas.....	\$14.21	\$20.14	\$3.48	\$4.21	\$42.04	\$382,500	\$542,000	\$93,700	\$113,400	\$1,131,600	23.7
Places to 2,499.....	14.83	21.42	3.42	4.64	44.34	341,700	492,400	78,700	106,700	1,019,500	21.3
Places 2,500 to 14,999.....	15.43	21.94	3.34	4.27	44.98	421,800	599,700	91,400	116,700	1,229,600	25.7
Places 15,000 to 74,999.....	15.75	25.62	3.41	5.03	49.81	220,300	358,200	47,700	70,300	696,500	14.6
Manchester.....	15.44	26.47	3.42	8.05	53.38	203,200	348,300	45,000	105,900	702,400	14.7
Total or average.....	15.04	22.42	3.42	4.91	45.79	1,569,500	2,340,600	356,500	513,000	4,779,600	100.0

¹ Excludes payments by nonresidents.

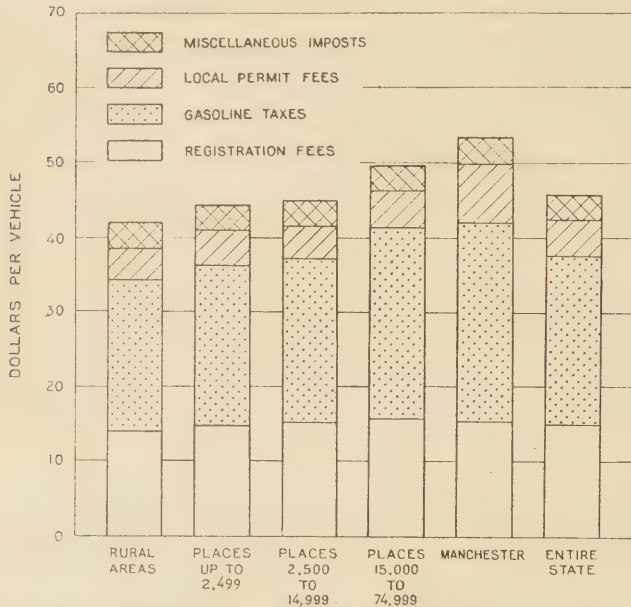

FIGURE 5.—AVERAGE MOTOR-VEHICLE IMPOSTS AND GASOLINE TAXES PAID BY MOTOR-VEHICLE OWNERS, DISTRIBUTED BY PLACE OF OWNERSHIP.

DATA ON MOTOR-VEHICLE TAXES AND TRAVEL SUMMARIZED

Table 12 summarizes the data on average registration fees and gasoline taxes paid in 1932. The total additional charges made against motor-vehicle owners are also shown. These data are presented graphically in figure 5.

Table 13 summarizes the relations between population, vehicles registered, registration fees and gasoline taxes paid, and travel performed, data that have been given in preceding paragraphs. Figure 6 shows the relations between registrations, contribution to highway taxes, and travel performed.

The following conclusions regarding motor vehicles, their taxation and travel, can be drawn:

1. The rural areas with 25.8 percent of the population contained 25.8 percent of the registered motor vehicles. Motor-vehicle owners in the rural areas paid 23.7 percent of the motor-vehicle imposts collected and contributed 23.8 percent of the total travel performed by New Hampshire vehicles.

2. The urban communities with 74.2 percent of the population contained 74.2 percent of the registered motor vehicles. Motor-vehicle owners in these urban areas paid 76.3 percent of the motor-vehicle imposts collected and contributed 76.2 percent of the total travel performed by residents,

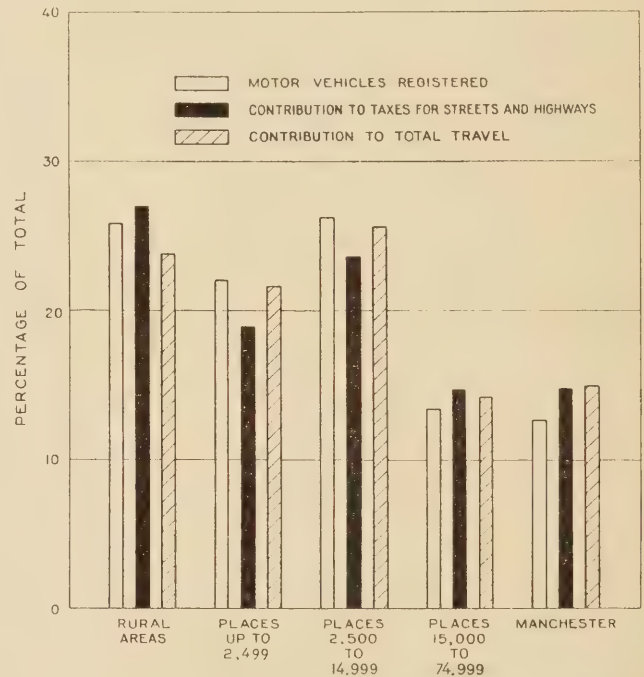

FIGURE 6.—PERCENTAGE DISTRIBUTION OF MOTOR VEHICLES REGISTERED, ALL MOTOR-VEHICLE IMPOSTS PAID, AND CONTRIBUTION TO TOTAL TRAVEL, DISTRIBUTED BY GOVERNMENTAL UNITS.

3. The average registration fee paid was \$15.04; the average gasoline tax was \$22.42; the average miscellaneous motor-vehicle tax was \$3.42; the average local permit fee was \$4.91; and the total payment was \$45.79 per vehicle in user revenues. Both registration fees and gasoline tax payments per vehicle were found to increase as the place of residence became more densely settled.

4. The average registration fee paid was \$13.07 for passenger cars and \$25.04 for trucks and busses. The average gasoline tax paid was \$20.81 by passenger-car owners and \$30.62 by owners of trucks and busses. The average payment per vehicle for registration fees and gasoline taxes was \$33.88 for passenger cars, \$55.66 for trucks and busses, and the average for all vehicles was \$37.46.

5. Trucks and busses contributed 16.4 percent of the total registrations and 17.9 percent of the total travel by New Hampshire vehicles and paid 27.4 percent of the registration fees and 22.5 percent of the gasoline taxes.

TABLE 13.— Comparison of the several classes of local governmental units as to population, motor vehicles registered, motor-vehicle taxes paid, and share of total travel performed by vehicles owned in these places

Unit of government	Population	Motor vehicles registered	Registration fees paid	Gasoline taxes paid	Registration fees and gasoline taxes paid	All motor-vehicle imposts paid	Contribution to total travel
	Pct.	Pct.	Pct.	Pct.	Pct.	Pct.	Pct.
Rural areas	25.8	25.8	24.4	23.2	23.7	23.7	23.8
Places to 2,499	17.3	22.0	21.8	21.0	21.3	21.3	21.6
Places 2,500 to 14,999	23.9	26.2	26.9	25.6	26.1	25.7	25.6
Places 15,000 to 74,999	16.5	13.4	14.0	15.3	14.8	14.6	14.2
Manchester	16.5	12.6	12.9	14.9	14.1	14.7	14.8
Total	100.0	100.0	100.0	100.0	100.0	100.0	100.0

BONDED INDEBTEDNESS FOR HIGHWAYS ABOUT 40 PERCENT OF TOTAL

The total bonded indebtedness for all units of government in New Hampshire at the end of 1932 amounted to \$26,131,000. Of this amount \$10,242,000, or 39.2 percent, was incurred for highways and streets; \$5,833,400, or 22.3 percent, was for education; \$7,884,100, or 30.2 percent, was for public benefit; and \$2,171,500, or 8.3 percent, was for governmental purposes. In New Hampshire as in other States, the extensive highway program was responsible for a large portion of the public debt. Table 14 shows the bonded indebtedness classified by purpose and by governmental unit.

The bonded indebtedness of the State government comprised \$7,841,000, or 30 percent of the total. Of this amount, 67.6 percent, or \$5,300,000, was for highway purposes. The entire State highway debt consisted of three series of bond issues—the New Hampshire flood bonds, the permanent improvement bonds, and the trunk-line completion bonds.

The New Hampshire flood bonds, authorized in 1927 for an amount not to exceed \$3,000,000, were issued for the construction and reconstruction of the highways damaged or destroyed by floods in 1927.

A permanent highway bond issue was authorized in 1929 for the construction and reconstruction of trunk-line highways. The total issue was not to exceed \$8,000,000.

The proceeds from the additional gasoline tax of 1 cent per gallon are used to service both of these issues.

Trunk-line completion bonds not to exceed \$750,000 in amount were authorized in 1929 to provide " * * * for the assistance of cities and towns in the completion of the permanent improvement of existing trunk lines." It was in effect a loan to towns

TABLE 14.— Bonded indebtedness as of Dec. 31, 1932, classified by purpose of issue and by unit of government

BY PURPOSE			
	Amount	Percentage of total	Amount per capita
Highways and streets	\$10,242,000	39.2	\$22.01
Education	5,833,400	22.3	12.54
Public benefit	7,884,100	30.2	16.94
Government	2,171,500	8.3	4.67
Total	26,131,000	100.0	56.16
BY UNIT OF GOVERNMENT			
State	\$7,841,000	30.0	\$16.85
Counties	932,500	3.6	2.00
Rural areas	2,316,700	8.8	19.26
Urban communities	15,040,800	57.6	43.59
Total	26,131,000	100.0	56.16

to enable them to defray their share of the cost of completing the gaps in the trunk-line highway system.

NEW HAMPSHIRE EXPENDITURES IN 1932

The total expenditures for all purposes (exclusive of principal payments on bonds and loans) by all units of government in New Hampshire in 1932 were \$28,298,000, of which \$9,129,200 was expended for highways and streets, \$7,624,500 for education, \$9,867,000 for public benefit, and \$1,677,300 for other governmental purposes.

Expenditures by the State were \$10,242,200; by the counties, \$2,166,300; by incorporated places, \$11,229,600; and by rural areas, \$4,659,900.

Of the total expenditures, 40.3 percent was made in rural areas; 13.2 percent in incorporated places to 2,499 population; 19.1 percent in places with 2,500 to 14,999 population; 14.7 percent in places with 15,000 to 74,999 population; and 12.7 percent in Manchester.

city of Manchester. The per-capita debt contracted by the counties was \$2; by the State, \$16.85.

Debt service consists of interest and principal payments on indebtedness. The total debt-service payments in 1932 were \$5,464,400, of which \$1,638,600, or 30 percent, was for highways. Contrary to the usual situation, in New Hampshire the percentage of debt service for each of the purposes differed considerably from the percentage of outstanding indebtedness for the same purpose.

For the entire State nearly four-fifths of the debt service consisted of principal payments, and the balance was interest. State payments, however, showed a higher proportion of principal payments, amounting to almost 88 percent of the total debt service on State debts. Table 15 shows these figures for Manchester and for the rest of the State.

The State also issued bonds in the amount of \$1,541,000 for public benefit purposes and \$1,000,000 for other governmental purposes. There was no State bonded debt for education.

The county indebtedness amounted to only \$932,500, all of which was incurred for public benefit.

The urban communities had a total indebtedness of \$15,040,800, or 57.6 percent of the total. Over 27 percent of this was incurred for highways and streets.

Of the total indebtedness of \$2,316,700 incurred by the rural areas, 36.2 percent, or \$839,400, was for highway purposes.

The per-capita debt ranged from \$19.26 in the rural areas to \$54.84 in the

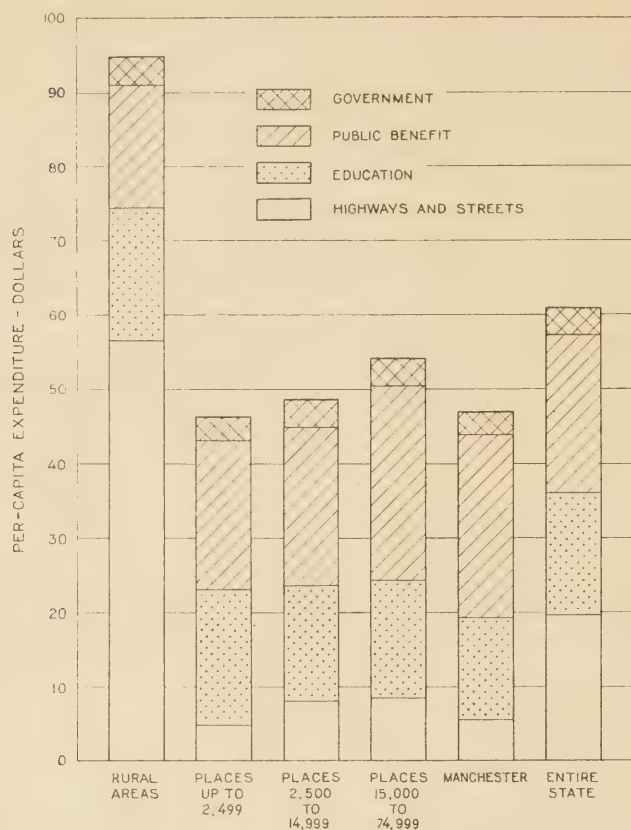

FIGURE 7.—PER-CAPITA EXPENDITURES FOR DIFFERENT PURPOSES, DISTRIBUTED BY GOVERNMENTAL UNITS WHERE EXPENDITURES WERE MADE.

TABLE 15.—Payments for debt service in 1932

Unit of government	Principal	Interest	Total
State:			
Total amount	\$2,115,000	\$296,900	\$2,411,900
Per-capita amount	4.54	0.64	5.18
Manchester:			
Total amount	739,700	288,000	1,027,700
Per-capita amount	9.63	3.75	13.38
Balance of State:			
Total amount	1,476,400	548,400	2,024,800
Per-capita amount	3.80	1.41	5.21
All governmental units:			
Total amount	4,331,100	1,133,300	5,464,400
Per-capita amount	9.31	2.43	11.74

HIGHWAY EXPENDITURES NEARLY \$20 PER CAPITA

The total expenditure by all units of government for all purposes in 1932 was \$28,298,000, equal to \$60.82 per capita. Table 16 shows that the largest amount per capita, \$21.21, was for public benefit. The amount spent for this purpose was \$9,867,000, or 34.9 percent of the total. For highways and streets, 32.3 percent, or \$9,129,200, was spent; for education, 26.9 percent, or \$7,624,500; and for government, 5.9 percent, or \$1,677,300. The total amount includes \$1,133,300 of interest payments on funded debt.

The State spent \$10,242,000, or 36.2 percent, of the total expenditures. Of this amount 57.6 percent, or \$5,895,100, was spent for highways and streets; 27.9 percent, or \$2,855,500, for public benefit; 12.3 percent, or \$1,263,900, for education; and 2.2 percent, or \$227,700, for government.

The \$4,331,100 of principal payments is excluded, as it represents repayments of funds charged as expenditures in previous years.

TABLE 16.—Classification of the total expenditures in 1932 by the State, the counties, and the local units of government, and per-capita expenditures by purpose

Expended by—	Total expenditure		Per-capita expenditures for—				
	Amount	Per cent	Highways and streets	Edu-cation	Public benefit	Gov-ernment	Total
State.....	\$10,242,200	36.2	\$12.67	\$2.72	\$6.13	\$0.49	\$22.01
Counties.....	2,166,300	7.6			4.41	.25	4.66
Rural areas.....	4,659,900	16.5	14.12	15.18	6.43	3.02	38.75
Places to 2,499.....	2,336,200	8.3	1.41	15.54	9.50	2.60	29.05
Places 2,500 to 14,999.....	3,601,400	12.7	5.00	12.84	11.49	3.10	32.43
Places 15,000 to 74,999.....	2,854,700	10.1	6.58	13.17	14.42	3.04	37.21
Manchester.....	2,437,300	8.6	4.70	11.06	13.64	2.42	31.72
Total.....	28,298,000	100.0	19.62	16.39	21.21	3.60	60.82

TABLE 17.—Comparison of expenditures by governmental units for various purposes

DISTRIBUTION BY PURPOSE

Expended by—	Highways and streets	Educa-tion	Public benefit	Gov-ernment	All pur-poses
	Percent	Percent	Percent	Percent	Percent
State.....	57.6	12.3	27.9	2.2	100.0
Counties.....			94.7	5.3	100.0
Rural areas.....	36.4	39.2	16.6	7.8	100.0
Places to 2,499.....	4.8	53.5	32.7	9.0	100.0
Places 2,500 to 14,999.....	15.4	39.6	35.4	9.6	100.0
Places 15,000 to 74,999.....	17.7	35.4	38.7	8.2	100.0
Manchester.....	14.8	34.9	42.7	7.6	100.0
Total.....	32.3	26.9	34.9	5.9	100.0

DISTRIBUTION BY GOVERNMENTAL UNIT

State.....	64.6	16.6	28.9	13.6	36.2
Counties.....			20.8	6.8	7.6
Rural areas.....	18.6	23.9	7.8	21.6	16.5
Places to 2,499.....	1.2	16.4	7.8	12.5	8.3
Places 2,500 to 14,999.....	6.1	18.7	12.9	20.5	12.7
Places 15,000 to 74,999.....	5.5	13.3	11.2	13.9	10.1
Manchester.....	4.0	11.1	10.6	11.1	8.6
Total.....	100.0	100.0	100.0	100.0	100.0

The counties, which are of relative unimportance from the standpoint of total expenditures, expended only \$2,166,300, nearly all of which was for public benefit. No expenditures were made by the counties for education or for highways and streets.

The rural areas spent \$4,659,900, or approximately 16.5 percent of all expenditures made in the State. Almost 40 percent of this amount was expended for educational purposes and more than 36 percent was for highways.

A large amount of the \$11,229,600 expended by the urban areas was for public benefit. The per-capita expenditures for this purpose ranged from \$9.50 to \$14.42. The per-capita expenditure for highways and streets in the urban places was much less than in the rural areas. Expenditures for government were fairly uniform throughout all localities.

Table 17 shows data on expenditures made by each unit of government for the various purposes. The top half of this table divides the expenditures made by each governmental agency according to the purpose for which it was made. The bottom half of the table divides the expenditures for each purpose according to the amount expended by each unit of government.

To allocate the expenditures as finally made in the rural and urban areas, it was necessary to distribute

the State and county expenditures as made for the residents in these territories.

Table 18 and figure 7 show these data on a per-capita basis. It is apparent that the total per-capita cost of the activities carried on by and in governmental units was less in urban than in rural areas. This is contrary to the condition usually found in other States. The metropolitan areas with their expensive public services necessary to the welfare of large numbers of people living in a small territory usually have a higher per-capita public cost than in places where the public demands are less intense. In general this was also true of New Hampshire, but the total was affected by the heavy State highway expenditures in the rural areas. Although these funds were expended outside of urban places, they were a benefit to the entire traveling public of the State and should not be construed as a subsidy to the place where spent.

HIGHWAY AND STREET EXPENDITURES ANALYZED

In 1932, \$9,129,200 was expended upon all highways and streets in New Hampshire. Of this, \$6,798,300, or 74.5 percent, was spent in rural areas and \$2,330,900, or 25.5 percent, in urban areas. These were the actual current expenditures for 1932, including interest upon indebtedness, but not payment of principal on the highway debt. It is particularly important to exclude the payment of principal on debt, otherwise a duplication of cost items results. It is also necessary to avoid duplication of expenditures

RELATIONS BETWEEN HIGHWAY TAXES PAID, HIGHWAY EXPENDITURES, AND TRAVEL

There were 11,750 miles of rural highways in New Hampshire in 1932. The State highway system consisted of 3,033 miles, divided into 1,596 miles of State highways and 1,437 miles of State-aid roads. There were 8,717 miles of local roads and 561 miles of urban streets.

The total travel (exclusive of that performed by vehicles owned by nonresidents) on all highways and streets in New Hampshire during the year 1932 was approximately 774 million vehicle-miles, of which 23.8 percent was performed by vehicles of rural ownership; 21.6 percent by vehicles owned in incorporated places having a population to 2,499; 25.6 percent by vehicles owned in places of 2,500 to 14,999 population; 14.2 percent by vehicles owned in places of 15,000 to 74,999 population; and 14.8 percent by vehicles owned in Manchester.

Expenditures on State highways in 1932 were \$3,461,100; on the State-aid system, \$2,723,200; on the local town roads, \$1,409,500; and on urban streets, \$1,535,400.

Of the total property taxes expended on all roads and streets, 11.5 percent was expended on State and State-aid highways, 38.8 percent on the local town roads, and 49.7 percent on urban streets.

Of the total motor-vehicle taxes, including nonresident fees, expended on all highways and streets, 40.9 percent was expended on State highways; 55.2 percent on State-aid roads; 3.9 percent on the local town roads; and none on urban streets.

Of the total of all taxes and imposts expended on all roads and streets, rural property and motor-vehicle owners paid 32 percent, and travel by rural vehicles made up 23.8 percent of the total travel on all roads and streets; property and motor-vehicle owners in urban areas paid 61.8 percent, and travel by urban vehicles made up 76.2 percent of the total travel. Out-of-State residents contributed 6.2 percent of the imposts. The amount of travel they performed is unknown.

caused by the transfer of funds from one governmental unit to another. The highway and other cost figures in this report are the actual current costs with all duplications eliminated.

On the class 1 roads, \$3,278,500 was expended in 1932. This was exclusive of interest payments on funded debt. Of this amount \$1,692,600 was spent for construction, \$1,396,000 for maintenance, and \$189,900 for departmental overhead. Of the total, \$2,827,300, or 86.2 percent, was expended in rural areas.

New Hampshire follows the policy of paying for the cost of its trunk highways out of user revenues and for this purpose derives funds primarily from gasoline taxes and license fees. In addition, \$1,000,000 from bond sales and \$371,400 of Federal-aid funds were available for the 1932 program. After paying the cost of administration, the proceeds from the 3-cent gasoline tax and the license fees are for use by the State highway department. The net sum so designated was \$3,755,300, of which \$1,493,300, or almost 40 percent, was used upon the State trunk-line highway system.

Upon the class 2 or State-aid roads, \$2,723,200 was expended, of which \$1,605,100 was for construction, \$998,000 for maintenance, and \$120,100 for overhead. Of the \$1,605,100 spent for construction, \$937,800 was

for the emergency construction program. The interest charges incidental to the State road systems were \$182,600. The total cost of the State road systems, therefore, amounted to \$6,184,300. Table 19 shows the construction and maintenance expenditures on the system.

TABLE 18.—Comparison of per-capita expenditures by purpose and by classes of local units where the expenditures were made

Expended in—	Highways and streets	Educa-tion	Public benefit	Government	Total
Rural areas.....	\$56.53	\$17.91	\$16.68	\$3.75	\$94.87
Places to 2,499.....	4.72	18.25	20.00	3.35	46.32
Places 2,500 to 14,999.....	8.02	15.52	21.33	3.85	48.72
Places 15,000 to 74,999.....	8.37	15.92	26.04	3.80	54.13
Manchester.....	5.46	13.78	24.54	3.08	46.86
Average for State.....	19.62	16.39	21.21	3.60	60.82

The local communities expended a total of \$3,234,100 upon all highway and street programs, and of this amount \$2,944,900 was expended locally upon the town roads and streets. Of this total, \$146,600 went for construction, \$2,290,600 for maintenance, and \$507,700 for general overhead. This is not the complete overhead charge, as the amounts paid to the local road agencies could not be segregated.

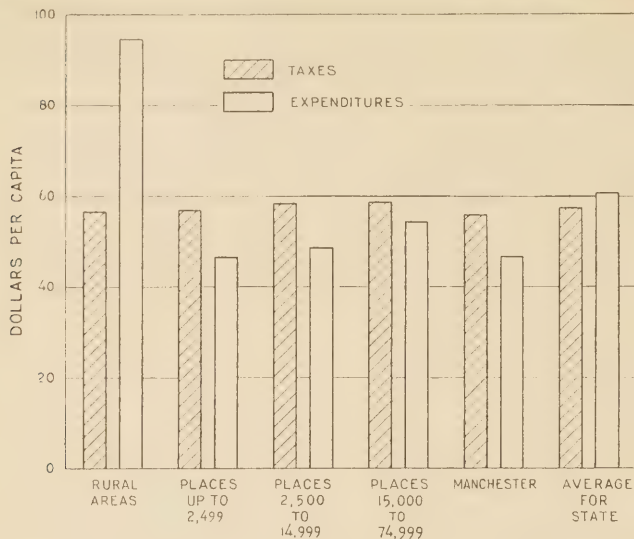

FIGURE 8.—PER-CAPITA TAXES AND EXPENDITURES IN THE SEVERAL CLASSES OF LOCAL UNITS AND IN THE STATE AS A WHOLE.

TABLE 19.—Expenditures for construction and maintenance on the State highway system in 1932

Highway system	Construction		Maintenance		Total		Percentage of total construction and maintenance
	Amount	Per-cent	Amount	Per-cent	Amount	Per-cent	
State (class 1).....	\$1,692,600	54.8	\$1,396,000	45.2	\$3,088,600	100.0	54.3
State aid (class 2).....	1,605,100	61.7	998,000	38.3	2,603,100	100.0	45.7
Total.....	3,297,700	57.9	2,394,000	42.1	5,691,700	100.0	100.0

Except for a small amount of State aid to some of the rural communities, the local roads were financed entirely from local revenues. Even the class 4 roads on the State numbered system in cities were financed by the places through which they pass. New Hampshire does not have a special property tax for highways. All of the public receipts are placed in the common fund from which expenditures for all purposes are made. Therefore, local highway costs are met by a tax on property only in the proportion that the property tax bears to the total local receipts.

The combined expenditures by the State and local governments for roads in rural areas amounted to \$6,798,300; for highways and streets in urban communities, \$2,330,900. A comparison of these expenditures with the taxes imposed in the various areas for highway and street purposes is shown in table 20. The figures on the ratio of expenditures to taxes do not accurately portray the current highway picture, because a substantial portion of the taxes levied in 1932 was not expended for the 1932 highway program.

There was a flow of revenue from the urban to the rural areas. It is not to be inferred that such transfer of funds is unwarranted, nor that an undue benefit is necessarily conferred upon the community where spent. The highway funds are used for constructing rural roads that serve all of the people in the State. If the roads so built serve the transportation needs of residents of urban communities, then logically the funds should be derived in due proportion from all of the communities benefited.

TABLE 20.—Comparison of highway and street expenditures and taxes in the several classes of local units in 1932

Class of local unit	Highway and street expenditures		Highway and street taxes		Ratio of expenditures to taxes
	Amount	Percent	Amount	Percent	
Rural areas.....	\$6,798,300	74.5	\$2,150,000	27.9	1:0.3
Places to 2,499.....	379,200	4.1	1,459,800	18.9	1:3.9
Places 2,500 to 14,999.....	890,500	9.8	1,826,500	23.7	1:2.1
Places 15,000 to 74,999.....	641,600	7.0	1,162,200	15.1	1:1.8
Manchester.....	419,600	4.6	1,113,400	14.4	1:2.7
Total.....	9,129,200	100.0	7,711,900	100.0	1:0.8

TOTAL EXPENDITURES EXCEED TAXATION BY \$3.65 PER CAPITA

Table 21 and figure 8 indicate that there is a flow of funds to the less populous areas. The per-capita expenditures in the rural areas exceeded the per-capita taxation by \$38.57. The expenditures in the urban areas, on the other hand, were less than taxes.

The amount of imposts received and expenditures made do not balance, primarily because of the effect of financing current costs from borrowings, balances, and reserves. Taxes, therefore, always lag behind expenditures.

Tables 22, 23, and 24 give rather comprehensive figures that make possible many comparisons concerning the flow of funds between urban and rural communities. For example, referring to tables 22 and 23, \$11,409,500 was expended in the rural areas by all governmental agencies, while the rural areas paid \$6,769,900 in taxes. The per-capita expenditure in rural areas was \$94.87, while the per-capita tax paid was \$56.30. Of the total expenditure in rural areas, 40.8 percent was made by the local town governments, and 59.2 percent in or for the towns by the State and counties, primarily for highway purposes. This indicates a large flow of funds for highway purposes from the urban communities to the rural communities, the State and county spending \$5,099,600, in the rural areas while these same areas contributed but \$1,018,200.

Table 25 shows the relations between governmental units and population, motor-vehicle ownership, property valuation, taxes paid, and expenditures made in 1932.

TABLE 21.—Comparison of per-capita property valuation, taxation, and expenditures in 1932, in the various classes of local units and in the entire State

Unit of government	Per-capita property valuation	Per-capita taxation	Per-capita expenditures	Ratio of expenditures to taxation
Rural.....	\$1,524	\$56.30	\$94.87	1:0.6
Places to 2,499.....	1,185	56.69	46.32	1:1.2
Places 2,500 to 14,999.....	1,250	58.16	48.72	1:1.2
Places 15,000 to 74,999.....	1,301	58.79	54.13	1:1.1
Manchester.....	1,382	55.98	46.86	1:1.2
Average for State.....	1,340	57.17	60.82	1:0.9

SOURCES OF FUNDS SPENT ON HIGHWAYS AND STREETS ANALYZED

The sources of revenue for expenditure on the various highway and street systems, classified both by agency providing the funds and by type of fund, are shown in table 26. Of the \$9,129,200 spent on all highways and streets in the State, 4.1 percent, or \$371,400, was provided by Federal aid, all of which was expended on the State highways. The State provided 62.2 percent of

TABLE 22.—Classification of all taxes as levied against and paid by residents of rural and urban areas

Area and type of impost	Tax-levying agency								
	Local governments			State and county governments			All governments		
	Amount	Percent	Amount per capita	Amount	Percent	Amount per capita	Amount	Percent	Amount per capita
Rural areas:									
Property.....	\$3,557,400	85.6	\$29.58	\$723,000	27.6	\$6.01	\$4,280,400	63.2	\$35.59
Other.....	596,100	14.4	4.96	1,893,400	72.4	15.74	2,489,500	36.8	20.70
Total.....	4,153,500	100.0	34.54	2,616,400	100.0	21.75	6,769,900	100.0	56.29
Urban areas:									
Property.....	10,288,400	82.7	29.82	1,774,100	24.0	5.14	12,062,500	60.8	34.96
Other.....	2,145,000	17.3	6.22	5,621,800	76.0	16.29	7,766,800	39.2	22.51
Total.....	12,433,400	100.0	36.04	7,395,900	100.0	21.43	19,829,300	100.0	57.47
Entire State:									
Property.....	13,845,800	83.5	29.76	2,497,100	24.9	5.37	16,342,900	61.4	35.13
Other.....	2,741,100	16.5	5.89	7,515,200	75.1	16.15	10,256,300	38.6	22.04
Total.....	16,586,900	100.0	35.65	10,012,300	100.0	21.52	26,599,200	100.0	57.17

TABLE 23.—Classification of total expenditures by purpose as made by all units of government

Area and purpose	Unit of government								
	Local governments			State and county governments			All governments		
	Amount	Percent	Amount per capita	Amount	Percent	Amount per capita	Amount	Percent	Amount per capita
Rural areas:									
Highways and streets.....	\$1,698,700	36.4	\$14.12	\$5,099,600	75.5	\$42.41	\$6,798,300	59.6	\$56.53
Education.....	1,825,000	39.2	15.18	328,300	4.9	2.73	2,153,300	18.9	17.91
Public benefit.....	773,100	16.6	6.43	1,233,200	18.3	10.25	2,006,300	17.6	16.68
Government.....	363,100	7.8	3.02	88,500	1.3	.73	451,600	3.9	3.75
Total.....	4,659,900	100.0	38.75	6,749,600	100.0	56.12	11,409,500	100.0	94.87
Urban areas:									
Highways and streets.....	1,535,400	13.7	4.45	795,500	14.1	2.31	2,330,900	13.8	6.76
Education.....	4,535,600	40.4	13.15	935,600	16.5	2.71	5,471,200	32.4	15.86
Public benefit.....	4,186,300	37.3	12.13	3,674,400	64.9	10.65	7,860,700	46.5	22.78
Government.....	972,300	8.6	2.82	253,400	4.5	.73	1,225,700	7.3	3.55
Total.....	11,229,600	100.0	32.55	5,658,900	100.0	16.40	16,888,500	100.0	48.95
Entire State:									
Highways and streets.....	3,234,100	20.4	6.95	5,895,100	47.5	12.67	9,129,200	32.3	19.62
Education.....	6,360,600	40.0	13.67	1,263,900	10.2	2.72	7,624,500	26.9	16.39
Public benefit.....	4,959,400	31.2	10.66	4,907,600	39.5	10.55	9,867,000	34.9	21.21
Government.....	1,335,400	8.4	2.87	341,400	2.8	.73	1,677,300	5.9	3.60
Total.....	15,889,500	100.0	34.15	12,408,500	100.0	26.67	28,298,000	100.0	60.82

TABLE 24.—Classification of taxes used for highway and street purposes as levied against and paid by residents of rural and urban areas

Area and type of impost	Tax-levying agency								
	Local governments			State and county governments			All governments		
	Amount	Percent	Amount per capita	Amount	Percent	Amount per capita	Amount	Percent	Amount per capita
Rural areas:									
Property.....	\$978,400	86.4	\$8.14				\$978,400	45.5	\$8.14
Other.....	153,400	13.6	1.27	\$1,018,200	100.0	\$8.47	1,171,600	54.5	9.74
Total.....	1,131,800	100.0	9.41	1,018,200	100.0	8.47	2,150,000	100.0	17.88
Urban areas:									
Property.....	1,887,400	81.6	5.47				1,887,400	33.9	5.47
Other.....	426,100	18.4	1.24	3,248,400	100.0	9.41	3,674,500	66.1	10.65
Total.....	2,313,500	100.0	6.71	3,248,400	100.0	9.41	5,561,900	100.0	16.12
Entire State:									
Property.....	2,865,800	83.2	6.16				2,865,800	37.2	6.16
Other.....	579,500	16.8	1.24	4,266,600	100.0	9.17	4,846,100	62.8	10.41
Total.....	3,445,300	100.0	7.40	4,266,600	100.0	9.17	7,711,900	100.0	16.57

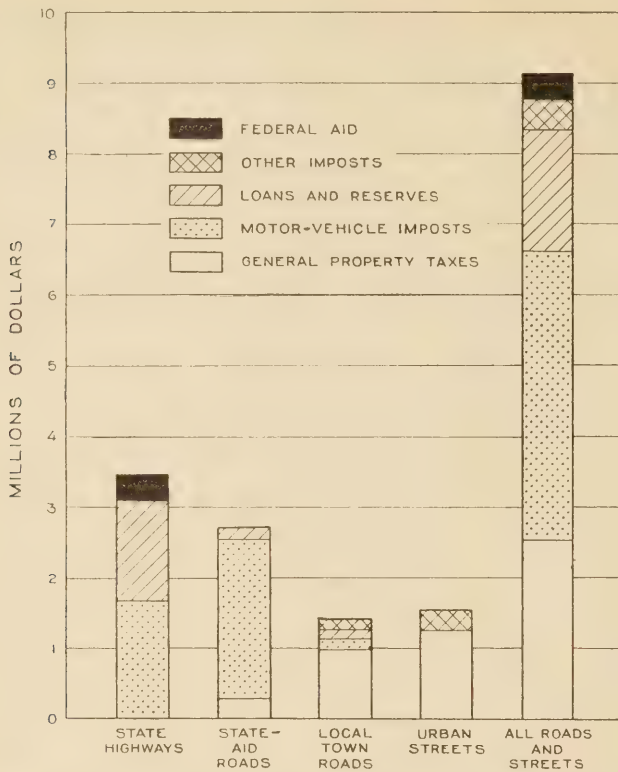

FIGURE 9.—Distribution of Total Expenditures for Highways and Streets, Showing Sources of Funds.

TABLE 25.—Distribution of population, motor-vehicle ownership, property valuation, taxes paid, and expenditures made in the several classes of local governmental units in 1932

Unit of government	Population	Motor-vehicle ownership	Property valuation	Taxes paid	Expenditures made
	Percent	Percent	Percent	Percent	Percent
Rural areas.....	25.8	25.8	29.4	25.4	40.3
Places to 2,499.....	17.3	22.0	15.3	17.1	13.2
Places 2,500 to 14,999.....	23.9	26.2	22.3	24.3	19.1
Places 15,000 to 74,999.....	16.5	13.4	16.0	17.0	14.7
Manchester.....	16.5	12.6	17.0	16.2	12.7
Total.....	100.0	100.0	100.0	100.0	100.0

the money expended on highways and streets. The remainder, \$3,072,900, was furnished by the local governments.

Only \$1,535,400 of current taxes was expended by the urban areas for the highway program in 1932, although the total taxes levied in 1932 for highway purposes by these communities amounted to \$2,313,500. The reasons for the difference between the taxes levied and the expenditures made for the current highway program were:

1. Additional levies were needed to meet the principal payments due on more than \$3,500,000 of municipal highway indebtedness. These payments are not included in the definition of expenditures used in these studies.
2. Taxes for streets in the municipalities included levies for purposes that are not included in our definition of highways, such as street lighting and street cleaning.
3. Tax delinquency caused a difference between the amount levied and the amount collected.

TABLE 26.—Funds expended on highways and streets in 1932, and the approximate amounts and percentages of these funds provided by imposts made by the various governmental units, and by loan and reserve funds

Highway system and form of revenue	Governmental agency providing funds				Percentage of total current tax funds	Percentage of total funds
	Federal Government	State	Local governments	Total		
State road system:						
State highways:					<i>Pct.</i>	<i>Pct.</i>
Loans or reserves.....		\$1,402,000		\$1,402,000		
Current taxes.....	\$371,400	\$1,675,900	\$11,800	\$2,059,100	27.7	
Total.....	\$371,400	\$3,077,900	\$11,800	\$3,461,100		37.9
Percentage distribution.....	10.7	88.9	0.4	100.0		
State-aid roads:						
Loans or reserves.....		\$183,800		\$183,800		
Current taxes.....		\$2,262,000	\$277,400	\$2,539,400	34.2	
Total.....		\$2,445,800	\$277,400	\$2,723,200		29.8
Percentage distribution.....		89.8	10.2	100.0		
Entire State system:						
Loans or reserves.....		\$1,585,800		\$1,585,800		
Current taxes.....	\$371,400	\$3,937,900	\$289,200	\$4,598,500	61.9	
Total.....	\$371,400	\$5,523,700	\$289,200	\$6,184,300		67.7
Percentage distribution.....	6.0	89.3	4.7	100.0		
Local rural roads:						
Loans or reserves.....			\$116,500	\$116,500		
Current taxes.....		\$161,200	\$1,131,800	\$1,293,000	17.4	
Total.....		\$161,200	\$1,248,300	\$1,409,500		15.5
Percentage distribution.....		11.4	88.6	100.0		
Urban streets:						
Loans or reserves.....						
Current taxes.....			\$1,535,400	\$1,535,400	20.7	
Total.....			\$1,535,400	\$1,535,400		16.8
Percentage distribution.....			100.0	100.0		
All highways and streets:						
Loans or reserves.....		\$1,585,800	\$116,500	\$1,702,300		
Current taxes.....	\$371,400	\$4,099,100	\$2,956,400	\$7,426,900	100.0	
Total.....	\$371,400	\$5,684,900	\$3,072,900	\$9,129,200		100.0
Percentage distribution.....	4.1	62.2	33.7	100.0		

¹ Total taxes levied for highways, \$2,313,500; only \$1,535,400 needed for current highway program.

Table 27 and figure 9 show the sources of revenue expended for highways and streets by type of impost and the amounts contributed for each of the systems by the residents of the rural and urban areas. The imposts on motor-vehicle owners include only license fees, gasoline taxes, and miscellaneous motor-vehicle imposts. It was impossible to segregate the proceeds from the permit fees used for highways. This amount, \$91,000, is included in the other imposts used for local roads and streets.

Table 28 is a summary of the taxes and expenditures in New Hampshire in 1932 based on data presented previously in this report. The \$1,000 unit is not identical for taxes and expenditures. To balance the tabulation exactly it would be necessary to include the proceeds from bonds and loans under taxes and principal payments under expenditures. The complete figures for such a presentation are not available. The table gives a helpful picture, however, of the relations between money received from imposts and the actual expenditures for the various purposes.

SUMMARY

1. Only 4.7 percent of the funds expended on State and State-aid roads was raised from taxes on property.
2. Rural property owners paid no tax for urban streets.

TABLE 27.—Amounts of the 1932 taxes and imposts expended on the current highway program, listed according to highway system, type of tax, and class of local unit in which the tax was paid

IMPOSTS ON GENERAL PROPERTY											
Paid by taxpayers in—	Highway system										Percent- age of total
	State roads		State-aid roads		Local town roads		Urban streets		All highways and streets		
	Amount	Percent	Amount	Percent	Amount	Percent	Amount	Percent	Amount	Percent	
Rural areas.....	\$10,100	0.8	\$233,500	19.1	\$978,400	80.1			\$1,222,000	100.0	48.5
Places to 2,499.....			300	.3			\$93,000	99.7	93,300	100.0	3.7
Places 2,500 to 14,999.....	1,700	.4	18,600	4.0			443,100	95.6	463,400	100.0	18.4
Places 15,000 to 74,999.....			25,000	5.6			423,200	94.4	448,200	100.0	17.8
Manchester.....							293,500	100.0	293,500	100.0	11.6
Total.....	11,800	.5	277,400	11.0	978,400	38.8	1,252,800	49.7	2,520,400	100.0	100.0

IMPOSTS ON MOTOR VEHICLES											
Rural areas.....	358,200	40.7	483,400	54.9	39,300	4.4			880,900	100.0	21.5
Places to 2,499.....	319,000	40.6	430,500	54.9	35,100	4.5			784,600	100.0	19.2
Places 2,500 to 14,999.....	386,700	40.6	521,900	54.8	43,400	4.6			952,000	100.0	23.2
Places 15,000 to 74,999.....	218,800	40.8	295,300	55.0	22,600	4.2			536,700	100.0	13.1
Manchester.....	207,700	40.8	280,400	55.1	20,800	4.1			508,900	100.0	12.4
Nonresident fees.....	185,500	42.5	250,500	57.5					436,000	100.0	10.6
Total.....	1,675,900	40.9	2,262,000	55.2	161,200	3.9			4,099,100	100.0	100.0

OTHER IMPOSTS											
Rural areas.....					153,400	100.0			\$153,400	100.0	35.2
Places to 2,499.....							20,100	100.0	20,100	100.0	4.6
Places 2,500 to 14,999.....							112,800	100.0	112,800	100.0	25.9
Places 15,000 to 74,999.....							81,800	100.0	81,800	100.0	18.7
Manchester.....							67,900	100.0	67,900	100.0	15.6
Total.....					153,400	35.2	282,600	64.8	436,000	100.0	100.0

ALL IMPOSTS											
Rural areas.....	368,300	16.3	716,900	31.8	1,171,100	51.9			2,256,300	100.0	32.0
Places to 2,499.....	319,000	35.5	430,800	48.0	35,100	3.9	113,100	12.6	898,000	100.0	12.7
Places 2,500 to 14,999.....	388,400	25.4	540,500	35.4	43,400	2.8	555,900	36.4	1,528,200	100.0	21.7
Places 15,000 to 74,999.....	218,800	20.5	320,300	30.0	22,600	2.1	505,000	47.4	1,066,700	100.0	15.1
Manchester.....	207,700	23.9	280,400	32.2	20,800	2.4	361,400	41.5	870,300	100.0	12.3
Nonresident fees.....	185,500	42.5	250,500	57.5					436,000	100.0	6.2
Total.....	1,687,700	23.9	2,539,400	36.0	1,293,000	18.3	1,535,400	21.8	7,055,500	100.0	100.0

OTHER FUNDS											
Federal aid.....	371,400	100.0							371,400	100.0	
Loans and reserves.....	1,402,000	82.4	183,800	10.8	116,500	6.8			1,702,300	100.0	
Grand total.....	3,461,100	37.9	2,723,200	29.8	1,409,500	15.5	1,535,400	16.8	9,129,200	100.0	

¹ Does not include costs of administering motor-vehicle taxes and principal payments on highway debts.

3. Of the total tax on rural property expended for highway purposes—

(a) 19.9 percent was expended on State and State-aid roads.

(b) 80.1 percent was expended on local rural roads.

4. Of the total tax on urban property expended for highway and street purposes—

(a) 3.5 percent was expended on State and State-aid roads.

(b) 96.5 percent was expended on urban streets.

5. Since, of the total assessed property valuation of \$623,381,700, 29.4 percent, or \$183,277,500, was in rural areas, and 70.6 percent, or \$440,104,200, was in urban areas—

(a) Expenditures from property taxes for all highways and streets were at the following rates per \$100 of assessed valuation:

Rural—66.7 cents.

Urban—29.5 cents.

(b) Expenditures from property taxes for State and State-aid roads were at the following rates per \$100 of assessed valuation:

Rural—13.3 cents.

Urban—1 cent.

(c) Expenditures from property taxes for local town roads were at the following rates per \$100 of assessed valuation:

Rural—53.4 cents.

Urban—No tax.

(d) Expenditures from property taxes for urban streets were at the following rates per \$100 of assessed valuation:

Rural—No tax.

Urban—28.5 cents.

(Continued on p. 40)

DIMENSIONS OF TESTING EQUIPMENT AFFECT HUBBARD-FIELD STABILITY VALUES

Reported by J. T. PAULS, Senior Highway Engineer, Division of Tests, Bureau of Public Roads¹

STABILITY of bituminous mixtures against shoving or rutting is recognized as an important requirement for satisfactory road behavior. Laboratory tests to determine this quality of a bituminous mixture are therefore of particular value in connection with the design and study of bituminous surfaces.

Several types of stability test are now in use, one of which is the Hubbard-Field test. This test has been used extensively in the Bureau's laboratory test work and has, in general, given very satisfactory results in testing fine-aggregate mixtures. Although the test has been adapted to the testing of coarse-aggregate mixtures by substituting larger molding and testing equipment, it has not been so used by the Bureau. This study of the effect of variation in the dimensions of molding and testing equipment is therefore concerned only with the equipment used in testing fine-aggregate mixtures. A working drawing of the equipment, showing standard dimensions, is shown in figure 1.²

In performing the Hubbard-Field stability test a prepared cylinder of the mixture 2 inches in diameter and 1 inch high is forced through a $1\frac{3}{4}$ -inch circular opening at a fixed rate of speed. The load in pounds required to do this is designated as the stability of the mixture.

In some recent cooperative work, marked discrepancies were found between the stabilities obtained on certain mixtures by the Bureau and those obtained on the same mixtures by the cooperating agency. Investigation disclosed that the equipment in use in both laboratories was worn and that the discrepancies were caused by slight differences in the dimensions of the forming and testing molds and the testing rings. Since no tolerances have ever been established for this testing equipment, it was decided to make a study of the effect of slight variations in these dimensions. For this purpose, three sets of equipment were made: One set had standard dimensions; one set was slightly undersize; and one set was slightly oversize. The sizes selected are given in table 1.

TABLE 1.—Dimensions of the three sets of equipment studied

Equipment	Internal diameter			External diameter of bottom plate of plunger
	Forming mold	Testing mold	Testing ring	
Undersize.....	Inches 1.98	Inches 2.00	Inches 1.74	Inches 1.978
Standard.....	2.00	2.02	1.75	1.998
Oversize.....	2.02	2.04	1.76	2.018

All of the forming molds now in use by the Bureau are made of a specially hardened steel and the testing mold has a hardened steel lining to reduce wear. Figure 2 shows details of this testing mold.

¹ Paper presented on Jan. 23, 1936, at the meeting of the Association of Asphalt Paving Technologists held in Cleveland, Ohio.

² See A Practical Method for Determining the Relative Stability of Fine-Aggregate Asphalt Paving Mixtures, by Prevost Hubbard and F. C. Field. Proceedings A. S. T. M., vol. 25, pt. II.

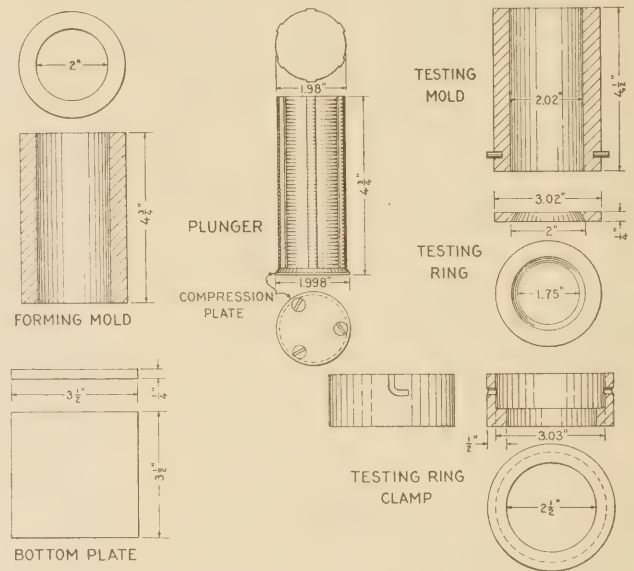

FIGURE 1.—DETAILS OF FORMING AND TESTING MOLDS, PLUNGER, TESTING RING, AND RING CLAMP.

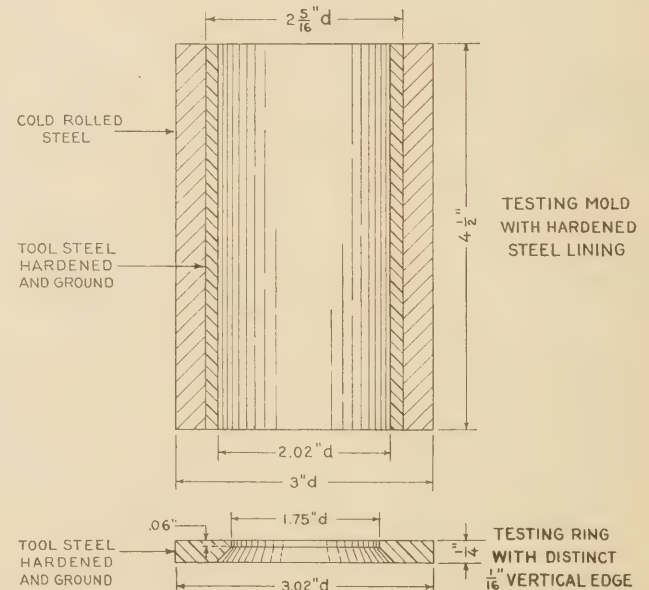

FIGURE 2.—SUGGESTED DESIGN OF TESTING MOLD AND RING TO REDUCE WEAR.

A modification in the design of the testing ring has recently been recommended by Mr. Hubbard in order to reduce wear. Rings of the new type, the details of which are shown in figure 2, were used in this study. Previous investigations by Mr. Hubbard have indicated that this change in design does not affect the test results.

The investigation was confined to a study of the effect of variations in the dimensions of the forming

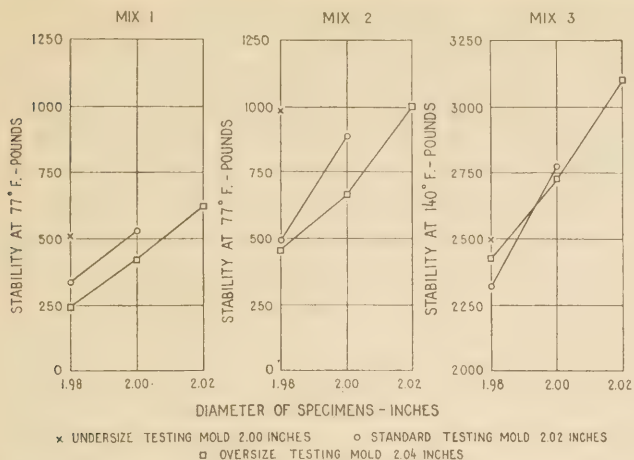

FIGURE 3.—EFFECT OF SPECIMEN DIAMETER UPON THE STABILITY OF SPECIMENS, USING STANDARD RING AND DIFFERENT SIZE TESTING MOLDS.

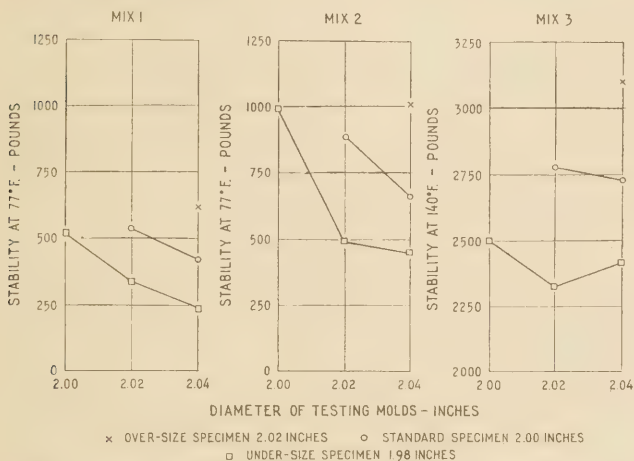

FIGURE 4.—EFFECT OF TESTING MOLD DIAMETER UPON THE STABILITY OF DIFFERENT SIZE SPECIMENS, USING STANDARD RING AND DIFFERENT SIZE CYLINDERS.

mold, the testing mold, and the testing ring. The bottom plates of the plungers were of different sizes but the study did not involve this variable. In forming the specimens the plunger used corresponded to the size of the forming mold, and in testing the specimens the plunger used corresponded to the size of the testing mold.

Stability test values were obtained on three mixtures. Mix 1 consisted of 7.4 percent slow-curing liquid asphalt, grade SC-3, and 92.6 percent Potomac River sand. Mix 2 contained 7.4 percent slow-curing liquid asphalt, grade SC-3, 14.0 percent limestone dust, and 78.6 percent Potomac River sand. Mix 3 contained 11 percent 50-60 penetration asphalt, 13 percent limestone dust, and 76 percent Potomac River sand. Each cylinder was molded under a pressure of 3,000 pounds per square inch, and the pressure was released immediately after the cylinder was formed. Mixes 1 and 2 were compressed at room temperature, and mix 3 at 300° F. Mixes 1 and 2 were tested in air at 77° F., and mix 3 in water at 140° F. after being in a water bath at 140° F. for 1 hour. All of the specimens of each mixture were made and tested in the same manner to

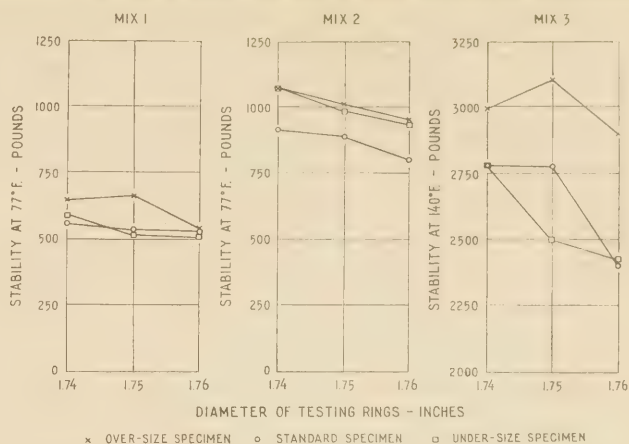

FIGURE 5.—EFFECT OF TESTING RING DIAMETER UPON THE STABILITY OF SPECIMENS TESTED IN MOLDS GIVING 0.02-INCH CLEARANCE.

TABLE 2.—Hubbard-Field stability values using different size molds and testing rings

Diameter of forming mold and specimen (inches)	Diameter of ring	Stability of mix 1, ¹ using testing molds of—			Stability of mix 2, ¹ using testing molds of—			Stability of mix 3, ² using testing molds of—		
		2.00-inch diameter	2.02-inch diameter	2.04-inch diameter	2.00-inch diameter	2.02-inch diameter	2.04-inch diameter	2.00-inch diameter	2.02-inch diameter	2.04-inch diameter
1.98	In. 1.74	Lbs. 590	Lbs. 360	Lbs. 260	Lbs. 1,070	Lbs. 550	Lbs. 480	Lbs. 2,775	Lbs. 2,275	Lbs. 2,300
	1.75	520	330	240	980	490	450	2,500	2,325	2,425
	1.76	510	320	210	930	440	420	2,425	2,100	2,275
2.00	1.74	---	570	460	---	910	740	---	2,775	2,700
	1.75	---	540	420	---	880	660	---	2,775	2,725
	1.76	---	530	370	---	800	610	---	2,400	2,675
2.02	1.74	---	---	600	---	---	1,070	---	---	3,000
	1.75	---	---	620	---	---	1,010	---	---	3,100
	1.76	---	---	540	---	---	950	---	---	2,900

¹ Tested in air at 77° F.
² Tested in water at 140° F.

insure uniformity. The results are given in table 2 and are shown graphically in figures 3, 4, and 5. All values are the averages of three tests.

Different combinations of molding and testing equipment gave stability values ranging from 210 to 620 pounds for mix 1, from 420 to 1,070 pounds for mix 2, and from 2,100 to 3,100 pounds for mix 3.

Figure 3 shows the effect upon stability of varying the diameter of the specimens using the standard ring and the 3 different sizes of testing molds. It is seen that with a particular testing mold the stability increases as the diameter of the specimen increases.

Figure 4 shows the effect upon stability of varying the diameter of the testing mold using the standard ring and the 3 different sizes of specimens. For mixes 1 and 2 the larger the testing mold for a given size of specimen the less the stability. For mix 3 (the hot sheet asphalt mixture) there is the same general trend but to a much less degree, indicating that for mixtures of this type the diameter of the specimen (as shown in figure 3) is more important than the diameter of the testing mold. The difference in behavior of mix 3 is probably caused by the greater stiffness or stability of the hot-type mixture and its greater ability to withstand deformation without rupture.

Figure 5 shows the effect of varying the size of the testing ring upon the stability of the three different sizes of specimens tested in molds having a clearance of 0.02 inch. It is seen that, generally, the larger the testing ring the less the stability value.

The results obtained in this study show that it is highly important to have and maintain standard-

dimensioned equipment. The forming and testing mold and the testing ring, which wear appreciably, should be checked frequently and replaced when there are appreciable differences from standard dimensions. It may be practical to reduce wear by providing specially hardened testing and forming molds.

(Continued from p. 37)

6. Of the total property taxes expended on all roads and streets—

(a) 11.5 percent was expended on State and State-aid roads.

(b) 38.8 percent was expended on local town roads.

(c) 49.7 percent was expended on urban streets.

7. Of the total motor-vehicle imposts expended on all classes of roads and streets—

(a) Motor-vehicle owners in rural areas paid 21.5 percent, and these same rural owners performed 23.8 percent of the total travel on all classes of roads and streets.

(b) Urban motor-vehicle owners paid 78.5 percent, and performed 76.2 percent of the total travel.

8. Of the total motor-vehicle imposts (including nonresident fees) expended on all classes of roads and streets—

(a) 96.1 percent was expended on State and State-aid roads.

(b) 3.9 percent was expended on local town roads.



HIGHWAY BRIDGES IN NEW HAMPSHIRE.

TABLE 28.—Comparison of taxation and expenditures in 1932
COMPOSITION OF EACH \$1,000 OF TAXES

Type of tax	Collected from residents of—	Amount	Per-centage of total in each group
General property taxes	Rural areas	\$158.06	26.2
	Places to 2,499	97.13	16.1
	Places 2,500 to 14,999	140.57	23.3
	Places 15,000 to 74,999	107.99	17.9
	Manchester	99.54	16.5
	Total	603.29	100.0
Motor-vehicle taxes	Rural areas	41.83	21.5
	Places to 2,499	37.74	19.4
	Places 2,500 to 14,999	45.33	23.3
	Places 15,000 to 74,999	25.68	13.2
	Manchester	25.87	13.3
	Nonresidents	18.09	9.3
	Total	194.54	100.0
Miscellaneous taxes	Rural areas	50.14	24.8
	Places to 2,499	33.56	16.6
	Places 2,500 to 14,999	52.16	25.8
	Places 15,000 to 74,999	32.95	16.3
	Manchester	33.36	16.5
	Total	202.17	100.0
	Grand total	1,000.00	

COMPOSITION OF EACH \$1,000 OF EXPENDITURES

Expended for—	Source of funds expended	Amount	Per-centage of total in each group
Highways on State system	Rural areas	\$38.39	17.6
	Urban areas	95.61	43.8
	Nonresidents	15.39	7.0
	Federal aid	13.11	6.0
	Loans and reserves	55.91	25.6
	Total	218.41	100.0
Local town roads	Rural areas	23.80	47.6
	Urban areas	22.05	44.1
	Loans and reserves	4.15	8.3
	Total	50.00	100.0
Urban streets	Urban areas	54.20	100.0
	Total all highways and streets	322.61	
Education		269.44	
Public benefit		348.68	
Government		59.27	
	Grand total	1,000.00	

9. Of all imposts and taxes (including Federal aid and loans and reserves) expended on all roads and streets—

(a) 67.7 percent was expended on State and State-aid roads.

(b) 15.5 percent was expended on local town roads.

(c) 16.8 percent was expended on urban streets.

10. Of all current imposts and taxes paid by residents, expended on all roads and streets—

(a) Rural property and motor-vehicle owners paid 34.1 percent, and travel by rural vehicles made up 23.8 percent of the total travel on all classes of roads and streets.

(b) Urban property and motor-vehicle owners paid 65.9 percent, and travel by urban vehicles made up 76.2 percent of the total travel.

STATUS OF FEDERAL AID HIGHWAY PROJECTS
(1936 FUNDS)

AS OF MARCH 31, 1936

STATE	APPORTIONMENT		COMPLETED		Miles		UNDER CONSTRUCTION		APPROVED FOR CONSTRUCTION		BALANCE OF FUNDS AVAILABLE FOR PROJECTS	
	\$	Miles	Federal Aid	Federal Total Cost	Federal Aid	Federal Total Cost	Federal Aid	Federal Total Cost	Federal Aid	Federal Total Cost		Miles
Alabama	2,604,320		\$ 263,237	\$ 1,673,657	\$ 180,341	\$ 1,673,657	26.6	74.5	\$ 1,105,519	\$ 628,637	46.0	\$ 2,604,320
Arizona	1,781,347		206,821	4,209,334	119,044	4,209,334	6.1	60.3	315,649	176,764	6.7	211,957
Arkansas	2,142,723		287,306	1,807,311	160,891	1,807,311	15.8	70.0	1,174,399	563,149	13.8	2,142,723
California	4,756,959											1,594,107
Colorado	2,288,811											945,182
Connecticut	791,253											228,104
Delaware	609,375											369,179
Florida	1,652,723											1,138,922
Georgia	3,168,221											1,963,226
Idaho	1,531,162		292,520	206,807	164,327	206,807	44.6	25.1	277,175	138,587	13.1	369,179
Illinois	5,160,696											1,138,922
Indiana	3,087,613											1,963,226
Iowa	3,231,718		244,408	1,375,596	122,499	1,375,596	6.9	121.9	2,432,660	163,410	11.8	382,362
Kansas	3,317,054											45,100
Kentucky	2,304,153		624,406	1,584,765	302,233	1,584,765	39.4	102.3	1,420,125	590,896	37.7	1,383,153
Louisiana	1,776,939											462,852
Maine	1,090,167											203,638
Maryland	1,025,870											1,025,870
Massachusetts	1,741,877											1,574,909
Michigan	3,837,292		1,028,185	3,772,712	512,695	3,772,712	33.2	139.2	2,309,750	1,154,875	92.3	286,188
Minnesota	3,423,306		334,238	2,966,580	143,116	2,966,580	12.2	180.1	2,098,312	1,020,575	210.6	1,009,950
Mississippi	2,196,524											2,196,524
Missouri	3,800,856											1,464,152
Montana	2,560,449											165,668
Nebaska	2,581,663											1,681,173
Nevada	1,595,501											541,662
New Hampshire	609,375											164,530
New Jersey	1,675,751											42,514
New Mexico	1,999,299											471,024
New York	6,150,106											1,168,034
North Carolina	2,938,657											1,827,562
North Dakota	1,960,162											1,960,162
Ohio	4,565,415											1,898,478
Oklahoma	2,947,521											1,706,870
Oregon	2,044,653											164,051
Pennsylvania	5,348,062											1,627,945
Rhode Island	609,375											609,375
South Carolina	1,692,896											1,667,503
South Dakota	2,036,775											1,444,072
Tennessee	2,638,159											1,853,393
Texas	7,777,504											2,176,393
Utah	1,410,752											171,814
Vermont	609,375											8,625
Virginia	2,278,475											1,007,861
Washington	1,949,957											390,438
West Virginia	1,356,793											860,908
Wisconsin	3,046,557											1,558,997
Wyoming	1,559,444											18,695
District of Columbia												
Hawaii	609,375											476,493
TOTALS	121,875,000		10,645,760	84,966,516	5,678,463	84,966,516	1,065.8	3,689.2	44,585,941	22,238,415	1,869.9	49,372,181

CURRENT STATUS OF UNITED STATES WORKS PROGRAM HIGHWAY PROJECTS

(AS PROVIDED BY THE EMERGENCY RELIEF APPROPRIATION ACT OF 1935)

AS OF MARCH 31, 1936

STATE	APPORTIONMENT	COMPLETED			UNDER CONSTRUCTION			APPROVED FOR CONSTRUCTION			BALANCE OF FUNDS AVAILABLE FOR PROJECTS	
		Estimated Total Cost	Works Program Funds	Miles	Estimated Total Cost	Works Program Funds	Miles	Estimated Total Cost	Works Program Funds	Miles	Total	Approved
Alabama	\$ 4,151,115	\$ 136,011	\$ 2,698,507	14.1	\$ 2,698,507	2,698,507	81.1	\$ 964,019	964,019	29.8	\$ 488,589	488,589
Arizona	2,969,841		1,631,836		1,631,836	1,631,836	82.8	637,139	637,139	46.6	543,984	543,984
Arkansas	3,352,061		1,568,730		1,568,730	1,568,730	119.3	1,174,188	1,174,188	139.4	560,778	560,778
California	7,747,928	30,260	5,205,350	10.1	5,205,350	5,010,851	182.2	479,907	468,943	25.7	2,240,074	2,240,074
Colorado	3,395,265	53,764	1,607,074	4.5	1,607,074	1,606,683	77.8	112,476	112,476	4.7	1,622,340	1,622,340
Connecticut	1,418,709							224,484	224,484	1.2	1,423,931	1,423,931
Delaware	900,310		345,599		345,599	345,599	23.5	224,484	224,484	35.2	330,227	330,227
Florida	2,597,144		1,014,196		1,014,196	996,324	38.0	1,139,823	1,139,823	35.4	460,998	460,998
Georgia	4,988,967		433,342		433,342	433,342	29.0	303,348	303,348	19.3	4,252,277	4,252,277
Idaho	2,222,747		1,042,354		1,042,354	1,039,713	87.7	372,993	358,166	26.4	824,868	824,868
Illinois	8,694,009		4,475,577		4,475,577	4,175,577	189.5	2,583,264	2,583,264	208.7	1,925,173	1,925,173
Indiana	4,941,255		2,191,828	.2	2,191,828	2,191,828	101.2	2,607,368	2,607,368	130.9	142,059	142,059
Iowa	4,991,664	15,034	1,034,315	6.6	1,034,315	986,365	73.3	1,628,129	1,547,324	224.2	2,443,865	2,443,865
Kansas	4,394,975	11,478	2,235,197	6.1	2,235,197	2,235,197	213.7	2,213,699	2,213,699	154.9	534,601	534,601
Kentucky	3,726,271		1,339,320		1,339,320	1,339,320	202.0	1,342,320	1,327,303	119.8	1,059,648	1,059,648
Louisiana	2,890,429		395,582		395,582	281,189	10.3	507,991	469,947	40.3	2,439,293	2,439,293
Maine	1,676,799		702,709		702,709	702,709	33.4	775,394	774,847	32.7	199,243	199,243
Maryland	1,750,738							509,659	454,385	22.2	1,296,353	1,296,353
Massachusetts	3,262,865							117,600	117,600	1.1	3,145,265	3,145,265
Michigan	6,301,414	449,100	5,070,971	25.4	5,070,971	5,010,941	229.9	702,600	702,600	31.0	1,387,773	1,387,773
Minnesota	5,271,145	55,973	1,229,272	37.5	1,229,272	1,195,354	83.8	2,648,258	2,648,258	620.5	1,571,743	1,571,743
Mississippi	3,457,592		1,856,276		1,856,276	1,853,183	93.9	1,068,697	1,068,697	98.6	535,672	535,672
Missouri	6,012,652	96,002	2,233,645	59.0	2,233,645	2,233,409	440.3	1,771,853	1,770,408	299.0	1,912,833	1,912,833
Montana	3,676,416		2,261,052		2,261,052	2,261,052	126.1	1,162,030	1,162,030	59.3	253,334	253,334
Nebraska	3,870,739		1,427,201		1,427,201	1,386,437	144.1	1,438,815	1,438,815	159.9	1,045,648	1,045,648
Nevada	2,243,074	62,541	1,599,234	.2	1,599,234	1,559,664	64.8	311,609	249,792	16.0	620,868	620,868
New Hampshire	945,225		233,939		233,939	231,856	7.9				463,577	463,577
New Jersey	3,129,805		1,691,035		1,691,035	1,691,035	12.9	35,084	35,084	.4	1,403,666	1,403,666
New Mexico	2,871,397		1,575,662		1,575,662	1,575,662	119.4	720,881	720,881	51.5	574,853	574,853
New York	11,046,377		4,478,662		4,478,662	4,422,658	33.4	4,480,250	4,246,340	66.2	2,377,379	2,377,379
North Carolina	4,720,173		1,928,434		1,928,434	1,916,385	165.8	1,154,815	1,154,815	53.6	1,830,832	1,830,832
North Dakota	2,867,245		332,221		332,221	322,221	48.8	552,102	552,102	85.5	1,842,772	1,842,772
Ohio	7,670,815	140,150	2,004,581	20.8	2,004,581	1,935,581	23.0	2,186,200	2,079,075	232.2	3,598,159	3,598,159
Oklahoma	4,580,670		907,736		907,736	907,736	68.9	592,727	569,629	71.0	730,046	730,046
Oregon	3,038,642		1,748,967		1,748,967	1,738,967	67.0	1,733,822	1,666,252	52.3	7,517,529	7,517,529
Pennsylvania	9,347,797		1,644,017		1,644,017	1,644,017	1.1				1,045,648	1,045,648
Rhode Island	989,208		109,796		109,796	109,796	4.0	689,152	689,152	13.4	190,261	190,261
South Carolina	2,702,012		681,043		681,043	670,920	65.3	809,174	809,174	7.8	1,222,034	1,222,034
South Dakota	2,976,484		618,289		618,289	618,289	168.7	921,657	921,657	147.8	1,256,621	1,256,621
Tennessee	11,989,350	39,435	6,934,456	15.4	6,934,456	6,307,129	391.5	1,151,228	1,151,228	42.3	2,133,032	2,133,032
Texas	2,067,154	51,885	792,615		792,615	768,254	74.0	4,135,491	4,101,506	435.6	1,541,183	1,541,183
Utah	924,306		394,961		394,961	384,733	9.9	474,090	399,763	26.5	847,252	847,252
Vermont	3,652,667		1,262,499		1,262,499	1,262,499	576.0	1,149,976	1,137,974	287.2	1,198,517	1,198,517
Virginia	3,026,161	696	2,341,943	.1	2,341,943	2,117,926	124.1	410,296	365,297	20.5	542,242	542,242
Washington	2,231,442		849,291		849,291	649,251	33.7	694,688	694,688	20.9	887,473	887,473
West Virginia	4,823,884	60,230	2,027,265	1.3	2,027,265	1,721,598	88.5	2,474,535	2,392,066	195.5	660,280	660,280
Wisconsin	2,219,155		1,635,961		1,635,961	1,635,948	93.4	263,359	263,359	31.4	319,852	319,852
Wyoming	949,496	258,054	606,950	2.1	606,950	582,920	5.5	145,000	97,862	1.9	10,660	10,660
District of Columbia	926,053		568,853		568,853	551,400	7.5	100,588	98,812	1.4	275,821	275,821
Hawaii												
TOTALS	195,000,000	1,603,972	77,957,558	283.1	77,957,558	75,907,907	5,146.3	54,579,657	52,716,044	4,531.7	64,785,905	64,785,905

CURRENT STATUS OF UNITED STATES WORKS PROGRAM GRADE CROSSING PROJECTS

(AS PROVIDED BY THE EMERGENCY RELIEF APPROPRIATION ACT OF 1935)

AS OF MARCH 31, 1936

STATE	AFFORTNMENT			COMPLETED			UNDER CONSTRUCTION			APPROVED FOR CONSTRUCTION			BALANCE OF FUNDS AVAILABLE FOR NEW PROJECTS
	Estimated Total Cost	Works Program Funded	NUMBER Eliminated by Reclamation or Other	Estimated Total Cost	Works Program Funded	NUMBER Eliminated by Reclamation or Other	Estimated Total Cost	Works Program Funded	NUMBER Eliminated by Reclamation or Other	Estimated Total Cost	Works Program Funded	NUMBER Eliminated by Reclamation or Other	
Alabama	\$ 4,074,617	\$ 47,442	1	\$ 2,167,509	\$ 2,167,509	24	\$ 1,506,287	\$ 1,506,287	11	\$ 1,506,287	\$ 1,506,287	11	\$ 360,820
Arizona	1,256,099			735,478	594,908	7	78,841	69,907	1				543,872
Arkansas	3,574,060			955,193	951,595	23	1,101,468	1,099,563	21				1,522,902
California	7,486,362			6,018,361	5,774,181	35	47,045	47,045					1,712,181
Colorado	2,631,667			1,069,497	1,048,497	18							1,576,024
Connecticut	1,712,684												1,712,684
Delaware	418,239												418,239
Florida	2,827,883			1,216,947	1,214,656	10	443,384	443,384	5				1,169,862
Georgia	4,895,949			10,581	10,581		344,859	344,859	5				4,540,510
I Idaho	1,674,479			726,573	726,573	11	125,517	125,517	1				822,388
Illinois	10,307,184			1,511,362	1,511,362	14	3,329,599	3,329,599	37				5,446,221
Indiana	5,111,096			1,689,825	1,689,825	14	1,566,800	1,566,800	7				1,854,671
Iowa	3,600,679			935,220	894,250	14	1,353,646	1,282,000	36				3,407,429
Kansas	5,246,258			2,266,950	2,266,950	21	2,251,909	2,251,909	27			1	728,299
Kentucky	3,672,387			660,096	634,783	7	2,057,499	1,532,471	14				1,505,133
Louisiana	3,213,467			198,193	197,860	4	1,351,013	1,055,202	14				2,158,265
Maine	1,426,861						408,429	408,429	9				820,573
Maryland	2,064,751						1,025,247	1,002,778	7				1,058,971
Massachusetts	4,210,833			626,871	626,871	3	329,368	329,368	7				3,254,592
Michigan	6,765,137			4,359,152	4,359,152	34	876,600	876,600	7				1,529,445
Minnesota	5,395,441			553,450	553,450	7	770,009	770,009	25			2	3,968,575
Mississippi	3,241,475			890,483	890,483	18	904,083	904,083	21				1,446,209
Missouri	6,142,153			1,189,763	1,189,763	5	3,098,234	3,084,966	19				1,867,423
Montana	2,722,327			1,949,919	1,949,919	33	656,984	656,984	4				115,424
Nebraska	3,556,441			1,052,409	1,052,409	34	1,077,347	1,077,347	30				1,426,685
Nevada	887,260			306,096	306,096	7	75,872	75,872	1				505,292
New Hampshire	824,484			140,766	140,766		81,765	81,765					539,953
New Jersey	3,983,826			353,056	353,056	5	1,057,036	1,057,036	5				2,926,790
New Mexico	1,725,286			3,687,636	3,687,636	9	201,451	189,279	14				1,046,760
New York	13,577,189			103,407	103,407	2	3,235,005	3,192,659	14				6,916,194
North Carolina	4,823,958			930,888	930,888	10	455,713	455,713	8				3,426,989
North Carolina	3,207,473			164,184	164,184	4	268,732	268,732	10				2,845,957
North Dakota	8,439,891			126,598	126,598		711,950	701,950	7				7,611,546
Ohio	5,004,311			1,057,693	1,057,693	21	705,747	700,717	11				3,246,101
Oklahoma	2,534,204			833,873	833,873	9	710,887	710,887	6				789,982
Oregon	11,483,613			323,493	307,350	6	2,083,463	2,048,373	27				9,127,890
Pennsylvania	699,691			465,562	445,236	2	229,226	211,574	2				45,122
Rhode Island	3,059,956			794,350	791,047	17	283,360	283,312	8				1,985,598
South Carolina	3,249,086			178,741	178,741	4	405,517	405,517	6				2,664,829
South Dakota	3,903,979			343,591	343,591	9	265,741	265,741	4			3	3,234,647
Tennessee	10,855,362			1,860,339	1,860,339	29	3,590,335	2,779,794	36				6,206,774
Texas	1,230,763			326,200	326,200	4	247,869	194,801	4				709,762
Utah	729,857			432,826	431,467	5	79,497	79,497	4				218,882
Vermont	3,774,287			1,722,370	1,717,570	19	1,181,965	1,107,817	33				2,442,082
Virginia	3,095,041			1,601,820	1,539,085	14	35,917	35,886	1				1,341,585
Washington	2,677,937			20,412	20,412		194,541	194,541	2				2,443,396
West Virginia	5,022,683			166,697	166,697	2	870,714	870,714	10				2,612,885
Wisconsin	1,360,841			158,695	158,695	2	225,885	225,885	2				1,099,179
Wyoming	410,804			55,365	55,365	2	253,264	253,264	1				5,491
District of Columbia	453,703			368,719	368,719	10	141,131	141,131	1				153,877
Hawaii													
TOTALS	196,000,000			47,018,811	46,196,527	518	42,286,771	40,282,676	506				109,152,078

PUBLICATIONS of the BUREAU OF PUBLIC ROADS

Any of the following publications may be purchased from the Superintendent of Documents, Government Printing Office, Washington, D. C. As his office is not connected with the Department and as the Department does not sell publications, please send no remittance to the United States Department of Agriculture.

ANNUAL REPORTS

- Report of the Chief of the Bureau of Public Roads, 1924. 5 cents.
Report of the Chief of the Bureau of Public Roads, 1927. 5 cents.
Report of the Chief of the Bureau of Public Roads, 1928. 5 cents.
Report of the Chief of the Bureau of Public Roads, 1929. 10 cents.
Report of the Chief of the Bureau of Public Roads, 1931. 10 cents.
Report of the Chief of the Bureau of Public Roads, 1933. 5 cents.
Report of the Chief of the Bureau of Public Roads, 1934. 10 cents.
Report of the Chief of the Bureau of Public Roads, 1935. 5 cents.

DEPARTMENT BULLETINS

- No. 347D . . Methods for the Determination of the Physical Properties of Road-Building Rock. 10 cents.
No. 583D . . Reports on Experimental Convict Road Camp, Fulton County, Ga. 25 cents.
No. 1279D . . Rural Highway Mileage, Income, and Expenditures, 1921 and 1922.

TECHNICAL BULLETINS

- No. 55T . . . Highway Bridge Surveys. 20 cents.
No. 265T . . . Electrical Equipment on Movable Bridges. 35 cents.

MISCELLANEOUS PUBLICATIONS

- No. 76MP . . The results of Physical Tests of Road-Building Rock. 25 cents.
Federal Legislation and Regulations Relating to Highway Construction. 10 cents.

Supplement No. 1 to Federal Legislation and Regulations Relating to Highway Construction.

No. 191 . . . Roadside Improvement. 10 cents.

The Taxation of Motor Vehicles in 1932. 35 cents.

An Economic and Statistical Analysis of Highway-Construction Expenditures. 15 cents.

Single copies of the following publications may be obtained from the Bureau of Public Roads upon request. They cannot be purchased from the Superintendent of Documents.

MISCELLANEOUS CIRCULARS

No. 62MC . . Standards Governing Plans, Specifications, Contract Forms, and Estimates for Federal-Aid Highway Projects.

SEPARATE REPRINT FROM THE YEARBOOK

No. 1036Y . . Road Work on Farm Outlets Needs Skill and Right Equipment.

TRANSPORTATION SURVEY REPORTS

- Report of a Survey of Transportation on the State Highway System of Ohio (1927).
Report of a Survey of Transportation on the State Highways of Vermont (1927).
Report of a Survey of Transportation on the State Highways of New Hampshire (1927).
Report of a Plan of Highway Improvement in the Regional Area of Cleveland, Ohio (1928).
Report of a Survey of Transportation on the State Highways of Pennsylvania (1928).
Report of a Survey of Traffic on the Federal-Aid Highway Systems of Eleven Western States (1930).
-

A complete list of the publications of the Bureau of Public Roads, classified according to subject and including the more important articles in PUBLIC ROADS, may be obtained upon request addressed to the U. S. Bureau of Public Roads, Willard Building, Washington, D. C.

CURRENT STATUS OF UNITED STATES PUBLIC WORKS ROAD CONSTRUCTION

AS PROVIDED BY SECTION 204 OF THE NATIONAL INDUSTRIAL RECOVERY ACT (1934 FUNDS) AND BY THE ACT OF JUNE 18, 1934 (1935 FUNDS)

AS OF MARCH 31, 1936

STATE	APPORTIONMENTS			COMPLETED				UNDER CONSTRUCTION				APPROVED FOR CONSTRUCTION			BALANCE OF FUNDS AVAILABLE FOR NEW PROJECTS	
	Sec. 204 of the Act of June 16, 1933 (1934 Fund)	Act of June 18, 1934 (1935 Fund)	Total Cost	1934 Public Works Funds	1935 Public Works Funds	Mileage	Estimated Total Cost	1934 Public Works Funds	1935 Public Works Funds	Mileage	1934 Public Works Funds	1935 Public Works Funds	Mileage	1934 Public Works Funds	1935 Public Works Funds	
Alabama.....	\$ 6,370,133	\$ 4,259,842	\$ 14,152,602	\$ 2,146,647	\$ 2,683,285	720.3	\$ 1,194,759	\$ 186,798	\$ 1,002,762	44.2	\$ 309,254	\$ 36,468	3.4	\$ 36,468	\$ 264,541	
Arizona.....	5,211,960	2,641,975	8,662,522	5,203,929	2,383,026	940.6	268,654	183,967	183,967	5.3	26,345	8,031	0.3	8,031	48,597	
Arkansas.....	6,748,335	3,428,049	10,208,185	6,561,060	2,681,466	571.4	625,747	63,188	941,902	35.2	148,283	104,377	13.0	104,377	56,798	
California.....	15,607,324	7,932,206	28,050,215	15,601,612	6,512,172	751.2	2,405,566	1,272,495	1,272,495	21.4	115,553	5,522	0.9	5,522	31,986	
Colorado.....	6,874,530	1,426,086	14,101,269	1,101,269	3,144,821	69.3	441,623	396,102	396,102	3.8	30,000	45,099	0.0	45,099	33,421	
Connecticut.....	2,865,740	1,494,868	4,183,531	2,855,079	982,214	69.3	441,623	396,102	396,102	3.8	30,000	40,661	0.0	40,661	84,551	
Delaware.....	1,819,088	923,395	2,646,496	1,819,088	782,660	128.3	32,528	32,528	32,528	1.6	108,207	43,435	1.6	43,435	91,702	
Florida.....	5,231,834	2,841,343	8,241,565	5,185,433	1,851,433	281.6	1,026,026	1,026,026	1,026,026	25.6	160,538	160,538	3.1	160,538	284,528	
Georgia.....	10,091,185	5,113,491	11,764,660	9,085,816	2,233,108	673.9	1,593,050	498,333	1,086,693	73.3	257,556	632,856	56.4	283,481	1,160,804	
Idaho.....	4,486,249	2,271,486	6,291,959	4,402,467	1,479,676	489.0	674,429	1,788,987	673,241	9.7	59,759	61,215	2.9	61,215	111,891	
Illinois.....	17,570,770	8,324,401	21,960,235	15,686,095	5,287,899	606.3	4,897,431	3,638	3,638	88.5	338,573	111,891	2.2	111,891	284,938	
Indiana.....	10,037,895	5,086,965	12,853,678	9,456,658	2,860,958	390.4	2,417,003	388,159	1,974,222	95.4	66,419	126,367	2.2	126,367	61,270	
Iowa.....	10,095,604	5,118,361	15,218,322	9,939,405	4,694,613	1,214.2	2,807,803	114,454	162,100	4.9	296,800	2,101	5.0	2,101	44,848	
Kansas.....	10,089,604	5,117,675	14,214,457	9,961,286	3,868,871	1,088.9	2,807,803	39,153	1,223,762	43.3	73,575	15,589	2.2	15,589	17,547	
Kentucky.....	7,517,559	3,818,311	10,660,629	6,976,085	2,918,908	760.5	1,149,356	463,762	604,212	45.3	29,243	48,269	6.3	48,269	54,899	
Louisiana.....	5,828,591	2,963,932	7,844,567	5,147,837	2,075,443	214.4	1,174,471	608,584	566,287	35.6	10,666	61,504	4.4	61,504	183,827	
Maine.....	3,569,917	1,711,586	4,304,578	3,340,131	1,370,913	184.8	283,470	283,470	283,470	8.3	261,564	57,218	8.3	57,218	249,529	
Maryland.....	5,564,527	1,810,058	4,322,625	2,792,426	598,990	113.3	1,163,202	706,936	460,122	31.3	4,060	113,198	1.8	113,198	309,269	
Massachusetts.....	6,597,100	3,350,474	7,007,620	4,637,052	1,831,767	104.3	3,071,060	1,896,850	1,179,718	11.0	4,437	29,576	1.8	29,576	38,631	
Michigan.....	12,736,227	6,462,568	18,272,668	12,543,316	4,526,914	676.3	2,018,971	1,531,406	1,791,718	92.4	30,825	29,576	1.0	29,576	17,547	
Minnesota.....	10,656,569	5,426,551	15,590,184	9,876,724	4,764,364	1,622.6	8,845,761	646,206	1,881,445	25.9	4,060	182,579	1.8	182,579	269,593	
Mississippi.....	6,918,675	3,340,227	10,482,165	6,080,931	1,693,357	609.0	2,560,938	771,411	1,595,941	127.9	4,437	184,058	11.8	184,058	66,872	
Missouri.....	15,180,306	6,173,740	15,076,574	10,891,759	3,240,954	1,360.5	4,414,720	1,185,562	2,440,249	90.8	114	102,986	4.9	102,986	29,505	
Montana.....	7,459,734	3,169,734	11,022,861	7,179,659	3,190,727	1,006.2	6,14,655	159,632	455,023	24.8	145,025	100,467	1.2	100,467	121,984	
Nebraska.....	4,626,961	3,364,364	12,369,405	7,730,625	3,377,897	992.0	732,366	65,281	467,313	42.0	120,283	8,870	9.2	33,096	6,870	
Nevada.....	1,999,859	2,969,462	4,969,316	1,999,443	1,960,871	736.0	352,393	26,150	290,647	21.7	29,461	35,368	0.0	35,368	31,720	
New Hampshire.....	6,346,039	3,420,879	6,832,962	6,001,676	473,165	74.9	2,751,538	175,941	2,258,664	12.4	303,276	168,421	6.6	168,421	185,774	
New Jersey.....	5,792,935	2,941,700	8,498,814	5,632,432	2,660,013	766.5	1,511,694	475,941	1,511,694	1.1	114	160,389	0.9	160,389	91,624	
New Mexico.....	22,330,101	11,327,921	37,178,864	21,577,255	9,123,381	799.8	3,165,750	553,400	2,063,799	25.2	145,025	70,200	1.2	70,200	70,540	
North Carolina.....	9,522,293	4,890,941	14,237,986	9,048,263	3,973,687	1,320.8	716,643	122,138	579,610	20.3	35,078	316,615	4.3	316,615	79,000	
North Dakota.....	5,604,448	2,938,967	7,274,966	5,484,057	1,140,659	1,949.5	788,804	131,259	598,949	112.4	67,289	121,865	76.5	121,865	614,221	
Ohio.....	15,484,592	7,865,012	22,940,793	15,264,953	5,580,210	748.8	2,280,266	198,571	2,016,366	43.4	11,000	102,989	3.5	102,989	169,526	
Oklahoma.....	9,216,798	4,686,180	13,285,023	9,060,692	3,246,249	774.0	1,194,282	447,071	1,046,476	30.6	53,642	163,826	1.9	163,826	240,629	
Oregon.....	6,106,836	3,097,814	9,482,463	5,956,045	2,653,769	461.8	3,233,223	30,834	264,244	3.6	66,377	90,725	3.3	90,725	4,051	
Pennsylvania.....	18,891,004	9,990,788	27,264,862	17,886,622	8,122,157	981.5	1,597,954	736,539	179,268	76.8	5,126	262,716	2.1	262,716	385,692	
Rhode Island.....	1,986,708	1,014,572	2,982,260	1,993,708	850,540	88.0	138,587	32,110	131,102	1.1	1,220	175,126	0.6	175,126	26,090	
South Carolina.....	5,459,165	2,770,934	7,100,723	5,246,723	1,687,463	578.5	701,531	110,396	627,862	39.6	69,251	423,529	27.9	423,529	103,299	
South Dakota.....	6,011,479	3,047,643	8,496,141	5,763,253	2,178,615	1,471.1	484,072	15,396	468,676	52.8	291,093	163,579	27.9	163,579	103,299	
Tennessee.....	8,482,619	4,202,921	12,053,977	8,279,024	3,136,485	1,722.5	1,024,045	212,000	715,905	11.6	23,000	139,310	9.0	139,310	179,310	
Texas.....	20,204,634	12,202,921	35,153,356	20,153,356	7,114,801	2,609.0	3,114,801	196,031	3,000,000	83.0	50,431	61,024	15.1	61,024	112,003	
Utah.....	4,194,708	2,132,691	6,960,949	4,156,256	1,861,919	584.6	327,504	6,060	261,191	6.9	1,500	32,291	0.0	32,291	2,081	
Vermont.....	1,867,573	948,007	3,054,441	1,863,531	847,927	137.6	109,059	3,922	90,873	2.4	4,750	121	1.21	121	4,456	
Virginia.....	7,416,757	3,765,387	11,222,211	7,174,592	3,135,607	573.0	484,072	112,885	362,960	44.2	55,648	73,633	2.9	73,633	238,588	
Washington.....	6,115,867	3,106,412	8,824,867	6,098,634	2,504,487	292.7	574,946	112,885	566,849	10.1	1,727	17,333	0.0	17,333	31,390	
West Virginia.....	4,474,294	2,280,335	5,502,877	4,314,485	988,343	186.6	1,051,184	115,848	881,403	31.9	293,744	116,845	4.2	116,845	116,845	
Wisconsin.....	9,724,861	4,941,837	14,783,615	9,677,528	4,294,058	604.6	572,508	7,300	565,208	15.3	91,594	61,452	0.0	61,452	61,452	
Wyoming.....	4,501,527	2,287,712	6,661,596	4,453,871	2,051,719	1,008.5	236,140	46,705	182,532	28.8	35,589	20,745	0.0	20,745	35,607	
District of Columbia.....	1,918,469	973,842	2,670,032	1,909,584	660,313	19.5	313,125	351,635	277,625	2.9	8,740	35,904	0.0	35,904	35,904	
Hawaii.....	1,871,062	949,778	1,885,014	1,510,686	40.0	40.0	1,465,742	351,635	914,171	15.6	1,009,655	8,740	0.0	8,740	35,607	
TOTALS.....	394,000,000	200,000,000	569,158,958	375,945,871	144,471,853	33,259.6	59,593,111	13,478,341	41,606,348	1,678.7	1,009,655	6,633,084	290.9	3,566,133	7,304,715	

