

DEPARTMENT OF TRANSPORTATION**National Highway Traffic Safety Administration****49 CFR Parts 531, 533, 536, and 537**

[NHTSA–2021–0053]

RIN 2127–AM34

Corporate Average Fuel Economy Standards for Model Years 2024–2026 Passenger Cars and Light Trucks**AGENCY:** National Highway Traffic Safety Administration (NHTSA).**ACTION:** Final rule.

SUMMARY: NHTSA, on behalf of the Department of Transportation, is finalizing revised fuel economy standards for passenger cars and light trucks for model years (MYs) 2024–2025 that increase at a rate of 8 percent per year, and increase at a rate of 10 percent per year for MY 2026 vehicles. NHTSA currently projects that the revised standards would require an industry fleet-wide average of roughly 49 mpg in MY 2026, and would reduce average fuel outlays over the lifetimes of

affected vehicles that provide consumers hundreds of dollars in net savings. These standards are directly responsive to the agency's statutory mandate to improve energy conservation and reduce the Nation's energy dependence on foreign sources. This final rule fulfills NHTSA's obligation to revisit the standards set forth in "The Safer Affordable Fuel Efficient (SAFE) Vehicles Rule for Model Years 2021–2026 Passenger Cars and Light Trucks," as directed by President Biden's January 20, 2021, Executive order "Protecting Public Health and the Environment and Restoring Science To Tackle the Climate Crisis." The revised standards set forth in this final rule are consistent with the policy direction in the order, to among other things, listen to the science, improve public health and protect our environment, and to prioritize both environmental justice and the creation of the well paying union jobs necessary to deliver on these goals. This final rule addresses public comments to the notice of proposed rulemaking and also makes certain minor changes to fuel economy reporting requirements.

DATES: This rule is effective July 1, 2022.**ADDRESSES:** For access to the dockets or to read background documents or comments received, please visit <https://www.regulations.gov>, and/or Docket Management Facility, M–30, U.S. Department of Transportation, West Building, Ground Floor, Room W12–140, 1200 New Jersey Avenue SE, Washington, DC 20590. The Docket Management Facility is open between 9 a.m. and 4 p.m. Eastern Time, Monday through Friday, except Federal holidays.**FOR FURTHER INFORMATION CONTACT:** For technical and policy issues, Greg Powell, CAFE Program Division Chief, Office of Rulemaking, National Highway Traffic Safety Administration, 1200 New Jersey Avenue SE, Washington, DC 20590; email: gregory.powell@dot.gov. For legal issues, Rebecca Schade, NHTSA Office of Chief Counsel, National Highway Traffic Safety Administration, 1200 New Jersey Avenue SE, Washington, DC 20590; email: rebecca.schade@dot.gov.**SUPPLEMENTARY INFORMATION:**

BILLING CODE 4910–59–P

Table of Acronyms and Abbreviations

Abbreviation	Term
4WD	Four-wheel drive
AAA	American Automobile Association
AALA	American Automotive Labeling Act
AC	Air conditioning
ACC	American Chemistry Council
ACEEE	American Council for an Energy Efficient Economy
ACS	American Cancer Society
ADAS	Advanced driver assistance systems
ADEAC	Advanced cylinder deactivation
ADSL	Baseline diesel engine technology
ADVENG	Non-basic engine technologies
AEC	Applied Economics Clinic
AECD	Auxiliary Emission Control Devices
AEJ	American Economic Journal
AEO	Annual Energy Outlook
AER	All-electric range
AERO	Aerodynamic improvements
AERO0	Baseline Aerodynamic Drag Technology
AERO10	Aerodynamic Drag, 10% Drag Coefficient Reduction
AERO15	Aerodynamic Drag, 15% Drag Coefficient Reduction
AERO20	Aerodynamic Drag, 20% Drag Coefficient Reduction
AERO5	Aerodynamic Drag, 5% Drag Coefficient Reduction
AFPM	American Fuel & Petrochemical Manufacturers
AFV	Alternative fuel vehicle
AGM	Absorbed-glass-mat
AIM	American Innovation and Manufacturing
AIS	Abbreviated Injury Scale
AKI	Anti-Knock Index
AMFA	Alternative Motor Fuels Act of 1988
AMTL	Advanced Mobility Technology Laboratory
ANL	Argonne National Laboratory

ANL/ESD	Argonne National Laboratory/Energy Systems Division
ANSI	American National Standards Institute
APA	Administrative Procedure Act
AQMD	Air Quality Management District
ASTM	ASTM International
AT10L2	10-speed automatic transmission, Level 2
AT10L3	10-speed automatic transmission, Level 3
AT4	4-speed automatic transmission
AT5	5-speed automatic transmission
AT6	6-speed automatic transmission
AT6L2	6-speed automatic transmission, Level 2
AT7L2	7-speed automatic transmission, Level 2
AT8	8-speed automatic transmission
AT8L2	8-speed automatic transmission, Level 2
AT8L3	8-speed automatic transmission, Level 3
AT9L2	9-speed automatic transmission, Level 2
ATK	Atkinson cycle engine
AVE	Alliance for Vehicle Efficiency
AWD	All-wheel drive
BEA	Bureau of Economic Analysis
BEV	Battery electric vehicle
BEV200	200-Mile Battery Electric Vehicle
BEV300	300-Mile Battery Electric Vehicle
BEV400	400-Mile Battery Electric Vehicle
BEV500	500-Mile Battery Electric Vehicle
BGEPA	Bald and Golden Eagle Protection Act
BISG	Belt integrated starter/generator
BMEP	Brake mean effective pressure
BMW	BMW of North America, LLC
BNEF	Bloomberg New Energy Finance
BPT	Benefit-Per-Ton
BSD	Blind Spot Detection
BSFC	Brake-specific fuel consumption
BTE	Brake Thermal Efficiency
BXR	BXR Motors
CAA	Clean Air Act
CAD	Computer Aided Design
CAFE	Corporate average fuel economy
CARB	California Air Resources Board
CAS	Center for Auto Safety
CASAC	Clean Air Science Advisory Committee
CAV	Connected and automated vehicle
CBD	Center for Biological Diversity
CBI	Confidential business information
cEGR	Cooled exhaust gas recirculation
CEGR1	Turbocharged Engine with Cooled Exhaust Gas Recirculation

CEI	Competitive Enterprise Institute
CEQ	Council on Environmental Quality
CFA	Consumer Federation of America
CH ₄	Methane
CI	Confidence Interval
CIB	Crash Imminent Braking
CISG	Crank Integrated Starter Generator
CMB	Combined
CNG	Compressed natural gas
CO ₂	Carbon dioxide
CONFIG	Engine cam configuration
CONV	Conversion
COVID-19	Coronavirus disease of 2019
CR	Compression ratio
CSAPR	Cross-State Air Pollution Rule
CUV	Crossover utility vehicle
CVT	Continuously variable transmissions
CVTL2	Continuous variable transmission level 2HEG
CY	Calendar year
CZMA	Coastal Zone Management Act
DBS	Dynamic Brake Support
DCT	Dual clutch transmissions
DD	Direct drive
DEAC	Cylinder deactivation
DFS	Dynamic fleet share
DMC	Direct manufacturing cost
DOE	Department of Energy
DOHC	Dual over-head camshaft
DOI	Department of the Interior
DOT	Department of Transportation
DPM	Diesel particulate matter
DR	Discount Rate
DSLI	Advanced diesel engine with improvements
DSLIA	Advanced diesel engine
DSLIAAD	Advanced diesel engine with improvements and advanced cylinder deactivation
EC/OC	Elemental carbon and organic carbon
ECA	U.S. Emission Control Areas
ECCE	Energy Conversion Congress and Exposition
eCVT	Electronic continuously variable transmission
EDF	Environmental Defense Fund
EETT	Electrical and Electronics Technical Team
EFR	Engine friction reduction
EGR	Exhaust gas recirculation
EHPS	Electro-hydraulic power steering
EIA	U.S. Energy Information Administration

EIS	Environmental Impact Statement
EISA	Energy Independence and Security Act
ELEC	Electrification and hybridization
ELECACC	Electric accessory improvement technologies
ELPC	Environmental Law & Policy Center
E.O.	Executive Order
EPA	U.S. Environmental Protection Agency
EPCA	Energy Policy and Conservation Act
EPS	Electric power steering
EREV	Extended range electric vehicle
ERF	Engine friction reduction
ESA	Endangered Species Act
ESG	Environmental, social, and governance
ETDS	Electric Traction Drive System
ETW	Equivalent test weight
EU	European Union
EV	Electric Vehicle
FARS	Fatal Accident Reporting System
FCA	Fiat Chrysler Automobiles
FCEV	Fuel cell electric vehicle
FCIV	Fuel consumption improvement value
FCV	Fuel cell vehicle
FCW	Forward Collision Warning
FE	Fuel economy
FEV	FEV Group GmbH
FFV	Flexible-fuel vehicles
FHWA	Federal Highway Administration
Final SEIS	Final Supplemental Environmental Impact Statement
FMVSS	Federal Motor Vehicle Safety Standards
FMY	Final-model year
FRIA	Final Regulatory Impact Analysis
FTP	Federal Test Procedure
FWCA	Fish and Wildlife Conservation Act
FWD	Front-Wheel Drive
FWS	U.S. Fish and Wildlife Service
GCAMReference	Global Change Assessment Model Reference
GCVW	Gross combined weight
GCWR	Gross combined weight rating
GDP	Gross domestic product
GES	General Estimates System
GGE	Gasoline gallon equivalents
GHG	Greenhouse gas
GM	General Motors
GMC	General Motor Company
GREET	Greenhouse gases, Regulated Emissions, and Energy use in Transportation

GSA	General sales and administrative costs
GVW	Gross vehicle weight
GVWR	Gross vehicle weight rating
GWh	Gigawatt hours
GWP	Global warming potential
HCR	High compression ratio
HCR0	High Compression Ratio Engine (Atkinson Cycle)
HCR1	Advanced High Compression Ratio Engine (Atkinson Cycle)
HCR1D	Advanced High Compression Ratio Engine (Atkinson Cycle) with Cylinder Deactivation
HCR2	High Compression Ratio Engine (Atkinson Cycle) with Cylinder Deactivation
HEG	High efficiency gearbox
HEV	Hybrid electric vehicle
HFET	Highway Fuel Economy Test
HP	Horsepower
HT	Heavy-duty truck
HVAC	Heating, ventilation, and air conditioning
HWFET	Highway Fuel Economy Test
IACC	Improved accessories
IACMI	Institute for Advanced Composites Manufacturing Innovation
IAM	Integrated Assessment Model
IAV	Automotive Engineering, Inc.
IC	Internal combustion
ICCT	International Council on Clean Transportation
ICE	Internal combustion engine
ICEV	Internal combustion engine vehicle
ICM	Indirect Cost Multiplier
ICR	Information collection request
iEGR	Internal exhaust gas recirculation
IPCC	Intergovernmental Panel on Climate Change
IPI	Institute for Policy Integrity at New York School of Law
IQR	Inner quartile range
ISA	Ozone Integrated Science Assessment
ISG	Integrated starter/generator
ITB	ITB Group, Ltd.
IWG	Interagency Working Group
JLR	Jaguar Land Rover NA, LLC
KABCO	Scale used to represent injury severity in crash reporting
LDB	Low drag brakes
LDV	Light duty passenger vehicle
LDW	Lane Departure Warning
LE	Learning effects
LEV	Low-emission vehicle
LIB	Lithium-ion batteries
LIVC	Late Intake Valve Closing
LKA	Lane Keep Assist

LT	Light truck
LTV	Light Trucks and Vans
MAIS	Maximum abbreviated injury scale
MARC	Mid-Atlantic Regional Council
MBTA	Migratory Bird Treaty Act
MDPCS	Minimum domestic passenger car standard
MECA	Manufacturers of Emission Controls Association
MEMA	Motor & Equipment Manufacturers Association
MIT	Massachusetts Institute of Technology
MMBD	Million Barrels Per Day
MMBtu	Metric Million British Thermal Unit
mmt	Million Metric Tons for Carbon Dioxide Equivalent
MMTCO ₂	Million metric tons of carbon dioxide
MMY	Mid-model year
MOU	Memorandum of Understanding
MOVES	Motor Vehicle Emission Simulator
MPG	Miles per gallon
MPGe	Miles per gallon of gasoline-equivalent
MPV	Multi-purpose vehicle
MR	Mass reduction
MR0	Baseline Mass Reduction Technology
MR1	Mass Reduction – 5.0% of Glider
MR2	Mass Reduction – 7.5% of Glider
MR3	Mass Reduction – 10.0% of Glider
MR4	Mass Reduction – 15.0% of Glider
MR5	Mass Reduction – 20.0% of Glider
MR6	Mass Reduction – 28.2% of Glider
MSRP	Manufacturer suggested retail price
MT	Manual transmission
MY	Model year
N ₂ O	Nitrous oxide
NA	Naturally aspirated
NAAQS	National Ambient Air Quality Standards
NADA	National Automotive Dealers Association
NAICS	North American Industry Classification System
NAP	National Academies Press
NAS	National Academy of Sciences
NASEM	National Academies of Science, Engineering, and Medicine
NATSO	National Association of Truck Stop Operators
NBER	National Bureau of Economic Research
NCAP	New Car Assessment Program
NCAT	National Coalition for Advanced Transportation
NDA	Non-disclosure agreement
NEDC	New European Driving Cycle
NEMS	National Energy Modeling System
NEPA	National Environmental Policy Act

NESCCAF	Northeast States Center for a Clean Air Future
NGO	Non-governmental organization
NHPA	National Historic Preservation Act
NHTSA	National Highway Traffic Safety Administration
NIPA	National Income and Product Accounts
NMC	Nickel manganese cobalt
NMOG	Nonmethane organic gas
NO _x	Nitrogen oxide
NPRM	Notice of proposed rulemaking
NRC	National Research Council
NRDC	Natural Resources Defense Council
NREL	National Renewable Energy Laboratory
NTTAA	National Technology Transfer and Advancement Act
NVH	Noise-vibration-harshness
NVO	Negative valve overlap
NVPP	National Vehicle Population Profile
OAQPS	Office of Air Quality Planning and Standards
OEM	Original equipment manufacturer
OHV	Over-head valve
OMB	Office of Management and Budget
OPEC	Organization of the Petroleum Exporting Countries
ORNL	Oak Ridge National Laboratories
P2HCR0	Strong Hybrid Electric Vehicle, Parallel with HCR0 Engine
P2HCR1	Strong Hybrid Electric Vehicle, Parallel with HCR1 Engine
P2HCR1D	Strong Hybrid Electric Vehicle, Parallel with HCR1D Engine
P2HCR2	Strong Hybrid Electric Vehicle, Parallel with HCR2 Engine
PAEB	Pedestrian Automatic Emergency Braking
PAG	Polyalkylene Glycol
PAN	Polyacrylonitrile
PC	Passenger car
PDO	Property damage-only
PEF	Petroleum Equivalency Factor
PFI	Port Fuel Injection
PHEV	Plug-in hybrid electric vehicle
PHEV20	20-mile plug-in hybrid electric vehicle
PHEV20T	20-mile plug-in hybrid electric vehicle with TURBO1 Engine
PHEV50	50-mile plug-in hybrid electric vehicle
PHEV50H	50-mile plug-in hybrid electric vehicle with Atkinson Engine
PHEV50T	50-mile plug-in hybrid electric vehicle with TURBO1 Engine
PIC	Public Information Center
PM _{2.5}	Particulate matter with a diameter equal to or less than 2.5 microns
PMY	Pre-model year
PRA	Paperwork Reduction Act of 1995
PRIA	Preliminary Regulatory Impact Analysis
RC	Reference case
RFS	Renewable Fuels Standard

RIA	Regulatory Impact Analysis
RIN	Regulation identifier number
ROD	Record of Decision
ROLL	Tire rolling resistance
ROLL0	Baseline Tire Rolling Resistance
ROLL10	Tire Rolling Resistance, 10% Improvement
ROLL20	Tire Rolling Resistance, 20% Improvement
ROLL30	Tire Rolling Resistance, 30% Improvement
RPE	Retail price equivalent
RRC	Rolling resistance coefficient
RWD	Rear-wheel drive
SAE	Society of Automotive Engineers
SAFE	Safer Affordable Fuel-Efficient
SAX	Secondary axle disconnect
SBREFA	Small Business Regulatory Enforcement Fairness Act
SC-GHG	Social cost of greenhouse gases
SCC	Social cost of carbon
SEC	Securities and Exchange Commission
SEIS	Supplemental Environmental Impact Statement
SELC	Southern Environmental Law Center
SGDI	Stoichiometric gasoline direct injection
SHEV	Strong hybrid vehicle
SHEVP2	Parallel strong hybrid electric vehicle
SHEVPS	Power split strong hybrid electric vehicle
SIP	State Implementation Plan
SO ₂	Sulfur dioxide
SOHC	Single over-head camshaft
SO _x	Sulfur oxide
SPR	Strategic petroleum reserve
SS12V	12-volt stop-start
SUV	Sport utility vehicle
TAR	Technical Assessment Report
TARGETFE	Fuel economy target
TBS	Total Battery Consulting
TG-PAN	Textile-grade polyacrylonitrile
TRANS	Transmission technologies
TSD	Technical Support Document
TTI	Texas Transportation Institute
TURBO	Turbocharged
TURBO1	Turbocharged Engine
TURBO2	Advanced Turbocharged Engine
TURBOAD	Turbocharged engine with advanced cylinder deactivation
TURBOD	Turbocharged engine with cylinder deactivation
TWh	Terawatts
TZEV	Transitional zero-emissions vehicles

U.S.	United States
U.S.C.	United States Code
UAW	International Union, United Automobile, Aerospace & Agricultural Implement Workers of America
UCS	Union of Concerned Scientists
UMRA	Unfunded Mandates Reform Act of 1995
UNCTAD	United Nations Conference on Trade and Development
UNFCCC	United Nations Framework Convention on Climate Change
USABC	United States Advanced Battery Consortium
USITC	United States International Trade Commission
USTMA	U.S. Tire Manufacturers Association
VBA	Visual Basic for Applications
VCR	Variable compression ratio
VGT	Variable geometry turbochargers
VMT	Vehicle-miles traveled
VOC	Volatile organic compounds
VSL	Value of a statistical life
VSS	Vehicle Safety Standards
VTG	Turbo geometry technology
VTGE	Variable turbo geometry electric
VVL	Variable valve lift
VVT	Variable valve timing
VW	Volkswagen
VWA	Volkswagen Group of America
WDNR	Wisconsin Department of Natural Resources
WLTP	Worldwide Harmonized Light Duty Vehicles Test Procedure
ZETA	Zero Emission Transportation Association
ZEV	Zero Emission Vehicle

Does this action apply to me?

This action affects companies that manufacture or sell new passenger

automobiles (passenger cars) and non-passenger automobiles (light trucks) as defined under NHTSA’s CAFE

regulations.¹ Regulated categories and entities include:

Category	NAICS Codes ^A	Examples of Potentially Regulated Entities
Industry.....	335111 336112	Motor Vehicle Manufacturers.
Industry.....	811111 811112 811198 423110	Commercial Importers of Vehicles and Vehicle Components.
Industry.....	335312 336312 336399 811198	Alternative Fuel Vehicle Converters.

^A North American Industry Classification System (NAICS).

BILLING CODE 4910-59-C

This list is not intended to be exhaustive, but rather provides a guide regarding entities likely to be regulated by this action. To determine whether particular activities may be regulated by this action, you should carefully examine the regulations. You may direct questions regarding the applicability of this action to the persons listed in **FOR FURTHER INFORMATION CONTACT**.

Executive Summary

NHTSA, on behalf of the Department of Transportation, is amending standards regulating corporate average fuel economy (CAFE) for passenger cars and light trucks for MYs 2024–2026. This final rule responds to NHTSA’s statutory obligation to set CAFE standards at the maximum feasible level that the agency determines vehicle manufacturers can achieve in each model year, in order to improve energy conservation. NHTSA’s review of the prior standards was instigated in response to President Biden’s directive in Executive Order 13990 of January 20, 2021, “Protecting Public Health and the Environment and Restoring Science To Tackle the Climate Crisis,” that “The

Safer Affordable Fuel-Efficient (SAFE) Vehicles Rule for Model Years 2021–2026 Passenger Cars and Light Trucks” (2020 final rule, SAFE rule, or SAFE 2 final rule) (85 FR 24174, April 30, 2020) be immediately reviewed for consistency with NHTSA’s statutory obligation and our Nation’s abiding commitment to promote and protect our public health and the environment, among other things. NHTSA undertook that review immediately, and this final rule is the result of that review, conducted with reference to NHTSA’s statutory obligations.

The amended CAFE standards increase in stringency for both passenger cars and light trucks, by 8 percent per year for MYs 2024–2025, and by 10 percent per year for MY 2026. The agency calls the amended standards Alternative 2.5. NHTSA concludes that these levels are the maximum feasible for these model years as discussed in more detail in Section VI. The final rule considers a range of regulatory alternatives, consistent with NHTSA’s obligations under the National Environmental Policy Act (NEPA) and E.O. 12866. While E.O. 13990 directed the review of CAFE standards for MYs

2021–2026, statutory lead time requirements² mean that MY 2024 is the earliest model year that can currently be amended in the CAFE program.³ The standards remain vehicle-footprint-based, like the CAFE standards in effect since MY 2011. Recognizing that many readers think about CAFE standards in terms of the miles per gallon (mpg) values that the standards are projected to eventually require, NHTSA currently projects that the standards will require, on an average industry fleet-wide basis, roughly 49 mpg in MY 2026. NHTSA notes both that real-world fuel economy is generally 20–30 percent lower than the estimated required CAFE level stated above, and also that the actual CAFE standards are the footprint target curves for passenger cars and light trucks, meaning that ultimate fleet-wide levels will vary depending on the mix of vehicles that industry produces for sale in those model years. Table I–1 shows the incremental differences in stringency levels for passenger cars and light trucks, by the different regulatory alternatives considered, in the model years subject to regulation.

¹ “Passenger car” and “light truck” are defined in 49 CFR part 523.

² 49 U.S.C. 32902(a) and (g).

³ 49 U.S.C. 32902(a).

Table I-1 – Final Incremental Stringency Levels (mpg above Baseline) for Passenger Cars and Light Trucks, by Regulatory Alternative

Model Year	Alternative 0 (Baseline/No-Action Alternative)	Alternative 1	Alternative 2	Alternative 2.5 (Preferred Alternative)	Alternative 3
Passenger cars					
2024	-	3.9	3.3	3.3	4.3
2025	-	4.9	6.8	6.8	9.2
2026	-	5.9	10.8	12.1	14.7
Light trucks					
2024	-	3.5	2.2	2.2	3.0
2025	-	4.2	4.7	4.7	6.4
2026	-	5.1	7.6	8.5	10.4
Total					
2024	-	3.7	2.6	2.5	3.5
2025	-	4.5	5.5	5.5	7.5
2026	-	5.3	8.7	9.7	11.9

This final rule reflects a conclusion significantly different from the conclusion that NHTSA reached in the 2020 final rule, but this is because important facts have changed, and because NHTSA has reconsidered how to balance the relevant statutory considerations in light of those facts. In this document, NHTSA concludes that significantly more stringent standards are the maximum feasible that the agency determines that vehicle manufacturers can achieve in the rulemaking time frame. Standards that are more stringent than those that were finalized in 2020 appear economically practicable, based on manageable average per-vehicle cost increases, large consumer fuel savings, minimal effects on sales, and estimated increases in employment, among other things. Additionally, and importantly, contrary to the 2020 final rule, NHTSA recognizes that the need of the United States to conserve energy must include serious consideration of the energy security risks, as well as environmental and public health implications, of continuing to consume oil, which more stringent fuel economy standards can reduce. By increasing fuel economy, more stringent standards can also protect consumers from oil market volatility from global events outside the borders of the U.S. that can result in rapid fuel price increases domestically. Through greater energy conservation, more stringent standards also reduce climate impacts to our Nation, which further benefit our national security. NHTSA also believes that the final standards are complementary to other

motor vehicle standards of the Government that are simultaneously applicable during MYs 2024–2026.

Moreover, at least part of the automobile industry is increasingly demonstrating that improving fuel economy and reducing GHG emissions is a growth market for them, and that the market rewards investment in advanced technology. Nearly all auto manufacturers have rolled out new higher fuel economy and electric vehicle models since MY 2020, and continue to announce even more models forthcoming during the rulemaking time frame. Five major manufacturers voluntarily bound themselves to stricter GHG requirements than set forth by the U.S. Environmental Protection Agency (EPA) in 2020 through contractual agreements with the State of California.⁴ Some of the technologies that automakers will deploy to meet those standards will both reduce emissions and improve fuel economy. These companies (including both those who joined the Framework Agreements with California and those that have not) are sophisticated, for-profit enterprises. If they are taking these steps, rolling out these new models, and making these announcements, NHTSA can now be more confident than the agency was in 2020 that the market is getting ready to make the leap to significantly higher fuel economy. The California Framework Agreements and the clear planning by industry to migrate toward more advanced technologies provide

⁴ <https://ww2.arb.ca.gov/news/framework-agreements-clean-cars> (accessed: March 23, 2022).

corroborating evidence of the practicability of more stringent standards. Additionally, more stringent CAFE standards can improve equity, by encouraging industry to continue improving the fuel economy of all vehicles, so that all Americans can benefit from higher fuel economy and save money on fuel. While NHTSA does not consider the fuel economy of electric vehicles in setting CAFE standards, consistent with Congress' direction in 49 U.S.C. 32902(h), using electric vehicles to meet the standards is a compliance option that many automakers are pursuing. Further, NHTSA is setting these CAFE standards in the context of a much larger conversation about the future of the U.S. light-duty vehicle fleet, the increasing and obvious need to move away from fossil fuels for reasons of national and energy security, and the evidence of a changing climate that is emerging on an almost daily basis.

NHTSA concludes, as we will explain in more detail below, that Alternative 2.5 is the maximum feasible alternative that manufacturers can achieve for MYs 2024–2026, based on its significant fuel savings benefits to consumers and its environmental and energy security benefits relative to all other alternatives except Alternative 3. Although Alternative 3 would provide greater fuel savings benefits, NHTSA estimates that Alternative 3 would result in a large average per-vehicle cost increase compared to the price of vehicles under Alternative 2.5, which for many automakers could exceed \$2,000. In contrast to Alternative 3, Alternative 2.5

comes at a cost we believe the market can bear, and NHTSA believes it is the appropriate choice given this record. We believe that providing the greatest amount of lead time for the biggest stringency increase of 10 percent for MY 2026, the last of three years covered in the rule, is reasonable and appropriate, particularly given the ongoing rapid changes in the auto industry. Choosing Alternative 3 would require industry to ramp up even faster, and thus provide less lead time, with consequences for economic practicability. With relatively small sales effects and positive effects on employment, we are confident that Alternative 2.5 is feasible, and that industry can rise to meet these standards.

For all of these reasons, and based on consideration of the comments received, NHTSA concludes that Alternative 2.5, with standards that increase at 8 percent per year for MYs 2024 and 2025, and a 10-percent increase in MY 2026, is maximum feasible.

This action is also different from the 2020 final rule in that it is issued by NHTSA alone, and EPA has issued a separate final rule.⁵ EPA's revised standards apply to MY 2023 as well as MYs 2024–2026. NHTSA's 18-month lead time requirement precludes amendment of the MY 2023 CAFE standards. An important consequence of this is that EPA's rate of stringency increase, after increasing in MY 2023, looks slower than NHTSA's over the same time period, although collectively

EPA's standards achieve at least as stringent levels as NHTSA's Alternative 2.5 by MY 2026.⁶ NHTSA emphasizes, however, that the new standards are what NHTSA believes best fulfill our statutory directive of energy conservation. Additionally, in the context of the EPA standards, the analysis we have done tackles the core question of whether compliance with both standards should be achievable with the same vehicle fleet, after manufacturers fully understand the requirements from both sets of standards, and NHTSA believes that, as always, compliance with both standards will be achievable with the same vehicle fleet. It is also worth noting that the differences in what the two agencies' standards require become smaller each year, until near alignment is achieved in 2026.

While NHTSA recognizes that the last three CAFE standard rulemakings have been issued jointly with EPA, and that issuing separate rules represents a change in regulatory approach, NHTSA coordinated with EPA to avoid inconsistencies and produce requirements that are consistent with the agencies' respective statutory authorities.⁷ Additionally, and

⁶ EPA projected a fleet average fuel economy value of about 52 mpg associated with its MY 2026 standards (assuming full use of air conditioning refrigerant credits). See Table 4–43, “Revised 2023 and Later Model Year Light-Duty Vehicle GHG Emissions Standards: Regulatory Impact Analysis,” EPA–420–R–21–028, December 2021.

⁷ Throughout this preamble, NHTSA uses the term “maximum feasible” as shorthand to refer to

importantly, NHTSA has also considered and accounted for California's Zero Emission Vehicle (ZEV) program (and its adoption by a number of other states) in developing the baseline for this final rule, and has also accounted in the baseline for the aforementioned “Framework Agreements” between California and BMW, Ford, Honda, VWA, and Volvo, which are national-level GHG emission reduction agreements to which these companies committed for several model years. NHTSA reasonably assumes that automakers will meet other regulatory requirements that apply to them, and commitments that they have made through the Framework Agreements. Reflecting these in the analysis improves the accuracy of the baseline in reflecting the state of the world without the revised CAFE standards, and thus the information available to the decision-makers.

A number of other improvements and updates have been made to the analysis since the 2020 final rule based on NHTSA analysis, new data, and public comments to the NPRM (86 FR 49602, Sept. 3, 2021) as described in Section III. Table I–2 summarizes these, and they are discussed in much more detail below and in the documents accompanying this preamble.

the statutory directive in EPCA, requiring the agency to exercise its discretionary authority to set CAFE standards at the “maximum feasible average fuel economy level that the Secretary decides the manufacturers can achieve in that model year.” 49 U.S.C. 32902(a).

⁵ 86 FR 74434 (Dec. 30, 2021).

Table I-2 – Key Analytical Updates from 2020 Final Rule

Key Updates
In all regulatory alternatives, account for the Zero Emission Vehicle (ZEV) mandates applicable in California and the states that have adopted them.
In all regulatory alternatives, account for some vehicle manufacturers' (BMW, Ford, Honda, VWA, and Volvo) voluntary commitments to the state of California to continued annual nationwide reductions of vehicle greenhouse gas emissions through model year (MY) 2026, with greater rates of electrification than would have been required under the 2020 final rule.
In all regulatory alternatives, account for manufacturers' responses to both CAFE (alternatives) and baseline carbon dioxide standards jointly (rather than only separately).
Establish procedures to ensure that modeled technology application and production volumes are the same across all regulatory alternatives in the earliest model years.
Include procedures to focus application of the EPCA's "standard setting constraints" (i.e., regarding the consideration of compliance credits and additional dedicated alternative fueled vehicles) more precisely to only those model years for which NHTSA is proposing or finalizing new standards.
Include more accurate accounting for compliance treatment of flexible-fuel vehicles (FFVs) and plug-in hybrid electric vehicles (PHEVs).
Include CAFE civil penalties in the "effective cost" metric used when simulating manufacturers' potential application of fuel-saving technologies.
Make COVID-19 pandemic adjustment to vehicle miles traveled (VMT) model inputs (per Federal Highway Administration estimate of 2020 national VMT).
Embed Federal Highway Administration's VMT model in CAFE Model (dynamic model).
Report criteria pollutant health effects separately for refining and electricity generation.
New procedures to estimate the impacts and corresponding monetized damages of highway vehicle crashes that do not result in fatalities, now based on historical data and future trend models that reflect the impacts of advanced crash-avoidance technologies.
Update social cost of carbon and damage costs for methane and nitrous oxide (interim guidance February 19, 2021).
Incorporate fuel and electricity prices using Energy Information Administration's Annual Energy Outlook 2021.
Update Analysis fleet to MY 2020.
Update large-scale simulation using Argonne National Laboratory's Autonomie model.
Include 400- and 500-mile battery electric vehicles (BEVs).
Update battery and battery management unit size and costs using BatPaC version 4.0 (October 2020).
Update hybrid electric vehicles, PHEV, and BEV electric machine and battery sizing.
Include high compression ratio (HCR) engines with cylinder deactivation.
Expand turbo downsizing to include reducing low-powered 4-cylinder naturally aspirated engines to 3-cylinder turbocharged engines.
Update 10-speed automatic transmission efficiency characteristics based on benchmarking data from Southwest Research Institute.
Update cold start offset assumptions using MY 2020 compliance data.
Update mass regression analysis values for engines and electric motors.
Use more accurate accounting for off-cycle incremental costs relative to MY 2020 baseline fleet.
Reduce price elasticity from -1.0 to -0.4
Reduce rebound to 10% from 15%
Revise off-cycle credit cap to 10 g/mi for MYs 2020-2022
Adjustments to Consumer Welfare, Financing, and Insurance costs
Update fuel cell vehicle technology inputs.
Reduce battery cost for 12-volt start-stop systems
Reduce high voltage cabling cost for power-split and P2 hybrid systems
Reduce eCVT transmission cost

NHTSA estimates that this action could reduce average fuel outlays over the lifetimes of MY 2029 vehicles by about \$1,387, while increasing the average cost of those vehicles by about \$1,087 over the baseline described above, at a 3-percent discount rate. With the social cost of greenhouse gases (SC-GHG)⁸ and all other benefits and costs discounted at 3 percent, when considering the entire fleet for MYs 1981–2029, NHTSA estimates \$128 billion in monetized costs and \$145 billion in monetized benefits attributable to the new standards, such that the present value of aggregate net monetized benefits to society would be over \$16 billion, not including other important unquantified effects, such as energy security benefits, distributional effects, and certain air quality benefits from the reduction of toxic air pollutants and other emissions, among other things.

These cost and benefit estimates are based on many different and uncertain inputs. One of the inputs informing the benefits estimates is the SC-GHG. In this final rule, NHTSA employed the SC-GHG values from the Interim Revised Estimates developed by the Interagency Working Group on the Social Cost of Greenhouse Gases (IWG), and discounted it at values recommended by the IWG for its main analysis. Those values are based on the best available science and economics and are the most appropriate values to focus on in the analysis of this rule, though DOT also affirms that, in its expert judgment, those values are conservative estimates that likely significantly underestimate the full benefits to social welfare of reducing greenhouse gas pollution. NHTSA also explored in its sensitivity analyses values based on other assumptions, including values calculated at different discount rates. Furthermore, in light of pending litigation, NHTSA also explored an analysis that used the same SC-GHG value employed in the 2020 final rule. Specifically, on February 11, 2022, the United States District Court for the Western District of Louisiana issued a preliminary injunction that enjoined NHTSA from, among other activities, “[a]dopting, employing, treating as binding, or relying upon any Social Cost of Greenhouse Gas estimates based on global effects,” as well as from

“adopting, employing, treating as binding, or relying upon the work product of the [IWG].”⁹

Although the injunction was stayed by the United States Court of Appeals for the Fifth Circuit on March 16, 2022,¹⁰ prior to the stay, in order to comply with this prohibition, NHTSA conducted a cost-benefit analysis based on the SC-GHG values presented in the 2020 final rule. In DOT’s judgment, those values do not reflect the best available science and economics for estimating climate effects in the analysis of this rule. As detailed more thoroughly elsewhere in this rule and the supporting Technical Support Document (TSD) and Final Regulatory Impact Analysis (FRIA), the only way to achieve an efficient allocation of resources for greenhouse gas emissions reduction on a global basis—and so benefit the United States and its citizens—is for all countries to consider global estimates of climate damages. To correctly assess the total climate damages to U.S. citizens and residents, an analysis must account for all climate impacts that directly and indirectly affect the welfare of U.S. citizens and residents, how U.S. greenhouse gas mitigation activities affect mitigation activities by other countries, and spillover effects from climate action elsewhere. The estimates used in the 2020 rule, therefore, severely underestimate climate damages. Nevertheless, even if NHTSA’s cost-benefit analysis applied the misleadingly low SC-GHG estimates from the 2020 rule, which severely underestimate the impacts of climate effects on U.S. citizens, NHTSA would still conclude in this rule that Alternative 2.5 is maximum feasible under its statutory authority. Notably, for example, net consumer benefits from significant fuel savings remained positive for Alternative 2.5 independent of any estimate of climate benefits.

Moreover, NHTSA is required to consider four statutory factors—technological feasibility, economic practicability, the effect of other motor vehicle standards of the Government on fuel economy, and the need of the United States to conserve energy—to determine whether the standards it adopts are maximum feasible,¹¹ and NHTSA finds that Alternative 2.5 is the maximum feasible on the basis of these factors, and particularly considering the statutory mandate to improve energy

conservation and reduce the Nation’s energy dependence on foreign sources. The cost-benefit analysis is not one of those statutory factors. While NHTSA’s estimates of costs and benefits are important considerations and are directed by E.O. 12866, again, it is the balancing required by statute—that is, the requirement to set CAFE standards at “the maximum feasible average fuel economy level that the Secretary decides the manufacturers can achieve in that model year” 49 U.S.C. 32902(a)—that is the basis for the setting of CAFE standards. Cost-benefit analysis provides only one informative data point in addition to the host of considerations that NHTSA must balance by statute when determining maximum feasible standards. As such, any changes in the monetized climate benefit figures that resulted from using the SC-GHG value from the 2020 final rule did not justify disrupting the overall balance of other significant qualitative and quantitative considerations and factors that support the selection of the Preferred Alternative—as described at length throughout this final rule. When the 5th Circuit stayed the injunction, NHTSA returned to using the Interim SC-GHG developed by the IWG, discounted at 3 percent, because we believe it to be the more accurate and reasonable value.

It is worth emphasizing that CAFE standards apply only to new vehicles. The costs attributable to new CAFE standards are thus “front-loaded,” because they result primarily from the application of fuel-saving technology to new vehicles. By contrast, the impact of new CAFE standards on fuel consumption and energy savings, air pollution, and greenhouse gases—and the associated benefits to society—occur over an extended time, as drivers buy, use, and eventually scrap these new vehicles. By accounting for many model years and extending well into the future (2050), our analysis accounts for these differing patterns in impacts, benefits, and costs. Given the front-loaded costs versus longer-term benefits, it is likely that an analysis extending even further into the future would reveal at least some additional net present benefits. Our analysis also accounts for the potential that, by changing new vehicle prices and fuel economy levels, CAFE standards could indirectly impact the operation of vehicles produced before or after the MYs 2024–2026 for which we are finalizing new CAFE standards. This means that some of the final rule’s impacts and corresponding benefits and costs are actually attributable to indirect

⁸ The “social cost of greenhouse gases” or “SC-GHG” refers to the combination of the social costs of carbon dioxide (CO₂), methane (CH₄), and nitrous oxide (N₂O) emissions. In this preamble, and in the TSD, FRIA, and Final SEIS, NHTSA may occasionally use the term “social cost of carbon” or “SCC” to refer to the SC-GHG, and means no substantive difference between them.

⁹ *Louisiana v. Biden*, Order, No. 2:21–CV–01074, ECF No. 99 (W.D. La. Feb. 11, 2022).

¹⁰ *Louisiana v. Biden*, Order, No. 22–30087, Doc. No. 00516242341 (5th Cir. Mar. 16, 2022).

¹¹ 49 U.S.C. 32902(g).

impacts on vehicles produced before and after MYs 2024–2026.

The bulk of our analysis considers a “model year” perspective that considers the lifetime impacts attributable to all vehicles produced prior to MY 2030, accounting for the operation of these vehicles over their entire lives (with some MY 2029 vehicles estimated to be in service as late as 2068). This approach emphasizes the role of MYs 2024–2026, while accounting for the potential that it may take manufacturers a few additional years to produce fleets fully responsive to the final MY 2026 standards,¹² and for the potential that the final standards could induce some

¹²The fact that manufacturers have up to three model years to “settle” compliance for a given model year is a function of statutory flexibilities—namely, that overcompliance credits may be “carried back” up to three model years—and does not in any way imply that NHTSA believes that the MY 2026 standards are not feasible in MY 2026.

changes in the operation of vehicles produced prior to MY 2024, for example, some individuals might choose to keep older vehicles in operation, rather than purchase new ones.

Our analysis also considers a “calendar year” (CY) perspective that includes the annual impacts attributable to all vehicles estimated to be in service in each calendar year for which our analysis includes a representation of the entire registered light-duty fleet. For this final rule, this calendar year perspective covers each of CYs 2021–2050, with differential impacts accruing as early as MY 2023.¹³ Compared to the “model year” perspective, this calendar year perspective emphasizes model years of vehicles produced in the longer term,

¹³For a presentation of effects by calendar year, please see FRIA Chapter 6.5 and Chapter 6.6.

beyond those model years for which standards are currently being promulgated. Table I–3 summarizes estimates of selected impacts viewed from each of these two perspectives, for each of the regulatory alternatives considered in this final rule.¹⁴

BILLING CODE 4910–59–P

¹⁴As discussed at length below, Alternative 0 is the set of CAFE standards promulgated in 2020, and thus constitutes the “No-Action Alternative.” Impacts of the four “Action Alternatives” are measured relative to this baseline. Alternatives 1, 2, 2.5, and 3 specify passenger car and light truck standards for each of MYs 2024–2026 that NHTSA estimates will, taken together, increase overall CAFE requirements in MY 2026 by about 14, 22, 25, and 30 percent, respectively, although actual average requirements will ultimately depend on the future composition of the fleet, which NHTSA cannot predict with certainty. Above, Table I–1 shows corresponding projected increases in average requirements for each fleet in each model year. Below, Section IV.B discusses the specific definitions of each of these regulatory alternatives.

Table I-3 – Selected Cumulative Impacts - Model and Calendar Year Perspectives, Average SC-GHG¹⁵

	Alt. 1	Alt. 2	Alt. 2.5	Alt. 3
Avoided Gasoline Consumption (b. gal)				
MYs 1981-2029	30	54	60	77
CYs 2021-2050	100	201	234	299
Additional Electricity Consumption (GWh)				
MYs 1981-2029	53	150	179	249
CYs 2021-2050	226	736	938	1,291
Reduced CO ₂ Emissions (mmt)				
MYs 1981-2029	318	542	607	767
CYs 2021-2050	1,029	1,985	2,281	2,874
Monetized Benefits (\$b, 3% Discount Rate)				
MYs 1981-2029	79	129	145	182
CYs 2021-2050	233	422	478	596
Monetized Costs (\$b, 3% Discount Rate)				
MYs 1981-2029	59	114	128	166
CYs 2021-2050	165	324	367	467
Monetized Net Benefits (\$b, 3% Discount Rate)				
MYs 1981-2029	21	15	16	16
CYs 2021-2050	67	98	112	129
Monetized Benefits (\$b, 7% Discount Rate)				
MYs 1981-2029	54	89	100	126
CYs 2021-2050	141	257	292	365
Monetized Costs (\$b, 7% Discount Rate)				
MYs 1981-2029	43	85	96	124
CYs 2021-2050	97	193	219	280
Monetized Net Benefits (\$b, 7% Discount Rate)				
MYs 1981-2029	11	4	4	2
CYs 2021-2050	44	64	73	85

Additional important health, environmental, and energy security benefits could not be fully quantified or monetized. Finally, for purposes of

comparing the benefits and costs of new CAFE standards to the benefits and costs of other Federal regulations, policies, and programs, we have

computed “annualized” benefits and costs.

Table I-4 – Estimated Monetized Costs, Benefits, and Net Benefits Across MYs 1981-2029 (billions of dollars), Total Fleet for Alternative 1, Average SC-GHG¹⁶

	Totals		Annualized	
	3% Discount Rate	7% Discount Rate	3% Discount Rate	7% Discount Rate
Costs	58.6	43.0	2.30	3.12
Benefits	79.2	54.5	3.11	3.96
Net Benefits	20.6	11.5	0.81	0.83

¹⁵ Climate benefits are based on reductions in CO₂, CH₄, and N₂O emissions and are calculated using four different estimates of the global social cost of each greenhouse gas (SC-GHG model average at 2.5 percent, 3 percent, and 5 percent discount rates; 95th percentile at 3 percent discount rate), which each increase over time. For the presentational purposes of this table and other similar summary tables, we show the benefits associated with the average global SC-GHG at a 3

percent discount rate, but the agency does not have a single central SC-GHG point estimate. We emphasize the importance and value of considering the benefits calculated using all four SC-GHG estimates. See Section III.G.2 for more information. Where percent discount rate values are reported in this table, the social benefits of avoided climate damages are discounted at 3 percent. The climate benefits are discounted at the same discount rate as

used in the underlying SC-GHG values for internal consistency.

¹⁶ To be clear, monetized values do not include other important unquantified effects, such as certain climate benefits, certain energy security benefits, distributional effects, and certain air quality benefits from the reduction of toxic air pollutants and other emissions, among other things.

Table I-5 – Estimated Costs, Benefits, and Net Benefits Across MYs 1981-2029 (billions of dollars), Total Fleet for Alternative 2, Average SC-GHG

	Totals		Annualized	
	3% Discount Rate	7% Discount Rate	3% Discount Rate	7% Discount Rate
Costs	113.9	84.9	4.47	6.17
Benefits	129.4	89.3	5.07	6.48
Net Benefits	15.5	4.3	0.61	0.32

Table I-6 – Estimated Costs, Benefits, and Net Benefits Across MYs 1981-2029 (billions of dollars), Total Fleet for Alternative 2.5, Average SC-GHG

	Totals		Annualized	
	3% Discount Rate	7% Discount Rate	3% Discount Rate	7% Discount Rate
Costs	128.4	95.8	5.03	6.96
Benefits	144.6	99.7	5.67	7.25
Net Benefits	16.3	3.9	0.64	0.29

Table I-7 – Estimated Costs, Benefits, and Net Benefits Across MYs 1981-2029 (billions of dollars), Total Fleet for Alternative 3, Average SC-GHG

	Totals		Annualized	
	3% Discount Rate	7% Discount Rate	3% Discount Rate	7% Discount Rate
Costs	165.8	124.3	6.50	9.03
Benefits	182.2	125.8	7.14	9.14
Net Benefits	16.4	1.5	0.64	0.11

Table I-8 – Estimated Costs, Benefits, and Net Benefits Across CYs 2021-2050 (billions of dollars), Total Fleet for Alternative 1, Average SC-GHG

	Totals		Annualized	
	3% Discount Rate	7% Discount Rate	3% Discount Rate	7% Discount Rate
Costs	165.3	96.9	8.43	7.81
Benefits	232.7	141.4	11.87	11.39
Net Benefits	67.4	44.5	3.44	3.59

Table I-9 – Estimated Costs, Benefits, and Net Benefits Across CYs 2021-2050 (billions of dollars), Total Fleet for Alternative 2, Average SC-GHG

	Totals		Annualized	
	3% Discount Rate	7% Discount Rate	3% Discount Rate	7% Discount Rate
Costs	324.0	192.9	16.53	15.54
Benefits	422.0	257.1	21.53	20.72
Net Benefits	98.0	64.2	5.00	5.18

Table I-10 – Estimated Costs, Benefits, and Net Benefits Across CYs 2021-2050 (billions of dollars), Total Fleet for Alternative 2.5, Average SC-GHG

	Totals		Annualized	
	3% Discount Rate	7% Discount Rate	3% Discount Rate	7% Discount Rate
Costs	366.8	218.7	18.71	17.63
Benefits	478.5	292.1	24.41	23.54
Net Benefits	111.7	73.3	5.70	5.91

Table I-11 – Estimated Costs, Benefits, and Net Benefits Across CYs 2021-2050 (billions of dollars), Total Fleet for Alternative 3, Average SC-GHG

	Totals		Annualized	
	3% Discount Rate	7% Discount Rate	3% Discount Rate	7% Discount Rate
Costs	466.7	279.8	23.81	22.55
Benefits	595.9	364.9	30.40	29.40
Net Benefits	129.3	85.1	6.60	6.86

Again, and as discussed in detail below, the monetized estimated costs and benefits of this final rule are relevant to and inform the agency’s conclusion regarding which levels of CAFE standards are maximum feasible for MYs 2024–2026, but they do not fully capture the total benefits of the standards and are not part of the factors contained in the governing statute. It is the balancing of the four statutory factors (none of which expressly requires maximization of net benefits,

although NHTSA does consider net benefits pursuant to E.O. 12866) that provides the basis for setting CAFE standards. Notably, NHTSA confirms that on the basis of its four statutory factors, and particularly considering the statutory mandate to improve energy conservation and reduce the Nation’s energy dependence on foreign sources, NHTSA would select Alternative 2.5 as the maximum feasible even if the cost-benefit analysis had adopted different

assumptions for the monetization of climate benefits.

It is also worth emphasizing that, although NHTSA is prohibited from considering the availability of certain flexibilities in making our determination about the levels of CAFE standards that would be maximum feasible,¹⁷ manufacturers have a variety of flexibilities available to them to aid their compliance. Table I–12 through Table I–15 below summarize available compliance flexibilities.

Table I-12 – Statutory Flexibilities for Over-compliance with Standards

Regulatory Item	NHTSA	
	Authority	Current Program
Credit Earning	49 U.S.C. 32903(a)	Denominated in tenths of a mpg
Credit “Carry-forward”	49 U.S.C. 32903(a)(2)	5 model years into the future
Credit “Carryback” (AKA “deficit carry-forward”)*	49 U.S.C. 32903(a)(1)	3 model years into the past
Credit Transfer	49 U.S.C. 32903(g)	Up to 2 mpg per fleet; transferred credits may not be used to meet minimum domestic passenger car standard (MDPCS)
Credit Trade*	49 U.S.C. 32903(f)	Unlimited quantity; traded credits may not be used to meet MDPCS

*NHTSA did not expressly model credit carryback, and credit trades were only modeled for credits that existed at the beginning of the modeling simulation. All other credits in this table were modeled.

¹⁷ 49 U.S.C. 32902(h).

Table I-13 – Current and Proposed Flexibilities that Address Gaps in Compliance Test Procedures

Regulatory Item	NHTSA	
	Authority	Current and New Program
Air conditioning efficiency	49 U.S.C. 32904	Allows manufacturers to earn “fuel consumption improvement values” (FCIVs) equivalent to EPA credits starting in MY 2017
Off-cycle	49 U.S.C. 32904	Allows manufacturers to earn FCIVs equivalent to EPA credits starting in MY 2017 <i>For MY 2020 and beyond, NHTSA is implementing CAFE provisions equivalent to the EPA proposed changes</i>

Table I-14 – Incentives that Encourage Application of Technologies

Regulatory Item	NHTSA	
	Authority	Proposed and New Program
Full-size pickup trucks with HEV or overperforming target*	49 U.S.C. 32904	Allows manufacturers to earn FCIVs equivalent to EPA credits for MYs 2017-2021 <i>NHTSA is reinstating incentives for strong hybrid OR overperforming target by 20% for MYs 2022-2025</i>

*These credits were not modeled for the NPRM analysis.

Table I-15 – Incentives that Encourage Alternative Fuel Vehicles

Regulatory Item	NHTSA	
	Authority	Current Program
Dedicated alternative fuel vehicle	49 U.S.C. 32905(a) and (c)	Fuel economy calculated assuming gallon of liquid or gallon equivalent gaseous alt fuel = 0.15 gallons of gasoline; for EVs petroleum equivalency factor
Dual-fueled vehicles	49 U.S.C. 32905(b), (d), and (e); 49 U.S.C. 32906(a)	Fuel economy calculated using 50% operation on alt fuel and 50% on gasoline through MY 2019. Starting with MY 2020, NHTSA uses the SAE defined “Utility Factor” methodology to account for actual potential use, and “F-factor” for FFV; NHTSA will continue to incorporate the 0.15 incentive factor

BILLING CODE 4910-59-C

NHTSA recognizes that the lead time for this final rule is shorter than some past rulemakings have provided, and that the economy and the country are in the process of recovering from a global pandemic and the resulting economic distress. At the same time, NHTSA also recognizes that at least parts of the industry are nonetheless stepping up their product offerings and releasing more and more high-fuel-economy vehicle models, and many companies did not deviate significantly over the past ten years from product plans established in response to the EPA and NHTSA standards set forth in the 2012 final rule (77 FR 62624, Oct. 15, 2012) and the EPA standards confirmed by EPA in its January 2017 Final Determination. With these and other

considerations in mind, NHTSA is amending the CAFE standards for MYs 2024–2026, and believes that Alternative 2.5 is maximum feasible and represents the best balancing of multiple statutory and policy goals for these model years. NHTSA, like any other Federal agency, is afforded an opportunity to reconsider prior views and, when warranted, to adopt new positions. Indeed, as a matter of good governance, agencies should revisit their positions when appropriate, especially to ensure that their actions and regulations reflect legally sound interpretations of the agency’s statutory authority and remain consistent with the agency’s policy views and practices. As a matter of law, “an Agency is entitled to change its interpretation of a

statute.”¹⁸ Nonetheless, “[w]hen an Agency adopts a materially changed interpretation of a statute, it must in addition provide a ‘reasoned analysis’ supporting its decision to revise its interpretation.”¹⁹ The analysis presented in this preamble and in the accompanying TSD, FRIA, Final Supplemental Environmental Impact Statement (Final SEIS), CAFE Model Documentation, and extensive

¹⁸ *Phoenix Hydro Corp. v. FERC*, 775 F.2d 1187, 1191 (D.C. Cir. 1985).

¹⁹ *Alabama Educ. Ass’n v. Chao*, 455 F.3d 386, 392 (D.C. Cir. 2006) (quoting *Motor Vehicle Mfrs. Ass’n of U.S., Inc. v. State Farm Mut. Auto. Ins. Co.*, 463 U.S. 29, 57 (1983)); see also *Encino Motorcars, LLC v. Navarro*, 136 S. Ct. 2117, 2125 (2016) (“Agencies are free to change their existing policies as long as they provide a reasoned explanation for the change.”) (citations omitted).

rulemaking docket fully supports the agency's decision and revised balancing of the statutory factors for MYs 2024–2026 standards.

II. Overview of the Final Rule

In this final rule, NHTSA is revising CAFE standards for MYs 2024–2026. On January 20, 2021, the President signed E.O. 13990, “Protecting Public Health and the Environment and Restoring Science To Tackle the Climate Crisis.”²⁰ In it, the President directed that the 2020 final rule must be immediately reviewed for consistency with the policy commitments in that E.O., including listening to the science; improving public health and protect our environment; ensuring access to clean air and water; limiting exposure to dangerous chemicals and pesticides; holding polluters accountable, including those who disproportionately harm communities of color and low-income communities; reducing greenhouse gas emissions; bolstering resilience to the impacts of climate change; restoring and expanding our national treasures and monuments; and prioritizing both environmental justice and the creation of the well-paying union jobs necessary to deliver on these goals.²¹ E.O. 13990 states expressly that the Administration prioritizes listening to the science, improving public health and protecting the environment, reducing greenhouse gas emissions, and improving environmental justice while creating well-paying union jobs.²² The E.O. thus directs that the 2020 final rule be reviewed at once and that (in this case) the Secretary of Transportation consider “suspending, revising, or rescinding” it, via an NPRM, by July 2021.²³ On September 3, 2021, NHTSA published an NPRM to revise these requirements, which are being finalized, with changes in response to public comments and additional analysis, in this final rule.

Section 32902(g)(1) of title 49, United States Code allows the Secretary (by delegation to NHTSA) to prescribe regulations amending an average fuel economy standard prescribed under 49 U.S.C. 32902(a), like those prescribed in the 2020 final rule, if the amended standard meets the requirements of section 32902(a). The Secretary's authority to set fuel economy standards is delegated to NHTSA at 49 CFR 1.95(a); therefore, NHTSA is revising fuel economy standards for MYs 2024–2026. Section 32902(g)(2) states that

when the amendment makes an average fuel economy standard more stringent, it must be prescribed at least 18 months before the beginning of the model year to which the amendment applies. NHTSA generally calculates the 18-month lead time requirement as April of the calendar year prior to the start of the model year. Thus, 18 months before MY 2023 would be April 2021, because MY 2023 begins in October 2022. Because of this lead time requirement, NHTSA is not amending the CAFE standards for MYs 2021–2023, even though the 2020 final rule also covered those model years. For purposes of the CAFE program, the 2020 final rule's standards for MYs 2021–2023 will remain in effect.

For the model years for which there is statutory lead time to amend the standards, however, NHTSA is amending the currently applicable fuel economy standards. Although only two years have passed since the 2020 final rule, the agency believes it is reasonable and appropriate to revisit the CAFE standards for MYs 2024–2026. In particular, the agency has further considered the serious adverse effects on energy conservation that the standards finalized in 2020 would cause as compared to the final standards. The need of the U.S. to conserve energy is greater than understood in the 2020 final rule. In addition, informed by an updated technical analysis, standards that are more stringent than those that were finalized in 2020 appear economically practicable, based on manageable average per-vehicle cost increases, minimal effects on sales, and estimated increases in employment, as well as higher (and increasing) consumer demand for more fuel economy, among other considerations. NHTSA also believes that the final standards are complementary to other motor vehicle standards of the Government that affect fuel economy that are simultaneously applicable during MYs 2024–2026. The renewed focus on addressing energy conservation and the industry's apparent ability to meet more stringent standards show that a rebalancing of the EPCA factors, and a corresponding issuance of more stringent standards, is appropriate for MYs 2024–2026.

The following sections introduce the action in more detail.

Summary of NPRM

In the NPRM, NHTSA proposed to revise the existing CAFE standards for MYs 2024–2026. NHTSA explained that it was proposing to revise those standards because it had reconsidered its determination made in 2020 about

what levels of CAFE stringency would be maximum feasible for those model years, after reviewing the standards in response to the President's direction in E.O. 13990. NHTSA discussed the differences between the proposal and the 2020 final rule, including NHTSA's tentative conclusion that significantly more stringent standards would be maximum feasible, based on a reconsideration of how to balance the relevant statutory considerations and updated technical information. NHTSA also discussed the fact that it was issuing the proposal independently, unlike several past rulemakings in which NHTSA and EPA had issued joint proposals. NHTSA explained that EPA's revised standards apply to MY 2023 as well as MYs 2024–2026, while NHTSA's 18-month lead time requirement precluded amendment of the MY 2023 CAFE standards. An important consequence of this was that EPA's proposed rate of stringency increase, after taking a big leap in MY 2023, looked slower than NHTSA's over the same time period. NHTSA emphasized, however, that the proposed standards were what NHTSA believed best fulfilled our statutory directive of energy conservation, and that the agencies had worked closely together in developing their respective proposals, and that by the end of the rulemaking time frame, alignment would be achieved between the two agencies' standards. NHTSA also explained that it had employed an analytical baseline for the NPRM that included both a representation of the California ZEV program (and its adoption in a number of states) and the California “Framework Agreements” between that state and BMW, Ford, Honda, Volkswagen of America (VWA), and Volvo. NHTSA also described other analytical improvements made for the NPRM since the 2020 final rule.

NHTSA proposed CAFE standards for MYs 2024–2026 that would increase at a rate of 8 percent per year, for both passenger cars and light trucks, and also took comment on a wide range of alternatives, including retaining the 2020 standards and returning to levels consistent with what was set forth in the 2012 final rule. Table II–1 and Table II–2 below contain descriptions of the regulatory alternatives on which comment was sought, and the estimated translation of those alternatives into mpg levels, respectively, for the reader's reference. The proposal was accompanied by a Preliminary Regulatory Impact Analysis (PRIA), a Draft Supplemental Environmental Impact Statement (Draft SEIS), and the

²⁰ 84 FR 7037 (Jan. 25, 2021).

²¹ *Id.*, sections 1, 2.

²² *Id.*, section 1.

²³ *Id.*, section 2(a)(ii).

CAFE Model software source code and documentation, all of which were also subject to comment in their entirety and all of which received significant comments.

Table II-1 – Regulatory Alternatives Considered in the Proposal

Regulatory Alternative	Year-Over-Year Stringency Increases (Passenger Cars)			Year-Over-Year Stringency Increases (Light Trucks)		
	2024	2025	2026	2024	2025	2026
Alternative 0 (Baseline)	1.5%	1.5%	1.5%	1.5%	1.5%	1.5%
Alternative 1	9.14%	3.26%	3.26%	11.02%	3.26%	3.26%
Alternative 2 (Proposed)	8%	8%	8%	8%	8%	8%
Alternative 3	10%	10%	10%	10%	10%	10%

Table II-2 – Estimated Required Average Fuel Economy (mpg) under Regulatory Alternatives Considered in the Proposal

Regulatory Alternative	Passenger Cars			Light Trucks		
	2024	2025	2026	2024	2025	2026
Alternative 0 (Baseline)	45.9	46.6	47.3	32.9	33.5	33.9
Alternative 1	49.8	51.5	53.2	36.4	37.7	39.0
Alternative 2 (Proposed)	49.2	53.4	58.1	35.1	38.2	41.5
Alternative 3	50.2	55.8	62.0	35.9	39.9	44.3

NHTSA also sought comment on another potential alternative, the effects of which were not expressly quantified, under which MYs 2024–2025 would increase at 8 percent per year, but MY 2026 would increase at 10 percent per year. NHTSA explained that average requirements and achieved CAFE levels would ultimately depend on manufacturers' and consumers' responses to standards, technology developments, economic conditions, fuel prices, and other factors. NHTSA estimated that over the lives of vehicles produced prior to MY 2030, the proposal would save about 50 billion gallons of gasoline and increase electricity consumption (as the percentage of electric vehicles increased over time) by about 275 terawatts (TWh), compared to the levels of gasoline and electricity consumption that NHTSA projected would occur under the baseline standards. Accounting for emissions from both vehicles and upstream energy sector processes, NHTSA estimated that the proposal would reduce greenhouse gas

emissions by about 465 million metric tons of carbon dioxide, about 500 thousand metric tons of methane, and about 12 thousand metric tons of nitrous oxide. NHTSA also estimated that emissions of criteria pollutants would generally decline dramatically over time.

In terms of economic effects, NHTSA estimated that for an average MY 2029 vehicle subject to the proposed standards, consumers could see a price increase of \$960, but would gain lifetime fuel savings of \$1,280. With the SC–GHG discounted at 2.5 percent and other benefits and costs discounted at 3 percent, NHTSA estimated that costs and benefits could be approximately \$120 billion and \$121 billion, respectively, such that the present value of aggregate net benefits to society could be somewhat less than \$1 billion. With the SC–GHG discounted at 3 percent and other benefits and costs discounted at 7 percent, NHTSA estimated approximately \$90 billion in costs and \$76 billion in benefits, such that the present value of aggregate net costs to

society could be approximately \$15 billion.

NHTSA explained that it tentatively concluded that Alternative 2 was maximum feasible for MYs 2024–2026 based on new information and a reconsideration of how to interpret and balance the statutory factors, as compared to the decision made in the 2020 final rule. The 2020 rule had prioritized industry concerns and sought to reduce new vehicle costs to consumers, based on assumptions about low consumer demand for higher fuel economy vehicles and a discounting of the need of the U.S. to conserve energy. In the NPRM, NHTSA recognized the importance of the need of the U.S. to conserve energy, and tentatively concluded that ongoing manufacturer announcements and rollouts of new higher-fuel-economy vehicles indicated industry expectation of growing consumer demand for those vehicles, such that more stringent standards could be economically practicable. NHTSA underscored that “an [a]gency is entitled to change its interpretation of

a statute,”²⁴ even though “[w]hen an [a]gency adopts a materially changed interpretation of a statute, it must in addition provide a ‘reasoned analysis’ supporting its decision to revise its interpretation.”²⁵

NHTSA also addressed the question of harmonization with other motor vehicle standards of the Government that affect fuel economy. Even though NHTSA and EPA issued separate rather than joint notices, NHTSA explained that it had worked closely with EPA in developing the respective proposals, and that the agencies had sought to minimize inconsistency between the programs where doing so was consistent with the agencies’ respective statutory mandates. NHTSA emphasized that differences between the proposals, especially as regards programmatic flexibilities, were not new in the proposal, and that differences were often a result of the different statutory frameworks. NHTSA reminded readers that since the agencies had begun regulating concurrently under President Obama, these differences have meant that manufacturers have had (and will have) to plan their compliance strategies considering both the CAFE standards and the GHG standards and assure that they are in compliance with both. NHTSA explained that it was proposing CAFE standards that would increase at 8 percent per year over MYs 2024–2026 because that was what NHTSA had tentatively concluded was maximum feasible during those model years, under the EPCA factors.

NHTSA was also confident that industry would still be able to build a single fleet of vehicles to meet both the NHTSA and EPA standards, even if it required them to be slightly more strategic than they might otherwise have preferred. NHTSA sought comment broadly on all aspects of the proposal.

B. Public Participation Opportunities and Summary of Comments

The NPRM was published on NHTSA’s website on August 10, 2021, and published in the **Federal Register** on September 3, 2021,²⁶ beginning a 60-day comment period. The agency left the docket open for considering late comments to the extent practicable. A separate **Federal Register** notification,

²⁴ *Phoenix Hydro Corp. v. FERC*, 775 F.2d 1187, 1191 (D.C. Cir. 1985).

²⁵ *Alabama Educ. Ass’n v. Chao*, 455 F.3d 386, 392 (D.C. Cir. 2006) (quoting *Motor Vehicle Mfrs. Ass’n of U.S., Inc. v. State Farm Mut. Auto. Ins. Co.*, 463 U.S. 29, 57 (1983)); see also *Encino Motorcars, LLC v. Navarro*, 136 S. Ct. 2117, 2125 (2016) (“Agencies are free to change their existing policies as long as they provide a reasoned explanation for the change.”) (citations omitted).

²⁶ 86 FR 49602 (Sept. 3, 2021).

also published on September 14, 2021 (86 FR 51092), announced a virtual public hearing taking place on October 13th and 14th of 2021. Approximately 77 individuals and organizations signed up to participate in the hearing. The hearing started at 9:30 a.m. EDT on October 13th and ended at approximately 5:30 p.m., completing the entire list of participants within a single day, resulting in a 58-page transcript.²⁷ The hearing also collected many pages of comments from participants, in addition to the hearing transcript, all of which were submitted to the docket for the rule.

Besides the comments submitted as part of the public hearings, NHTSA’s docket received a total of 67,256 form letters, 1,636 individual comments from stakeholder organizations, and 693 attachments in response to the proposal, for an overall total of 69,585 submissions. NHTSA also received several hundred comments on its Draft SEIS to the separate Draft SEIS docket (NHTSA–2021–0054). While the majority of individual comments were form letters, the agency received over 6,000 pages of substantive comments on the proposal.

Many commenters generally supported the proposal. Commenters supporting the proposal tended to cite concerns about climate change, which are relevant to the need of the United States to conserve energy, and the need for Federal programs to continue or expand for a carbon-neutral, carbon-free future. Commenters also expressed the need for NHTSA and EPA harmonization and close coordination for their respective programs. Citizens and environmental groups demonstrated strong support for pushing the proposed standard to Alternative 3 or beyond, while closing potential loopholes in the program. There were mixed views on NHTSA’s inclusion of battery electric vehicles in NHTSA’s modeling analysis. Many manufacturers supported alignment with EPA’s proposed standards, while electric vehicle manufacturers such as Tesla and Rivian supported NHTSA’s Alternative 3.

In other areas, commenters expressed mixed views on the statutorily mandated Petroleum Equivalency Factor (PEF) used to calculate mpg values for electrified vehicles and the disclosure of credit trading information in NHTSA’s revised reporting templates.

Discussion and responses to comments can be found throughout this preamble in areas applicable to the comment received.

²⁷ The transcript is available in the docket for this rule.

Nearly every aspect of the NPRM’s analysis and discussion received some level of comment by at least one commenter. The comments received, as a whole, were both broad and deep, and the agency appreciates the level of engagement of commenters in the public comment process and the information and opinions provided.

C. Changes in Light of Public Comments and New Information

Comments received to the NPRM were considered carefully, because they are critical for understanding stakeholders’ positions, as well as for gathering additional information that can help to inform the agency about aspects or effects of the proposal that the agency may not have considered at the time of the proposal. The views, data, requests, and suggestions contained in the comments help us to form solutions and make appropriate adjustments to our proposals so that we may be better assured that the final standards we set are, indeed, maximum feasible for the rulemaking time frame.

For this final rule, the agency made substantive changes resulting directly from the suggestions and recommendations from commenters, as well as new information obtained from the time the proposal was developed, and corrections both highlighted by commenters and discovered internally. These changes reflect DOT’s long-standing commitment to ongoing refinement of its approach to estimating the potential impacts of new CAFE standards. Through further consideration and deliberation, and also in response to many public comments received since then, NHTSA has made a number of changes to the CAFE Model since the 2020 final rule, including those that are listed in the Executive Summary and detailed in Section III, as well as in the TSD and FRIA that accompany this final rule.

D. Final Standards—Stringency

NHTSA is setting CAFE standards for passenger cars and light trucks manufactured for sale in the United States in MYs 2024–2026. Passenger cars are generally sedans, station wagons, and two-wheel drive crossovers and sport utility vehicles (CUVs and SUVs), while light trucks are generally 4WD sport utility vehicles, pickups, minivans, and passenger/cargo vans.²⁸ The final standards, represented by Alternative 2.5 in NHTSA’s analysis, increase at a rate of 8 percent per year for both cars and trucks for MYs 2024–

²⁸ “Passenger car” and “light truck” are defined at 49 CFR part 523.

2025, and at a rate of 10 percent for MY 2026 cars and trucks. The final standards, like the proposed standards, are defined by a mathematical equation that represents a constrained linear function relating vehicle footprint to fuel economy targets for both cars and trucks.²⁹

The target curves for passenger cars and light trucks are as follows; curves for MYs 2020–2023 are included in the figures for context. NHTSA underscores that the equations and coefficients defining the curves are, in fact, the CAFE standards, and not the mpg numbers that the agency currently

estimates could result from manufacturers complying with the curves. Because the estimated mpg numbers are an *effect* of the final standards, they are presented in Section II.E.

BILLING CODE 4910–59–P

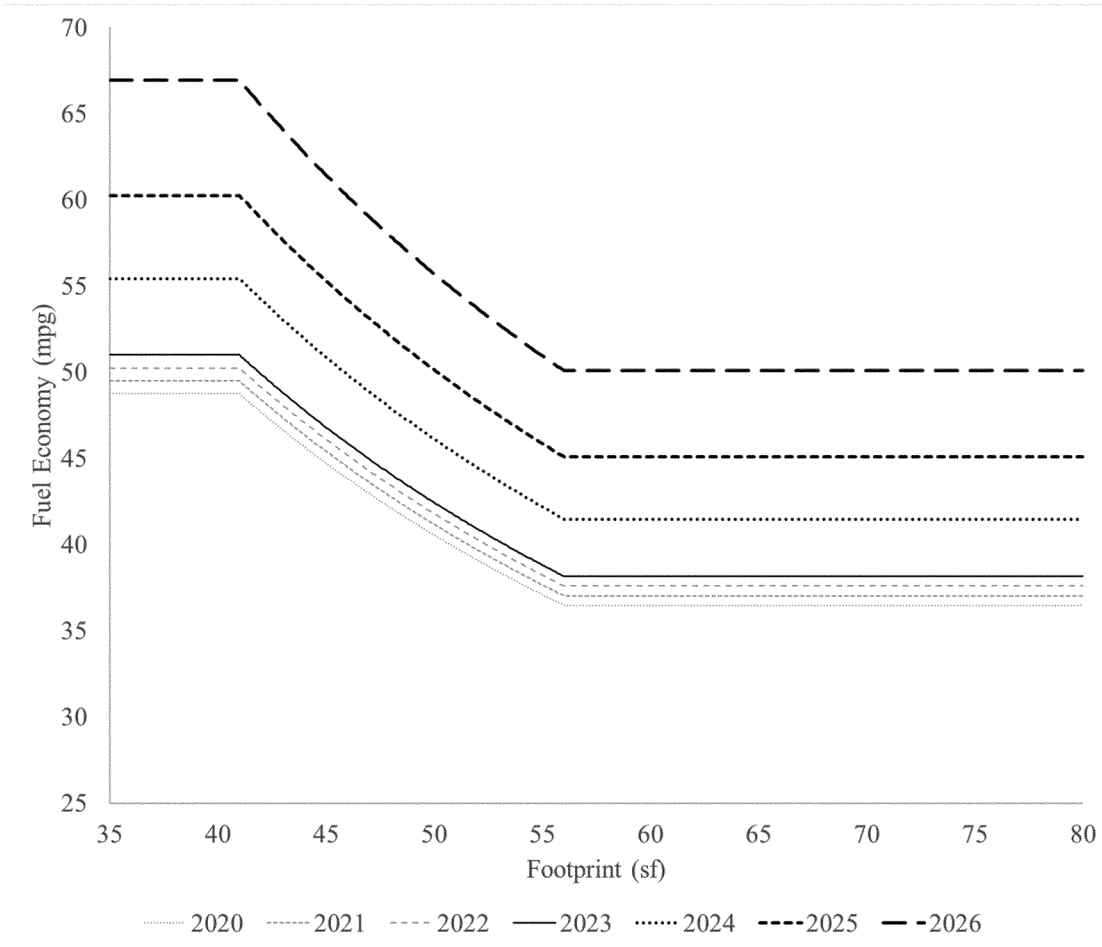

Figure II-1 – Final Passenger Car Standards, Target Curves

²⁹ Vehicle footprint is roughly measured as the rectangle that is made by the four points where the vehicle’s tires touch the ground. Generally, passenger cars have more stringent targets than light

trucks regardless of footprint, and smaller vehicles will have more stringent targets than larger vehicles. No individual vehicle or vehicle model need meet its target exactly, but a manufacturer’s

compliance is determined by how its average fleet fuel economy compares to the average fuel economy of the targets of the vehicles it manufactures.

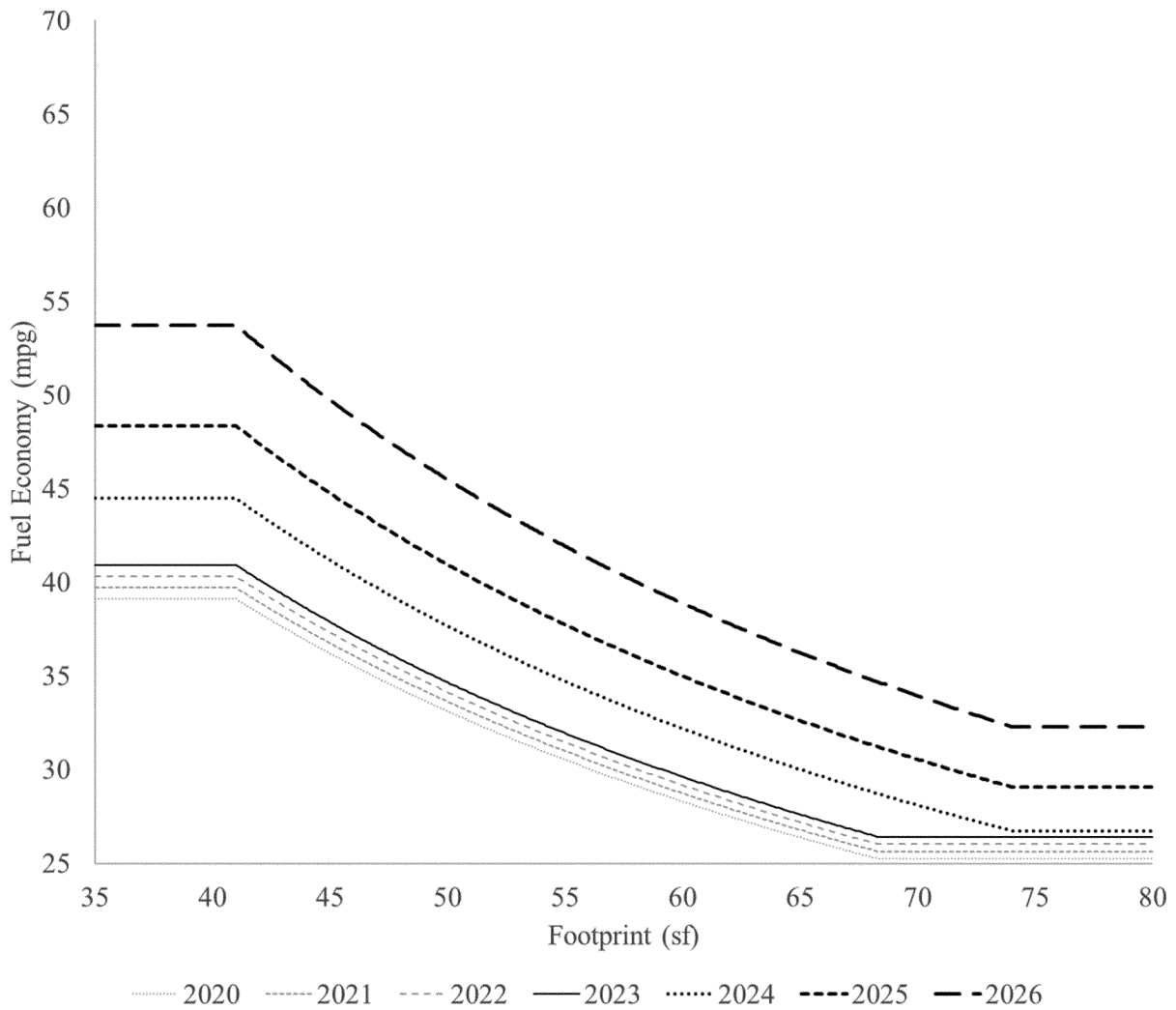

Figure II-2 – Final Light Truck Standards, Target Curves

NHTSA has also amended the minimum domestic passenger car CAFE standards for MYs 2024–2026. Section 32902(b)(4) of 49 U.S.C. requires NHTSA to project the minimum

standard when it promulgates passenger car standards for a model year, so the minimum standards are established as specific mpg values at this time. NHTSA retained the 1.9-percent offset used in

the 2020 final rule, such that the minimum domestic passenger car standard is as shown in Table II-3.

Table II-3 – Final Minimum Domestic Passenger Car Standard

2024	2025	2026
44.3 mpg	48.2 mpg	53.5 mpg

The next section describes some of the effects that NHTSA estimates would follow from the final standards for passenger cars and light trucks for MYs 2024–2026, including how the curves shown above translate to estimated average mile per gallon requirements for the industry.

Final Standards—Impacts

As for past CAFE rulemakings, NHTSA has used the CAFE Model to estimate the effects of this final rule's CAFE standards, and of other regulatory alternatives under consideration. Some inputs to the CAFE Model are derived from other models, such as Argonne National Laboratory's "Autonomie" vehicle simulation tool and Argonne's "GREET" fuel-cycle emissions analysis model, the U.S. Energy Information Administration's (EIA's) National

Energy Modeling System (NEMS), and EPA's "MOVES" vehicle emissions model. Especially given the scope of the NHTSA's analysis (through MY 2050, with driving of MY 2029 vehicles accounted for through CY 2068), these inputs involve a multitude of uncertainties. For example, a set of inputs with significant uncertainty could include future population and economic growth, future gasoline and electricity prices, future petroleum market characteristics (*e.g.*, imports and exports), future battery costs, manufacturers' future responses to standards and fuel prices, buyers' future responses to changes in vehicle prices and fuel economy levels, and future emission rates for "upstream" processes (*e.g.*, refining, finished fuel transportation, electricity generation).

Considering that all of this is, to some extent, uncertain from a current vantage point, NHTSA underscores that all results of this analysis are, in turn, uncertain, and simply represent the agency's best estimates based on the information currently before us and on the agency's reasonable judgment.

NHTSA estimates that this final rule would increase the eventual³⁰ average of manufacturers' CAFE requirements to about 49 mpg by 2026 rather than, under the No-Action Alternative (*i.e.*, the baseline standards issued in 2020), about 40 mpg. For passenger cars, the average in 2026 is estimated to reach just over 59 mpg, and for light trucks, just over 42 mpg. This compares with 47 mpg and 34 mpg for cars and trucks, respectively, under the No-Action Alternative.

Table II-4 – Estimated Average of CAFE Levels (mpg) Required Under Final Rule

Fleet	2024	2025	2026	2027	2028	2029
Passenger Cars	49.2	53.4	59.4	59.4	59.3	59.3
Light Trucks	35.1	38.2	42.4	42.4	42.4	42.4
Overall Fleet	40.6	44.2	49.1	49.1	49.2	49.3

Because manufacturers do not comply exactly with each standard in each model year, but rather focus their compliance efforts when and where it is most cost-effective to do so, "estimated

achieved" fuel economy levels differ somewhat from "estimated required" levels for each fleet, for each year. NHTSA estimates that the industry-wide average fuel economy achieved in

MY 2029 could increase from about 44 mpg under the No-Action Alternative to 50 mpg under the final rule's standards.

Table II-5 – Estimated Average of CAFE Levels (mpg) Achieved Under Final Rule

Fleet	2024	2025	2026	2027	2028	2029
Passenger Cars	54.7	57.9	60.9	61.8	62.5	62.6
Light Trucks	36.8	38.0	40.7	41.4	41.8	42.1
Overall Fleet	43.5	45.4	48.4	49.1	49.7	50.0

As discussed above, NHTSA's analysis—unlike its CAFE analyses for previous rulemakings—estimates manufacturers' potential responses to the combined effect of CAFE standards and separate CO₂ standards (including agreements some manufacturers have reached with California), ZEV mandates, and fuel prices. Together, the

forementioned regulatory programs are more binding (*i.e.*, require more of manufacturers) than any single program considered in isolation, and this analysis, like past analyses, shows some estimated overcompliance with the final CAFE standards, albeit by much less than what was shown in the NPRM that preceded the 2020 final rule, and any

overcompliance is highly manufacturer-dependent.

The estimated average CO₂ levels equivalent to the above required and achieved CAFE levels (using 8,887 grams of CO₂ per gallon of gasoline vehicle certification fuel) are provided in Table II-6 and Table II-7.

³⁰ Here, "eventual" means by MY 2029, after most of the fleet will have been redesigned under the MY 2026 standards. NHTSA allows the CAFE Model to

continue working out compliance solutions for the regulated model years for three model years after the last regulated model year, in recognition of the

fact that manufacturers do not comply perfectly with CAFE standards in each model year.

Table II-6 – Estimated CO₂ Levels Equivalent to Average of CAFE Levels Required Under Final Rule (Gram per Mile CO₂ Levels)

Fleet	2024	2025	2026	2027	2028	2029
Passenger Cars	181	166	150	150	150	150
Light Trucks	253	233	210	210	210	210
Overall Fleet	219	201	181	181	181	180

Table II-7 – Estimated CO₂ Levels Equivalent to Average of CAFE Levels Achieved Under Final Rule (Gram per Mile CO₂ Levels)

Fleet	2024	2025	2026	2027	2028	2029
Passenger Cars	162	153	146	144	142	142
Light Trucks	241	234	218	215	213	211
Overall Fleet	204	196	184	181	179	178

Average requirements and achieved CAFE levels would ultimately depend on manufacturers’ and consumers’ responses to standards, technology developments, economic conditions, fuel prices, and other factors.

NHTSA estimates that over the lives of vehicles produced prior to MY 2030, the final standards would save about 60 billion gallons of gasoline and increase electricity consumption (as the percentage of electric vehicles increases

over time) by about 180 terawatts (TWh), compared to levels of gasoline and electricity consumption NHTSA projects would occur under the baseline standards (*i.e.*, the No-Action Alternative) as shown in Table II–8.³¹

Table II-8 – Estimated Changes in Energy Consumption vs. No-Action Alternative

Energy Source	Change in Consumption
Gasoline	-60 billion gallons
Electricity	+180 TWh

NHTSA’s analysis also estimates total annual consumption of fuel by the entire on-road fleet from CY 2020 through CY 2050. On this basis, gasoline and electricity consumption by the U.S.

light-duty vehicle fleet evolves as shown in Figure II–3 and Figure II–4, each of which shows projections for the No-Action Alternative (Alternative 0, *i.e.*, the baseline), Alternative 1,

Alternative 2, Alternative 2.5 (the Preferred Alternative), and Alternative 3.

³¹ While NHTSA does not consider electrification in its analysis during the rulemaking time frame, the analysis still reflects application of electric

vehicles in the baseline fleet and during the model years after the rulemaking time frame, such that electrification (and thus, electricity consumption)

increases in NHTSA’s analysis even though NHTSA is not considering it in our decision-making.

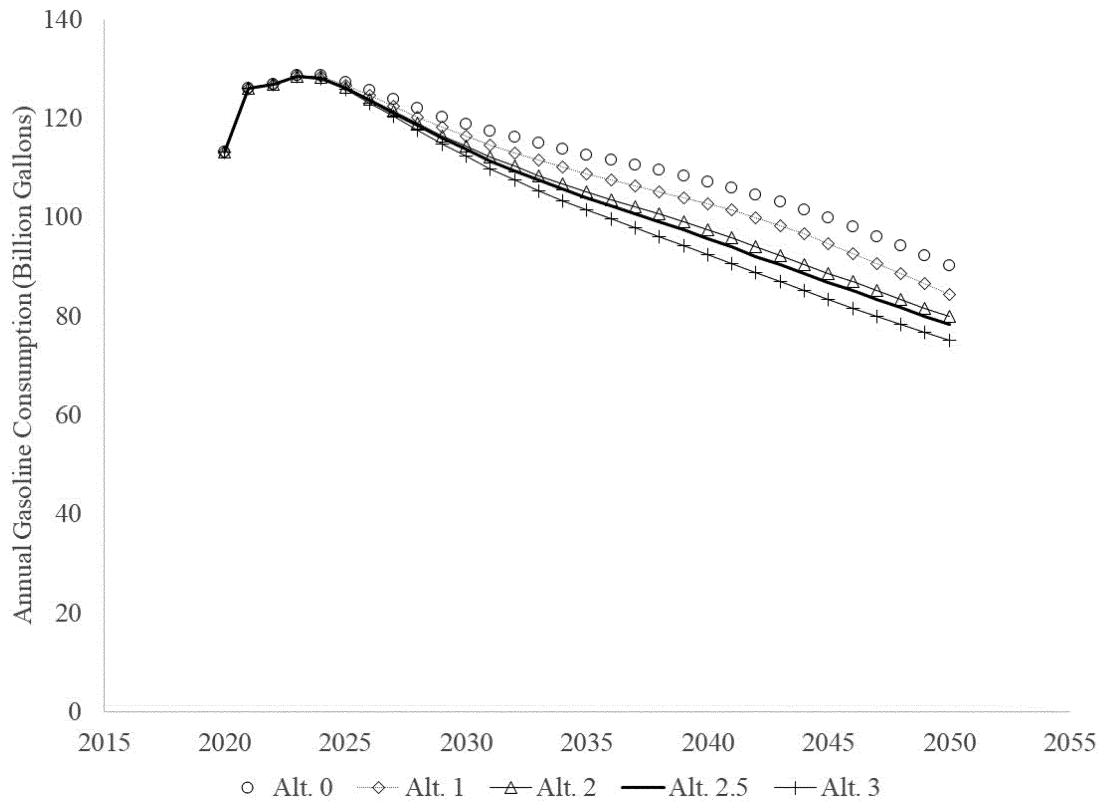

Figure II-3 – Estimated Annual Gasoline Consumption by Light-Duty On-Road Fleet

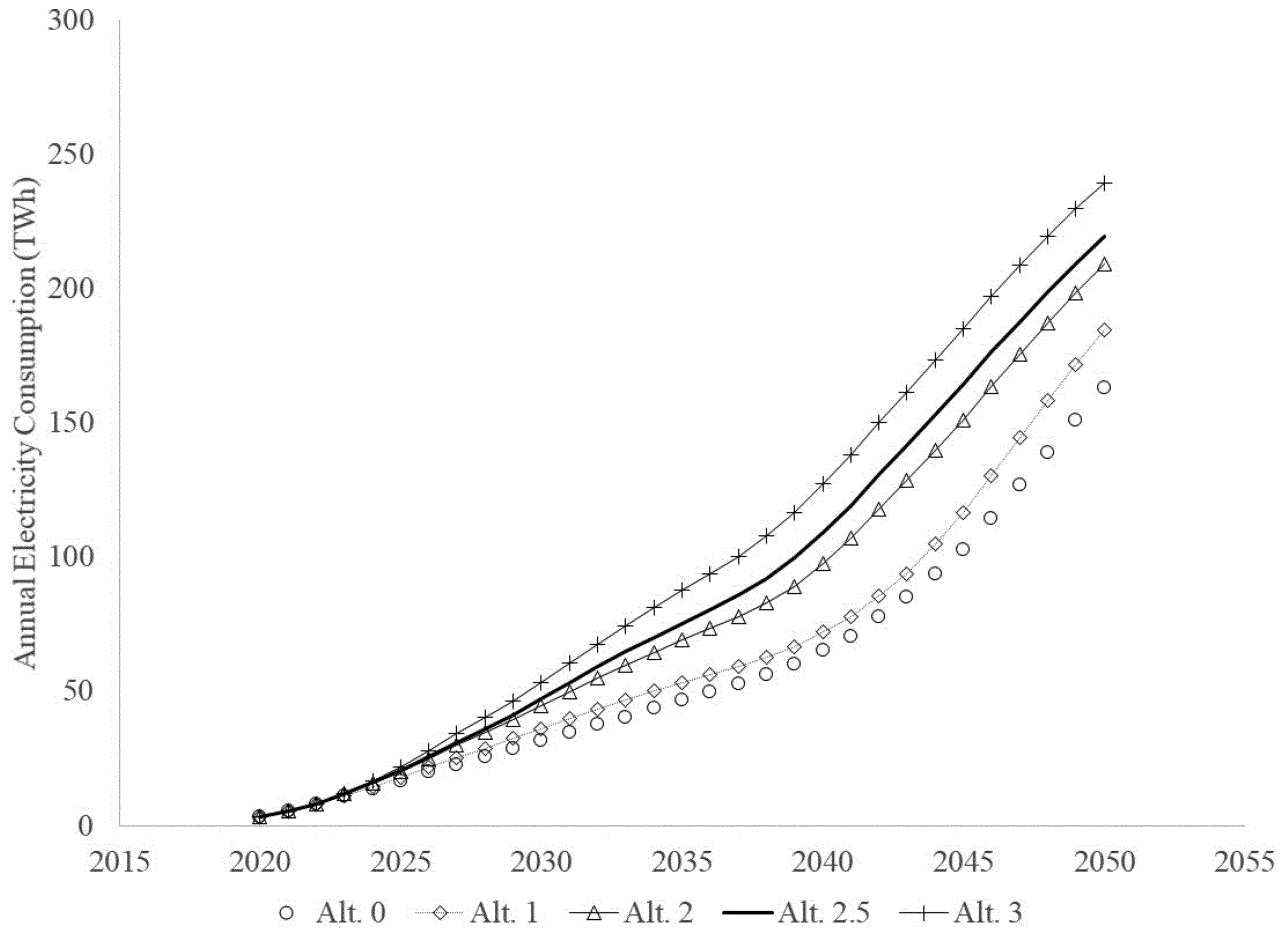

Figure II-4 – Estimated Electricity Consumption by Light-Duty On-Road Fleet

Accounting for emissions from both vehicles and upstream energy sector processes (e.g., petroleum refining and electricity generation), which are relevant to NHTSA’s evaluation of the

need of the United States to conserve energy, NHTSA estimates that the final rule would reduce greenhouse gas emissions by about 607 million metric tons of carbon dioxide (CO₂), about 733

thousand metric tons of methane (CH₄), and about 17 thousand tons of nitrous oxide (N₂O).

BILLING CODE 4910-59-P

Table II-9 – Estimated Changes in Greenhouse Gas Emissions (Metric Tons) vs. No-Action Alternative, MYs 1981-2029, Total Vehicle Lifetimes

Greenhouse Gas	Change in Emissions
Carbon Dioxide (CO ₂)	-607 million tons
Methane (CH ₄)	-733 thousand tons
Nitrous Oxide (N ₂ O)	-17 thousand tons

As for fuel consumption, NHTSA’s analysis also estimates annual emissions attributable to the entire on-road fleet from CY 2020 through CY 2050. Also

accounting for both vehicles and upstream processes, NHTSA estimates that CO₂ emissions could evolve over time as shown in Figure II-5, which

accounts for both emissions from both vehicles and upstream processes.

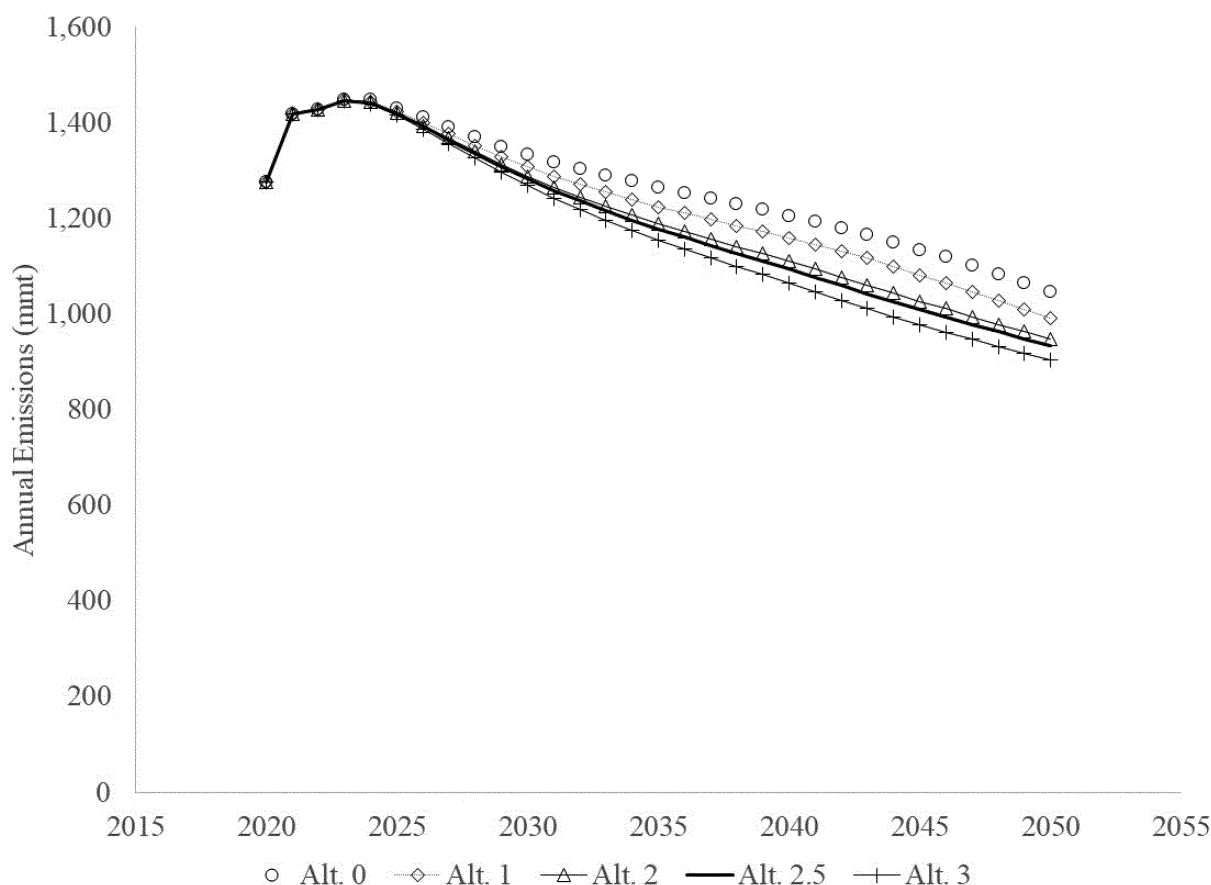

Figure II-5 – Estimated Annual CO₂ Emissions Attributable to Light-Duty On-Road Fleet

BILLING CODE 4910-59-C

Estimated emissions of methane and nitrous oxides follow similar trends. As discussed in the TSD, FRIA, and this preamble, NHTSA has performed two types of supporting analysis. This document and FRIA focus on the “standard setting” analysis, which sets aside the potential that manufacturers could respond to standards by using compliance credits or introducing new alternative fuel vehicle (including BEVs) models during the “decision years” (for this document, 2024, 2025, and 2026). The accompanying Final SEIS focuses

on an “unconstrained” analysis, which does not set aside these potential manufacturer actions. The Final SEIS presents much more information regarding projected GHG emissions, as well as model-based estimates of corresponding impacts on several measures of global climate change.

Also accounting for vehicular and upstream emissions, NHTSA has estimated annual emissions of most criteria pollutants (*i.e.*, pollutants for which EPA has issued National Ambient Air Quality Standards). NHTSA estimates that under each

regulatory alternative, annual emissions of carbon monoxide (CO), volatile organic compounds (VOC), nitrogen oxide (NO_x), and particulate matter with a diameter equal to or less than 2.5 microns (PM_{2.5}) attributable to the light-duty on-road fleet will decline dramatically between 2020 and 2050, and that emissions in any given year could be very nearly the same under each regulatory alternative. For example, Figure II-6 shows NHTSA’s estimate of future NO_x emissions under each alternative.

BILLING CODE 4910-59-P

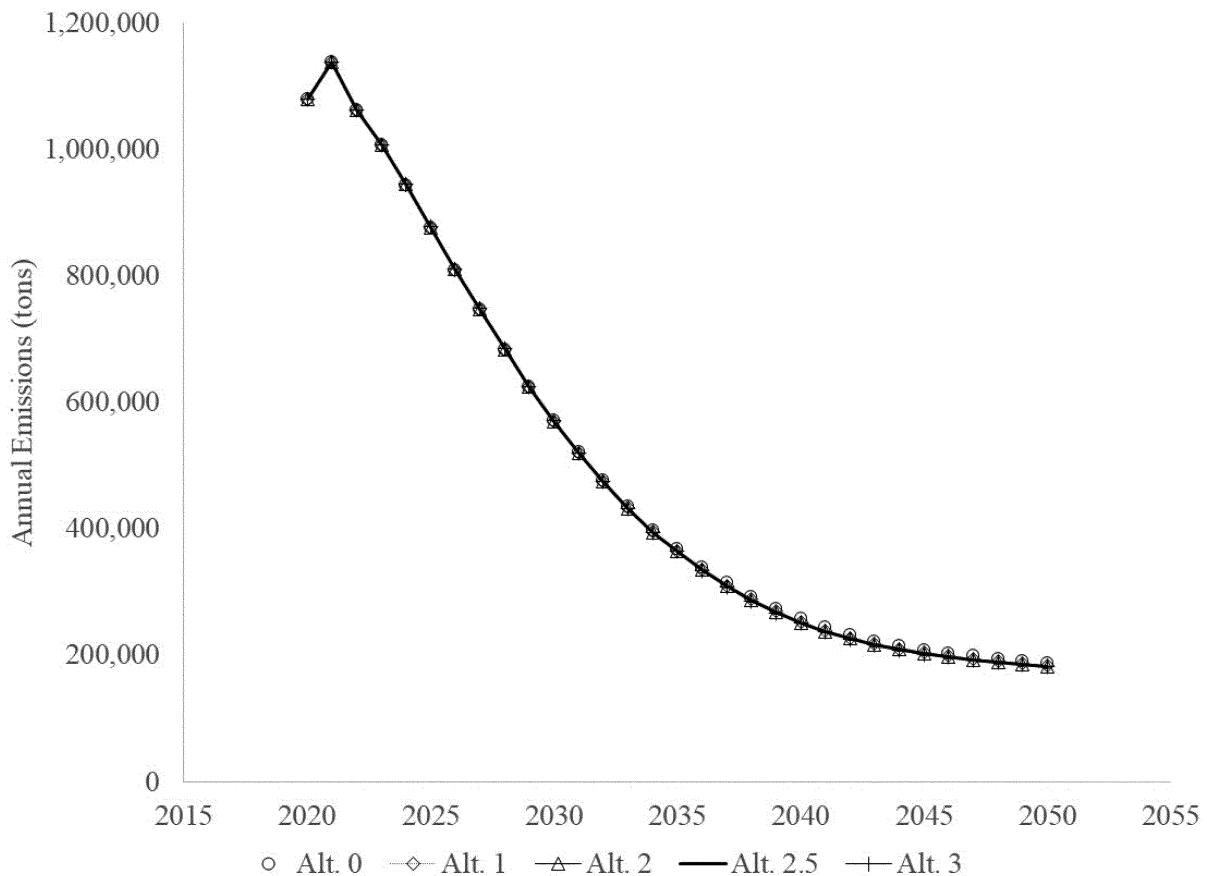

Figure II-6 – Estimated Annual NOX Emissions Attributable to Light-Duty On-Road Fleet

BILLING CODE 4910-59-C

On the other hand, as discussed in the FRIA and Final SEIS, NHTSA projects that annual SO₂ emissions attributable to the light-duty on-road fleet could increase modestly under the action alternatives, because, as discussed above, NHTSA projects that each of the action alternatives could lead to greater use of electricity (for PHEVs and BEVs). The adoption of actions—such as actions prompted by President Biden’s Executive order directing agencies to develop a Federal Clean Electricity and Vehicle Procurement Strategy—to reduce electricity generation emission rates beyond projections underlying NHTSA’s analysis (discussed in Chapter 5 of the TSD) could dramatically reduce SO₂ emissions under all regulatory alternatives considered here.³²

For the “standard setting” analysis, the FRIA accompanying this document provides additional detail regarding projected criteria pollutant emissions and health effects, as well as the inclusion of these impacts in this benefit-cost analysis. For the “unconstrained” or “EIS” type of analysis, the Final SEIS accompanying this document presents much more information regarding projected criteria pollutant emissions, as well as model-based estimates of corresponding impacts on several measures of urban air quality and public health. As mentioned above, these estimates of criteria pollutant emissions are based on a complex analysis involving interacting simulation techniques and a myriad of input estimates and assumptions. Especially extending well past 2040, the

analysis involves a multitude of uncertainties. Therefore, actual criteria pollutant emissions could ultimately be different from NHTSA’s current estimates.

To illustrate the effectiveness of the technology added in response to this final rule, Table II-10 presents NHTSA’s estimates for increased vehicle cost and lifetime fuel expenditures if we assumed the behavioral response to the lower cost of driving were zero.³³ These numbers are presented in lieu of NHTSA’s primary estimate of lifetime fuel savings, which would give an incomplete picture of technological effectiveness because the analysis accounts for consumers’ behavioral response to the lower cost-per-mile of driving a more fuel-efficient vehicle.

³² <https://www.whitehouse.gov/briefing-room/presidential-actions/2021/01/27/executive-order-on-tackling-the-climate-crisis-at-home-and-abroad/> (accessed February 11, 2022).

³³ While this comparison illustrates the effectiveness of the technology added in response to this final rule, it does not represent a full consumer welfare analysis, which would account for drivers’ likely response to the lower cost-per-

mile of driving, as well as a variety of other benefits and costs they will experience. The agency’s complete analysis of the final rule’s likely impacts on passenger car and light truck buyers appears in the FRIA, Appendix I, Table A-23-1.

Table II-10 – Estimated Impact on Average MY 2029 Vehicle Costs vs. No-Action Alternative, 3 Percent Discount Rate

Consumer Impact	Dollar Value
Price Increase	\$1,087
Lifetime Fuel Savings	\$1,377

With the SC-GHG discounted at 3 percent and other benefits and costs discounted at 3 percent, NHTSA estimates that monetized costs and benefits could be approximately \$128 billion and \$145 billion, respectively, such that the present value of aggregate

monetized net benefits to society could be approximately \$16 billion. With the SC-GHG discounted at 3 percent and other benefits and costs discounted at 7 percent, NHTSA estimates approximately \$96 billion in monetized costs and \$100 billion in monetized

benefits could be attributable to vehicles produced prior to MY 2030 over the course of their lives, such that the present value of aggregate net monetized benefits to society could be approximately \$4 billion.

Table II-11 – Estimated Monetized Costs, Benefits, and Net Benefits Across MYs 1981-2029 (billions of dollars), Total Fleet for Alternative 2.5, Average SC-GHG

	Totals		Annualized	
	3% Discount Rate	7% Discount Rate	3% Discount Rate	7% Discount Rate
Costs	128.4	95.8	5.03	6.96
Benefits	144.6	99.7	5.67	7.25
Net Benefits	16.3	3.9	0.64	0.29

The following two tables provides a range of benefits and net benefits representing varying discount rates for

the social cost of carbon with all other

benefits discounted at 3 percent and 7 percent, respectively.

BILLING CODE 4910-59-P

Table II-12 – Incremental Monetized Benefits and Costs Over the Lifetimes of Total Fleet Produced Through 2029 (2018\$ Billions), 3 Percent Discount Rate, by Alternative, All SC-GHG Levels

Alternative	1	2	2.5	3
Total Incremental Social Benefits, Average SC-GHG Values at 5% Discount Rate	68.5	111.1	124.2	156.4
Total Incremental Social Benefits, Average SC-GHG Values at 3% Discount Rate	79.2	129.4	144.6	182.2
Total Incremental Social Benefits, Average SC-GHG Values at 2.5% Discount Rate	86.7	142.2	158.9	200.3
Total Incremental Social Benefits, 95 th Percentile SC-GHG Values at 3% Discount Rate	108.4	179.2	200.3	252.5
Net Incremental Social Benefits, Average SC-GHG Values at 5% Discount Rate	9.9	-2.8	-4.2	-9.4
Net Incremental Social Benefits, Average SC-GHG Values at 3% Discount Rate	20.6	15.5	16.3	16.4
Net Incremental Social Benefits, Average SC-GHG Values at 2.5% Discount Rate	28.1	28.3	30.6	34.5
Net Incremental Social Benefits, 95 th Percentile SC-GHG Values at 3% Discount Rate	49.8	65.2	71.9	86.7

Table II-13 – Incremental Benefits and Costs Over the Lifetimes of Total Fleet Produced Through 2029 (2018\$ Billions), 7 Percent Discount Rate, by Alternative, All SC-GHG Levels

Alternative	1	2	2.5	3
Total Incremental Social Benefits, Average SC-GHG Values at 5% Discount Rate	43.8	71.0	79.3	100.0
Total Incremental Social Benefits, Average SC-GHG Values at 3% Discount Rate	54.5	89.3	99.7	125.8
Total Incremental Social Benefits, Average SC-GHG Values at 2.5% Discount Rate	62.0	102.1	114.1	143.9
Total Incremental Social Benefits, 95th Percentile SC-GHG Values at 3% Discount Rate	83.6	139.0	155.4	196.1
Net Incremental Social Benefits, Average SC-GHG Values at 5% Discount Rate	0.8	-13.9	-16.5	-24.3
Net Incremental Social Benefits, Average SC-GHG Values at 3% Discount Rate	11.5	4.3	3.9	1.5
Net Incremental Social Benefits, Average SC-GHG Values at 2.5% Discount Rate	19.0	17.2	18.3	19.6
Net Incremental Social Benefits, 95th Percentile SC-GHG Values at 3% Discount Rate	40.6	54.1	59.6	71.8

BILLING CODE 4910-59-C

Model results can be viewed many different ways, and NHTSA's rulemaking considers both "model year" and "calendar year" perspectives. The "model year" perspective, above, considers vehicles projected to be produced in some range of model years, and accounts for impacts, benefits, and costs attributable to these vehicles from the present (from the model year's perspective, 2020) until they are projected to be scrapped. The bulk of NHTSA's analysis considers vehicles produced prior to MY 2030, accounting for the estimated indirect impacts new standards could have on the remaining operation of vehicles already in service. This perspective emphasizes impacts on

those model years nearest to those (2024–2026) for which NHTSA is finalizing new standards. NHTSA's analysis also presents some results focused only on MYs 2024–2026, setting aside the estimated indirect impacts on earlier model years, and the impacts estimated to occur during MYs 2027–2029, as some manufacturers and products "catch up" to the standards.

Another way to present the benefits and costs of the final rule is the "calendar year" perspective shown in Table II-14, which is similar to how EPA presents benefits and costs in its final analysis for GHG standards. The calendar year perspective considers all vehicles projected to be in service in

each of some range of future calendar years. NHTSA's presentation of results from this perspective considers CYs 2021–2050, because the model's representation of the full on-road fleet extends through 2050. Unlike the model year perspective, this perspective includes vehicles projected to be produced during MYs 2021–2050. This perspective emphasizes longer-term impacts that could accrue if standards were to continue without change. Under the calendar year perspective, net benefits for the standards are estimated to be nearly \$112 billion by 2050 at a 3 percent discount rate, and over \$73 billion by 2050 at a 7 percent discount rate.

Table II-14 – Estimated Costs, Benefits, and Net Benefits Across CYs 2021-2050 (billions of dollars), Total Fleet for Alternative 2.5, Average SC-GHG

	Totals		Annualized	
	3% Discount Rate	7% Discount Rate	3% Discount Rate	7% Discount Rate
Costs	366.8	218.7	18.71	17.63
Benefits	478.5	292.1	24.41	23.54
Net Benefits	111.7	73.3	5.70	5.91

Finally, Table II–15 shows costs and benefits over the narrow perspective of the lives of MY 2023–2026 vehicles

while Table II–11 shows a wider perspective of the costs and benefits

over the remaining lives of all vehicles produced through MY 2029.

Table II–15 – Estimates of Benefits and Costs (\$b) of the Preferred Alternative for MYs 2023 through 2026, 3 Percent Discount Rate, Average SC-GHG

MY	Cost	Benefit	Net Benefits
		Present Values	
2023	5.1	4.5	-0.6
2024	10.4	13.8	3.3
2025	13.9	19.9	6.0
2026	18.9	28.9	10.0
Sum	48.3	67.0	18.7

Though based on the exact same model results, these two perspectives provide considerably different views of estimated costs and benefits. Because technology costs account for a large share of overall estimated costs, and are also projected to decline over time (as manufacturers gain more experience with new technologies), costs tend to be “front loaded”—occurring early in a vehicle’s life and tending to be higher in earlier model years than in later model years. Conversely, because social benefits of standards occur as vehicles are driven, and because both fuel prices and the social cost of CO₂ emissions are projected to increase in the future, benefits tend to be “back loaded.” As a result, estimates of future fuel savings, CO₂ reductions, and net social benefits are higher under the calendar year perspective than under the model year perspective. On the other hand, with longer-term impacts playing a greater role, the calendar year perspective is more subject to uncertainties regarding, for example, future technology costs and fuel prices.

Even though NHTSA and EPA estimate benefits, costs, and net benefits using similar methodologies and achieve similar results, different approaches to accounting may give the false appearance of significant divergences. Table II–13 above presents NHTSA’s results using comparable accounting to EPA’s preamble Table 4. EPA also presents cost and benefit information in its RIA over CYs 2021 through 2050.³⁴ The numbers most comparable to those presented in EPA’s RIA are those NHTSA developed to

complete its Final SEIS using an identical accounting approach. This is because the statutory limitations constraining NHTSA’s standard setting analysis, such as those in 49 U.S.C. 32902(h), do not similarly apply to its “unconstrained” analysis, some effects of which are used in NHTSA’s Final SEIS.³⁵ NHTSA’s “unconstrained” analysis estimates \$312 billion in monetized costs, \$443 billion in monetized benefits, and \$132 billion in monetized net benefits using a 3-percent discount rate over CYs 2021 through 2050, with the social cost of carbon discounted at 3 percent.³⁶ NHTSA describes its cost and benefit accounting approach in Section V of this preamble.

Final Standards Are the Maximum Feasible

NHTSA’s conclusion, after consideration of the factors described below and information in the administrative record for this action, is that 8-percent increases in stringency for MYs 2024–2025 and a 10-percent increase for MY 2026 for both passenger cars and light trucks (Alternative 2.5 of this analysis) are maximum feasible. The Department of Transportation is deeply committed to working aggressively to improve energy conservation and reduce environmental harms and economic and security risks

associated with energy use. NHTSA agrees with many public comments suggesting that the need of the United States to conserve energy and protect the environment compels more stringent standards than those set in 2020 if they appear to be consistent with the other factors that NHTSA must consider. NHTSA has concluded that Alternative 2.5 is technologically feasible, is economically practicable (based on manageable average per-vehicle cost increases, minimal effects on sales, and estimated increases in employment, among other considerations), and is complementary to other motor vehicle standards of the Government on fuel economy that are simultaneously applicable during MYs 2024–2026, as described in more detail below. Despite only 2 years having passed since the 2020 final rule, enough has changed in the United States and the world, including as reflected in the technical analysis, that revisiting the CAFE standards for MYs 2024–2026, and raising their stringency considerably, is both appropriate and reasonable.

The 2020 final rule set CAFE standards that increased at 1.5 percent per year for cars and trucks for MYs 2021–2026, in large part because it prioritized industry concerns and reducing upfront costs to consumers and manufacturers—even at the expense of longer-term net savings to consumers. This final rule reflects greater emphasis on the statutory priority of energy conservation, while also taking into account other statutory requirements. Moreover, NHTSA is also legally required to consider the environmental implications of this action under NEPA, and while the 2020 final rule did undertake a NEPA analysis, it did not prioritize the environmental

³⁴ EPA’s RIA is available at <https://www.epa.gov/regulations-emissions-vehicles-and-engines/final-rule-revise-existing-national-ghg-emissions> (accessed: March 24, 2022).

³⁵ As the Final SEIS analysis contains information that NHTSA is statutorily prevented from considering, the agency is limited on the extent this analysis is used in regulatory decision-making. Additionally, the Final SEIS includes no cost and benefit analysis, and does not rely in any way on the social cost of greenhouse gas emissions.

³⁶ See FRIA Chapter 6.5 for more information regarding NHTSA’s estimates of annual benefits and costs using NHTSA’s standard setting analysis. See Tables B–7–25 through B–7–30 in Appendix II of the FRIA for a more detailed breakdown of NHTSA’s Final SEIS analysis.

considerations encompassed within the statutory mandate to set “maximum feasible” fuel economy standards to conserve energy. This rule also reflects NHTSA’s updated technical analysis.

NHTSA recognizes that the amount of lead time available before MY 2024 is less than what was provided in the 2012 rule. The amount of lead time is nevertheless consistent with the agency’s statutory requirements. As will be discussed further in Section VI, NHTSA believes that the evidence suggests that the final standards are economically practicable as explained above and as discussed in Section VI.

We note further that while this final rule is different from the 2020 final rule (and also from the 2012 final rule), NHTSA, like any other Federal agency, is afforded an opportunity to reconsider prior views and, when warranted, to adopt new positions. Indeed, as a matter of good governance, agencies *should* revisit their positions when appropriate, especially to ensure that their actions and regulations reflect legally sound interpretations of the agency’s statutory authority and remain consistent with the agency’s policy views and practices. As a matter of law, “an [agency] is entitled to change its interpretation of a statute.”³⁷ Nonetheless, “[w]hen an [agency] adopts a materially changed interpretation of a statute, it must in addition provide a ‘reasoned analysis’ supporting its decision to revise its interpretation.”³⁸ This preamble and the accompanying TSD and FRIA all provide extensive detail on the agency’s updated analysis, and Section VI contains the agency’s explanation of how the agency has considered that analysis and other relevant information in determining that the standards represented by Alternative 2.5 are maximum feasible for MY 2024–2026 passenger cars and light trucks.

Final Standards Are Feasible in the Context of EPA’s Final Standards and California’s Programs

The NHTSA and EPA final rules remain coordinated despite being issued as separate regulatory actions. Because NHTSA and EPA are regulating the exact same vehicles and manufacturers will use many of the same technologies to meet both sets of standards, NHTSA coordinated with EPA during the

development of each agency’s independent rulemaking to revise their respective standards set forth in the 2020 final rule. The NHTSA CAFE and EPA CO₂ standards for MY 2026 represent roughly equivalent levels of stringency. While the rates of increase for the final CAFE and CO₂ standards for MYs 2024–2026 are different, the specific differences in what the two agencies’ standards require become smaller each year, until near alignment is achieved in 2026. NHTSA nevertheless coordinated closely with EPA to minimize inconsistency between the programs while still ensuring that NHTSA’s standards were maximum feasible for MYs 2024–2026.

While NHTSA’s and EPA’s programs differ in certain other respects, like programmatic flexibilities, those differences are not new in this final rule. Some parts of the programs are harmonized, and others differ, often as a result of the respective statutory frameworks. Since NHTSA and EPA began coordinating their regulations under President Obama, differences in programmatic flexibilities have meant that manufacturers have had (and will have) to plan their compliance strategies considering both the CAFE standards and the GHG standards and assure that they are in compliance with both. NHTSA is finalizing CAFE standards that increase at 8 percent per year over MYs 2024–2025 and at 10 percent per year for MY 2026 because that is what NHTSA has concluded is maximum feasible in those model years, under the EPCA factors. Auto manufacturers are extremely sophisticated companies, well able to manage compliance strategies that account for multiple regulatory programs concurrently. Past experience with these programs indicates that each manufacturer will optimize its compliance strategy around whichever standard is most binding for its fleet of vehicles. If different agencies’ standards are more binding for some companies in certain years, this does not mean that manufacturers must build *multiple* fleets of vehicles, simply that they will have to be more strategic about *how* they build their fleet. NHTSA discusses this issue in greater detail in Section VI.A of this preamble. Critically, NHTSA has concluded that it is feasible for manufacturers to meet both the EPA and the NHTSA standards.³⁹

NHTSA has also considered and accounted for California’s ZEV mandate (and its adoption by a number of other states) in developing the baseline for

this final rule, as additional legal obligations that automakers will be meeting during this time frame, and has also accounted for the Framework Agreements between California and BMW, Ford, Honda, VWA, and Volvo, as those companies have committed to meeting those Agreements. NHTSA believes that it is appropriate to include ZEV in the baseline for this final rule because EPA has granted a waiver of Clean Air Act preemption to California for its Clean Cars Program,⁴⁰ and it is appropriate for the baseline to reflect other legal obligations that automakers will be meeting during this time period. The baseline should reflect the state of the world without the CAFE standards so that the regulatory analysis can identify the distinct effects of the CAFE standards. In addition, according to information provided by California,⁴¹ there has been extensive industry overcompliance with the ZEV standards, which suggests that regardless of the waiver, many companies intend to produce ZEVs in volumes comparable to what the current ZEV mandate would require. Thus, including state ZEV mandates in the regulatory baseline for this final rule is consistent with guidance in OMB Circular A–4 directing agencies to develop analytical baselines that are as accurate as possible regarding the state of the world in the absence of the regulatory action being evaluated. However, because modeling a subnational fleet is not currently an analytical option for NHTSA, NHTSA has not expressly accounted for California GHG standards in the analysis for this final rule. Chapter 6 of the accompanying FRIA shows the estimated effects of all of these programs simultaneously.

III. Technical Foundation for Final Rule Analysis

Why does NHTSA conduct this analysis?

NHTSA is establishing revised CAFE standards for passenger cars and light trucks produced for MYs 2024–2026. NHTSA establishes CAFE standards under the Energy Policy and Conservation Act, as amended, and this final rule is undertaken pursuant to that authority. This final rule would require

³⁷ *Phoenix Hydro Corp. v. FERC*, 775 F.2d 1187, 1191 (D.C. Cir. 1985).

³⁸ *Alabama Educ. Ass’n v. Chao*, 455 F.3d 386, 392 (D.C. Cir. 2006) (quoting *Motor Vehicle Mfrs. Ass’n of U.S., Inc. v. State Farm Mut. Auto. Ins. Co.*, 463 U.S. 29, 57 (1983)); see also *Encino Motorcars, LLC v. Navarro*, 136 S. Ct. 2117, 2125 (2016)

(“Agencies are free to change their existing policies as long as they provide a reasoned explanation for the change.”) (Citations omitted).

⁴⁰ 87 FR 14332 (Mar. 14, 2022).

⁴¹ See, e.g., https://ww2.arb.ca.gov/sites/default/files/2020-01/appendix_a_minimum_zev_regulation_compliance_scenarios_formatted_ac.pdf (accessed: March 24, 2022) (stating that “Since the 2012 adoption of the ACC requirements, vehicle technology has advanced faster and developed more broadly than originally anticipated, and the assumptions used in the original rulemaking scenario no longer reflect vehicles expected in the 2018 through 2025 timeframe.”).

³⁹ This is consistent with NHTSA’s and EPA joint finding in the 2012 final rule, as discussed further in Section VI below.

CAFE stringency for both passenger cars and light trucks to increase at a rate of 8 percent, 8 percent, and 10 percent per year annually during MY 2024, MY 2025, and MY 2026, respectively.

NHTSA estimates that over the useful lives of vehicles produced prior to MY 2030, these standards would save about 60 billion gallons of gasoline and increase electricity consumption by about 180 TWh. Accounting for emissions from both vehicles and upstream energy sector processes (e.g., petroleum refining and electricity generation), NHTSA estimates that these standards would reduce greenhouse gas emissions by about 605 million metric tons of carbon dioxide (CO₂), about 730 thousand metric tons of methane (CH₄), and about 17 thousand tons of N₂O.

When NHTSA promulgates new regulations, it generally presents an analysis that estimates the impacts of such regulations, and the impacts of other regulatory alternatives. These analyses derive from statutes such as the Administrative Procedure Act (APA), National Environmental Policy Act (NEPA), Executive orders (such as E.O. 12866 and E.O. 13653), and from other administrative guidance (e.g., Office of Management Budget Circular A-4). For CAFE, the Energy Policy and Conservation Act (EPCA), as amended by the Energy Independence and Security Act (EISA), contains a variety of provisions that require NHTSA to consider certain compliance elements in certain ways and avoid considering other things, in determining maximum feasible CAFE standards. Collectively, capturing all of these requirements and guidance elements analytically means that, at least for CAFE, NHTSA presents an analysis that spans a meaningful range of regulatory alternatives, that quantifies a range of technological, economic, and environmental impacts, and that does so in a manner that accounts for EPCA's express requirements for the CAFE program (e.g., passenger cars and light trucks are regulated separately, and the standard for each fleet must be set at the maximum feasible level in each model year).

NHTSA's decision regarding the final standards is thus supported by extensive analysis of potential impacts of the regulatory alternatives under

consideration. Along with this preamble, a TSD, a FRIA, and a Final SEIS, together provide an extensive and detailed enumeration of related methods, estimates, assumptions, and results. These additional analyses can be found in the rulemaking docket for this final rule⁴² and on NHTSA's website.⁴³ NHTSA's analysis has been constructed specifically to reflect various aspects of governing law applicable to CAFE standards and has been expanded and improved in response to comments received to the prior rulemaking and to the proposal, as well as additional work conducted over the last year or two. Further improvements may be made in the future based on comments received to the proposal, which were either out of scope for this rulemaking or for which the improvements were too extensive or complex to implement in the available time, on the 2021 NAS Report,⁴⁴ and on other additional work generally previewed in these rulemaking documents. The analysis for this final rule aided NHTSA in implementing its statutory obligations, including the weighing of various considerations, by reasonably informing decision-makers about the estimated effects of choosing different regulatory alternatives.

NHTSA's analysis makes use of a range of data (i.e., observations of things that have occurred), estimates (i.e., things that may occur in the future), and models (i.e., methods for making estimates). Two examples of *data* include (1) records of actual odometer readings used to estimate annual mileage accumulation at different vehicle ages and (2) CAFE compliance data used as the foundation for the "analysis fleet" containing, among other things, production volumes and fuel economy levels of specific configurations of specific vehicle models produced for sale in the U.S. Two examples of *estimates* include (1) forecasts of future GDP growth used, with other estimates, to forecast future

vehicle sales volumes and (2) the "retail price equivalent" (RPE) factor used to estimate the ultimate cost to consumers of a given fuel-saving technology, given accompanying estimates of the technology's "direct cost," as adjusted to account for estimated "cost learning effects" (i.e., the tendency that it will cost a manufacturer less to apply a technology as the manufacturer gains more experience doing so).

NHTSA uses the CAFE Compliance and Effects Modeling System (usually shortened to the "CAFE Model") to estimate manufacturers' potential responses to new CAFE and CO₂ standards and to estimate various impacts of those responses. DOT's Volpe National Transportation Systems Center (often simply referred to as the "Volpe Center") develops, maintains, and applies the model for NHTSA. NHTSA has used the CAFE Model to perform analyses supporting every CAFE rulemaking since 2001. The 2016 rulemaking regarding heavy-duty pickup and van fuel consumption and CO₂ emissions also used the CAFE Model for analysis.

The basic design of the CAFE Model is as follows: The system first estimates how vehicle manufacturers might respond to a given regulatory scenario, and from that potential compliance solution, the system estimates what impact that response will have on fuel consumption, emissions, and economic externalities. In a highly summarized form, Figure III-1 shows the basic categories of CAFE Model procedures and the sequential flow between different stages of the modeling. The diagram does not present specific model inputs or outputs, as well as many specific procedures and model interactions. The model documentation accompanying this preamble presents these details, and Chapter 1 of the TSD contains a more detailed version of this flow diagram for readers who are interested.

BILLING CODE 4910-59-P

⁴² Docket No. NHTSA-2021-0053, which can be accessed at <https://www.regulations.gov>.

⁴³ See <https://www.nhtsa.gov/laws-regulations/corporate-average-fuel-economy>.

⁴⁴ National Academies of Sciences, Engineering, and Medicine, 2021. *Assessment of Technologies for Improving Fuel Economy of Light-Duty Vehicles—2025–2035*, Washington, DC: The

National Academies Press (hereafter, "2021 NAS Report"). Available at <https://www.nationalacademies.org/our-work/assessment-of-technologies-for-improving-fuel-economy-of-light-duty-vehicles-phase-3> (accessed: February 11, 2022) and for hard-copy review at DOT headquarters.

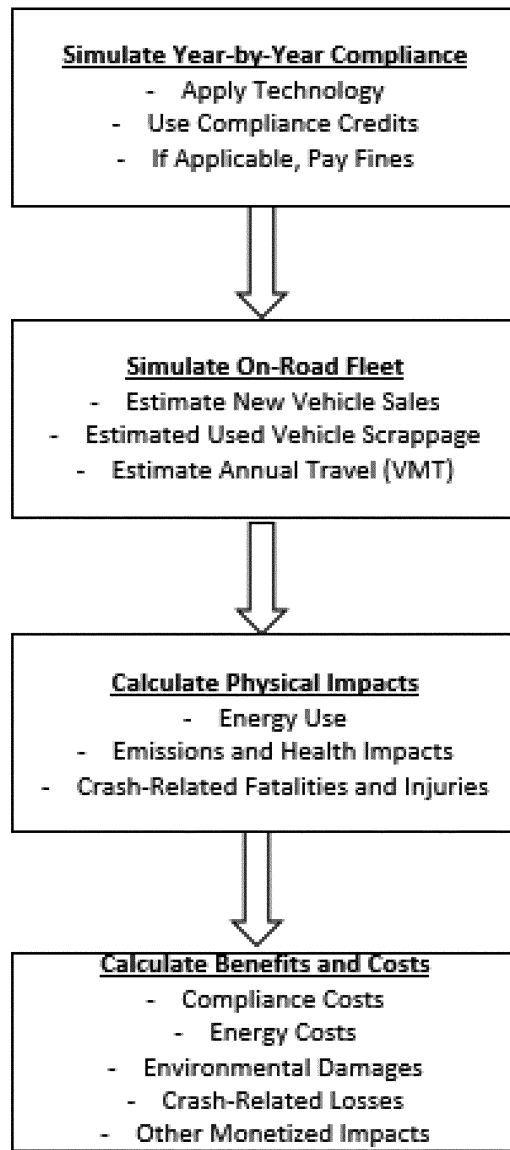

Figure III-1 – CAFE Model Procedures and Logical Flow

BILLING CODE 4910-59-C

More specifically, the model may be characterized as an integrated system of models. For example, one model estimates manufacturers' responses, another estimates resultant changes in total vehicle sales, and still another estimates resultant changes in fleet turnover (*i.e.*, scrappage). Additionally, and importantly, the model does not determine the form or stringency of the standards. Instead, the model applies inputs specifying the form and stringency of standards to be analyzed and produces outputs showing the impacts of manufacturers working to meet those standards, which become the basis for comparing between different

potential stringencies. A regulatory scenario, meanwhile, involves specification of the form, or shape, of the standards (*e.g.*, flat standards, or linear or logistic attribute-based standards), scope of passenger car and truck regulatory classes, and stringency of the CAFE standards for each model year to be analyzed. For example, a regulatory scenario may define CAFE standards that increase in stringency by a given percent per year for a given number of consecutive years.

Manufacturer compliance simulation and the ensuing effects estimation, collectively referred to as compliance modeling, encompass numerous subsidiary elements. Compliance

simulation begins with a detailed user-provided initial forecast of the vehicle models offered for sale during the simulation period.⁴⁵ The compliance simulation then attempts to bring each manufacturer into compliance with the standards defined by the regulatory

⁴⁵ Because the CAFE Model is publicly available, anyone can develop their own initial forecast (or other inputs) for the model to use. The DOT-developed Market Data file that contains the forecast used for this final rule is available on NHTSA's website at <https://www.nhtsa.gov/corporate-average-fuel-economy/cape-compliance-and-effects-modeling-systems>. (Accessed: March 22, 2022).

scenario contained within an input file developed by the user.⁴⁶

Estimating impacts involves calculating resultant changes in new vehicle costs, estimating a variety of costs (e.g., for fuel) and effects (e.g., CO₂ emissions from fuel combustion) occurring as vehicles are driven over their lifetimes before eventually being scrapped, and estimating the monetary value of these effects. Estimating impacts also involves consideration of consumer responses—e.g., the impact of vehicle fuel economy, operating costs, and vehicle price on consumer demand for passenger cars and light trucks. Both basic analytical elements involve the application of many analytical inputs. Many of these inputs are developed *outside* of the model and not *by* the model. For example, the model *applies* fuel prices; it does not *estimate* fuel prices.

NHTSA also uses EPA's MOVES model to estimate "tailpipe" (a.k.a. "vehicle" or "downstream") emission factors for criteria pollutants,⁴⁷ and uses four DOE and DOE-sponsored models to develop inputs to the CAFE Model, including three developed and maintained by DOE's Argonne National Laboratory. The agency uses the DOE Energy Information Administration's (EIA's) National Energy Modeling System (NEMS) to estimate fuel prices,⁴⁸ and uses Argonne's Greenhouse gases, Regulated Emissions, and Energy use in Transportation (GREET) model to estimate emissions rates from fuel production and distribution processes.⁴⁹ DOT also sponsored DOE/Argonne to use Argonne's Autonomie full-vehicle modeling and simulation system to estimate the fuel economy impacts for over a million combinations of technologies and vehicle types.^{50 51} The

TSD and FRIA describe details of the agency's use of these models. In addition, as discussed in the Final SEIS accompanying this final rule, DOT relied on a range of climate models to estimate impacts on climate, air quality, and public health. The Final SEIS discusses and describes the use of these models.

To prepare for analysis supporting this final rule, DOT has refined and expanded the CAFE Model through ongoing development. Examples of such changes, some informed by past external comments, made since early 2020 include:

- Inclusion of 400- and 500-mile BEVs;
- Inclusion of high compression ratio (HCR) engines with cylinder deactivation;
- Accounting for manufacturers' responses to both CAFE and CO₂ standards jointly (rather than only separately);
- Accounting for the ZEV mandates applicable in California and the "Section 177" states;
- Accounting for some vehicle manufacturers' (BMW, Ford, Honda, VW, and Volvo) voluntary agreement with the state of California to continued annual national-level reductions of vehicle greenhouse gas emissions through MY 2026, with greater rates of electrification than would have been required under the 2020 final rule;⁵²
- Inclusion of CAFE civil penalties in the "effective cost" metric used when simulating manufacturers' potential application of fuel-saving technologies;
- Refined procedures to estimate health effects and corresponding monetized damages attributable to criteria pollutant emissions;
- New procedures to estimate the impacts and corresponding monetized damages of highway vehicle crashes that do not result in fatalities;

characteristics of the simulated vehicle and its level of electrification. Information regarding Argonne's BatPaC model is available at <https://www.anl.gov/cse/batpac-model-software>. (Accessed: February 16, 2022).

⁵¹ In addition, the impact of engine technologies on fuel consumption, torque, and other metrics was characterized using GT-POWER simulation modeling in combination with other engine modeling that was conducted by IAV Automotive Engineering, Inc. (IAV). The engine characterization "maps" resulting from this analysis were used as inputs for the Autonomie full-vehicle simulation modeling. Information regarding GT-POWER is available at <https://www.gtisoft.com/gt-suite-applications/propulsion-systems/gt-power-engine-simulation-software>. (Accessed: February 16, 2022).

⁵² For more information on the Framework Agreements for Clean Cars, including the specific agreements signed by individual manufacturers, see <https://ww2.arb.ca.gov/news/framework-agreements-clean-cars>. (Accessed: February 16, 2022).

• Procedures to ensure that modeled technology application and production volumes are the same across all regulatory alternatives in the earliest model years; and

• Procedures to more precisely focus application of the EPCA's "standard setting constraints" (i.e., regarding the consideration of compliance credits and additional dedicated alternative fueled vehicles) to only those model years for which NHTSA is proposing or finalizing new standards.

These changes reflect DOT's long-standing commitment to ongoing refinement of its approach to estimating the potential impacts of new CAFE standards. Following the proposal preceding this document, NHTSA made several further changes to the CAFE Model, including:

- New options for applying a dynamic fleet share model (of the relative shares passenger cars and light trucks comprise of the total U.S. new vehicle market);
- Provisions allowing direct input of the number of miles to be included when valuing avoided fuel outlays in the models used to estimate impacts on the total sales of new vehicles and the scrappage of used vehicles;
- Expanded model output reporting to include all estimates (for this analysis) of the social cost of carbon dioxide emissions (i.e., the SCC) when reporting total and net benefits to society;
- Procedures to calculate and report the value of miles reallocated between new and used vehicles (when holding overall travel demand before accounting for the rebound effect constant between regulatory alternatives);
- Adjustments to reduce exclude finance costs from reported incremental costs to consumers, and reduce reported insurance costs by 20 percent (to prevent double-counting of the costs to replace totaled vehicles); and
- Revisions to allow direct specification of total VMT even in years for which the CAFE Model estimates new vehicle sales (in particular, for this analysis, 2021, to account for VMT recovering rapidly following the decline in the early months of the COVID-19 pandemic).

The TSD accompanying this document elaborates on these changes to the CAFE Model, as well as changes to input to the model for this analysis.

NHTSA underscores that this analysis exercises the CAFE Model in a manner that explicitly accounts for the fact that in producing a single fleet of vehicles for sale in the United States, manufacturers face the *combination* of CAFE standards, EPA CO₂ standards,

⁴⁶ With appropriate inputs, the model can also be used to estimate impacts of manufacturers' potential responses to new CO₂ standards and to California's ZEV program.

⁴⁷ See <https://www.epa.gov/moves>. This final rule uses version MOVES3, available at <https://www.epa.gov/moves/latest-version-motor-vehicle-emission-simulator-moves>. (Accessed: February 16, 2022).

⁴⁸ See <https://www.eia.gov/outlooks/archive/aeo21>. (Accessed: February 16, 2022) This final rule uses fuel prices estimated using the Annual Energy Outlook (AEO) 2021 version of NEMS (see <https://www.eia.gov/outlooks/aeo/pdf/02%20AEO2021%20Petroleum.pdf>). (Accessed: February 16, 2022).

⁴⁹ Information regarding GREET is available at <https://greet.es.anl.gov/index.php>. (Accessed: February 16, 2022) This final rule uses the 2021 version of GREET.

⁵⁰ As part of the Argonne simulation effort, individual technology combinations simulated in Autonomie were paired with Argonne's BatPaC model to estimate the battery cost associated with each technology combination based on

and ZEV mandates, and for five manufacturers, the voluntary agreement with California to more stringent GHG reduction requirements (also applicable to these manufacturers' total production for the U.S. market) through MY 2026. These regulations and contracts have important structural and other differences that affect the strategy a manufacturer could use to comply with each of the above.

As explained, the analysis is designed to reflect a number of statutory and regulatory requirements applicable to CAFE and tailpipe CO₂ standard-setting. EPCA contains a number of requirements governing the scope and nature of CAFE standard setting. Among these, some have been in place since EPCA was first signed into law in 1975, and some were added in 2007, when Congress passed EISA and amended EPCA. EPCA/EISA requirements regarding the technical characteristics of CAFE standards and the analysis thereof include, but are not limited to, the following, and the analysis reflects these requirements as summarized:

Corporate Average Standards: Section 32902 of 49 U.S.C. requires standards that apply to the average fuel economy levels achieved by each corporation's fleets of vehicles produced for sale in the U.S.⁵³ The CAFE Model calculates the CAFE and CO₂ levels of each manufacturer's fleets based on estimated production volumes and characteristics, including fuel economy levels, of distinct vehicle models that could be produced for sale in the U.S.

Separate Standards for Passenger Cars and Light Trucks: Section 32902 of 49 U.S.C. requires the Secretary of Transportation to set CAFE standards separately for passenger cars and light trucks. The CAFE Model accounts separately for passenger cars and light trucks when it analyzes CAFE or CO₂ standards, including differentiated standards and compliance.

Attribute-Based Standards: Section 32902 of 49 U.S.C. requires the Secretary of Transportation to define CAFE standards as mathematical functions expressed in terms of one or more vehicle attributes related to fuel economy. This means that for a given manufacturer's fleet of vehicles produced for sale in the U.S. in a given

regulatory class and model year, the applicable minimum CAFE requirement (*i.e.*, the numerical value of the requirement) is computed based on the applicable mathematical function, and the mix and attributes of vehicles in the manufacturer's fleet. The CAFE Model accounts for such functions and vehicle attributes explicitly.

Separately Defined Standards for Each Model Year: Section 32902 of 49 U.S.C. requires the Secretary to set CAFE standards (separately for passenger cars and light trucks⁵⁴) at the maximum feasible levels in each model year. The CAFE Model represents each model year explicitly, and accounts for the production relationships between model years.⁵⁵

Separate Compliance for Domestic and Imported Passenger Car Fleets: Section 32904 of 49 U.S.C. requires the EPA Administrator to determine CAFE compliance separately for each manufacturer's fleets of domestic passenger cars and imported passenger cars, which manufacturers must consider as they decide how to improve the fuel economy of their passenger car fleets. The CAFE Model accounts explicitly for this requirement when simulating manufacturers' potential responses to CAFE standards, and combines any given manufacturer's domestic and imported cars into a single fleet when simulating that manufacturer's potential response to CO₂ standards (because EPA does not have separate standards for domestic and imported passenger cars).

Minimum CAFE Standards for Domestic Passenger Car Fleets: Section 32902 of 49 U.S.C. requires that domestic passenger car fleets meet a minimum standard, which is calculated as 92 percent of the industry-wide average level required under the applicable attribute-based CAFE standard, as projected by the Secretary at the time the standard is promulgated. The CAFE Model accounts explicitly for this requirement for CAFE standards and sets this requirement aside for CO₂ standards.

Civil Penalties for Noncompliance: Section 32912 of 49 U.S.C. (and implementing regulations) prescribes a rate (in dollars per tenth of a mpg) at

which the Secretary is to levy civil penalties if a manufacturer fails to comply with a CAFE standard for a given fleet in a given model year, after considering available credits. Some manufacturers have historically demonstrated a willingness to pay civil penalties rather than achieving full numerical compliance across all fleets. The CAFE Model calculates civil penalties (adjusted for inflation) for CAFE shortfalls and provides means to estimate that a manufacturer might stop adding fuel-saving technologies once continuing to do so would be effectively more "expensive" (after accounting for fuel prices and buyers' willingness to pay for fuel economy) than paying civil penalties. The CAFE Model does not allow civil penalty payment as an option for CO₂ standards.

Dual-Fueled and Dedicated Alternative Fuel Vehicles: For purposes of calculating CAFE levels used to determine compliance, 49 U.S.C. 32905 and 32906 specify methods for calculating the fuel economy levels of vehicles operating on alternative fuels to gasoline or diesel through MY 2020. After MY 2020, methods for calculating alternative fuel vehicle (AFV) fuel economy are governed by regulation. The CAFE Model is able to account for these requirements explicitly for each vehicle model. However, 49 U.S.C. 32902 prohibits consideration of the fuel economy of dedicated alternative fuel vehicle (AFV) models when NHTSA determines what levels of CAFE standards are maximum feasible. The CAFE Model therefore has an option to be run in a manner that excludes the additional application of dedicated AFV technologies in model years for which maximum feasible standards are under consideration. As allowed under NEPA for analysis appearing in EISs informing decisions regarding CAFE standards, the CAFE Model can also be run without this analytical constraint. The CAFE Model does account for dual- and alternative fuel vehicles when simulating manufacturers' potential responses to CO₂ standards. For natural gas vehicles, both dedicated and dual-fueled, EPA has a multiplier of 2.0 for MY 2022.⁵⁶

⁵³ This differs from safety standards and traditional emissions standards, which apply separately to each vehicle. For example, every vehicle produced for sale in the U.S. must, on its own, meet all applicable Federal motor vehicle safety standards (FMVSS), but no vehicle produced for sale must, on its own, meet Federal fuel economy standards. Rather, each manufacturer is required to produce a mix of vehicles that, taken together, achieve an average fuel economy level no less than the applicable minimum level.

⁵⁴ Chapter 329 of title 49 of the U.S. Code uses the term "non-passenger automobiles," while NHTSA uses the term "light trucks" in its CAFE regulations. The terms' meanings are identical.

⁵⁵ For example, a new engine first applied to given vehicle model/configuration in MY 2020 will most likely be "carried forward" to MY 2021 of that same vehicle model/configuration, in order to reflect the fact that manufacturers do not apply brand-new engines to a given vehicle model every single year. The CAFE Model is designed to account for these real-world factors.

⁵⁶ That said, the CAFE Model reflects the EPA regulatory flexibilities in place when the NHTSA began work on this rulemaking to reconsider CAFE standards previously issued for MYs 2024–2026, including a multiplier of 2.0 for natural gas vehicles, both dedicated and dual-fueled, for MYs 2022–2026, although EPA's recent final rule eliminated this multiplier after MY 2022. As explained elsewhere in this preamble, the effect of this particular difference between the modeling and EPA's final requirements is not significant, given the lack of NGVs in the analysis.

ZEV Mandates: The CAFE Model can simulate manufacturers' compliance with ZEV mandates applicable in California and "Section 177"⁵⁷ states. The approach involves identifying specific vehicle model/configurations that could be replaced with PHEVs or BEVs, and immediately making these changes in each model year, before beginning to consider the potential that other technologies could be applied toward compliance with CAFE or CO₂ standards.

Creation and Use of Compliance Credits: Section 32903 of 49 U.S.C. provides that manufacturers may earn CAFE "credits" by achieving a CAFE level beyond that required of a given fleet in a given model year, and specifies how these credits may be used to offset the amount by which a different fleet falls short of its corresponding requirement. These provisions allow credits to be "carried forward" and "carried back" between model years, transferred between regulated classes (domestic passenger cars, imported passenger cars, and light trucks), and traded between manufacturers. However, credit use is also subject to specific statutory limits. For example, CAFE compliance credits can be carried forward a maximum of five model years and carried back a maximum of three model years. Also, EPCA/EISA caps the amount of credit that can be transferred between passenger car and light truck fleets and prohibits manufacturers from applying traded or transferred credits to offset a failure to achieve the applicable minimum standard for domestic passenger cars. The CAFE Model explicitly simulates manufacturers' potential use of credits carried forward from prior model years or transferred from other fleets.⁵⁸ Section 32902 of 49

⁵⁷ The term "Section 177" states refers to states which have elected to adopt California's standards in lieu of Federal requirements, as allowed under Section 177 of the CAA.

⁵⁸ The CAFE Model does not explicitly simulate the potential that manufacturers would carry CAFE or CO₂ credits back (*i.e.*, borrow) from future model years, or acquire and use CAFE compliance credits from other manufacturers. At the same time, because EPA has currently elected not to limit credit trading, the CAFE Model can be exercised in a manner that simulates unlimited (a.k.a. "perfect") CO₂ compliance credit trading throughout the industry (or, potentially, within discrete trading "blobs"). NHTSA believes there is significant uncertainty in how manufacturers may choose to employ these particular flexibilities in the future: for example, while it is reasonably foreseeable that a manufacturer who over-complies in one year may "coast" through several subsequent years relying on those credits rather than continuing to make technology improvements, it is harder to assume with confidence that manufacturers will rely on future technology investments to offset prior-year shortfalls, or whether/how manufacturers will trade

U.S.C. prohibits consideration of manufacturers' potential application of CAFE compliance credits when setting maximum feasible CAFE standards. The CAFE Model can be operated in a manner that excludes the application of CAFE credits for a given model year under consideration for standard setting. For modeling CO₂ standards, the CAFE Model does not limit transfers. Insofar as the CAFE Model can be exercised in a manner that simulates trading of CO₂ compliance credits, such simulations treat trading as unlimited.⁵⁹

Statutory Basis for Stringency: Section 32902 of 49 U.S.C. requires the Secretary to set CAFE standards at the maximum feasible levels, considering technological feasibility, economic practicability, the need of the United States to conserve energy, and the impact of other motor vehicle standards of the Government on fuel economy. EPCA/EISA authorizes the Secretary to interpret these factors, and as the Department's interpretation has evolved, NHTSA has continued to expand and refine its qualitative and quantitative analysis to account for these statutory factors. For example, one of the ways that economic practicability considerations are incorporated into the analysis is through the technology effectiveness determinations: the Autonomie simulations reflect the agency's judgment that it would not be economically practicable for a manufacturer to "split" an engine shared among many vehicle model/

credits with market competitors rather than making their own technology investments. Historically, carry-back and trading have been much less utilized than carry-forward, for a variety of reasons including higher risk and preference not to 'pay competitors to make fuel economy improvements we should be making' (to paraphrase one manufacturer), although NHTSA recognizes that carry-back and trading are used more frequently when standards increase in stringency more rapidly. Given the uncertainty just discussed, and given also the fact that the agency has yet to resolve some of the analytical challenges associated with simulating use of these flexibilities, the agency considers borrowing and trading to involve sufficient risk that it is prudent to support this final rule with analysis that sets aside the potential that manufacturers could come to depend widely on borrowing and trading. While compliance costs in real life may be somewhat different from what is modeled in this document as a result of this analytical decision, that is broadly true no matter what, and the agency does not believe that the difference would be so great that it would change the policy outcome. Furthermore, a manufacturer employing a trading strategy would presumably do so because it represents a lower-cost compliance option. Thus, the estimates derived from this modeling approach are likely to be conservative in this respect, with real-world compliance costs possibly being lower.

⁵⁹ To avoid making judgments about possible future trading activity, the model simulates trading by combining all manufacturers into a single entity, so that the most cost-effective choices are made for the fleet as a whole.

configurations into myriad versions each optimized to a single vehicle model/configuration.

National Environmental Policy Act: In addition, NEPA requires the Secretary to issue an EIS that documents the estimated impacts of regulatory alternatives under consideration. The Final SEIS accompanying this final rule documents changes in emission inventories as estimated using the CAFE Model, but also documents corresponding estimates—based on the application of other models documented in the Final SEIS, of impacts on the global climate, on tropospheric air quality, and on human health.

Other Aspects of Compliance: Beyond these statutory requirements applicable to DOT, EPA, or both are a number of specific technical characteristics of CAFE and/or CO₂ regulations that are also relevant to the construction of this analysis. For example, EPA has defined procedures for calculating average CO₂ levels, and has revised procedures for calculating CAFE levels, to reflect manufacturers' application of "off-cycle" technologies that increase fuel economy (and reduce CO₂ emissions). Although too little information is available to account for these provisions explicitly in the same way that the agency has accounted for other technologies, the CAFE Model includes and makes use of inputs reflecting the agency's expectations regarding the extent to which manufacturers may earn such credits, along with estimates of corresponding costs. Similarly, the CAFE Model includes and makes use of inputs regarding credits EPA has elected to allow manufacturers to earn toward CO₂ levels (not CAFE) based on the use of air conditioner refrigerants with lower global warming potential (GWP), or on the application of technologies to reduce refrigerant leakage. In addition, the CAFE Model accounts for EPA "multipliers" for certain alternative fueled vehicles, based on current regulatory provisions or on alternative approaches. Although these are examples of regulatory provisions that arise from the exercise of discretion rather than specific statutory mandate, they can materially impact outcomes.

Besides the updates to the model described above, any analysis of regulatory actions that will be implemented several years in the future, and whose benefits and costs accrue over decades, requires a large number of assumptions. Over such time horizons, many, if not most, of the relevant assumptions in such an analysis are inevitably uncertain. Each successive CAFE analysis seeks to update assumptions to reflect better the current

state of the world and the best current estimates of future conditions.

A number of assumptions have been updated since the 2020 final rule for this final rule, and some of these assumptions have been further updated since the proposal preceding this document. As discussed below, NHTSA has updated its “analysis fleet” from a MY 2017 reference to a MY 2020 reference, updated estimates of manufacturers’ compliance credit “holdings,” updated fuel price projections to reflect the U.S. Energy Information Administration’s (EIA’s) 2021 Annual Energy Outlook (AEO), updated projections of GDP and related macroeconomic measures, and updated projections of future highway travel. While NHTSA would have made these updates as a matter of course, we note that that the COVID–19 pandemic impacted major analytical inputs such as fuel prices, gross domestic product (GDP), vehicle production and sales, and highway travel. However, while NHTSA was able to further update forecasts of GDP and related macroeconomic measures after the 2021 proposal to reflect a more rapid economic recovery from the pandemic than anticipated in early 2021, EIA did not publish AEO 2022 early enough for NHTSA to include a correspondingly updated fuel price forecast in this analysis, so this analysis retains the fuel price forecasts from AEO 2021. E.O. 13990 required the formation of an Interagency Working Group (IWG) on the Social Cost of Greenhouse Gases and charged this body with updating estimates of the social costs of carbon, nitrous oxide, and methane. As discussed in the TSD, NHTSA has followed DOT’s determination that the values developed in the IWG’s interim guidance are the most consistent with

the best available science and economics and are the most appropriate estimates to use in the analysis of this rule. Those estimates of costs per ton of emissions (or benefits per ton of emissions reductions) are considerably greater than those applied in the analysis supporting the 2020 final rule. Even still, the estimates NHTSA is now using are not able to fully quantify and monetize a number of important categories of climate damages; because of those omitted damages and other methodological limits, DOT believes its values for SC–GHG are conservative underestimates. These and other updated analytical inputs are discussed in detail in the TSD. NHTSA addresses comments about these assumptions later in this preamble.

What is NHTSA analyzing?

As in the CAFE and CO₂ rulemakings in 2010, 2012, and 2020, NHTSA is establishing attribute-based CAFE standards defined by a mathematical function of vehicle footprint, which has observable correlation with fuel economy. EPCA, as amended by EISA, expressly requires that CAFE standards for passenger cars and light trucks be based on one or more vehicle attributes related to fuel economy and be expressed in the form of a mathematical function.⁶⁰ Thus, the final standards (and regulatory alternatives) take the form of fuel economy targets expressed as functions of vehicle footprint (the product of vehicle wheelbase and average track width) that are separate for passenger cars and light trucks. Chapter 1.2.3 of the TSD discusses in detail NHTSA’s continued reliance on footprint as the relevant attribute on which these standards are based.

Under the footprint-based standards, the function defines a fuel economy

performance target for each unique footprint combination within a car or truck model type. Using the functions, each manufacturer thus will have a CAFE average standard for each year that is almost certainly unique to each of its fleets,⁶¹ based upon the footprints and production volumes of the vehicle models produced by that manufacturer. A manufacturer will have separate footprint-based standards for cars and for trucks, consistent with 49 U.S.C. 32902(b)’s direction that NHTSA must set separate standards for cars and for trucks. The functions are mostly sloped, so that generally, larger vehicles (*i.e.*, vehicles with larger footprints) will be subject to lower mpg targets than smaller vehicles. This is because, generally speaking, smaller vehicles are more capable of achieving higher levels of fuel economy, mostly because they tend not to have to work as hard (and therefore require as much energy) to perform their driving task. Although a manufacturer’s fleet average standards could be estimated throughout the model year based on the projected production volume of its vehicle fleet (and are estimated as part of EPA’s certification process), the standards with which the manufacturer must comply are determined by its final model year production figures. A manufacturer’s calculation of its fleet average standards, as well as its fleets’ average performance at the end of the model year, will thus be based on the production-weighted average target and performance of each model in its fleet.⁶²

For passenger cars, consistent with prior rulemakings, NHTSA is defining fuel economy targets as shown in Equation III–1.

BILLING CODE 4910–59–P

$$TARGET_{FE} = \frac{1}{MIN \left[MAX \left(c \times FOOTPRINT + d, \frac{1}{a} \right), \frac{1}{b} \right]}$$

Equation III-1 – Passenger Car Fuel Economy Footprint Target Curve

Where:

$TARGET_{FE}$ is the fuel economy target (in mpg) applicable to a specific vehicle

model type with a unique footprint combination,

a is a minimum fuel economy target (in mpg),

b is a maximum fuel economy target (in mpg),

c is the slope (in gallons per mile per square foot, or gpm, per square foot) of a line relating fuel consumption (the inverse of fuel economy) to footprint, and

d is an intercept (in gpm) of the same line.

⁶⁰ 49 U.S.C. 32902(a)(3)(A).

⁶¹ EPCA/EISA requires NHTSA and EPA to separate passenger cars into domestic and import passenger car fleets for CAFE compliance purposes (49 U.S.C. 32904(b)), whereas EPA combines all

passenger cars into one fleet for GHG compliance purposes.

⁶² As discussed in prior rulemakings, a manufacturer may have some vehicle models that exceed their target and some that are below their target. Compliance with a fleet average standard is

determined by comparing the fleet average standard (based on the production-weighted average of the target levels for each model) with fleet average performance (based on the production-weighted average of the performance of each model).

Here, *MIN* and *MAX* are functions that take the minimum and maximum values, respectively, of the set of

included values. For example, *MIN*[40, 35] = 35 and *MAX*(40, 25) = 40, such that *MIN*[*MAX*(40, 25), 35] = 35.

For the Preferred Alternative, this equation is represented graphically as the curves in Figure III-2.

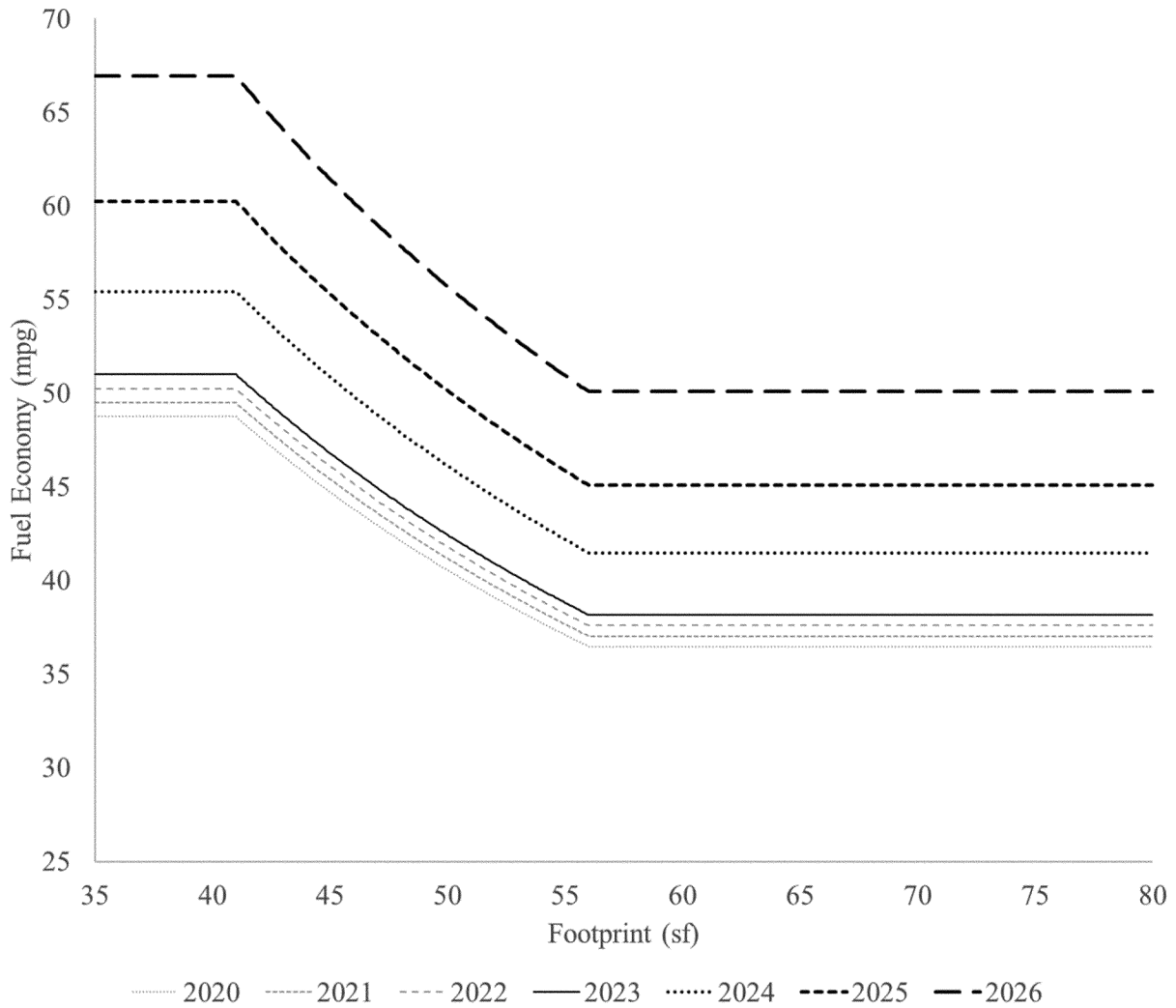

Figure III-2 – Preferred Alternative, Fuel Economy Target Curves, Passenger Cars

For light trucks, also consistent with prior rulemakings, NHTSA is defining fuel economy targets as shown in Equation III-2.

$TARGET_{FE}$

$$= MAX \left(\frac{1}{MIN \left[MAX \left(c \times FOOTPRINT + d, \frac{1}{a} \right), \frac{1}{b} \right]}, \frac{1}{MIN \left[MAX \left(g \times FOOTPRINT + h, \frac{1}{e} \right), \frac{1}{f} \right]} \right)$$

Equation III-2 – Light Truck Fuel Economy Target Curve

Where:

$TARGET_{FE}$ is the fuel economy target (in mpg) applicable to a specific vehicle model type with a unique footprint combination,

$a, b, c,$ and d are as for passenger cars, but taking values specific to light trucks,

e is a second minimum fuel economy target (in mpg),

f is a second maximum fuel economy target (in mpg),

g is the slope (in gpm per square foot) of a second line relating fuel consumption (the inverse of fuel economy) to footprint, and

h is an intercept (in gpm) of the same second line.

For the Preferred Alternative, this equation is represented graphically as the curves in Figure III-3.

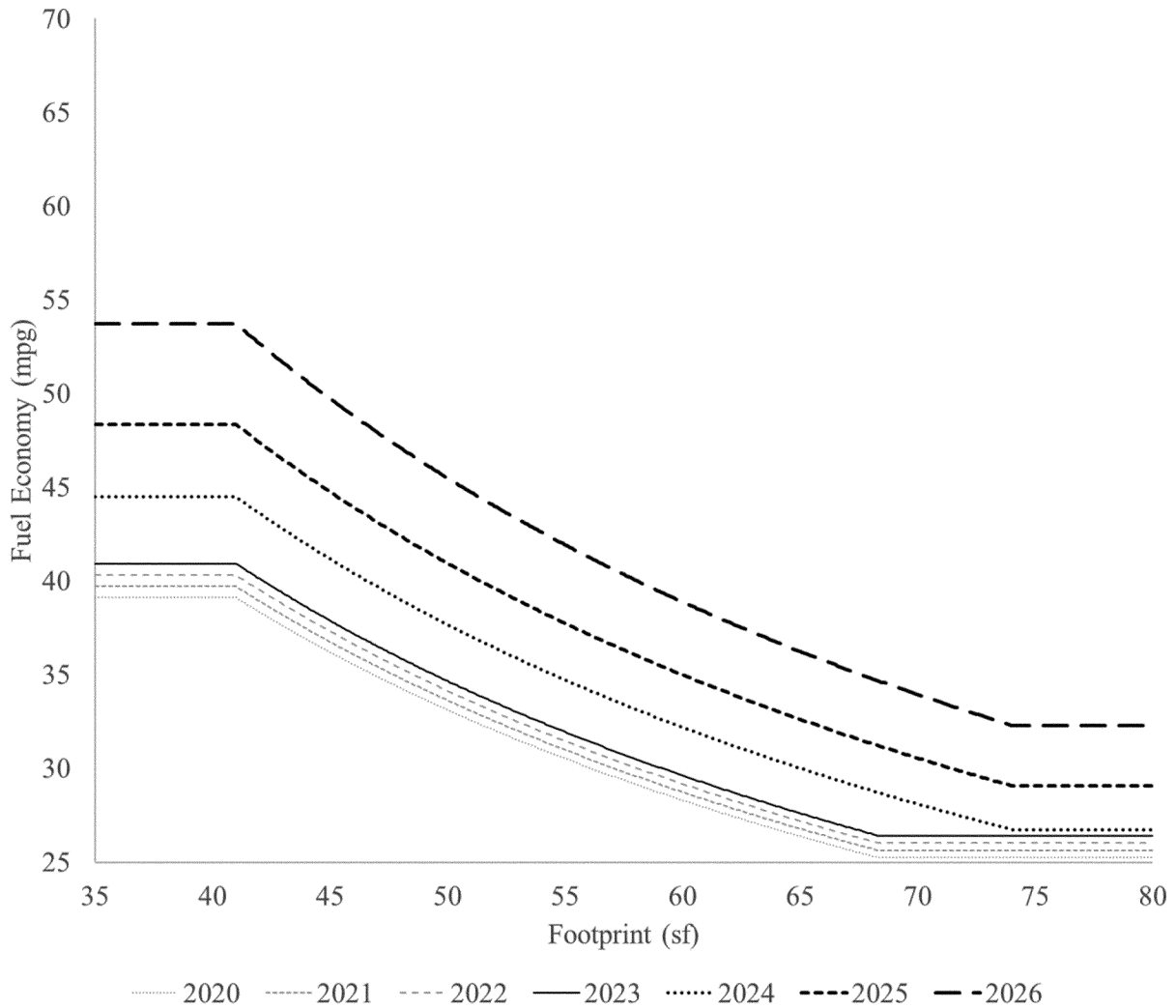

Figure III-3 – Preferred Alternative, Fuel Economy Target Curves, Light Trucks

Although the general model of the target function equation is the same for each vehicle category (passenger cars and light trucks) and each model year, the parameters of the function equation differ for cars and trucks. The actual parameters for both the Preferred Alternative and the other regulatory alternatives are presented in Section IV.B of this preamble.

As has been the case since NHTSA began establishing attribute-based standards, no vehicle need meet the specific applicable fuel economy target,

because compliance with CAFE standards is determined based on corporate average fuel economy. In this respect, CAFE standards are unlike, for example, Federal Motor Vehicle Safety Standards (FMVSS) and certain vehicle criteria pollutant emissions standards where each car must meet the requirements. CAFE standards apply to the average fuel economy levels achieved by manufacturers' entire fleets of vehicles produced for sale in the U.S. Safety standards apply on a vehicle-by-vehicle basis, such that every single

vehicle produced for sale in the U.S. must, on its own, comply with minimum FMVSS. When first mandating CAFE standards in the 1970s, Congress specified a more flexible averaging-based approach that inherently allows some vehicles to "under comply" (*i.e.*, fall short of the overall flat standard, or fall short of their target under attribute-based standards), as long as a manufacturer's overall fleet is in compliance.

The required CAFE level applicable to a given fleet in a given model year is determined by calculating the

production-weighted harmonic average of fuel economy targets applicable to

specific vehicle model configurations in the fleet, as shown in Equation III-3.

$$CAFE_{required} = \frac{\sum_i PRODUCTION_i}{\sum_i \frac{PRODUCTION_i}{TARGET_{FE,i}}}$$

Equation III-3 – Calculation for Required CAFE Level

BILLING CODE 4910-59-C

Where:

$CAFE_{required}$ is the CAFE level the fleet is required to achieve,

i refers to specific vehicle model/configurations in the fleet,

$PRODUCTION_i$ is the number of model configuration i produced for sale in the U.S., and

$TARGET_{FE,i}$ is the fuel economy target (as defined above) for model configuration i .

Chapter 1 of the TSD describes the use of attribute-based standards, generally, and explains the specific decision, in past rules and for the current rule, to continue to use vehicle footprint as the attribute over which to vary stringency. That chapter also discusses the policy in selecting the specific mathematical function; the methodologies used to develop the current attribute-based standards; and methodologies previously used to reconsider the mathematical function for CAFE standards. NHTSA refers readers to the TSD for a full discussion of these topics.

Several commenters supported the continued use of footprint as the attribute on which to base fuel economy standards. Consumer Reports,⁶³ Alliance for Automotive Innovation (Auto Innovators),⁶⁴ the Aluminum Association,⁶⁵ and National Automobile Dealers Association (NADA)⁶⁶ all agreed that footprint-based standards continue to incentivize improvements in fuel economy across all companies and across all market segments/vehicle classes. Auto Innovators pointed to the most recent EPA Trends Report as indicating that any change in average vehicle footprint has been minimal at the industry level, implying that

footprint-based standards are not leading to “gaming” by manufacturers seeking a less-stringent standard by increasing their vehicles’ footprints.⁶⁷ The Aluminum Association suggested that footprint-based standards could be beneficial for safety, because they incentivize weight reduction in larger footprint vehicles, which make up an increasing portion of the fleet.⁶⁸ NADA⁶⁹ and International Union, United Automobile, Aerospace & Agricultural Implement Workers of America (UAW)⁷⁰ both stated that footprint-based standards supported manufacturers continuing to provide a wide range of vehicles from which consumers could choose, with UAW stating that “[s]imply put, to do otherwise undermines domestic manufacturing, workers’ living standards, and communities well-being. All vehicles do not have the same function and surely our rules need to continue to reflect this reality.”⁷¹

One citizen commenter, Doug Peterson (Peter Douglas), objected to the use of footprint as the attribute on which to base fuel economy standards, stating that a consequence of using footprint is that “[w]asteful models are simply compensated for by more efficient models that outperform their footprint targets, and this will become a huge problem as more and more ZEVs enter the marketplace.”⁷² Mr. Douglas further commented that discouraging vehicle downsizing (as footprint-based standards can do) was an inappropriate policy goal, because downsizing can be a good way to reduce fuel consumption and the current upsizing trend in the fleet is not mitigated by footprint-based standards. He also commented that the safety concern that footprint-based standards can address is in fact

misplaced, because “[l]arge vehicles provide safety benefits to their occupants at the expense of people occupying small vehicles.”⁷³

NHTSA appreciates these comments but is continuing to rely on footprint as the attribute for the final standards for MYs 2024–2026. NHTSA notes that the first issue that Mr. Douglas raised is due to the fact that the standards are, by law, corporate average standards, and that “wasteful models [being] compensated for by more efficient models” is difficult to avoid when standards are corporate averages—by their nature, they enable averaging across a manufacturer’s fleet. The comments from the Aluminum Association comments, Auto Innovators, and Mr. Douglas’ further comments on the topic of footprint seem to address one another. As Auto Innovators notes, the most recent EPA Trends Report appears to suggest that, on average, vehicle upsizing has been minimal at the industry (fleet) level. While footprint may not encourage vehicle downsizing, it does reward vehicle downweighting, which NHTSA typically refers to as “mass reduction.” A lighter vehicle saves fuel compared to a heavier vehicle of the same footprint, and thus performs better against its footprint target. NHTSA addresses safety comments in Section V of this preamble.

While Chapter 1 of the TSD explains why the final standards for MYs 2024–2026 continue to be footprint-based, the question has arisen periodically of whether NHTSA should instead consider multi-attribute standards, such as those that also depend on weight, torque, power, towing capability, off-road capability, or a combination of such attributes. To date, every time NHTSA has considered options for which attribute(s) to select, the agency has concluded that a properly designed footprint-based approach provides the best means of achieving the basic policy goals (*i.e.*, by increasing the likelihood of improved fuel economy across the

⁶³ Consumer Reports, Docket No. NHTSA–2021–0053–1576–A9, at p. 7.

⁶⁴ Auto Innovators, Docket No. NHTSA–2021–0053–1492, at p. 47.

⁶⁵ The Aluminum Association (Aluminum Association), Docket No. NHTSA–2021–0053–1518, at p. 3; Arconic Corporation (Arconic), Docket No. NHTSA–2021–0053–1560, at p. 2 (Arconic, an individual aluminum producer, also supported footprint-based standards).

⁶⁶ NADA, Docket No. NHTSA–2021–0053–1471, at p. 3.

⁶⁷ Auto Innovators, at p. 48.

⁶⁸ Aluminum Association, at p. 3.

⁶⁹ NADA, at p. 3.

⁷⁰ UAW, Docket No. NHTSA–2021–0053–0931, at p. 2.

⁷¹ UAW, at p. 4.

⁷² Peter Douglas, Docket No. NHTSA–2021–0053–0085, at pp. 12–13, p. 19.

⁷³ *Id.*

entire fleet of vehicles, as noted by commenters) involved in applying an attribute-based standard. At the same time, footprint-based standards need also to be structured in a way that furthers the energy and environmental policy goals of EPCA without creating inappropriate incentives to increase vehicle size in ways that could increase fuel consumption or compromise safety. That said, as NHTSA moves forward with the CAFE program, and continues to refine our understanding of the light-duty vehicle market and trends in vehicle and highway safety, NHTSA will also continue to revisit whether other approaches (or other ways of applying the same basic approaches) could provide better means of achieving policy goals.

For example, in the 2021 NAS Report, the committee recommended that if Congress does not act to remove the prohibition at 49 U.S.C. 32902(h) on considering the fuel economy of dedicated alternative fuel vehicles (like BEVs) in determining maximum feasible CAFE standards, then NHTSA should account for the fuel economy benefits of ZEVs by “setting the standard as a function of a second attribute in addition to footprint—for example, the expected market share of ZEVs in the total U.S. fleet of new light-duty vehicles—such that the standards increase as the share of ZEVs in the total U.S. fleet increases.”⁷⁴ DOE seconded this suggestion in its comments during interagency review of the proposal. NHTSA sought comment on whether and how NHTSA might consider adding electrification as an attribute on which to base CAFE standards, and specifically on the NAS committee recommendation.

Two electric vehicle manufacturers supported the addition of electrification as an attribute on which fuel economy standards could be based. Lucid USA, Inc. (Lucid) stated that, in setting standards based on electrification as well as footprint, NHTSA should “consider the battery efficiency of the electric vehicles manufactured by each automaker, as well as the market penetration of electric vehicles in the fleet.”⁷⁵ Rivian Automotive, LLC (Rivian) stated that such “[a]pproaches . . . merit further study and eventual implementation.”⁷⁶ With regard to the timing of making such a change, a question on which NHTSA specifically sought comment, Rivian commented

that “[i]t is likely infeasible and inappropriate to implement such a change in time for any of the model years subject to this rulemaking, but Rivian believes development, review, and implementation of a newly conceived multi-attribute function could take effect in the second half of this decade, coinciding with a post-MY 2027 rule, and provide industry with appropriate lead-time given typical product development lifecycles.”⁷⁷

Other commenters disagreed with adding electrification as an attribute. Several opined that adding electrification as an attribute seemed impermissible under 49 U.S.C. 32902(h).⁷⁸ Auto Innovators argued that it could create battery supply chain risks as an unintended consequence, and that “. . . including electrification as a fuel economy attribute could be solidifying a dependence on foreign supply chains that might not be reliable or have shared interests with our country.”⁷⁹ American Honda Motor Co., Inc. (Honda)⁸⁰ and Kia Corporation (Kia)⁸¹ also raised the possibility of unintended consequences and externalities. Kia further suggested that “[i]n the same manner that the footprint curves include many of the weight, technology cost, and engineering analyses that go in to bringing these vehicles online, electrification would need to have similar considerations accounted for in the modeling assumptions,”⁸² while Honda stated that the agency should provide “more than a full product cycle (5–6 year[s]) of lead time” to give industry time to plan for any changes.⁸³ Auto Innovators commented that it could be permissible to limit consideration of electrification to HEVs, but “[t]he existing approach with footprint-based curves does not need to be modified if one simply wants to require a more efficient gasoline-powered fleet—whether through increased electrification or some other means.”⁸⁴ Jaguar Land Rover NA, LLC (JLR) offered a similar comment.⁸⁵

Stellantis commented that “the ‘percent of work’ metric as ultimately

⁷⁷ *Id.*

⁷⁸ Auto Innovators, at 48; Stellantis, Docket No. NHTSA–2021–0053–1527, at 12; NADA, at p. 4; Valero Energy Corporation (Valero), Docket No. NHTSA–2021–0053–1541, at pp. 3–4; Peter Douglas, at p. 25.

⁷⁹ Auto Innovators, at p. 50.

⁸⁰ Honda, Docket No. NHTSA–2021–0053–1501, at p. 4.

⁸¹ Kia, Docket No. NHTSA–2021–0053–1525, at p. 10.

⁸² *Id.*

⁸³ Honda, at p. 4.

⁸⁴ Auto Innovators, at p. 50.

⁸⁵ JLR, Docket No. NHTSA–2021–0053–1505, at p. 4.

applied in the proposal is a fleet level of electrification selected as a policy goal rather than an attribute of a particular vehicle (like footprint) as intended by the statute.”⁸⁶ NADA argued that “[f]leet-wide standards should be technologically neutral and set at levels that are achievable without ZEVs so as not to penalize those OEMs (and their dealers) that choose not to aggressively develop, produce, and push ZEVs to market.”⁸⁷ And finally, Securing America’s Future Energy commented that adding electrification as an attribute just makes the program more complicated, and NHTSA should be looking for ways to simplify it instead, perhaps via a legislative solution.⁸⁸

As explained above, for this final rule, NHTSA is continuing to base the MY 2024–2026 standards on footprint. NHTSA is not adding electrification as an attribute at this time, based in part on comments that raised concerns with how to implement such an approach practically, in a way that would further EPCA’s overarching goal of energy conservation, while providing industry with appropriate lead time to make changes to their fleet. NHTSA is also mindful of introducing further uncertainty to the standards during this time of rapid change in the stringency of the standards. Therefore, while NHTSA agrees with comments suggesting that the recommendation from the NAS committee merits further consideration, NHTSA also agrees with other commenters who suggested that this rulemaking is not the proper one in which to implement such a change, given the available lead time for manufacturers to adjust their compliance approaches.

C. What inputs does the compliance analysis require?

The CAFE Model applies various technologies to different vehicle models in each manufacturer’s product line to simulate how each manufacturer might make progress toward compliance with the specified standard. Subject to a variety of user-controlled constraints, the model applies technologies based on their relative cost-effectiveness, as determined by several input assumptions regarding the cost and effectiveness of each technology, the cost of compliance (determined by the change in CAFE or CO₂ credits, CAFE-related civil penalties, or value of CO₂ credits, depending on the compliance

⁸⁶ Stellantis, at p. 12.

⁸⁷ NADA, at pp. 3–4.

⁸⁸ Securing America’s Future Energy, Docket No. NHTSA–2021–0053–1513, at pp. 18–19.

⁷⁴ 2021 NAS Report, at Summary Recommendation p. 5.

⁷⁵ Lucid, Docket No. NHTSA–2021–0053–1584, at p. 5.

⁷⁶ Rivian, Docket No. NHTSA–2021–0053–1562, at p. 5.

program being evaluated), and the value of avoided fuel expenses. For a given manufacturer, the compliance simulation algorithm applies technologies either until the manufacturer runs out of cost-effective technologies,⁸⁹ until the manufacturer exhausts all available technologies, or, if the manufacturer is assumed to be willing to pay civil penalties or acquire credits from another manufacturer, until paying civil penalties or purchasing credits becomes more cost-effective than increasing vehicle fuel economy. At this stage, the system assigns an incurred technology cost and updated fuel economy to each vehicle model, as well as any civil penalties incurred/credits purchased by each manufacturer. This compliance simulation process is repeated for each model year included in the study period (through MY 2050 in this analysis).

At the conclusion of the compliance simulation for a given regulatory scenario, the system transitions between compliance simulation and effects calculations. This is the point where the system produces a full representation of the registered light-duty vehicle population in the United States. The CAFE Model then uses this fleet to generate estimates of the following (for each model year and calendar year included in the analysis): Lifetime travel, fuel consumption, carbon dioxide and criteria pollutant emissions, the magnitude of various economic externalities related to vehicular travel (*e.g.*, congestion and noise), and energy consumption (*e.g.*, the economic costs of short-term increases in petroleum prices, or social damages associated with GHG emissions). The system then uses these estimates to measure the benefits and costs associated with each regulatory alternative (relative to the No-Action Alternative).

To perform this analysis, the CAFE Model uses millions of data points contained in several input files that have been populated by engineers, economists, and safety and environmental program analysts at both NHTSA and the DOT's Volpe National Transportations Systems Center (Volpe). In addition, some of the input data come from modeling and simulation analysis performed by experts at Argonne National Laboratory using their

⁸⁹ Generally, the model considers a technology cost-effective if it pays for itself in fuel savings within a "payback period" specified as a model input (for this analysis, 30 months). Depending on the settings applied, the model can continue to apply technologies that are *not* cost-effective rather than choosing other compliance options; if it does so, it will apply those additional technologies in order of cost-effectiveness (*i.e.*, most cost-effective first).

Autonomie full vehicle simulation model and BatPaC battery cost model. Other inputs are derived from other models, such as the U.S. Energy Information Administration's (EIA's) National Energy Modeling System (NEMS), Argonne's "GREET" fuel-cycle emissions analysis model, and U.S. EPA's "MOVES" vehicle emissions analysis model. As NHTSA and Volpe are both organizations within DOT, we use DOT throughout these sections to refer to the collaborative work performed for this analysis.

This section and Section III.D describe the inputs that the compliance simulation requires, including an in-depth discussion of the technologies used in the analysis, how they are defined in the CAFE Model, how they are characterized for vehicles that already exist in the market, and how they can be applied to realistically simulate manufacturers' decisions, their effectiveness, and their cost. The inputs and analyses for the effects calculations, including economic, safety, and environmental effects, are discussed later in Sections III.C through III.H.

1. Overview of Inputs to the Analysis

As discussed above, the current analysis involves estimating four major swaths of effects. First, the analysis estimates how the application of various combinations of technologies could impact vehicles' costs and fuel economy levels (and CO₂ emission rates). Second, the analysis estimates how vehicle manufacturers might respond to standards by adding fuel-saving technologies to new vehicles. Third, the analysis estimates how changes in new vehicles might impact vehicle sales and operation. Finally, the analysis estimates how the combination of these changes might impact national-scale energy consumption, emissions, highway safety, and public health.

There are several CAFE Model input files important to the discussion of these first two steps, and these input files are discussed in detail later in this section and in Section III.D. The Market Data file contains the detailed description of the vehicle models and model configurations each manufacturer produces for sale in the United States. The file also contains a range of other inputs that, though not specific to individual vehicle models, may be specific to individual manufacturers. The Technologies file identifies about six dozen technologies to be included in the analysis, indicates when and how widely each technology can be applied to specific types of vehicles, provides most of the inputs involved in estimating what costs will be incurred,

and provides some of the inputs involved in estimating impacts on vehicle fuel consumption and weight.

The CAFE Model also makes use of databases of estimates of fuel consumption impacts and, as applicable, battery costs for different combinations of fuel-saving technologies.⁹⁰ These databases are termed the FE1 and FE2 Adjustments databases (the main database and the database specific to plug-in hybrid electric vehicles, applicable to those vehicles' operation on electricity) and the Battery Costs database. DOT developed these databases using a large set of full vehicle and accompanying battery cost model simulations developed by Argonne National Laboratory. The Argonne simulation outputs, battery costs, and other reference materials are also discussed in the following sections.⁹¹

The following discussion in this section and in Section III.D expands on the inputs used in the compliance analysis. Further detail is included in Chapters 2 and 3 of the TSD accompanying this notice, and all input values relevant to the compliance analysis can be seen in the Market Data, Technologies, fuel consumption and battery cost database files, and Argonne summary files included in the docket for this notice. As previously mentioned, other model input files underlie the effects analysis, and these are discussed in detail in Sections III.C through III.H.

2. The Market Data File

The Market Data file contains the detailed description of the vehicle models and model configurations each manufacturer produces for sale in the U.S. This snapshot of the recent light duty vehicle market, termed the analysis fleet, or baseline fleet, is the starting point for the evaluation of different stringency levels for future fuel economy standards. The analysis fleet provides a reference from which to project how manufacturers could apply additional technologies to vehicles to

⁹⁰ To be used as files provided separately from the model and loaded every time the model is executed, these databases are prohibitively large, spanning more than a million records and more than half a gigabyte. To conserve memory and speed model operation, DOT has integrated the databases into the CAFE Model executable file. When the model is run, however, the databases are extracted and placed in an accessible location on the user's disk drive.

⁹¹ The Argonne workbooks included in the docket for this notice include 10 databases that contain the outputs of the Autonomie full vehicle simulations, two summary workbooks of assumptions used for the full vehicle simulations, a data dictionary, and the lookup tables for battery costs generated using the BatPaC battery cost model.

cost-effectively improve vehicle fuel economy, in response to regulatory action and market conditions.⁹² For this analysis, the MY 2020 light duty fleet was selected as the baseline for further evaluation of the effects of different fuel economy standards. The Market Data file also contains a range of other inputs that, though not specific to individual vehicle models, may be specific to individual manufacturers.

The Market Data file is an Excel spreadsheet that contains five worksheets. Three worksheets, the Vehicles worksheet, Engines worksheet, and Transmissions worksheet, characterize the baseline fleet for this analysis. The three worksheets contain a characterization of every vehicle sold in MY 2020 and their relevant technology content, including the engines and transmissions that a manufacturer uses in its vehicle platforms and how those technologies are shared across platforms. In addition, the Vehicles worksheet includes baseline economic and safety inputs linked to each vehicle that allow the CAFE Model to estimate economic and safety impacts resulting from any simulated compliance pathway. The remaining two worksheets, the Manufacturers worksheet and Credits and Adjustments worksheet, include baseline compliance positions for each manufacturer, including each manufacturer's starting CAFE credit banks and whether the manufacturer is willing to pay civil penalties for

⁹² The CAFE Model does not generate compliance paths a manufacturer should, must, or will deploy. It is intended as a tool to demonstrate a compliance pathway a manufacturer *could* choose. It is almost certain all manufacturers will make compliance choices differing from those projected by the CAFE Model.

noncompliance with CAFE standards, among other inputs.

New inputs have been added for this analysis in the Vehicles worksheet and Manufacturers worksheet. The new inputs indicate which vehicles a manufacturer may reasonably be expected to convert to a zero emissions vehicle (ZEV) at first redesign opportunity, to comply with several states' ZEV program provisions. The new inputs also indicate if a manufacturer has entered into an agreement with California to achieve more stringent GHG emissions reductions targets than those promulgated in the 2020 final rule.

The following sections discuss how we built the Market Data file, including characterizing vehicles sold in MY 2020 and their technology content, and baseline safety, economic, and manufacturer compliance positions. A detailed discussion of the Market Data file development process is in TSD Chapter 2.2.

(a) Characterizing Vehicles and Their Technology Content

The Market Data file integrates information from many sources, including manufacturer compliance submissions, publicly available information, and confidential business information. At times, DOT must populate inputs using analyst judgment, either because information is still incomplete or confidential, or because the information does not yet exist.⁹³ For this analysis DOT uses mid-MY 2020 compliance data as the basis of the analysis fleet. The compliance data are supplemented for each vehicle nameplate with manufacturer

⁹³ Forward looking refresh/redesign cycles are one example of when analyst judgement is necessary.

specification sheets, usually from the manufacturer media website, or from online marketing brochures.⁹⁴ For additional information about how specification sheets inform MY 2020 vehicle technology assignments, see the technology specific assignments sections in Section III.D.

DOT uses the mid-MY 2020 compliance data to create a row on the Vehicles worksheet in the Market Data file for each vehicle (or vehicle variant⁹⁵) that lists a certification fuel economy, sales volume, regulatory class, and footprint. DOT identifies which combination of modeled technologies reasonably represents the fuel saving technologies already on each vehicle, and assigns those technologies to each vehicle, either on the Vehicles worksheet, the Engines worksheet, or the Transmissions worksheet. The fuel saving technologies considered in this analysis are listed in Table III-1.

BILLING CODE 4910-59-P

⁹⁴ The catalogue of reference specification sheets (broken down by manufacturer, by nameplate) used to populate information in the Market Data file is available in the docket.

⁹⁵ The Market Data file often includes a few rows for vehicles that may have identical certification fuel economies, regulatory classes, and footprints (with compliance sales volumes divided out among rows), because other pieces of information used in the CAFE Model may be dissimilar. For instance, in the reference materials used to create the Market Data file, for a nameplate curb weight may vary by trim level (with premium trim levels often weighing more on account of additional equipment on the vehicle), or a manufacturer may provide consumers the option to purchase a larger fuel tank size for their vehicle. These pieces of information may not impact the observed compliance position directly, but curb weight (in relation to other vehicle attributes) is important to assess mass reduction technology already used on the vehicle, and fuel tank size is directly relevant to saving time at the gas pump, which the CAFE Model uses when calculating the value of avoided time spent refueling.

Table III-1 – Fuel Saving Technologies that the CAFE Model May Apply

Technology Name	Abbreviation	Market Data File Worksheet	Technology Group
Electric Power Steering	EPS	Vehicles	Additional technologies
Improved Accessory Devices	IACC	Vehicles	Additional technologies
Start-Stop system	12VSS	Vehicles	Electrification
Belt Integrated Starter Generator	BISG	Vehicles	Electrification
Strong Hybrid Electric Vehicle, Parallel	SHEVP2	Vehicles	Electrification
Strong Hybrid Electric Vehicle, Power Split with Atkinson Engine	SHEVPS	Vehicles	Electrification
Strong Hybrid Electric Vehicle, Parallel with HCR0 Engine (Alternative path for Turbo Engine Vehicles)	P2HCR0	Vehicles	Electrification
Strong Hybrid Electric Vehicle, Parallel with HCR1 Engine (Alternative path for Turbo Engine Vehicles)	P2HCR1	Vehicles	Electrification
Strong Hybrid Electric Vehicle, Parallel with HCR1D Engine (Alternative path for Turbo Engine Vehicles)	P2HCR1D	Vehicles	Electrification

Technology Name	Abbreviation	Market Data File Worksheet	Technology Group
Strong Hybrid Electric Vehicle, Parallel with HCR2 Engine (Alternative path for Turbo Engine Vehicles)	P2HCR2	Vehicles	Electrification
Plug-in Hybrid Vehicle with Atkinson Engine and 20 miles of electric range	PHEV20	Vehicles	Electrification
Plug-in Hybrid Vehicle with Atkinson Engine and 50 miles of electric range	PHEV50	Vehicles	Electrification
Plug-in Hybrid Vehicle with TURBO1 Engine and 20 miles of electric range	PHEV20T	Vehicles	Electrification
Plug-in Hybrid Vehicle with TURBO1 Engine and 50 miles of electric range	PHEV50T	Vehicles	Electrification
Plug-in Hybrid Vehicle with Atkinson Engine and 20 miles of electric range (Alternative path for Turbo Engine Vehicles)	PHEV20H	Vehicles	Electrification
Plug-in Hybrid Vehicle with Atkinson Engine and 50 miles of electric range (Alternative path for Turbo Engine Vehicles)	PHEV50H	Vehicles	Electrification
Battery Electric Vehicle with 200 miles of range	BEV200	Vehicles	Electrification
Battery Electric Vehicle with 300 miles of range	BEV300	Vehicles	Electrification
Battery Electric Vehicle with 400 miles of range	BEV400	Vehicles	Electrification
Battery Electric Vehicle with 500 miles of range	BEV500	Vehicles	Electrification
Fuel Cell Vehicle	FCV	Vehicles	Electrification
Low Drag Brakes	LDB	Vehicles	Additional technologies
Secondary Axle Disconnect	SAX	Vehicles	Additional technologies
Baseline Tire Rolling Resistance	ROLL0	Vehicles	Rolling Resistance
Tire Rolling Resistance, 10% Improvement	ROLL10	Vehicles	Rolling Resistance
Tire Rolling Resistance, 20% Improvement	ROLL20	Vehicles	Rolling Resistance
Baseline Aerodynamic Drag Technology	AERO0	Vehicles	Aerodynamic Drag
Aerodynamic Drag, 5% Drag Coefficient Reduction	AERO5	Vehicles	Aerodynamic Drag
Aerodynamic Drag, 10% Drag Coefficient Reduction	AERO10	Vehicles	Aerodynamic Drag
Aerodynamic Drag, 15% Drag Coefficient Reduction	AERO15	Vehicles	Aerodynamic Drag
Aerodynamic Drag, 20% Drag Coefficient Reduction	AERO20	Vehicles	Aerodynamic Drag
Baseline Mass Reduction Technology	MR0	Vehicles	Mass Reduction
Mass Reduction – 5.0% of Glider	MR1	Vehicles	Mass Reduction

Technology Name	Abbreviation	Market Data File Worksheet	Technology Group
Mass Reduction – 7.5% of Glider	MR2	Vehicles	Mass Reduction
Mass Reduction – 10.0% of Glider	MR3	Vehicles	Mass Reduction
Mass Reduction – 15.0% of Glider	MR4	Vehicles	Mass Reduction
Mass Reduction – 20.0% of Glider	MR5	Vehicles	Mass Reduction
Mass Reduction – 28.2% of Glider	MR6	Vehicles	Mass Reduction
Single Overhead Cam	SOHC	Engines	Basic Engines
Dual Overhead Cam	DOHC	Engines	Basic Engines
Engine Friction Reduction	EFR	Engines	Engine Improvements
Variable Valve Timing	VVT	Engines	Basic Engines
Variable Valve Lift	VVL	Engines	Basic Engines
Stoichiometric Gasoline Direct Injection	SGDI	Engines	Basic Engines
Cylinder Deactivation	DEAC	Engines	Basic Engines
Turbocharged Engine	TURBO1	Engines	Advanced Engines
Advanced Turbocharged Engine	TURBO2	Engines	Advanced Engines
Turbocharged Engine with Cooled Exhaust Gas Recirculation	CEGR1	Engines	Advanced Engines
Advanced Cylinder Deactivation	ADEAC	Engines	Advanced Engines
High Compression Ratio Engine (Atkinson Cycle)	HCR0	Engines	Advanced Engines
Advanced High Compression Ratio Engine (Atkinson Cycle)	HCR1	Engines	Advanced Engines
Advanced High Compression Ratio Engine (Atkinson Cycle) with Cylinder Deactivation	HCR1D	Engines	Advanced Engines
EPA, 2016 Vintage Characterization High Compression Ratio Engine (Atkinson Cycle), with Cylinder Deactivation	HCR2	Engines	Advanced Engines
Variable Compression Ratio Engine	VCR	Engines	Advanced Engines
Variable Turbo Geometry Engine	VTG	Engines	Advanced Engines
Variable Turbo Geometry Engine with eBooster	VTGE	Engines	Advanced Engines
Turbocharged Engine with Cylinder Deactivation	TURBOD	Engines	Advanced Engines
Turbocharged Engine with Advanced Cylinder Deactivation	TURBOAD	Engines	Advanced Engines
Advanced Diesel Engine	ADSL	Engines	Advanced Engines
Advanced Diesel Engine with Improvements	DSLII	Engines	Advanced Engines
Advanced Diesel Engine with Improvements and Advanced Cylinder Deactivation	DSLIIAD	Engines	Advanced Engines
Compressed Natural Gas Engine	CNG	Engines	Advanced Engines

For additional information on the characterization of these technologies (including the cost, prevalence in the 2020 fleet, effectiveness estimates, and considerations for their adoption) see the appropriate technology section in Section III.D or TSD Chapter 3.

DOT also assigns each vehicle a technology class. The CAFE Model uses the technology class (and engine class, discussed below) in the Market Data file to reference the most relevant technology costs for each vehicle, and fuel saving technology combinations. We assign each vehicle in the fleet a technology class using a two-step algorithm that takes into account key characteristics of vehicles in the fleet compared to the baseline characteristics of each technology class.⁹⁶ As discussed further in Section III.C.4.b), there are ten technology classes used in the CAFE analysis that span five vehicle types and two performance variants. The technology class algorithm and assignment process is discussed in more detail in TSD Chapter 2.4.2.

We also assign each vehicle an engine technology class so that the CAFE Model can reference the powertrain costs in the Technologies file that most reasonably align with the observed vehicle. DOT assigns engine technology classes for all vehicles, including electric vehicles. If an electric powertrain replaces an internal combustion engine, the electric motor specifications may be different (and hence costs may be different) depending on the capabilities of the internal combustion engine it is replacing, and the costs in the technologies file (on the engine tab) account for the power output and capability of the gasoline or electric drivetrain.

Parts sharing helps manufacturers achieve economies of scale, deploy capital efficiently, and make the most of shared research and development expenses, while still presenting a wide array of consumer choices to the market. The CAFE Model simulates part sharing by implementing shared engines, shared transmissions, and shared mass reduction platforms. Vehicles sharing a part (as recognized in the CAFE Model), will adopt fuel saving technologies affecting that part together. To account for parts sharing across products, vehicle model/configurations that share engines are assigned the same engine

code,⁹⁷ vehicle model/configurations that share transmissions have the same transmission code, and vehicles that adopt mass reduction technologies together share the same platform. For more information about engine codes, transmission codes, and mass reduction platforms see TSD Chapter 3.

Manufacturers often introduce fuel saving technologies at a major redesign of their product or adopt technologies at minor refreshes in between major product redesigns. To support the CAFE Model accounting for new fuel saving technology introduction as it relates to product lifecycle, the Market Data file includes a projection of redesign and refresh years for each vehicle. DOT projects future redesign years and refresh years based on the historical cadence of that vehicle's product lifecycle. For new nameplates, DOT considers the manufacturer's treatment of product lifecycles for past products in similar market segments. When considering year-by-year analysis of standards, the sizing of redesign and refresh intervals will affect projected compliance pathways and how quickly manufacturers can respond to standards. TSD Chapter 2.2.1.7 includes additional information about the product design cycles assumed for this action based on historical manufacturer product design cycles.

The Market Data file also includes information about air conditioning (AC) and off-cycle technologies, but the information is not currently broken out at a row level, vehicle by vehicle.⁹⁸ Instead, historical data (and forecast projections, which are used for analysis regardless of regulatory scenario) are listed by manufacturer, by fleet on the Credits and Adjustments worksheet of the Market Data file. Section III.D.8 shows model inputs specifying estimated adjustments (all in grams/mile) for improvements to air conditioner efficiency and other off-cycle energy consumption, and for reduced leakage of air conditioner refrigerants with high global warming potential (GWP). DOT estimated future values based on an expectation that

⁹⁷ Engines (or transmissions) may not be exactly identical, as specifications or vehicle integration features may be different. However, the architectures are similar enough that it is likely the powertrain systems share R&D, tooling, and production resources in a meaningful way.

⁹⁸ Regulatory provisions regarding off-cycle technologies are new, and manufacturers have only recently begun including related detailed information in compliance reporting data. For this analysis, though, such information was not sufficiently complete to support a detailed representation of the application of off-cycle technology to specific vehicle model/configurations in the MY 2020 fleet.

manufacturers already relying heavily on these adjustments would continue do so, and that other manufacturers would, over time, also approach the limits on adjustments allowed for such improvements.

(b) Characterizing Baseline Safety, Economic, and Compliance Positions

In addition to characterizing vehicles and their technology content, the Market Data file contains a range of other inputs that, though not specific to individual vehicle models, may be specific to individual manufacturers, or that characterize baseline safety or economic information.

First, the CAFE Model considers the potential safety effect of mass reduction technologies and crash compatibility of different vehicle types. Mass reduction technologies lower the vehicle's curb weight, which may improve crash compatibility and safety, or not, depending on the type of vehicle. DOT assigns each vehicle in the Market Data file a safety class that best aligns with the mass-size-safety analysis. This analysis is discussed in more detail in Section III.H of this action and TSD Chapter 7.

The CAFE Model also includes procedures to consider the direct labor impacts of manufacturer's response to CAFE regulations, considering the assembly location of vehicles, engines, and transmissions, the percent U.S. content (that reflects percent U.S. and Canada content),⁹⁹ and the dealership employment associated with new vehicle sales. The Market Data file therefore includes baseline labor information, by vehicle. Sales volumes also influence total estimated direct labor projections in the analysis.

We hold the percent U.S. content constant for each vehicle row for the duration of the analysis. In practice, this may not be the case. Changes to trade policy and tariff policy may affect percent U.S. content in the future. Also, some technologies may be more or less likely to be produced in the U.S., and if that is the case, their adoption could affect future U.S. content. NHTSA does not have data at this time to support varying the percent U.S. content.

We also hold the labor hours projected in the Market Data file per unit transacted at dealerships, per unit produced for final assembly, per unit produced for engine assembly, and per unit produced for transmission assembly constant for the duration of the analysis, and project that the origin

⁹⁶ Baseline 0 to 60 mph accelerations times are assumed for each technology class as part of the Autonomie full vehicle simulations. DOT calculates class baseline curb weights and footprints by averaging the curb weights and footprints of vehicles within each technology class as assigned in previous analyses.

⁹⁹ Percent U.S. content was informed by the 2020 Part 583 American Automobile Labeling Act Reports, appearing on NHTSA's website.

of these activities to remain unchanged. In practice, it is reasonable to expect that plants could move locations, or engine and transmission technologies are replaced by another fuel saving technology (like electric motors and fixed gear boxes) that could require a meaningfully different amount of

assembly labor hours. NHTSA does not have data at this time to support varying labor hours projected in the Market Data file, but we will continue to explore methods to estimate the direct labor impacts of manufacturer's responses to CAFE standards in future analyses.

As observed from Table III-2, manufacturers employ U.S. labor with varying intensity. In many cases, vehicles certifying in the light truck (LT) regulatory class have a larger percent U.S. content than vehicles certifying in the passenger car (PC) regulatory class.

BILLING CODE 4910-59-P

Table III-2 – Sales Weighted Percent U.S. Content by Manufacturer, by Regulatory Class

Manufacturer	PC	LT	Total MY 2020 Sales Weighted Percent U.S. Content	Portion of Vehicles Assembled in the U.S.	Portion of Engines Assembled in the U.S.	Portion of Transmissions Assembled in the U.S.
BMW	7.1%	29.3%	15.4%	42.4%	0.0%	0.0%
Daimler	19.1%	36.2%	28.1%	41.2%	39.8%	0.0%
FCA	47.7%	52.9%	52.2%	68.0%	41.3%	45.7%
Ford	35.2%	47.5%	44.2%	83.4%	32.9%	88.5%
GM	39.8%	47.0%	44.7%	68.3%	69.8%	86.1%
Honda	55.8%	61.7%	58.3%	74.9%	85.9%	58.6%
Hyundai Kia-H	21.8%	0.0%	19.4%	46.0%	46.0%	34.3%
Hyundai Kia-K	12.8%	33.3%	20.7%	38.4%	17.2%	37.8%
JLR	2.6%	6.3%	6.2%	0.0%	0.0%	31.7%
Mazda	1.1%	1.1%	1.1%	0.0%	0.0%	0.0%
Mitsubishi	0.0%	0.3%	0.2%	0.0%	0.0%	0.0%
Nissan	29.0%	32.6%	30.1%	49.9%	47.5%	0.0%
Subaru	35.5%	22.9%	25.6%	53.2%	0.0%	0.0%
Tesla ¹⁰⁰	50.6%	50.0%	50.6%	100.0%	100.0%	100.0%
Toyota	35.2%	42.7%	38.7%	42.4%	46.0%	19.4%
Volvo	10.2%	1.1%	3.4%	12.4%	0.0%	0.0%
VWA	10.3%	8.8%	9.4%	13.5%	0.0%	0.0%
TOTAL	32.4%	41.2%	37.4%	57.1%	44.1%	44.1%

BILLING CODE 4910-59-C

Next, manufacturers may over-comply with CAFE standards and bank so-called over compliance credits. As discussed further in Section III.C.7, manufacturers may use these credits later, sell them to other manufacturers, or let them expire. The CAFE Model does not explicitly trade credits between and among

¹⁰⁰ Tesla does not have internal combustion engines, or multi-speed transmissions, even though they are identified as producing engine and transmission systems in the United States in the Market Data file.

manufacturers, but staff have adjusted starting credit banks in the Market Data file to reflect trades that are likely to happen when the simulation begins (in MY 2020). Considering information manufacturers have reported regarding compliance credits, and considering recent manufacturers' compliance positions, DOT estimates manufacturers' potential use of compliance credits in earlier model years. This aligns to an extent that represents how manufacturers could deplete their credit banks rather than producing high

volume vehicles with fuel saving technologies in earlier model years. This also avoids the unrealistic application of technologies for manufacturers in early analysis years that typically rely on credits. For a complete discussion about how these data are collected and assigned in the Market Data file, see TSD Chapter 2.2.2.3.

The Market Data file also includes assumptions about a vehicle manufacturer's preferences towards civil penalty payments. EPCA requires that if a manufacturer does not achieve

compliance with a CAFE standard in a given model year and cannot apply credits sufficient to cover the compliance shortfall, the manufacturer must pay civil penalties (*i.e.*, fines) to the Federal Government. If inputs indicate that a manufacturer treats civil penalty payment as an economic choice (*i.e.*, one to be taken if doing so would be economically preferable to applying further technology toward compliance), the CAFE Model, when evaluating the manufacturer's response to CAFE standards in a given model year, will apply fuel-saving technology only up to the point beyond which doing so would be more expensive (after subtracting the value of avoided fuel outlays) than paying civil penalties.

For this analysis, DOT exercises the CAFE Model with inputs treating all manufacturers as treating civil penalty payment as an economic choice through MY 2023. While DOT expects that only manufacturers with some history of paying civil penalties would actually treat civil penalty payment as an acceptable option, the CAFE Model does not currently simulate compliance credit trading between manufacturers, and DOT expects that this treatment of civil penalty payment will serve as a reasonable proxy for compliance credit purchases some manufacturers might actually make through MY 2023. These input assumptions for model years through 2023 reduce the potential that the model will overestimate technology application in the model years leading up to those for which the agency is finalizing new standards. As in past CAFE rulemaking analyses (except that supporting the 2020 final rule), DOT has treated manufacturers with some history of civil penalty payment (*i.e.*, BMW, Daimler, FCA, Jaguar-Land Rover, Volvo, and Volkswagen) as continuing to treat civil penalty payment as an acceptable option beyond MY 2023, but has treated all other manufacturers as unwilling to do so beyond MY 2023. DOT believes it is more accurate, as in past analyses besides the 2020 final rule, to reflect the possibility that these historical payers of civil penalties may continue to do so in the future.

Next, the CAFE Model uses an "effective cost" metric to evaluate options to apply specific technologies to specific engines, transmissions, and vehicle model configurations. Expressed on a \$/gallon basis, the analysis computes this metric by subtracting the estimated values of avoided fuel outlays and civil penalties from the corresponding technology costs, and then dividing the result by the quantity of avoided fuel consumption. The analysis computes the value of fuel

outlays over a "payback period" representing the manufacturer's expectation that the market will be willing to pay for some portion of fuel savings achieved through higher fuel economy. Once the model has applied enough technology to a manufacturer's fleet to achieve compliance with CAFE standards (and CO₂ standards and ZEV mandates) in a given model year, the model will apply any further fuel economy improvements estimated to produce a negative effective cost (*i.e.*, any technology applications for which avoided fuel outlays during the payback period are larger than the corresponding technology costs). As discussed above in Section III.A and below in Section III.C, DOT anticipates that manufacturers are likely to act as if the market is willing to pay for avoided fuel outlays expected during the first 30 months of vehicle operation.

In addition, the Market Data file includes two new sets of inputs for this analysis. In 2020, five vehicle manufacturers reached a voluntary commitment with the state of California to improve the emissions levels of their future nationwide fleets above levels required by the 2020 final rule. For this analysis, compliance with this agreement is in the baseline case for designated manufacturers. The Market Data file contains inputs indicating whether each manufacturer has committed to exceed Federal requirements per this agreement.

Finally, when considering other standards that may affect fuel economy compliance pathways, DOT includes projected zero emissions vehicles (ZEV) that would be required for manufacturers to meet standards in California and Section 177 states, per the waiver granted under the Clean Air Act. To support the inclusion of the ZEV program in the analysis, DOT identifies specific vehicle model/configurations that could adopt BEV technology in response to the ZEV program, independent of CAFE standards, at the first redesign opportunity. These ZEVs are identified in the Market Data file as future BEV200s, BEV300s, or BEV400s. Not all announced BEV nameplates appear in the MY 2020 Market Data file; in these cases, in consultation with CARB, DOT used the volume from a comparable vehicle in the manufacturer's Market Data file portfolio as a proxy. The Market Data file also includes information about the portion of each manufacturer's sales that occur in California and Section 177 states, which is helpful for determining how many ZEV credits each manufacturer will need to generate in the future to comply

with the ZEV program with their own portfolio in the rulemaking timeframe. These new procedures are described in detail below and in TSD Chapter 2.3.

3. Simulating the Zero Emissions Vehicle Program

California's Zero Emissions Vehicle (ZEV) program is one part of a program of coordinated standards that the California Air Resources Board (CARB) has enacted to control emissions of criteria pollutants and greenhouse gas emissions from vehicles. The program began in 1990 with the low-emission vehicle (LEV) regulation,¹⁰¹ and has since expanded to include eleven other states.^{102 103} These states may be referred to as Section 177 states, in reference to Section 177 of the Clean Air Act's grant of authority to allow these states to adopt California's air quality standards,¹⁰⁴ but it is important to note that not all Section 177 states have adopted the ZEV program component.¹⁰⁵ In the following discussion of the incorporation of the ZEV program into the CAFE Model, any reference to the Section 177 states refers to those states that have adopted California's ZEV program requirements.

In their comments on the NPRM, Rivian stated that our ZEV program modeling should include Minnesota, Virginia, and Nevada as ZEV states, as those states have recently adopted the

¹⁰¹ California Air Resource Board (CARB), Zero-Emission Vehicle Program. California Air Resources Board. <https://ww2.arb.ca.gov/our-work/programs/zero-emission-vehicle-program/about>. (Accessed: February 16, 2022)

¹⁰² Through 2020, the Section 177 states that had adopted the ZEV program included Colorado, Connecticut, Maine, Maryland, Massachusetts, New Jersey, New York, Oregon, Rhode Island, Vermont, and Washington. See Vermont Department of Environmental Conservation, Zero Emission Vehicles. <https://dec.vermont.gov/air-quality/mobile-sources/zev>. (Accessed: February 16, 2022)

¹⁰³ The states of Minnesota, Nevada, and Virginia have recently adopted ZEV standards, which will go into effect for MY 2025. As discussed in this section, reflecting these three states' adoption of ZEV mandates would have only negligibly impacted the agency's national-scale modeling. See Green Car Reports, Minnesota adopts California EV mandate, https://www.greencarreports.com/news/1133027_minnesota-adopts-california-ev-mandate-makes-it-tougher-for-plug-in-compliance-cars (accessed: February 16, 2022); State of Nevada Climate Initiative, Adopt Low-and Zero-Emissions Passenger Vehicle Standards, <https://climateaction.nv.gov/policies/lev-zev> (accessed: February 16, 2022); Green Car Reports, Virginia becomes 15th Clean Cars State, <https://www.greencarcongress.com/2021/03/20210330-virginia.html> (accessed: February 16, 2022).

¹⁰⁴ Section 177 of the Clean Air Act allows other states to adopt California's new motor vehicle emission standards, if specified criteria are met.

¹⁰⁵ At the time of writing, Delaware and Pennsylvania are the two states that have adopted the LEV standards, but not the ZEV portion.

regulation.¹⁰⁶ We have not included those states as part of the ZEV program in the modeling, but have ascertained that reflecting these three states' adoption of ZEV mandates would have only negligibly impacted the agency's national-scale modeling. Furthermore, the ZEV standards for these states go into effect only beginning in MY 2025, which created an inconsistency with our current modeling approach.

To account for the ZEV program, and particularly as other states have recently adopted California's ZEV standards, DOT includes the main provisions of the ZEV program in the CAFE Model's analysis of compliance pathways. As explained below, incorporating the ZEV program into the model includes converting vehicles that have been identified as potential ZEV candidates into battery-electric vehicles (BEVs) at the first redesign opportunity, so that a manufacturer's fleet meets calculated ZEV credit requirements. Since ZEV program compliance pathways happen independently from the adoption of fuel saving technology in response to increasing CAFE standards, the ZEV program is considered in the baseline of the analysis, and in all other regulatory alternatives.

Through its ZEV program, California requires that all manufacturers that sell cars within the state meet ZEV credit standards. The current credit requirements are calculated based on manufacturers' California sales volumes. Manufacturers primarily earn ZEV credits through the production of BEVs, fuel cell vehicles (FCVs), and transitional zero-emissions vehicles (TZEVs), which are vehicles with partial electrification, namely plug-in hybrids (PHEVs). Total credits are calculated by multiplying the credit value each ZEV receives by the vehicle's volume.

The ZEV and PHEV/TZEV credit value per vehicle is calculated based on the vehicle's range; ZEVs may earn up to four credits each and PHEVs with a US06 all-electric range capability of 10 mi or higher receive an additional 0.2 credits on top of the credits received based on all-electric range.¹⁰⁷ The maximum PHEV credit amount available per vehicle is 1.10.¹⁰⁸ Note however that CARB only allows intermediate-volume manufacturers to

meet their ZEV credit requirements through PHEV production.¹⁰⁹

DOT's method for simulating the ZEV program involves several steps; first, DOT calculates an approximate ZEV credit target for each manufacturer based on the manufacturer's national sales volumes, share of sales in Section 177 states, and the CARB credit requirements. Next, DOT identifies a general pathway to compliance that involves accounting for manufacturers' potential use of ZEV overcompliance credits or other credit mechanisms, and the likelihood that manufacturers would choose to comply with the requirements with BEVs rather than PHEVs or other types of compliant vehicles, in addition to other factors. For this analysis, as discussed further below, DOT consulted with CARB to determine reasonable assumptions for this compliance pathway. Finally, DOT identifies vehicles in the MY 2020 analysis fleet that manufacturers could reasonably adapt to comply with the ZEV standards at the first opportunity for vehicle redesign, based on publicly announced product plans and other information. Each of these steps is discussed in turn, below, and a more detailed description of DOT's simulation of the ZEV program is included in TSD Chapter 2.3.

The CAFE Model is designed to present outcomes at a national scale, so the ZEV analysis considers the Section 177 states as a group as opposed to estimating each state's ZEV credit requirements individually. To capture the appropriate volumes subject to the ZEV requirement, DOT calculates each manufacturer's total market share in Section 177 states. DOT also calculates the overall market share of ZEVs in Section 177 states, in order to estimate as closely as possible, the number of predicted ZEVs we expect all manufacturers to sell in those states. These shares are then used to scale down national-level information in the CAFE Model to ensure that we represent only Section 177 states in the final calculation of ZEV credits that we project each manufacturer to earn in future years.

DOT uses MY 2019 National Vehicle Population Profile (NVPP) from IHS Markit—Polk to calculate these percentages.¹¹⁰ These data include vehicle characteristics such as powertrain, fuel type, manufacturer, nameplate, and trim level, as well as the

state in which each vehicle is sold, which allows staff to identify the different types of ZEVs manufacturers sell in the Section 177 state group.

We calculate sales volumes for the ZEV credit requirement based on each manufacturer's future assumed market share in Section 177 states. DOT decided to carry each manufacturer's ZEV market shares forward to future years, after examination of past market share data from MY 2016, from the 2017 version of the NVPP.¹¹¹ Comparison of these data to the 2020 version showed that manufacturers' market shares remain fairly constant in terms of geographic distribution. Therefore, we determined that it was reasonable to carry forward the recently calculated market shares to future years.

We calculate total credits required for ZEV compliance by multiplying the percentages from CARB's ZEV requirement schedule by the Section 177 state volumes. CARB's credit percentage requirement schedule for the years covered in this analysis begins at 9.5 percent in 2020 and ramps up in increments to 22 percent by 2025.¹¹² Note that the requirements do not currently change after 2025.¹¹³

We generate national sales volume predictions for future years using the Compliance Report, a CAFE Model output file that includes simulated sales by manufacturer, fleet, and model year. We use a Compliance Report that corresponds to the baseline scenario of 1.5 percent per year increases in standards for both passenger car and light truck fleets. The resulting national sales volume predictions by manufacturer are then multiplied by each manufacturer's total market share in the Section 177 states to capture the appropriate volumes in the ZEV credits calculation. Required credits by manufacturer, per year, are determined by multiplying the Section 177 state volumes by CARB's ZEV credit percentage requirement. These required credits are subsequently added to the CAFE Model inputs as targets for manufacturer compliance with ZEV standards in the CAFE baseline.

The estimated ZEV credit requirements serve as a target for simulating ZEV compliance in the baseline. To achieve this, DOT determines a modeling philosophy for ZEV pathways, reviews various sources

¹⁰⁶ Rivian, Docket ID No. NHTSA–2021–0053–1562, at p. 2.

¹⁰⁷ US06 is one of the drive cycles used to test fuel economy and all-electric range, specifically for the simulation of aggressive driving. See <https://www.epa.gov/vehicle-and-fuel-emissions-testing/dynamometer-drive-schedules> for more information, as well as Section III.C.4 and Section III.D.3.d). (Accessed: March 6, 2022)

¹⁰⁸ 13 California Code of Regulations (CCR) 1962.2(c)(3).

¹⁰⁹ 13 CCR 1962.2(c)(3).

¹¹⁰ National Vehicle Population Profile (NVPP) 2020, IHS Markit—Polk. At the time of the analysis, MY 2019 data from the NVPP contained the most current estimate of market shares by manufacturer, and best represented the registered vehicle population on January 1, 2020.

¹¹¹ National Vehicle Population Profile (NVPP) 2017, IHS Markit—Polk.

¹¹² See 13 CCR 1962.2(b). The percentage credit requirements are as follows: 9.5 percent in 2020, 12 percent in 2021, 14.5 percent in 2022, 17 percent in 2023, 19.5 percent in 2024, and 22 percent in 2025 and onward.

¹¹³ 13 CCR 1962.2(b).

for information regarding upcoming ZEV programs, and inserts those programs into the analysis fleet inputs. As manufacturers can meet ZEV standards in a variety of different ways, using various technology combinations, the analysis must include certain simplifying assumptions in choosing ZEV pathways. We made these assumptions in conjunction with guidance from CARB staff. The following sections discuss the approach used to simulate a pathway to ZEV program compliance in this analysis.

First, DOT targeted 2025 compliance, as opposed to assuming manufacturers would perfectly comply with their credit requirements in each year prior to 2025. This simplifying assumption was made upon review of past history of ZEV credit transfers, existing ZEV credit banks, and redesign schedules. DOT focused on integrating ZEV technology throughout that timeline with the target of meeting 2025 obligations; thus, some manufacturers are estimated to over-comply or under-comply, depending on their individual situations, in the years 2021–2024.

Second, DOT determined that the most reasonable way to model ZEV compliance would be to allow under-compliance in certain cases and assume that some manufacturers would not meet their ZEV obligation on their own in 2025. Instead, these manufacturers were assumed to prefer to purchase credits from another manufacturer with a credit surplus. Reviews of past ZEV credit transfers between manufacturers informed the decision to make this simplifying assumption.¹¹⁴ CARB advised that for these manufacturers, the CAFE Model should still project that each manufacturer meet approximately 80 percent of their ZEV requirements with technology included in their own portfolio. Manufacturers that were observed to have generated many ZEV credits in the past or had announced major upcoming BEV initiatives were projected to meet 100 percent of their ZEV requirements on their own, without purchasing ZEV credits from other manufacturers.¹¹⁵

Third, DOT agreed that manufacturers would meet their ZEV credit requirements in 2025 though the

production of BEVs. As discussed above, manufacturers may choose to build PHEVs or FCVs to earn some portion of their required ZEV credits. However, DOT projected that manufacturers would rely on BEVs to meet their credit requirements, based on reviews of press releases and industry news, as well as discussion with CARB. Since nearly all manufacturers have announced some plans to produce BEVs at a scale meaningful to future ZEV requirements, DOT agreed that this was a reasonable assumption.¹¹⁶ Furthermore, as CARB only allows intermediate-volume manufacturers to meet their ZEV credit requirements through the production of PHEVs, and the volume status of these few manufacturers could change over the years, assuming BEV production for ZEV compliance is the most straightforward path.

Fourth, to account for the new BEV programs announced by some manufacturers, DOT identified vehicles in the 2020 fleet that closely matched the upcoming BEVs, by regulatory class, market segment, and redesign schedule. DOT made an effort to distribute ZEV candidate vehicles by CAFE regulatory class (light truck, passenger car), by manufacturer, in a manner consistent with the 2020 manufacturer fleet mix. Since passenger car and light truck mixes by manufacturer could change in response to the CAFE policy alternative under consideration, this effort was deemed necessary in order to avoid redistributing the fleet mix in an unrealistic manner. However, there were some exceptions to this assumption, as some manufacturers are already closer to meeting their ZEV obligation through 2025 with BEVs currently produced, and some manufacturers underperform their compliance targets more so in one fleet than another. In these cases, DOT deviated from keeping the LT/PC mix of BEVs evenly distributed across the manufacturer's portfolio.¹¹⁷

DOT then identified future ZEV programs that could plausibly contribute towards the ZEV requirements for each manufacturer by 2025. To obtain this information, DOT examined various sources, including trade press releases, industry announcements, and investor reports. In many cases, these BEV programs are in addition to programs already in

production.¹¹⁸ Some manufacturers have not yet released details of future electric vehicle programs at the time of writing, but have indicated goals of reaching certain percentages of electric vehicles in their portfolios by a specified year. In these cases, DOT reviewed the manufacturer's current fleet characteristics as well as the aspirational information in press releases and other news in order to make reasonable assumptions about the vehicle segment and range of those future BEVs. No changes in BEV program assumptions were made between the NPRM and this document.

Overall, analysts assumed that manufacturers would lean towards producing BEV300s rather than BEV200s, based on the information reviewed and an initial conversation with CARB.¹¹⁹ Phase-in caps were also considered, especially for BEV200, with the understanding that the CAFE Model will always pick BEV200 before BEV300 or BEV400, until the quantity of BEV200s is exhausted. See Section III.D.3.c) for details regarding BEV phase-in caps.

BEVs with smaller battery packs and less range are less likely to meet all the performance needs of traditional pickup truck owners today, such as long-range towing. However, longer-range BEV pickups are being introduced, and may be joined by new markets in the form of electric delivery trucks and some light-duty electric truck applications in state and local government. The extent to which BEVs will be used in these and other new markets is difficult to project. DOT did identify certain trucks as upcoming BEVs for ZEV compliance, and these BEVs were expected to have higher ranges, due to the specific performance needs associated with these vehicles. Outside of the ZEV inputs described here, the CAFE Model does not handle the application of BEV technology with any special considerations as to whether the vehicle is a pickup truck or not.

Finally, in order to simulate manufacturers' compliance with their particular ZEV credits target, 142 rows in the analysis fleet were identified as substitutes for future ZEV programs. As discussed above, the analysis fleet summarizes the roughly 13.6 million light-duty vehicles produced and sold in the United States in MY 2020 with more than 3,500 rows, each reflecting

¹¹⁴ See <https://ww2.arb.ca.gov/our-work/programs/advanced-clean-cars-program/zev-program/zero-emission-vehicle-credit-balances> for past credit balances and transfer information. (Accessed: February 16, 2022)

¹¹⁵ The following manufacturers were assumed to meet 100-percent ZEV compliance: Ford, General Motors, Hyundai, Kia, Jaguar Land Rover, and Volkswagen Automotive. Tesla was also assumed to meet 100 percent of its required standards, but the analyst team did not need to add additional ZEV substitutes to the baseline for this manufacturer.

¹¹⁶ See TSD Chapter 2.3 for a list of potential BEV programs recently announced by manufacturers.

¹¹⁷ The GM light truck and passenger car distribution is one such example.

¹¹⁸ Examples of BEV programs already in production include the Nissan Leaf and the Chevrolet Bolt.

¹¹⁹ BEV300s are 300-mile range battery-electric vehicles. See Section III.D.3.b) for further information regarding electrification fleet assignments.

information for one vehicle type observed. Each row includes the vehicle's nameplate and trim level, the sales volume, engine, transmission, drive configuration, regulatory class, projected redesign schedule, and fuel saving technologies, among other attributes.

As the goal of the ZEV analysis is to simulate compliance with the ZEV program in the baseline, and the analysis fleet only contains vehicles produced during MY 2020, DOT identified existing models in the analysis fleet that shared certain characteristics with upcoming BEVs. DOT also focused on identifying substitute vehicles with redesign years similar to the future BEV's introduction year. The sales volumes of those existing models, as predicted for 2025, were then used to simulate production of the upcoming BEVs. DOT identified a combination of rows that would meet the ZEV target, could contribute productively towards CAFE program obligations (by manufacturer and by fleet), and would introduce BEVs in each manufacturer's portfolio in a way that reasonably aligned with projections and announcements. DOT tagged each of these rows with information in the Market Data file, instructing the CAFE Model to apply the specified BEV technology to the row at the first redesign year, regardless of the scenario or type of CAFE or GHG simulation.

The CAFE Model does not optimize compliance with the ZEV mandate; it relies upon the inputs described in this section in order to estimate each manufacturer's resulting ZEV credits. The resulting amount of ZEV credits earned by manufacturer for each model year can be found in the CAFE Model's Compliance file.

Not all ZEV-qualifying vehicles in the U.S. earn ZEV credits, as they are not all sold in states that have adopted ZEV regulations. In order to reflect this in the CAFE Model, which only estimates sales volumes at the national level, the percentages calculated for each manufacturer are used to scale down the national-level volumes. Multiplying national-level ZEV sales volumes by these percentages ensures that only the ZEVs sold in Section 177 states count towards the ZEV credit targets of each manufacturer.¹²⁰ See Section 5.8 of the

¹²⁰ The single exception to this assumption is Mazda, as Mazda has not yet produced any ZEV-qualifying vehicles at the time of writing. Thus, the percentage of ZEVs sold in Section 177 states cannot be calculated from existing data. However, Mazda has indicated its intention to produce ZEV-qualifying vehicles in the future, so DOT assumed that 100 percent of future ZEVs would be sold in Section 177 states for the purposes of estimating ZEV credits in the CAFE Model.

CAFE Model Documentation for a detailed description of how the model applied these ZEV technologies and any changes made to the model's programming for the incorporation of the ZEV program into the baseline.

As discussed above, DOT made an effort to distribute the newly identified ZEV candidates between CAFE regulatory classes (light truck and passenger car) in a manner consistent with the proportions seen in the 2020 analysis fleet, by manufacturer. As mentioned previously, there were a few exceptions to this assumption in cases where manufacturers' regulatory class distribution of current or planned ZEV programs clearly differed from their regulatory class distribution as a whole.

In some instances, the regulatory distribution of flagged ZEV candidates leaned towards a higher portion of PCs. The reasoning behind this differs in each case, but there is an observed pattern in the 2020 analysis fleet of fewer BEVs being light trucks, especially pickups. The 2020 analysis fleet contains no BEV pickups in the light truck segment. The slow emergence of electric pickups could be linked to the specific performance needs associated with pickup trucks. However, the market for BEVs may emerge in unexpected ways that are difficult to project. Examples of this include anticipated electric delivery trucks and light-duty electric trucks used by state and local governments. Due to these considerations, DOT tagged some trucks as BEVs for ZEV, and expected that these would generally be of higher ranges.

TSD Chapter 2.3 includes more information about the process we use to simulate ZEV program compliance in this analysis.

4. Technology Effectiveness Values

The next input we use to simulate manufacturers' decision-making processes for the year-by-year application of technologies to specific vehicles are estimates of how effective each technology would be at reducing fuel consumption. For this analysis, we use full-vehicle modeling and simulation to estimate the fuel economy improvements manufacturers could make to a fleet of vehicles, considering the vehicles' technical specifications and how combinations of technologies interact. Full-vehicle modeling and simulation uses physics-based models to predict how combinations of technologies perform as a full system under defined conditions. We use full vehicle simulations performed in Autonomie, a physics-based full-vehicle modeling and simulation software

developed and maintained by the U.S. Department of Energy's Argonne National Laboratory.¹²¹

A model is a mathematical representation of a system, and simulation is the behavior of that mathematical representation over time. In this analysis, the model is a mathematical representation of an entire vehicle,¹²² including its individual components such as the engine and transmission, overall vehicle characteristics such as mass and aerodynamic drag, and the environmental conditions, such as ambient temperature and barometric pressure. We simulate the model's behavior over test cycles, including the 2-cycle laboratory compliance tests (or 2-cycle tests),¹²³ to determine how the individual components interact.

Using full-vehicle modeling and simulation to estimate technology efficiency improvements has two primary advantages over using single or limited point estimates. An analysis using single or limited point estimates may assume that, for example, one fuel economy-improving technology with an effectiveness value of 5 percent by itself and another technology with an effectiveness value of 10 percent by itself, when applied together achieve an additive improvement of 15 percent. Single point estimates generally do not provide accurate effectiveness values because they do not capture complex relationships among technologies. Technology effectiveness often differs significantly depending on the vehicle type (e.g., sedan versus pickup truck) and the way in which the technology interacts with other technologies on the vehicle, as different technologies may provide different incremental levels of fuel economy improvement if implemented alone or in combination with other technologies. Any

¹²¹ Islam, E.S., A. Moawad, N. Kim, R. Vijayagopal, and A. Rousseau. *A Detailed Vehicle Simulation Process to Support CAFE Standards for the MY 2024–2026 Analysis*. ANL/ESD–21/9 (hereinafter, Autonomie model documentation).

¹²² Each full vehicle model in this analysis is composed of sub-models, which is why the full vehicle model could also be referred to as a full system model, composed of sub-system models.

¹²³ EPA's compliance test cycles are used to measure the fuel economy of a vehicle. For readers unfamiliar with this process, it is like running a car on a treadmill following a program—or more specifically, two programs. The "programs" are the "urban cycle," or Federal Test Procedure (abbreviated as "FTP"), and the "highway cycle," or Highway Fuel Economy Test (abbreviated as "HFET"), and they have not changed substantively since 1975. Each cycle is a designated speed trace (of vehicle speed versus time) that all certified vehicles must follow during testing. The FTP is meant roughly to simulate stop and go city driving, and the HFET is meant roughly to simulate steady flowing highway driving at about 50 mph.

oversimplification of these complex interactions leads to less accurate and often overestimated effectiveness estimates.

In addition, because manufacturers often implement several fuel-saving technologies simultaneously when redesigning a vehicle, it is difficult to isolate the effect of individual technologies using laboratory measurement of production vehicles alone. Modeling and simulation offer the opportunity to isolate the effects of individual technologies by using a single or small number of baseline vehicle configurations and incrementally adding technologies to those baseline configurations. This provides a consistent reference point for the incremental effectiveness estimates for each technology and for combinations of technologies for each vehicle type. Vehicle modeling also reduces the potential for overcounting or undercounting technology effectiveness.

An important feature of this analysis is that the incremental effectiveness of each technology and combinations of technologies should be accurate and relative to a consistent baseline vehicle. For this analysis, the baseline absolute fuel economy value for each vehicle in the analysis fleet is based on CAFE compliance data for each make and model.¹²⁴ The absolute fuel economy values of the full vehicle simulations are used only to determine incremental effectiveness and are never used directly to assign an absolute fuel economy value to any vehicle model or configuration. For subsequent technology changes, we apply the incremental effectiveness values of one or more technologies to the baseline fuel economy value to determine the absolute fuel economy achieved for applying the technology change.

As an example, if a Ford F-150 2-wheel drive crew cab and short bed in the analysis fleet has a fuel economy value of 30 mpg for CAFE compliance, 30 mpg will be considered the reference absolute fuel economy value. A similar full vehicle model node in the Autonomie simulation may begin with an average fuel economy value of 32 mpg, and with incremental addition of a specific technology X its fuel economy improves to 35 mpg, a 9.3 percent improvement. In this example, the incremental fuel economy improvement (9.3 percent) from technology X would be applied to the F-150's 30 mpg absolute value.

We determine the incremental effectiveness of technologies as applied to the thousands of unique vehicle and technology combinations in the analysis fleet. Although, as mentioned above, full-vehicle modeling and simulation reduces the work and time required to assess the impact of moving a vehicle from one technology state to another, it would be impractical—if not impossible—to build a unique vehicle model for every individual vehicle in the analysis fleet. Therefore, as discussed in the following sections, the Autonomie analysis relies on ten vehicle technology class models that are representative of large portions of the analysis fleet vehicles. The vehicle technology classes ensure that key vehicle characteristics are reasonably represented in the full vehicle models.

We sought comment on the full vehicle modeling and simulation assumptions used for this analysis and received some comments specific to individual technologies, which are discussed further in the individual technology subsections in final rule Section III.D. However, we did not receive any comments on our use of Autonomie itself. The next sections discuss the details of the technology effectiveness analysis input specifications and assumptions that we continued to use for this final rule analysis.

(a) Full Vehicle Modeling and Simulation

As discussed above, for this analysis we use Argonne's full vehicle modeling tool, Autonomie, to build vehicle models with different technology combinations and simulate the performance of those models over regulatory test cycles. The difference in the simulated performance between full vehicle models, with differing technology combination, is used to determine effectiveness values. We consider over 50 individual technologies as inputs to the Autonomie modeling.¹²⁵ These inputs consist of engine technologies, transmission technologies, powertrain electrification, light-weighting, aerodynamic improvements, and tire rolling resistance improvements. Section III.D broadly discusses each of the technology groupings definitions, inputs, and assumptions. A deeper discussion of the Autonomie modeled subsystems, and how inputs feed the sub models resulting in outputs, is contained in the Autonomie model

documentation that accompanies this analysis. The 50 individual technologies, when considered with the ten vehicle technology classes, result in over 1 million individual vehicle technology combination models. For additional discussion on the full vehicle modeling used in this analysis see TSD Chapter 2.

While Argonne built full-vehicle models and ran simulations for many combinations of technologies, it did not simulate literally every single vehicle model/configuration in the analysis fleet. Not only would it be impractical to assemble the requisite detailed information specific to each vehicle/model configuration, much of which would likely only be provided on a confidential basis, doing so would increase the scale of the simulation effort by orders of magnitude. Instead, Argonne simulated ten different vehicle types, corresponding to the five "technology classes" generally used in CAFE analysis over the past several rulemakings, each with two performance levels and corresponding vehicle technical specifications (*e.g.*, small car, small performance car, pickup truck, performance pickup truck, etc.).

Technology classes are a means of specifying common technology input assumptions for vehicles that share similar characteristics. Because each vehicle technology class has unique characteristics, the effectiveness of technologies and combinations of technologies is different for each technology class. Conducting Autonomie simulations uniquely for each technology class provides a specific set of simulations and effectiveness data for each technology class. In this analysis the technology classes are compact cars, midsize cars, small SUVs, large SUVs, and pickup trucks. In addition, for each vehicle class there are two levels of performance attributes (for a total of 10 technology classes). The high performance and low performance vehicles classifications allow for better diversity in estimating technology effectiveness across the fleet.

For additional discussion on the development of the vehicle technology classes used in this analysis and the attributes used to characterize each vehicle technology class, see TSD Chapter 2.4 and the Autonomie model documentation.

Before any simulation is initiated in Autonomie, Argonne must "build" a vehicle by assigning reference technologies and initial attributes to the components of the vehicle model representing each technology class. The reference technologies are baseline

¹²⁴ See Section III.C.2 for further discussion of CAFE compliance data in the Market Data file.

¹²⁵ See Autonomie model documentation; ANL—All Assumptions_Summary_NPRM_022021.xlsx; ANL—Data Dictionary January 2021.xlsx.

technologies that represent the first step on each technology pathway used in the analysis. For example, a compact car is built by assigning it a baseline engine (DOHC, VVT, PFI), a baseline transmission (AT5), a baseline level of aerodynamic improvement (AERO0), a baseline level of rolling resistance improvement (ROLL0), a baseline level of mass reduction technology (MR0), and corresponding attributes from the Argonne vehicle assumptions database like individual component weights. A baseline vehicle will have a unique starting point for the simulation and a unique set of assigned inputs and attributes, based on its technology class. Argonne collected over a hundred baseline vehicle attributes to build the baseline vehicle for each technology class. In addition, to account for the weight of different engine sizes, like 4-cylinder versus 8-cylinder or turbocharged versus naturally aspirated engines, Argonne developed a relationship curve between peak power and engine weight based on the A2Mac1 benchmarking data. Argonne uses the developed relationship to estimate mass for all engines. For additional discussion on the development and optimization of the baseline vehicle models and the baseline attributes used in this analysis see TSD Chapter 2.4 and the Autonomie model documentation.

The next step in the process is to run a powertrain sizing algorithm that ensures the built vehicle meets or exceeds defined performance metrics, including low-speed acceleration (time required to accelerate from 0–60 mph), high-speed passing acceleration (time required to accelerate from 50–80 mph), gradeability (the ability of the vehicle to maintain constant 65 miles per hour speed on a six percent upgrade), and towing capacity. Together, these performance criteria are widely used by the automotive industry as metrics to quantify vehicle performance attributes that consumers observe and that are important for vehicle utility and customer satisfaction.

As with conventional vehicle models, electrified vehicle models were also built from the ground up. For MY 2020, the U.S. market has an expanded number of available hybrid and electric vehicle models. To capture improvements for electrified vehicles for this analysis, DOT applied a mass regression analysis process that considers electric motor weight versus electric motor power (similar to the regression analysis for internal combustion engine weights) for vehicle models that have adopted electric motors. Benchmarking data for hybrid and electric vehicles from the A2Mac1

database were analyzed to develop a regression curve of electric motor peak power versus electric motor weight.¹²⁶

We maintain performance neutrality in the full vehicle simulations by resizing engines, electric machines, and hybrid electric vehicle battery packs at specific incremental technology steps. To address product complexity and economies of scale, engine resizing is limited to specific incremental technology changes that would typically be associated with a major vehicle or engine redesign. This is intended to reflect manufacturers' comments to DOT on how they consider engine resizing and product complexity, and DOT's observations on industry product complexity. A detailed discussion on powertrain sizing can be found in TSD Chapter 2.4 and in the Autonomie model documentation.

After all vehicle class and technology combination models have been built, Autonomie simulates the vehicles' performance on test cycles to calculate the effectiveness improvement of adding fuel-economy-improving technologies to the vehicle. Simulating vehicles' performance using tests and procedures specified by Federal law and regulations minimizes the potential variation in determining technology effectiveness.

For vehicles with conventional powertrains and micro hybrids, Autonomie simulates the vehicles per EPA 2-cycle test procedures and guidelines.¹²⁷ For mild and full hybrid electric vehicles and FCVs, Autonomie simulates the vehicles using the same EPA 2-cycle test procedure and guidelines, and the drive cycles are repeated until the initial and final state of charge are within a SAE J1711 tolerance. For PHEVs, Autonomie simulates vehicles per similar procedures and guidelines as prescribed in SAE J1711.¹²⁸ For BEVs Autonomie simulates vehicles per similar procedures and guidelines as prescribed in SAE J1634.¹²⁹

We received comments from The International Council on Clean Transportation (ICCT) regarding the application of the engine sizing algorithm, and when it is applied in relation to vehicle road load improvement technologies. ICCT stated that, “[d]ue to the large uncertainties in

when and how to downsize engines for the variety of vehicles, the only acceptable solution is to always model the appropriate amount of engine downsizing to maintain performance.”¹³⁰

We disagree with the comment implying that engine resizing is required for every technology change on a vehicle platform. We believe that this would artificially inflate effectiveness relative to cost. Manufacturers have repeatedly and consistently conveyed that the costs for redesign and the increased manufacturing complexity resulting from continual resizing engine displacement for small technology changes preclude them from doing so. NHTSA believes that it would not be reasonable or cost-effective to expect resizing powertrains for every unique combination of technologies, and even less reasonable and cost-effective for every unique combination of technologies across every vehicle model due to the extreme manufacturing complexity that would be required to do so.¹³¹ In addition, a 2011 NAS report stated that “[f]or small (under 5 percent [of curb weight]) changes in mass, resizing the engine may not be justified, but as the reduction in mass increases (greater than 10 percent [of curb weight]), it becomes more important for certain vehicles to resize the engine and seek secondary mass reduction opportunities.”¹³²

We also believe that ICCT's comment regarding Autonomie's engine resizing process is further addressed by the Autonomie's powertrain calibration process. We do agree that the powertrain should be re-calibrated for every unique technology combination and this calibration is performed as part of the transmission shift initializer routine.¹³³ Autonomie runs the shift initializer routine for every unique Autonomie full vehicle model configuration and generates customized transmission shift maps. The algorithms' optimization is designed to balance minimization of energy consumption and vehicle performance.

(b) Performance Neutrality

The purpose of the CAFE analysis is to examine the impact of technology

¹³⁰ ICCT, Docket No. NHTSA–2021–0053–1581–A1, at p. 5.

¹³¹ For more details, see comments and discussion in the 2020 Rulemaking Preamble Section VI.B.3.a)(6) Performance Neutrality.

¹³² National Research Council 2011. Assessment of Fuel Economy Technologies for Light-Duty Vehicles. Washington, DC: The National Academies Press. <https://doi.org/10.17226/12924> (hereinafter, 2011 NAS Report), at 107.

¹³³ See FRM ANL Model Documentation at Paragraph 4.4.5.2.

¹²⁶ See Autonomie model documentation, Chapter 5.2.10, Electric Machines System Weight.

¹²⁷ 40 CFR part 600.

¹²⁸ PHEV testing is broken into several phases based on SAE J1711: Charge-sustaining on the city cycle and HWFET cycle, and charge-depleting on the city and HWFET cycles.

¹²⁹ SAE J1634. “Battery Electric Vehicle Energy Consumption and Range Test Procedure.” July 12, 2017.

application that can improve fuel economy. When the fuel economy-improving technology is applied, frequently the manufacturer must choose how the technology will affect the vehicle. The advantages of the new technology can either be completely applied to improving fuel economy or be used to increase vehicle performance while maintaining the existing fuel economy, or some mix of the two effects. Historically, vehicle performance, historically equated with horsepower, has improved over the years as more technology is applied to the fleet. The average horsepower is the highest that it has ever been; all vehicle types have improved horsepower by at least 43 percent compared to the 1978 model year, and pickup trucks have improved by 49 percent.¹³⁴ Fuel economy has also improved, but the horsepower and acceleration trends show that not 100 percent of technological improvements have been applied to fuel savings. While future trends are uncertain, the past trends suggest that vehicle performance is unlikely to decrease, as it seems reasonable to assume that customers will, at a minimum, demand vehicles that offer the same utility as today's fleet.

For this rulemaking analysis, we analyzed technology pathways manufacturers could use for compliance that attempt to maintain vehicle attributes, utility, and performance. Using this approach allows us to assess the costs and benefits of potential standards under a scenario where consumers continue to get the similar vehicle attributes and features, other than changes in fuel economy. The purpose of constraining vehicle attributes is to simplify the analysis and reduce variance in other attributes that consumers may value across the analyzed regulatory alternatives. This allows for a streamlined accounting of costs and benefits by not requiring the values of other vehicle attributes.

To confirm minimal differences in performance metrics across regulatory alternatives, we analyzed the sales-weighted average 0–60 mph acceleration performance of the entire simulated vehicle fleet for MYs 2020 and 2029. The analysis compared performance under the baseline standards and Preferred Alternative. For the NPRM, this analysis identified that the analysis fleet under the No-Action Alternative in MY 2029 had a 0.77 percent worse 0–

60 mph acceleration time than under the Preferred Alternative; in other words, the alternative with the higher fuel economy standards also showed greater acceleration and performance. For the final rule analysis, using the similar approach yielded a 0.0615 percent better (as compared to the baseline) 0–60 mph acceleration time, indicating there is minimal difference in performance between the alternatives. This assessment shows that for this analysis, the performance difference is minimal across regulatory alternatives and across the simulated model years, which allows for fair, direct comparison among the alternatives. Further details about this assessment can be found in TSD Chapter 2.4.5.

Overall, commenters were supportive of our approach to maintaining performance neutrality and the metrics we use to accomplish this. Commenters said we should continue to improve our methodologies for maintaining performance neutrality.¹³⁵ Auto Innovators stated that “[t]he [a]gencies have historically sought to maintain the performance characteristics of vehicles modeled with fuel economy-improving technologies.” They added that they “appreciate that the [a]gencies continue to consider high- speed acceleration, gradeability, towing, range, traction, and interior room (including headroom) in the analysis when sizing powertrains and evaluating pathways for road-load reductions.” Finally, they stated that “[a]ll of these parameters should be considered separately, not just in combination. (For example, we do not support an approach where various acceleration times are added together to create a single ‘performance’ statistic. Manufacturers must provide all types of performance, not just one or two to the detriment of others.)”

The RV Industry Association commented that the agency should include towing capacity considerations for large SUVs because of the public's reliance on large SUVs for RV towing.¹³⁶ Currently, our analysis assumes that SUVs are primarily used for carrying passengers and cargo and towing is not their primary function, in contrast to how full-size pickups are characterized in the analysis. Other aspects of the analysis capture potential performance limitations for SUVs such as limiting the adoption of technologies that could be considered less practical for SUVs. For example, for some larger SUVs with higher power density requirements, we

limit HCR engine technologies and power-split strong hybrid powertrains. For more details on these limitations, see Section III.D.1.c) of this preamble for each technology pathway.

For this final rule analysis, we continued to use the same methodology for modeling full vehicles and maintaining performance neutrality. As such, the estimated compliance costs reflect the assumption that manufacturers will resize powertrains or make other adjustments to maintain performance while increasing fuel economy. We will continue to monitor performance neutrality metrics and their incorporation as part of future analyses.

(c) Implementation in the CAFE Model

The CAFE Model uses two elements of information from the large amount of data generated by the Autonomie simulation runs: Battery costs, and fuel consumption on the city and highway cycles. We combine the fuel economy information from the two cycles to produce a composite fuel economy for each vehicle, and for each fuel used in dual fuel vehicles. The fuel economy information for each simulation run is converted into a single value for use in the CAFE Model.

In addition to the technologies in the Autonomie simulation, the CAFE Model also incorporated a handful of technologies not explicitly simulated in Autonomie. These technologies' performance either could not be captured on the 2-cycle test, or there were no robust data usable as an input for full-vehicle modeling and simulation. The specific technologies are discussed in the individual technology sections below and in TSD Chapter 3. To calculate fuel economy improvements attributable to these additional technologies, estimates of fuel consumption improvement factors were developed and scale multiplicatively when applied together. See TSD Chapter 3 for a complete discussion on how these factors were developed. The Autonomie-simulated results and additional technologies are combined, forming a single dataset used by the CAFE Model.

Each line in the CAFE Model dataset represents a unique combination of technologies. We organize the records using a unique technology state vector, or technology key (tech key), that describes the technology content associated with each unique record. The modeled 2-cycle fuel economy (miles per gallon) of each combination is converted into fuel consumption (gallons per mile) and then normalized relative to a baseline tech key. The improvement factors used by the model

¹³⁴ “The 2021 EPA Automotive Trends Report, Greenhouse Gas Emissions, Fuel Economy, and Technology since 1975,” EPA-420-R-21-023, November 2021, at pp. 20–7 (hereinafter, 2021 EPA Automotive Trends Report).

¹³⁵ RV Industry Association, Docket No. NHTSA-2021-0053-0053, at 4; Auto Innovators, Docket No. NHTSA-2021-0053-1492, at p. 62.

¹³⁶ RV Industry Association, at p. 4.

are a given combination's fuel consumption improvement relative to the baseline tech key in its technology class.

The tech key format was developed by recognizing that most of the technology pathways are unrelated and are only logically linked to designate the direction in which technologies are allowed to progress. As a result, it is possible to condense the paths into groups based on the specific technology. These groups are used to define the technology vector, or tech key. The following technology groups defined the tech key: Engine cam configuration (CONFIG), VVT engine technology (VVT), VVL engine technology (VVL), SGDI engine technology (SGDI), DEAC engine technology (DEAC), non-basic engine technologies (ADVENG), transmission technologies (TRANS), electrification and hybridization (ELEC), low rolling resistance tires (ROLL), aerodynamic improvements (AERO), mass reduction levels (MR), EFR engine technology (EFR), electric accessory improvement technologies (ELEGACC), LDB technology (LDB), and SAX technology (SAX). This summarizes to a tech key with the following fields: CONFIG; VVT; VVL; SGDI; DEAC; ADVENG; TRANS; ELEC; ROLL; AERO; MR; EFR; ELEGACC; LDB; SAX. It should be noted that some of the fields may be blank for some tech key combinations. These fields will be left visible for the examples below, but blank fields may be omitted from tech keys shown elsewhere in the documentation.

As an example, a technology state vector describing a vehicle with a SOHC engine, variable valve timing (only), a 6-speed automatic transmission, a belt-integrated starter generator, rolling resistance (level 1), aerodynamic improvements (level 2), mass reduction (level 1), electric power steering, and low drag brakes, would be specified as "SOHC; VVT; ; ; ; AT6; BISG; ROLL10; AERO20; MR1; ; EPS; LDB ; ." ¹³⁷

Once a vehicle is assigned (or mapped) to an appropriate tech key, adding a new technology to the vehicle simply represents progress from a previous tech key to a new tech key. The previous tech key refers to the technologies that are currently in use on a vehicle. The new tech key is

determined, in the simulation, by adding a new technology to the combination represented by the previous state vector while simultaneously removing any technologies that are superseded by the newly added one.

For example, start with a vehicle with the tech key: SOHC; VVT; AT6; BISG; ROLL10; AERO20; MR1; EPS; LDB. Assume the simulation is evaluating PHEV20 as a candidate technology for application on this vehicle. The new tech key for this vehicle is computed by removing SOHC, VVT, AT6, and BISG technologies from the previous state vector,¹³⁸ and adding PHEV20, resulting a tech key that looks like this: PHEV20; ROLL10; AERO20; MR1; EPS; LDB.

From here, the simulation obtains a fuel economy improvement factor for the new combination of technologies and applies that factor to the fuel economy of a vehicle in the analysis fleet. The resulting improvement is applied to the original compliance fuel economy value for a discrete vehicle in the analysis fleet.

5. Defining Technology Adoption in the Rulemaking Timeframe

As discussed in Section III.C.2, starting with a fixed analysis fleet (for this analysis, the MY 2020 fleet indicated in manufacturers' early CAFE compliance data), the CAFE Model estimates ways each manufacturer could potentially apply specific fuel-saving technologies to specific vehicle model/configurations in response to, among other things (such as fuel prices), CAFE standards, CO₂ standards, commitments some manufacturers have made to CARB's "Framework Agreements," and ZEV mandates imposed by California and several other states. The CAFE Model follows a year-by-year approach to simulating manufacturers' potential decisions to apply technology, accounting for multiyear planning within the context of estimated schedules for future vehicle redesigns and refreshes during which significant technology changes may most practicably be implemented.

The modeled technology adoption for each manufacturer under each regulatory alternative depends on this representation of multiyear planning, and on a range of other factors represented by other model characteristics and inputs, such as the logical progression of technologies defined by the model's technology pathways; the technologies already

present in the analysis fleet; inputs directing the model to "skip" specific technologies for specific vehicle model/configurations in the analysis fleet (e.g., because secondary axle disconnect cannot be applied to 2-wheel-drive vehicles, and because manufacturers already heavily invested in engine turbocharging and downsizing are unlikely to abandon this approach in favor of using high compression ratios); inputs defining the sharing of engines, transmissions, and vehicle platforms in the analysis fleet; the model's logical approach to preserving this sharing; inputs defining each regulatory alternative's specific requirements; inputs defining expected future fuel prices, annual mileage accumulation, and valuation of avoided fuel consumption; inputs defining the estimated efficacy and future cost (accounting for projected future "learning" effects) of included technologies; inputs controlling the maximum pace the simulation is to "phase in" each technology; and inputs further defining the availability of each technology to specific technology classes.

Two of these inputs—the "phase-in cap" and the "phase-in start year"—apply to the manufacturer's entire estimated production and, for each technology, define a share of production in each model year that, once exceeded, will stop the model from further applying that technology to that manufacturer's fleet in that model year. The influence of these inputs varies with regulatory stringency and other model inputs. For example, setting the inputs to allow immediate 100 percent penetration of a technology will not guarantee any application of the technology if stringency increases are low and the technology is not at all cost effective. Also, even if these are set to allow only very slow adoption of a technology, other model aspects and inputs may nevertheless force more rapid application than these inputs, alone, would suggest (e.g., because an engine technology propagates quickly due to sharing across multiple vehicles, or because BEV application must increase quickly in response to ZEV requirements). For this analysis, nearly all of these inputs are set at levels that do not limit the simulation at all.

As discussed below, for the most advanced engines (advanced cylinder deactivation, variable compression ratio, variable turbocharger geometry, and turbocharging with cylinder deactivation), we have specified phase-in caps and phase-in start years that limit the pace at which the analysis shows the technology being adopted in

¹³⁷In the example tech key, the series of semicolons between VVT and AT6 correspond to the engine technologies which are not included as part of the combination, while the gap between MR1 and EPS corresponds to EFR and the omitted technology after LDB is SAX. The extra semicolons for omitted technologies are preserved in this example for clarity and emphasis and will not be included in future examples.

¹³⁸For more discussion of how the CAFE Model handles technology supersession, see S4.5 of the CAFE Model Documentation.

the rulemaking timeframe. For example, this analysis applies a 34-percent phase-in cap and MY 2019 phase-in start year for advanced cylinder deactivation (ADEAC), meaning that in MY 2021 (using a MY 2020 fleet, the analysis begins simulating further technology application in MY 2021), the model will stop adding ADEAC to a manufacturer's MY 2021 fleet once ADEAC reaches more than 68-percent penetration, because $34\% \times (2021 - 2019) = 34\% \times 2 = 68\%$.

We apply phase-in caps and corresponding start years to prevent the simulation from showing unlikely rates of applying battery-electric vehicles (BEVs), such as showing that a manufacturer producing very few BEVs in MY 2020 could plausibly replace every product with a 300- or 400-mile BEV by MY 2025. Also, as discussed in Section III.D.4, we apply phase-in caps and corresponding start years intended to ensure that the simulation's plausible application of the highest included levels of mass reduction (20 and 28.2 percent reductions of vehicle "glider" weight) do not, for example, outpace plausible supply of raw materials and development of entirely new manufacturing facilities.

These model logical structures and inputs act together to produce estimates of ways each manufacturer could potentially shift to new fuel-saving technologies over time, reflecting some measure of protection against rates of change not reflected in, for example, technology cost inputs. This does not mean that every modeled solution would necessarily be economically practicable. Using technology adoption features like phase-in caps and phase-in start years is one mechanism that can be used so that the analysis better represents the potential costs and benefits of technology application in the rulemaking timeframe.

6. Technology Costs

DOT estimates present and future costs for fuel-saving technologies taking into consideration the type of vehicle, or type of engine if technology costs vary by application. These cost estimates are based on three main inputs. First, we estimate direct manufacturing costs (DMCs), or the component and labor costs of producing and assembling the physical parts and systems, assuming high volume production. DMCs

generally do not include the indirect costs of tools, capital equipment, financing costs, engineering, sales, administrative support or return on investment. DOT accounts for these indirect costs via a scalar markup of direct manufacturing costs (the retail price equivalent, or RPE). Finally, costs for technologies may change over time as industry streamlines design and manufacturing processes. To reflect this, DOT estimates potential cost improvements with learning effects (LE). The retail cost of equipment in any future year is estimated to be equal to the product of the DMC, RPE, and LE. Considering the retail cost of equipment, instead of merely direct manufacturing costs, is important to account for the real-world price effects of a technology, as well as market realities.

(a) Direct Manufacturing Costs

Direct manufacturing costs (DMCs) are the component and assembly costs of the physical parts and systems that make up a complete vehicle. The analysis uses agency-sponsored tear-down studies of vehicles and parts to estimate the DMCs of individual technologies, in addition to independent tear-down studies, other publications, and confidential business information. In the simplest cases, the agency-sponsored studies produce results that confirm third-party industry estimates and align with confidential information provided by manufacturers and suppliers. In cases with a large difference between the tear-down study results and credible independent sources, DOT scrutinized the study assumptions, and sometimes revised or updated the analysis accordingly.

Due to the variety of technologies and their applications, and the cost and time required to conduct detailed tear-down analyses, the agency did not sponsor tear-down studies for every technology. In addition, we consider some fuel-saving technologies that are pre-production or are sold in very small pilot volumes. For those technologies, DOT could not conduct a tear-down study to assess costs because the product is not yet in the marketplace for evaluation. In these cases, DOT relied upon third-party estimates and confidential information from suppliers and manufacturers; however, there are some common pitfalls with relying on

confidential business information to estimate costs. The agency and the source may have had incongruent or incompatible definitions of "baseline." The source may have provided DMCs at a date many years in the future, and assumed very high production volumes, important caveats to consider for agency analysis. In addition, a source, under no contractual obligation to DOT, may provide incomplete and/or misleading information. In other cases, intellectual property considerations and strategic business partnerships may have contributed to a manufacturer's cost information and could be difficult to account for in the CAFE Model as not all manufacturers may have access to proprietary technologies at stated costs. The agency carefully evaluates new information in light of these common pitfalls, especially regarding emerging technologies.

While costs for fuel-saving technologies reflect the best estimates available today, technology cost estimates will likely change in the future as technologies are deployed and as production is expanded. For emerging technologies, DOT uses the best information available at the time of the analysis and will continue to update cost assumptions for any future analysis. The discussion of each category of technologies in Section III.D (e.g., engines, transmissions, electrification) and corresponding TSD Chapter 3 summarizes the specific cost estimates DOT applied for this analysis.

(b) Indirect Costs (Retail Price Equivalent)

As discussed above, direct costs represent the cost associated with acquiring raw materials, fabricating parts, and assembling vehicles with the various technologies manufacturers are expected to use to meet future CAFE standards. They include materials, labor, and variable energy costs required to produce and assemble the vehicle. However, they do not include overhead costs required to develop and produce the vehicle, costs incurred by manufacturers or dealers to sell vehicles, or the profit manufacturers and dealers make from their investments. All of these items contribute to the price consumers ultimately pay for the vehicle. These components of retail prices are illustrated in Table III-3 below.

Table III-3 – Retail Price Components

Direct Costs	
Manufacturing Cost	Cost of materials, labor, and variable energy needed for production
Indirect Costs	
Production Overhead	
Warranty	Cost of providing product warranty
Research and Development	Cost of developing and engineering the product
Depreciation and amortization	Depreciation and amortization of manufacturing facilities and equipment
Maintenance, repair, operations	Cost of maintaining and operating manufacturing facilities and equipment
Corporate Overhead	
General and Administrative	Salaries of nonmanufacturing labor, operations of corporate offices, etc.
Retirement	Cost of pensions for nonmanufacturing labor
Health Care	Cost of health care for nonmanufacturing labor
Selling Costs	
Transportation	Cost of transporting manufactured goods
Marketing	Manufacturer costs of advertising manufactured goods
Dealer Costs	
Dealer selling expense	Dealer selling and advertising expense
Dealer profit	Net Income to dealers from sales of new vehicles
Net income	Net income to manufacturers from production and sales of new vehicles

To estimate the impact of higher vehicle prices on consumers, both direct and indirect costs must be considered. To estimate total consumer costs, DOT multiplies direct manufacturing costs by an indirect cost factor to represent the average price for fuel-saving technologies at retail.

Historically, the method most commonly used to estimate indirect costs of producing a motor vehicle has been the retail price equivalent (RPE). The RPE markup factor is based on an examination of historical financial data contained in 10-K reports filed by manufacturers with the Securities and Exchange Commission (SEC). It represents the ratio between the retail price of motor vehicles and the direct

costs of all activities that manufacturers engage in.

Figure III-4 indicates that for more than three decades, the retail price of motor vehicles has been, on average, roughly 50 percent above the direct cost expenditures of manufacturers. This ratio has been remarkably consistent, averaging roughly 1.5 with minor variations from year to year over this period. At no point has the RPE markup exceeded 1.6 or fallen below 1.4.¹³⁹ During this time frame, the average annual increase in real direct costs was 2.5 percent, and the average annual increase in real indirect costs was also 2.5 percent. Figure III-4 illustrates the historical relationship between retail prices and direct manufacturing costs.¹⁴⁰

An RPE of 1.5 does not imply that manufacturers automatically mark up each vehicle by exactly 50 percent. Rather, it means that, over time, the competitive marketplace has resulted in pricing structures that average out to this relationship across the entire industry. Prices for any individual model may be marked up at a higher or lower rate depending on market demand. The consumer who buys a popular vehicle may, in effect, subsidize the installation of a new technology in a less marketable vehicle. But, on average, over time and across the vehicle fleet, the retail price paid by consumers has risen by about \$1.50 for each dollar of direct costs incurred by manufacturers.

¹³⁹ Based on data from 1972–1997 and 2007. Data were not available for intervening years, but results for 2007 seem to indicate no significant change in the historical trend.

¹⁴⁰ Rogozhin, A., Gallaher, M., & McManus, W., 2009, Automobile Industry Retail Price Equivalent

and Indirect Cost Multipliers. Report by RTI International to Office of Transportation Air Quality. U.S. Environmental Protection Agency, RTI Project Number 0211577.002.004, February, Research Triangle Park, N.C. Spinney, B.C., Faigin, B., Bowie, N., & S. Kratzke, 1999, Advanced Air Bag

Systems Cost, Weight, and Lead Time analysis Summary Report, Contract NO. DTNH22-96-0-12003, Task Orders—001, 003, and 005. Washington, DC, U.S. Department of Transportation.

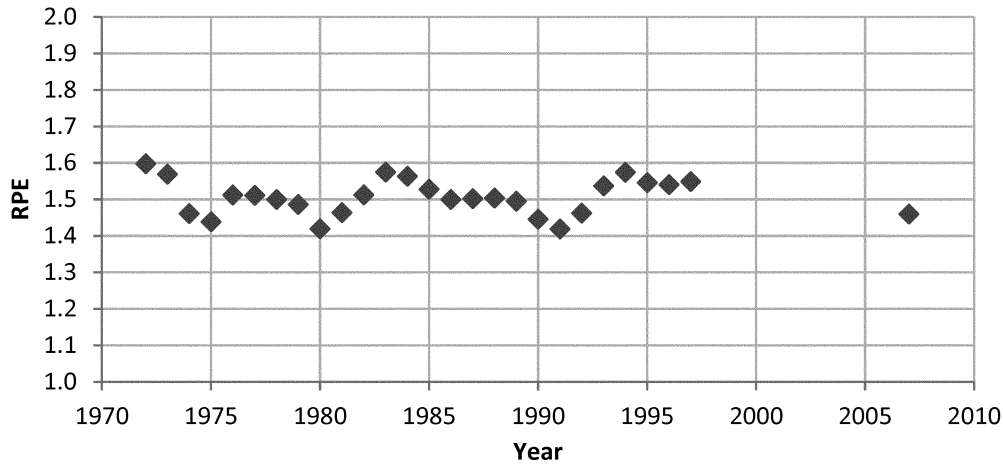

Figure III-4 – Historical Data for Retail Price Equivalent (RPE), 1972-1997 and 2007

It is also important to note that direct costs associated with any specific technology will change over time as some combination of learning and resource price changes occurs. Resource costs, such as the price of steel, can fluctuate over time and can experience real long-term trends in either direction, depending on supply and demand. However, the normal learning process generally reduces direct production costs as manufacturers refine production techniques and seek out less costly parts and materials for increasing production volumes. By contrast, this learning process does not generally influence indirect costs. The implied RPE for any given technology would thus be expected to grow over time as direct costs decline relative to indirect

costs. The RPE for any given year is based on direct costs of technologies at different stages in their learning cycles, and that may have different implied RPEs than they did in previous years. The RPE averages 1.5 across the lifetime of technologies of all ages, with a lower average in earlier years of a technology's life, and, because of learning effects on direct costs, a higher average in later years.

The RPE has been used in all NHTSA safety and most previous CAFE rulemakings to estimate costs. In 2011, the National Academy of Sciences (NAS) recommended RPEs of 1.5 for suppliers and 2.0 for in-house production be used to estimate total costs.¹⁴¹ Auto Innovators, formerly known as the Alliance of Automobile

Manufacturers, also advocated these values as appropriate markup factors for estimating costs of technology changes.¹⁴² In their 2015 report, NAS recommended 1.5 as an overall RPE markup.¹⁴³ An RPE of 2.0 has also been adopted by a coalition of environmental and research groups (NESCCAF, ICCT, Southwest Research Institute, and TIAX-LLC) in a report on reducing heavy truck emissions, and 2.0 is recommended by the U.S. Department of Energy for estimating the cost of hybrid-electric and automotive fuel cell costs (see Vyas et al. (2000) in Table III-4 below). Table III-4 below also lists other estimates of the RPE. Note that all RPE estimates vary between 1.4 and 2.0, with most in the 1.4 to 1.7 range.

¹⁴¹ Effectiveness and Impact of Corporate Average Fuel Economy Standards, Washington, DC—The National Academies Press; NRC, 2011.

¹⁴² Communication from Chris Nevers (Auto Innovators) to Christopher Lieske (EPA) and James

Tamm (NHTSA), <http://www.regulations.gov> Docket ID Nos. NHTSA-2018-0067; EPA-HQ-OAR-2018-0283, p. 143.

¹⁴³ National Research Council 2015. Cost, Effectiveness, and Deployment of Fuel Economy

Technologies for Light Duty Vehicles. Washington, DC: The National Academies Press. <https://doi.org/10.17226/21744> (hereafter, "2015 NAS Report"). (Accessed: February 16, 2022)

Table III-4 – Alternate Estimates of the RPE¹⁴⁴

Author and Year	Value, Comments
Jack Faucett Associates for EPA, 1985	1.26 initial value, later corrected to 1.7+ by Sierra research
Vyas et al., 2000	1.5 for outsourced, 2.0 for OEM, electric, and hybrid vehicles
NRC, 2002	1.4 (corrected to > by Duleep)
McKinsey and Company, 2003	1.7 based on European study
CARB, 2004	1.4 (derived using the JFA initial 1.26 value, not the corrected 1.7+ value)
Sierra Research for AAA, 2007	2.0 or >, based on Chrysler data
Duleep, 2008	1.4, 1.56, 1.7 based on integration complexity
NRC, 2011	1.5 for Tier 1 supplier, 2.0 for OEM
NRC, 2015	1.5 for OEM

The RPE has thus enjoyed widespread use and acceptance by a variety of governmental, academic, and industry organizations.

In past rulemakings, a second type of indirect cost multiplier has also been examined. Known as the “Indirect Cost Multiplier” (ICM) approach, ICMs were first examined alongside the RPE approach in the 2010 rulemaking regarding standards for MYs 2012–2016. Both methods have been examined in subsequent rulemakings.

Consistent with the 2020 final rule, we continue to employ the RPE approach to account for indirect manufacturing costs. The RPE accounts for indirect costs like engineering, sales, and administrative support, as well as other overhead costs, business expenses, warranty costs, and return on capital considerations. A detailed discussion of indirect cost methods and the basis for

our use of the RPE to reflect these costs is available in the FRIA for the 2020 final rule.¹⁴⁵

The Consumer Federation of America (CFA) noted that the inputs we use for indirect costs produce less optimistic results than those used by EPA. They cite these differing results as evidence that our analysis should use the EPA values. CFA states that, “EPA’s benefit cost ratios are much higher affirming that their analysis is more appropriate.”¹⁴⁶ CFA provided no new data or discussion to justify a conclusion that their preferred values are justified empirically, and NHTSA continues to believe that an RPE of 1.5 is the most justified by empirical evidence and research, without regard to the outcomes that a different RPE would produce. We have provided a full description of the basis for choosing the indirect cost values that we use in Chapter 2.6.2 of the TSD accompanying this final rule, as well as in the FRIA accompanying the 2020 final rule. In addition, we note that the RPE value of 1.5 was also used by EPA in its regulatory impact analysis to calculate RPE-inclusive vehicle manufacturer costs.¹⁴⁷

(c) Stranded Capital Costs

The idea behind stranded capital is that manufacturers amortize research, development, and tooling expenses over many years, especially for engines and transmissions. The traditional production life-cycles for transmissions

and engines have been a decade or longer. If a manufacturer launches or updates a product with fuel-saving technology, and then later replaces that technology with an unrelated or different fuel-saving technology before the equipment and research and development investments have been fully paid off, there will be unrecovered, or stranded, capital costs. Quantifying stranded capital costs accounts for such lost investments.

As DOT has observed previously, manufacturers may be shifting their investment strategies in ways that may alter how stranded capital could be considered. For example, some suppliers sell similar transmissions to multiple manufacturers. Such arrangements allow manufacturers to share in capital expenditures or amortize expenses more quickly. Manufacturers share parts on vehicles around the globe, achieving greater scale and greatly affecting tooling strategies and costs.

As a proxy for stranded capital in recent CAFE analyses, the CAFE Model has accounted for platform and engine sharing and includes redesign and refresh cycles for significant and less significant vehicle updates. This analysis continues to rely on the CAFE Model’s explicit year-by-year accounting for estimated refresh and redesign cycles, and shared vehicle platforms and engines, to moderate the cadence of technology adoption and thereby limit the implied occurrence of stranded capital and the need to account for it explicitly. In addition, confining some manufacturers to specific advanced technology pathways through technology adoption features acts as a proxy to indirectly account for stranded capital. Adoption features specific to each technology, if applied on a manufacturer-by-manufacturer basis, are

¹⁴⁴ Duleep, K.G. “2008 Analysis of Technology Cost and Retail Price.” Presentation to Committee on Assessment of Technologies for Improving Light Duty Vehicle Fuel Economy, January 25, Detroit, MI.; Jack Faucett Associates, September 4, 1985. Update of EPA’s Motor Vehicle Emission Control Equipment Retail Price Equivalent (RPE) Calculation Formula. Chevy Chase, MD—Jack Faucett Associates; McKinsey & Company, October 2003. Preface to the Auto Sector Cases. *New Horizons—Multinational Company Investment in Developing Economies*, San Francisco, CA.; NRC (National Research Council), 2002. Effectiveness and Impact of Corporate Average Fuel Economy Standards. Washington, DC—The National Academies Press; NRC, 2011. Assessment of Fuel Economy Technologies for Light Duty Vehicles. Washington, DC—The National Academies Press; Cost, Effectiveness, and Deployment of Fuel Economy Technologies in Light Duty Vehicles. Washington, DC—The National Academies Press, 2015; Sierra Research, Inc., November 21, 2007, Study of Industry-Average Mark-Up Factors used to Estimate Changes in Retail Price Equivalent (RPE) for Automotive Fuel Economy and Emissions Control Systems, Sacramento, CA—Sierra Research, Inc.; Vyas, A. Santini, D., & Cuenca, R. 2000. Comparison of Indirect Cost Multipliers for Vehicle Manufacturing. Center for Transportation Research, Argonne National Laboratory, April. Argonne, Ill.

¹⁴⁵ FRIA, The Safer Affordable Fuel-Efficient (SAFE) Vehicles Rule for Model Year 2021–2026 Passenger Cars and Light Trucks, USDOT, EPA, March 2020, at pp. 354–76.

¹⁴⁶ CFA, Docket No. NHTSA–2021–0053–1535, at p. 5.

¹⁴⁷ FRIA, Revised 2023 and Later Model Year Light-Duty Vehicle GHG Emissions Standards: Regulatory Impact Analysis, US EPA, December 2021, at pp. 4–8.

discussed in each technology section. The agency will monitor these trends to assess the role of stranded capital moving forward.

(d) Cost Learning

Manufacturers make improvements to production processes over time, which often result in lower costs. “Cost learning” reflects the effect of experience and volume on the cost of production, which generally results in better utilization of resources, leading to higher and more efficient production. As manufacturers gain experience through production, they refine production techniques, raw material and component sources, and assembly methods to maximize efficiency and reduce production costs. Typically, a representation of this cost learning, or learning curves, reflects initial learning rates that are relatively high, followed

by slower learning as additional improvements are made and production efficiency peaks. This eventually produces an asymptotic shape to the learning curve, as small percent decreases are applied to gradually declining cost levels. These learning curve estimates are applied to various technologies that are used to meet CAFE standards.

We estimate cost learning by considering methods established by T.P. Wright and later expanded upon by J.R. Crawford.^{148 149} Wright, examining aircraft production, found that every doubling of cumulative production of airplanes resulted in decreasing labor hours at a fixed percentage. This fixed percentage is commonly referred to as the progress rate or progress ratio, where a lower rate implies faster learning as cumulative production increases. J.R. Crawford expanded upon Wright’s

learning curve theory to develop a single unit cost model, which estimates the cost of the n^{th} unit produced given the following information is known: (1) Cost to produce the first unit; (2) cumulative production of n units; and (3) the progress ratio.

As pictured in Figure III–5, Wright’s learning curve shows the first unit is produced at a cost of \$1,000. Initially cost per unit falls rapidly for each successive unit produced. However, as production continues, cost falls more gradually at a decreasing rate. For each doubling of cumulative production at any level, cost per unit declines 20 percent, so that 80 percent of cost is retained. The CAFE Model uses the basic approach by Wright, where cost reduction is estimated by applying a fixed percentage to the projected cumulative production of a given fuel economy technology.

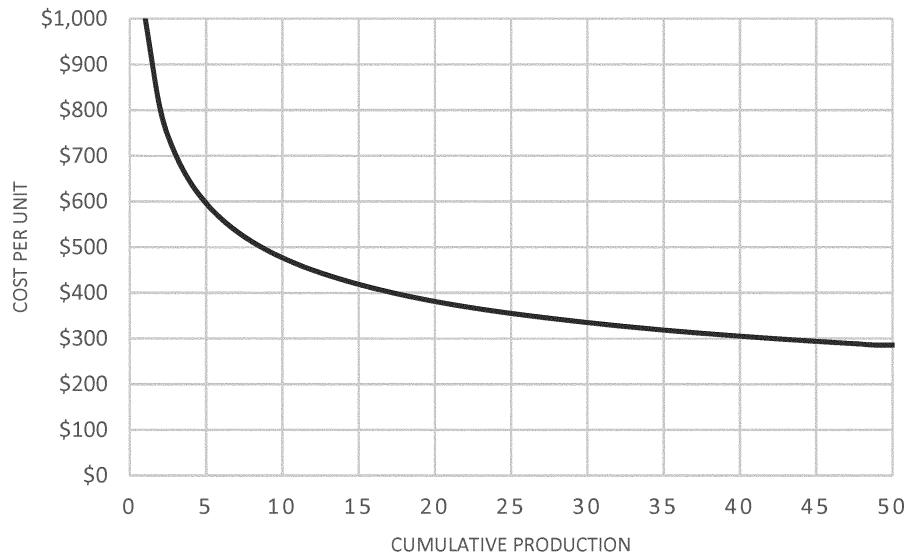

Figure III-5 – Wright’s Learning Curve (Progress Ratio = 0.8)

The analysis accounts for learning effects with model year-based cost learning forecasts for each technology that reduces direct manufacturing costs over time. We evaluate the historical use of technologies, and reviews industry forecasts to estimate future volumes to develop the model year-based technology cost learning curves.

The following section discusses the development of model year-based cost

learning forecasts for this analysis, including how the approach has evolved from the 2012 rulemaking for MY 2017–2025 vehicles, and how the progress ratios were developed for different technologies considered in the analysis. Finally, we discuss how these learning effects are applied in the CAFE Model.

(l) Time Versus Volume-Based Learning

For the 2012 joint CAFE and GHG rulemaking, DOT developed learning curves as a function of vehicle model year.¹⁵⁰ Although the concept of this methodology is derived from Wright’s cumulative production volume-based learning curve, its application for CAFE technologies was more of a function of time. More than a dozen learning curve schedules were developed, varying

¹⁴⁸ Wright, T. P., Factors Affecting the Cost of Airplanes. *Journal of Aeronautical Sciences*, Vol. 3 (1936), at pp. 124–25. Available at <https://www.uvm.edu/pdodds/research/papers/others/>

¹⁴⁹ Crawford, J.R., *Learning Curve, Ship Curve, Ratios, Related Data*, Burbank, California-Lockheed Aircraft Corporation (1944).

¹⁵⁰ 77 FR 62624 (Oct. 15, 2012).

between fast and slow learning, and assigned to each technology corresponding to its level of complexity and maturity. The schedules were applied to the base year of direct manufacturing cost and incorporate a percentage of cost reduction by model year, declining at a decreasing rate through the technology's production life. Some newer technologies experience 20 percent cost reductions for introductory model years, while mature or less complex technologies experience 0–3 percent cost reductions over a few years.

In their 2015 report to Congress, NAS recommended NHTSA should “continue to conduct and review empirical evidence for the cost reductions that occur in the automobile industry with volume, especially for large-volume technologies that will be relied on to meet the CAFE/GHG standards.”¹⁵¹

In response, we incorporated statically projected cumulative volume production data of fuel economy-improving technologies, representing an improvement over the previously used time-based method. Dynamic projections of cumulative production are not feasible with current CAFE Model capabilities, so one set of projected cumulative production data for most vehicle technologies was developed for the purpose of determining cost impact. We obtained historical cumulative production data for many technologies produced and/or

sold in the U.S. to establish a starting point for learning schedules. Groups of similar technologies or technologies of similar complexity may share identical learning schedules.

The slope of the learning curve, which determines the rate at which cost reductions occur, has been estimated using research from an extensive literature review and automotive cost tear-down reports (see below). The slope of the learning curve is derived from the progress ratio of manufacturing automotive and other mobile source technologies.

(2) Deriving the Progress Ratio Used in This Analysis

Learning curves vary among different types of manufactured products. Progress ratios can range from 70 to 100 percent, where 100 percent indicates no learning can be achieved.¹⁵² Learning effects tend to be greatest in operations where workers often touch the product, while effects are less substantial in operations consisting of more automated processes. As automotive manufacturing plant processes become increasingly automated, a progress ratio towards the higher end would seem more suitable. We incorporated findings from automotive cost-teardown studies with EPA's 2015 literature review of learning-related studies to estimate a progress ratio used to determine learning schedules of fuel economy-improving technologies.

EPA's literature review examined and summarized 20 studies related to learning in manufacturing industries and mobile source manufacturing.¹⁵³ The studies focused on many industries, including motor vehicles, ships, aviation, semiconductors, and environmental energy. Based on several criteria, EPA selected five studies providing quantitative analysis from the mobile source sector (progress ratio estimates from each study are summarized in Table III–5, below). Further, those studies expand on Wright's learning curve function by using cumulative output as a predictor variable, and unit cost as the response variable. As a result, EPA determined a best estimate of 84 percent as the progress ratio in mobile source industries. However, of those five studies, EPA at the time placed less weight on the Epple et al. (1991) study, because of a disruption in learning due to incomplete knowledge transfer from the first shift to introduction of a second shift at a North American truck plant. While learning may have decelerated immediately after adding a second shift, we note that unit costs continued to fall as the organization gained experience operating with both shifts. We recognize that disruptions are an essential part of the learning process and should not, in and of themselves, be discredited. For this reason, the analysis uses a re-estimated average progress ratio of 85 percent from those five studies (equally weighted).

Table III-5 – Progress Ratios from EPA's Literature Review

Author (Publication Date)	Industry	Progress Ratio (Cumulative Output Approach)
Argote et al. (1997) ¹⁵⁴	Trucks	85%
Benkard (2000) ¹⁵⁵	Aircraft (commercial)	82%
Epple et al. (1991) ¹⁵⁶	Trucks	90%
Epple et al. (1996) ¹⁵⁷	Trucks	85%
Levitt et al. (2013) ¹⁵⁸	Automobiles	82%

¹⁵¹ 2015 NAS Report.

¹⁵² Martin, J., “What is a Learning Curve?” Management and Accounting Web, University of South Florida, available at: <https://www.maaw.info/LearningCurveSummary.htm>. (Accessed: February 16, 2022)

¹⁵³ *Cost Reduction through Learning in Manufacturing Industries and in the Manufacture of Mobile Sources*, U.S. Environmental Protection Agency (2015). Prepared by ICF International and available at <https://19january2017snapshot.epa.gov/sites/production/>

[files/2016-11/documents/420r16018.pdf](https://www.epa.gov/sites/default/files/2016-11/documents/420r16018.pdf). (Accessed: February 16, 2022)

¹⁵⁴ Argote, L., Epple, D., Rao, R. D., & Murphy, K., *The acquisition and depreciation of knowledge in a manufacturing organization—Turnover and plant productivity*, Working paper, Graduate School of Industrial Administration, Carnegie Mellon University (1997).

¹⁵⁵ Benkard, C. L., *Learning and Forgetting—The Dynamics of Aircraft Production*, The American Economic Review, Vol. 90(4), at 1034–54 (2000).

¹⁵⁶ Epple, D., Argote, L., & Devadas, R., *Organizational Learning Curves—A Method for*

Investigating Intra-Plant Transfer of Knowledge Acquired through Learning by Doing, Organization Science, Vol. 2(1), at 58–70 (1991).

¹⁵⁷ Epple, D., Argote, L., & Murphy, K., *An Empirical Investigation of the Microstructure of Knowledge Acquisition and Transfer through Learning by Doing*, Operations Research, Vol. 44(1), at 77–86 (1996).

¹⁵⁸ Levitt, S. D., List, J. A., & Syverson, C., *Toward an Understanding of Learning by Doing—Evidence from an Automobile Assembly Plant*, Journal of Political Economy, Vol. 121 (4), at 643–81 (2013).

In addition to EPA’s literature review, this progress ratio estimate was informed based on findings from automotive cost-teardown studies. NHTSA routinely performs evaluations of costs of previously issued Federal Motor Vehicle Safety Standards (FMVSS) for new motor vehicles and equipment. NHTSA engages contractors to perform detailed engineering “tear-down” analyses for representative

samples of vehicles, to estimate how much specific FMVSS add to the weight and retail price of a vehicle. As part of the effort, the agency examines cost and production volume for automotive safety technologies. In particular, we estimated costs from multiple cost tear-down studies for technologies with actual production data from the Cost and weight added by the *Federal Motor*

Vehicle Safety Standards for MY 1968–2012 passenger cars and LTVs (2017).¹⁵⁹ We chose five vehicle safety technologies with sufficient data to estimate progress ratios of each, because these technologies are large-volume technologies and are used by almost all vehicle manufacturers. Table III–6 includes these five technologies and yields an average progress rate of 92 percent.

Table III-6 – Progress Ratios Researched by NHTSA

Technology	Progress Ratio
Anti-lock Brake Systems	87%
Driver Airbags	93%
Manual 3-pt lap shoulder safety belts	96%
Adjustable Head Restraints	91%
Dual Master Cylinder	95%

For the final progress ratio used in the CAFE Model, the five progress rates from EPA’s literature review and five progress rates from NHTSA’s evaluation of automotive safety technologies results were averaged. This resulted in an average progress rate of approximately 89 percent. We placed equal weight on progress ratios from all 10 sources. More specifically, we placed equal weight on the *Epple et al. (1991)* study, because disruptions have more recently been recognized as an essential part in the learning process, especially in an effort to increase the rate of output.

(3) Obtaining Appropriate Baseline Years for Direct Manufacturing Costs

DOT obtained direct manufacturing costs for each fuel economy-improving technology from various sources, as discussed above. To establish a consistent basis for direct manufacturing costs in the rulemaking analysis, we adjusted each technology cost to MY 2018 dollars. For each technology, the DMC is associated with a specific model year, and sometimes a specific production volume, or cumulative production volume. The base model year is established as the model year in which direct manufacturing costs were assessed (with learning factor of 1.00). With the aforementioned data on cumulative production volume for each technology and the assumption of a 0.89 progress

ratio for all automotive technologies, we can solve for an implied cost for the first unit produced. For some technologies, we used modestly different progress ratios to match detailed cost projections if available from another source (for instance, batteries for plug-in hybrids and battery electric vehicles).

This approach produces reasonable estimates for technologies already in production, and some additional steps are required to set appropriate learning rates for technologies not yet in production. Specifically, for technologies not yet in production in MY 2017, the cumulative production volume in MY 2017 is zero, because manufacturers have not yet produced the technologies. For pre-production cost estimates in previous CAFE rulemakings, we often relied on confidential business information sources to predict future costs. Many sources for pre-production cost estimates include significant learning effects, often providing cost estimates assuming high volume production, and often for a timeframe late in the first production generation or early in the second generation of the technology. Rapid doubling and re-doubling of a low cumulative volume base with Wright’s learning curves can provide unrealistic cost estimates. In addition, direct manufacturing cost projections can vary depending on the initial production volume assumed. Accordingly, we

carefully examined direct costs with learning, and made adjustments to the starting point for those technologies on the learning curve to better align with the assumptions used for the initial direct cost estimate.

(4) Cost Learning Applied in the CAFE Model

For this analysis, we apply learning effects to the incremental cost over the null technology state on the applicable technology tree. After this step, we calculate year-by-year incremental costs over preceding technologies on the tech tree to create the CAFE Model inputs.¹⁶⁰ The shift from incremental cost accounting to absolute cost accounting in recent CAFE analyses made cost inputs more transparently relatable to detailed model output, and relevant to this discussion, made it easier to apply learning curves in the course of developing inputs to the CAFE Model.

We group certain technologies, such as advanced engines, advanced transmissions, and non-battery electric components and assign them to the same learning schedule. While these grouped technologies differ in operating characteristics and design, we chose to group them based on their complexity, technology integration, and economies of scale across manufacturers. The low volume of certain advanced technologies, such as hybrid and electric technologies, poses a significant issue for suppliers and prevents them

¹⁵⁹ Simons, J. F., *Cost and weight added by the Federal Motor Vehicle Safety Standards for MY 1968–2012 Passenger Cars and LTVs* (Report No.

DOT HS 812 354). Washington, DC—National Highway Traffic Safety Administration (November 2017), at pp. 30–33.

¹⁶⁰ These costs are located in the CAFE Model Technologies file.

from producing components needed for advanced transmissions and other technologies at more efficient high scale production. The technology groupings consider market availability, complexity of technology integration, and production volume of the technologies that can be implemented by manufacturers and suppliers. The details of these technologies are discussed in Section III.D.

In addition, we expanded model inputs to extend the explicit simulation of technology application through MY 2050. Accordingly, we updated the learning curves for each technology group to cover MYs through 2050. For MYs 2017–2032, we expect incremental improvements in all technologies, particularly in electrification technologies because of increased production volumes, labor efficiency, improved manufacturing methods, specialization, network building, and other factors. While these and other factors contribute to continual cost learning, we believe that many fuel

economy-improving technologies considered in this rule will approach a flat learning level by the early 2030s. Specifically, older, and less complex internal combustion engine technologies and transmissions will reach a flat learning curve sooner when compared to electrification technologies, which have more opportunity for improvement. For batteries and non-battery electrification components, we estimated a steeper learning curve that will gradually flatten after MY 2040. For a more detailed discussion of the electrification learning curves, see Section III.D.3.

Each technology in the CAFE Model is assigned a learning schedule developed from the methodology explained previously. For example, the following chart shows learning rates for several technologies applicable to midsize sedans, demonstrating that while we estimate that such learning effects have already been almost entirely realized for engine turbocharging (a technology that has been in production

for many years), we estimate that significant opportunities to reduce the cost of the greatest levels of mass reduction (*e.g.*, MR5) remain, and even greater opportunities remain to reduce the cost of batteries for HEVs, PHEVs, BEVs. In fact, for certain advanced technologies, we determined that the results predicted by the standard learning curves progress ratio was not realistic, based on unusual market price and production relationships. For these technologies, we developed specific learning estimates that may diverge from the 0.89 progress rate. As shown in Figure III–6, these technologies include: Turbocharging and downsizing level 1 (TURBO1), variable turbo geometry electric (VTGE), aerodynamic drag reduction by 15 percent (AERO15), mass reduction level 5 (MR5), 20 percent improvement in low-rolling resistance tire technology (ROLL20) over the baseline, and belt integrated starter/generator (BISG).

BILLING CODE 4910–59–P

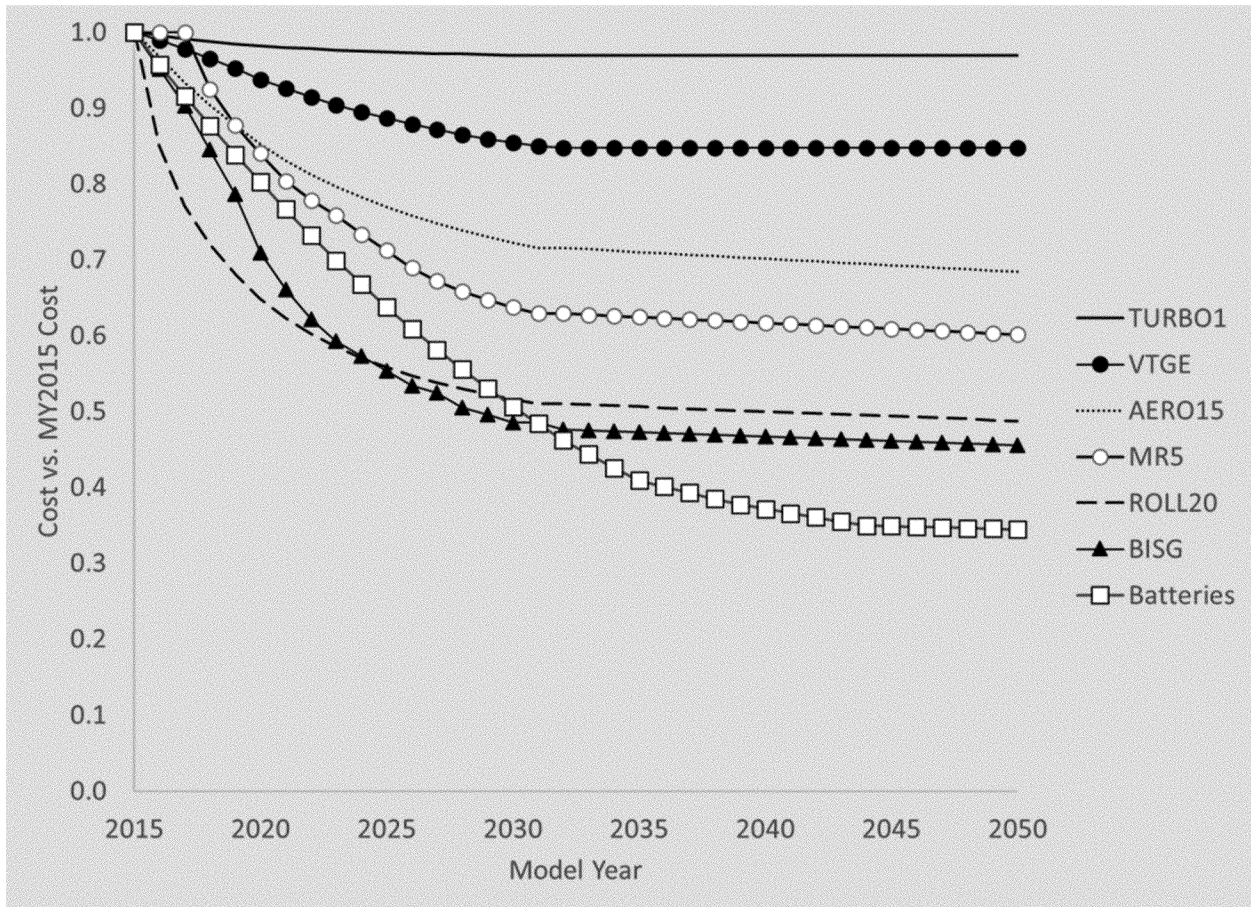

Figure III-6 – Examples of Year-by-Year Cost Learning Effects (Midsize Sedan)

BILLING CODE 4910-59-C

CFA noted that the inputs we use for learning rates produce less optimistic results than those used by EPA. They cite these differing results as evidence that NHTSA should use the EPA values. CFA states that, “EPA’s benefit cost ratios are much higher affirming that their analysis is more appropriate.”¹⁶¹ CFA provided no new data or discussion to justify a conclusion that their preferred values are justified empirically, and NHTSA continues to believe that the appropriate values to use in estimating the impacts of CAFE standards are those most justified by empirical evidence and research, consistent with E.O. 12866, without reference to the outcomes they produce. We have provided a full description of the basis for choosing the learning values that we use in Chapter 2.6.4 of the TSD accompanying this final rule, as well as in the FRIA accompanying the 2020 final rule.

(e) Cost Accounting

To facilitate specification of detailed model inputs and review of detailed model outputs, the CAFE Model continues to use absolute cost inputs relative to a known base component cost, such that the estimated cost of each technology is specified relative to a common reference point for the relevant technology pathway. For example, the cost of a 7-speed transmission is specified relative to a 5-speed transmission, as is the cost of every other transmission technology. Conversely, in some earlier versions of the CAFE Model, *incremental cost* inputs were estimated relative to the technology immediately preceding on the relevant technology pathway. For our 7-speed transmission example, the incremental cost would be relative to a 6-speed transmission. This change in the structure of cost inputs does not, by itself, change model results, but it does make the connection between these inputs and corresponding outputs more transparent. The CAFE Model Documentation accompanying our analysis presents details of the structure for model cost inputs.¹⁶² The individual technology sections in Section III.D provide a detailed discussion of cost accounting for each technology.

7. Manufacturer’s Credit Compliance Positions

This rule involves a variety of provisions regarding “credits” and other compliance flexibilities. Some regulatory provisions allow a

manufacturer to earn “credits” that will be counted toward a vehicle’s rated CO₂ emissions level, or toward a fleet’s rated average CO₂ or CAFE level, without reference to required levels for these average levels of performance. Such flexibilities effectively modify emissions and fuel economy test procedures or methods for calculating fleets’ CAFE and average CO₂ levels. Other provisions (for CAFE, statutory provisions) allow manufacturers to earn credits by achieving CAFE or average CO₂ levels beyond required levels; these provisions may hence more appropriately be termed “compliance credits.” We described in the 2020 final rule how the CAFE Model simulates these compliance credit provisions for both the CAFE program and for EPA’s CO₂ standards.¹⁶³ For this analysis, we modeled the No-Action and Action Alternatives as a set of CAFE standards in place simultaneously with EPA’s 2020 final rule CO₂ standards,¹⁶⁴ related CARB agreements with five manufacturers, and ZEV mandates in place in California and some other states. The modeling of CO₂ standards and standard-like contractual obligations includes our representation of applicable credit provisions.

EPCA has long provided that, by exceeding the CAFE standard applicable to a given fleet in a given model year, a manufacturer may earn corresponding “credits” that the same manufacturer may, within the same regulatory class, apply toward compliance in a different model year. EISA amended these provisions by providing that manufacturers may, subject to specific statutory limitations, transfer compliance credits between regulatory classes and trade compliance credits with other manufacturers. Under the CAA, EPA has broad standard-setting authority and has long provided for averaging, banking, and trading programs in certain circumstances, and in particular for GHGs.

EPCA also specifies that NHTSA may not consider the availability of CAFE credits (for transfer, trade, or direct application) toward compliance with new standards when establishing the standards themselves.¹⁶⁵ Therefore, this analysis excludes MYs 2024–2026 from those in which carried-forward or transferred credits can be applied for the CAFE program.

The “unconstrained” perspective acknowledges that these flexibilities

exist as part of the program and, while not considered by NHTSA in setting standards, are nevertheless important to consider when attempting to estimate the real impact of any alternative. Under the “unconstrained” perspective, credits may be earned, transferred, and applied to deficits in the CAFE program throughout the full range of model years in the analysis. The Final SEIS accompanying this rule presents “unconstrained” modeling results. Also, consistent with the program EPA established under the CAA, this analysis includes simulation of carried-forward and transferred CO₂ credits in all model years.

The CAFE Model, therefore, does provide means to simulate manufacturers’ potential application of some compliance credits, and both the analysis of CO₂ standards and the NEPA analysis of CAFE standards do make use of this aspect of the model. On the other hand, 49 U.S.C. 32902(h) prevents NHTSA from, in its standard setting analysis, considering the potential that manufacturers could use compliance credits in model years for which the agency is establishing maximum feasible CAFE standards. Further, as discussed below, we also continue to find it appropriate for the analysis largely to refrain from simulating two of the mechanisms allowing the use of compliance credits.

The CAFE Model’s approach to simulating compliance decisions accounts for the potential to earn and use CAFE credits as provided by EPCA/EISA. The model similarly accumulates and applies CO₂ credits when simulating compliance with EPA’s standards. Like past versions, the current CAFE Model can simulate credit carry-forward (*i.e.*, banking) between model years and transfers between the passenger car and light truck fleets but not credit carry-back (*i.e.*, borrowing) from future model years or trading between manufacturers.

While NHTSA’s “unconstrained” evaluation can consider the potential to carry back compliance credits from later to earlier model years, past examples of failed attempts to carry back CAFE credits (*e.g.*, a MY 2014 carry back default leading to a civil penalty payment) underscore the riskiness of such “borrowing.” Recent evidence indicates manufacturers are disinclined to take such risks, and we find it reasonable and prudent to refrain from attempting to simulate such “borrowing” in rulemaking analysis.

Like the previous version, the current CAFE Model provides a basis to specify (in model inputs) CAFE credits available from model years earlier than

¹⁶³ See 85 FR 24174, 24303 (April 30, 2020).

¹⁶⁴ The baseline for this analysis is the set of standards in place when NHTSA initiated this rulemaking.

¹⁶⁵ 49 U.S.C. 32902(h)(3).

¹⁶¹ CFA, at p. 5.

¹⁶² CAFE Model Documentation, S4.7.

those being explicitly simulated. For example, with this analysis representing MYs 2020–2050 explicitly, credits earned in the MY 2015 are made available for use through the MY 2020 (given the current five-year limit on carry-forward of credits). The banked credits are specific to both the model year and fleet in which they were earned.

To increase the realism with which the model transitions between the early model years (MYs 2020–2023) and the later years that are the subject of this action, we have accounted for the potential that some manufacturers might trade credits earned prior to 2020 to other manufacturers. However, the analysis refrains from simulating the potential that manufacturers might continue to trade credits during and beyond the model years covered by this action. In 2018 and 2020, the analysis included idealized cases simulating “perfect” (*i.e.*, wholly unrestricted) trading of CO₂ compliance credits by treating all vehicles as being produced by a single manufacturer. Even for CO₂ compliance credit trading, these scenarios were not plausible, because it is exceedingly unlikely that some pairs of manufacturers would trade compliance credits. NHTSA did not include such cases for CAFE compliance credits, because EPCA provisions (such as the minimum domestic passenger car standard requirement) make such scenarios impossible. At this time, we remain concerned that any realistic simulation of such trading would require assumptions regarding which specific pairs of manufacturers might trade compliance credits, and the evidence to date makes it clear that the credit market is far from fully “open.”¹⁶⁶

We also remain concerned that to set standards based on an analysis that presumes the use of program flexibilities risks making the corresponding actions mandatory. Some flexibilities—credit carry-forward (banking) and transfers between fleets in particular—involve little risk because they are internal to a manufacturer and known in advance. As discussed above, credit carry-back involves significant risk because it amounts to borrowing against future improvements, standards, and production volume and mix. Similarly, credit trading may also involve significant risk, because the ability of manufacturer A to acquire credits from manufacturer B depends not just on manufacturer B actually earning the expected amount of credit,

but also on manufacturer B being willing to trade with manufacturer A, and on potential interest by other manufacturers. Manufacturers’ compliance plans have already evidenced cases of compliance credit trades that were planned and subsequently aborted, reinforcing our judgment that, like credit borrowing, credit trading involves too much risk to be included in an analysis that informs decisions about the stringency of future standards. NHTSA will continue to carefully monitor manufacturers’ practices regarding use of credit trading and other flexibilities to ensure that future analyses appropriately account for realistic market conditions and statutory requirements as applicable.

As discussed in the CAFE Model Documentation, the model’s default logic attempts to maximize credit carry-forward—that is, to “hold on” to credits for as long as possible. If a manufacturer needs to cover a shortfall that occurs when insufficient opportunities exist to add technology to achieve compliance with a standard, the model will apply credits. Otherwise, the manufacturer carries forward credits until they are about to expire, at which point it will use them before adding technology that is not considered cost-effective. The model attempts to use credits that will expire within the next three years as a means to smooth out technology applications over time to avoid both compliance shortfalls and high levels of over-compliance that can result in a surplus of credits. Although it remains impossible precisely to predict the manufacturer’s actual earning and use of compliance credits, and this aspect of the model may benefit from future refinement as manufacturers and regulators continue to gain experience with these provisions, this approach is generally consistent with manufacturers’ observed practices.

NHTSA introduced the CAFE Public Information Center (PIC) to provide public access to a range of information regarding the CAFE program,¹⁶⁷ including manufacturers’ credit balances. However, there is a data lag in the information presented on the CAFE PIC that may not capture credit actions across the industry for as much as several months. Furthermore, CAFE credits that are traded between manufacturers are adjusted to preserve the gallons saved that each credit represents.¹⁶⁸ The adjustment occurs at

the time of application rather than at the time the credits are traded. This means that a manufacturer who has acquired credits through trade, but has not yet applied them, may show a credit balance that is either considerably higher or lower than the real value of the credits when they are applied. For example, a manufacturer that buys 40 million credits from Tesla may show a credit balance in excess of 40 million. However, when those credits are applied, they may be worth only 1/10 as much—making that manufacturer’s true credit balance closer to 4 million than 40 million (*e.g.*, when another manufacturer uses credits acquired from Tesla, the manufacturer may only be able to offset a 1 mpg compliance shortfall, even though the credits’ “face value” suggests the manufacturer could offset a 10-mpg compliance shortfall).

Specific inputs accounting for manufacturers’ accumulated compliance credits are discussed in TSD Chapter 2.

In addition to the inclusion of these existing credit banks, the CAFE Model also updated its treatment of credits in the rulemaking analysis. EPCA requires that NHTSA set CAFE standards at maximum feasible levels for each model year without consideration of the program’s credit mechanisms. However, as recent CAFE rulemakings have evaluated the effects of standards over longer time periods, the early actions taken by manufacturers required more nuanced representation. Accordingly, the CAFE Model now provides means to exclude the simulated application of CAFE compliance credits only from specific model years for which standards are being set (for this analysis, 2024–2026), while allowing CAFE credits to be applied in other model years.

In addition to more rigorous accounting of CAFE and CO₂ compliance credits, the model also accounts for air conditioning efficiency and off-cycle adjustments. NHTSA’s program considers those adjustments in a manufacturer’s compliance calculation starting in MY 2017, and specific estimates of each manufacturer’s reliance on these adjustments are discussed above in Section III.C.2.a). Because air conditioning efficiency and off-cycle adjustments are not credits in NHTSA’s program, but rather adjustments to compliance fuel economy, they may be included under either a “standard setting” or “unconstrained” analysis perspective.

gram/mile compliance credits and require no adjustment when traded between manufacturers or fleets.

¹⁶⁶ See, Automotive Innovators, NHTSA–2021–0053–1492, at p. 73.

¹⁶⁷ CAFE Public Information Center, https://one.nhtsa.gov/cape_pic/home (accessed: March 6, 2022).

¹⁶⁸ CO₂ credits for EPA’s program are denominated in metric tons of CO₂ rather than

The manner in which the CAFE Model treats the EPA and CAFE AC efficiency and off-cycle credit programs is similar, but the model also accounts for AC leakage (which is not part of NHTSA's program). When determining the compliance status of a manufacturer's fleet (in the case of EPA's program, PC and LT are the only fleet distinctions), the CAFE Model weighs future compliance actions against the presence of existing (and expiring) CO₂ credits resulting from over-compliance with earlier years' standards, AC efficiency credits, AC leakage credits, and off-cycle credits.

The model currently accounts for any off-cycle adjustments associated with technologies that are included in the set of fuel-saving technologies simulated explicitly (for example, start-stop systems that reduce fuel consumption during idle or active grille shutters that improve aerodynamic drag at highway speeds) and accumulates these adjustments up to levels defined in the Market Data file. As discussed further in Section III.D.8, this analysis considers that some manufacturers may apply up to 15.0 g/mi of off-cycle credit by MY 2032. We considered the potential to model the application of off-cycle technologies explicitly. However, doing so would require data regarding which vehicle models already possess these improvements as well as the cost and expected value of applying them to other models in the future. Such data are currently too limited to support explicit modeling of these technologies and adjustments.

When establishing maximum feasible fuel economy standards, NHTSA is prohibited from considering the availability of alternatively fueled vehicles,¹⁶⁹ and credit provisions related to AFVs that significantly increase their fuel economy for CAFE compliance purposes. Under the "standard setting" perspective, these technologies (pure battery electric vehicles and fuel cell vehicles¹⁷⁰) are not available in the compliance simulation to improve fuel economy. Under the "unconstrained" perspective, such as is documented in the Final SEIS, the CAFE Model considers these technologies in the same manner as other available technologies and may apply them if they represent cost-effective compliance pathways. However, under both perspectives, the analysis continues to include dedicated

AFVs that could be produced in response to CAFE standards outside the model years for which standards are being set, or for other reasons (e.g., ZEV mandates, as accounted for in this analysis).

EPCA also provides that CAFE levels may, subject to limitations, be adjusted upward to reflect the sale of flexible fuel vehicles (FFVs). Because these adjustments ended in MY 2020, this analysis assumes no manufacturer will earn FFV credits within the modeling horizon.

In contrast, the CAA allows consideration of alternative fuels, and EPA has provided that manufacturers selling PHEVs, BEVs, and FCVs may, when calculating fleet average CO₂ levels, "count" each unit of production as more than a single unit. The CAFE Model accounts for these "multipliers."

There were no natural gas vehicles in the baseline fleet, and the analysis did not apply natural gas technology due to cost effectiveness. The application of production multipliers for natural gas vehicles for MY 2022 would have no impact on the analysis because given the state of natural gas vehicle refueling infrastructure, the cost to equip vehicles with natural gas tanks, the outlook for petroleum prices, and the outlook for battery prices, we have little basis to project more than an inconsequential response to this incentive in the foreseeable future.

D. Technology Pathways, Effectiveness, and Cost

Vehicle manufacturers meet increasingly stringent fuel economy standards by applying additional fuel-economy-improving technologies to their vehicles. To assess what increases in fuel economy standards could be achievable at what cost, we first need accurate characterizations of fuel-economy-improving technologies. We collected data on over 50 fuel-economy-improving technologies that manufacturers could apply to their vehicles to meet future stringency levels. This includes determining technology effectiveness values, technology costs, and how we realistically expect manufacturers could apply the technologies in the rulemaking timeframe. The characterizations of these fuel-economy-improving technologies are built on work performed by DOT, EPA, NAS, and other Federal and state government agencies including the Department of Energy's Argonne National Laboratory and the California Air Resources Board.

In the NPRM we described spending approximately a decade refining the technology pathways, effectiveness, and

cost assumptions used in successive CAFE Model analyses. We discussed developing guiding principles to ensure the CAFE Model reasonably simulates manufacturers' possible real-world compliance behavior. These guiding principles are as follows:

The fuel economy improvement from any individual technology must be considered in conjunction with any other fuel-economy-improving technologies applied to the vehicle.

Certain technologies will have complementary or non-complementary interactions with the full vehicle technology system. For example, there is an obvious fuel economy benefit that results from converting a vehicle with a traditional internal combustion engine to a battery electric vehicle; however, the benefit of the electrification technology depends on the other road load reducing technologies (i.e., mass reduction, aerodynamic, and rolling resistance) on the vehicle.

Technologies added in combination to a vehicle will not result in a simply additive fuel economy improvement from each individual technology. As discussed in Section III.C.4, full vehicle modeling and simulation provides the required degree of accuracy to project how different technologies will interact in the vehicle system. For example, as discussed further in Sections III.D.1 and III.D.3, a parallel hybrid architecture powertrain improves fuel economy, in part, by allowing the internal combustion engine to spend more time operating at efficient engine speed and load conditions. This reduces the advantage of adding advanced internal combustion engine technologies, which also improve fuel economy, by broadening the range of speed and load conditions for the engine to operate at high efficiency. This redundancy in fuel savings mechanism results in a reduced effectiveness improvement when the technologies are added to each other.

The effectiveness of a technology depends on the type of vehicle the technology is being applied to. For example, applying mass reduction technology results in varying effectiveness as the absolute mass reduced is a function of the starting vehicle mass, which varies across vehicle technology classes. See Section III.D.4 for more details.

The cost and effectiveness values for each technology should be reasonably representative of what can be achieved across the entire industry. Each technology model employed in the analysis is designed to be representative of a wide range of specific technology applications used in industry. Some vehicle manufacturer's systems may

¹⁶⁹ 49 U.S.C. 32902(h).

¹⁷⁰ Dedicated compressed natural gas (CNG) vehicles should also be excluded in this perspective but are not considered as a compliance strategy under any perspective in this analysis.

perform better and cost less than our modeled systems and some may perform worse and cost more. However, employing this approach will ensure that, on balance, the analysis captures a reasonable level of costs and benefits that would result from any manufacturer applying the technology.

The baseline for cost and effectiveness values must be identified before assuming that a cost or effectiveness value could be employed for any individual technology. For example, as discussed further in Section III.D.1.d) below, this analysis uses a set of engine map models that were developed by starting with a small number of baseline engine configurations, and then, in a very systematic and controlled process, adding specific well-defined technologies to create a new map for each unique technology combination.

Historically, we have received comments concerned with specific technology assumptions, such as technology effectiveness or cost, or how we applied adoption features. In response to this proposal, however, commenters instead focused on broader portions of our modeling approach. Specifically, we received comments about the range of technologies considered on the advanced engine technology pathway and hybrid/electric pathway, considering the potential future of light duty vehicle fuel economy and greenhouse gas emissions regulations. We did still receive some comments regarding specific technology values, but fewer than previous rules.¹⁷¹

Vehicle manufacturers emphasized the diminishing returns to investing in advanced internal combustion engine technologies, and a current trend of shifting resources from ICE development into electrification technologies. Ford Motor Company (Ford) commented that “[t]he transformation of the light-duty fleet toward electrification will require unprecedented levels of ingenuity and investment to succeed. Over the last 10 years, rapid improvements in internal combustion engine (ICE) fuel efficiency and criteria emissions performance have been accomplished. Further improvements are possible, but will be marginal, and will come at high cost.”¹⁷² Similarly, Volkswagen Group of America (Volkswagen) commented that they have “publicly stated that investments into combustion

technologies will wane with a point in the next several years where there will be no new combustion engine families developed for the Group. Volkswagen recognizes that remaining combustion models will continue to be sold in high volume for the next several years and that it is important to preserve the fuel economy of remaining ICEs as electrification volumes increase. As noted earlier, Volkswagen’s remaining ICE engines will [sic] primary focus on evolutions of existing downsized, charged engines to incorporate incremental hardware and software improvements.”¹⁷³ Toyota Motor North America, Inc. (Toyota) also commented that “data has consistently documented that even advanced ICE-only powertrains will fall short of the proposed standards and that while future advancements are possible, a point of diminishing returns is in part driving the transition to electrified powertrains, including conventional hybrids.”¹⁷⁴

In contrast, Union of Concerned Scientists (UCS) acknowledged that “given automaker investments and future product plans, it is likely that manufacturers’ compliance strategies will include increased electrification. However, there are significant opportunities for improvements to internal combustion engine vehicles as well.”¹⁷⁵ Similarly, ICCT provided examples of vehicle technologies that can “boost ICE efficiency well beyond even HCR2 efficiency levels,” including technologies that are not modeled in the analysis like negative valve overlap (NVO) fuel reforming, passive prechamber engines, and high energy ignition systems.¹⁷⁶ Borg Warner also provided hydrogen combustion as “an advanced technology that has been under development for some time and could be more rapidly deployed in high volumes to make an impact.”¹⁷⁷

First and foremost, we want to emphasize that the purpose of this regulation is to set maximum feasible CAFE standards for passenger cars and light trucks that improve energy conservation, and not to advocate for specific technology solutions. We acknowledge that the industry is not going to quickly abandon ICE technologies and we anticipate

improvements in those vehicles for years to come; however, we also acknowledge that many manufacturers have announced significant shifts in product line-up, moving toward electrification technologies and likely slowing the rate of new ICE technology introduction.¹⁷⁸ That said, we agree with comments urging us to staying abreast of the feasibility of advanced engine and other powertrain technologies. For this analysis we evaluated over 50 different technologies for effectiveness and cost and continue to research the feasibility of additional technology models. However, we also agree with comments regarding constraining some advanced technology options as an acknowledgment of the realities of limited investment resources. Accordingly, we expect an actual pathway to compliance in the rulemaking timeframe to fall somewhere between the extremes suggested by the commenters above. This expectation is discussed further in the results/legal justification section¹⁷⁹ and in the engine technology section.¹⁸⁰

As a result, we believe the range of technologies modeled on the advanced engine technologies and hybrid/electric pathways appropriately represent the range of technologies that will be available in the rulemaking time frame. The technologies in our analysis are

¹⁷⁸ “Mercedes-Benz Prepares to Go All-Electric,” Mercedes-Benz Media Newsroom USA (Jul. 22, 2021), <https://media.mbusa.com/releases/release-ee5a810c1007117e79e1c871354679e4-mercedes-benz-prepares-to-go-all-electric> (accessed: February 16, 2022). “Investments into combustion engines and plug-in hybrid technologies will drop by 80% between 2019 and 2026.”; Hannah Lutz, “Shifting into E,” Automotive News (Jul. 26, 2021). “Some existing vehicles, such as the Chevy Malibu and Camaro, won’t stick to the standard cadence of face-lifts and redesigns. Instead, they’ll ride out the current generation before making way for EVs.” Jordyn Grzelewski, “Ford Slated to Spend More On EVs Than On Internal Combustion Engine Vehicles in 2023,” The Detroit News (Aug. 2, 2021).; Lindsay Chappell, “All-In On EVs,” Automotive News (May 17, 2021). “Mini will become an all-electric brand by early 2030, and the British marque will roll out its last new combustion engine variant in 2025.” (Emphasis added); Bibhu Pattnaik, “Audi Will Not Introduce ICE Vehicles After 2026, No Hybrid Vehicles Either,” Benzinger (Jun. 19, 2021), <https://finance.yahoo.com/news/audi-not-introduce-ice-vehicles-160320055.html> (accessed February 16, 2022); Mike Colias, “Gas Engines, and the People Behind Them, Are Cast Aside for Electric Vehicles,” The Wall Street Journal (Jul. 23, 2021). “Auto executives have concluded, to varying degrees, that they can’t meet tougher tailpipe-emission rules globally by continuing to improve gas or diesel engines . . . Over the past several decades, auto makers in most years rolled out between 20 and 70 new engines globally, according to research firm IHS Markit. That number will fall below 10 this year, and then essentially go to zero, the research firm said.”

¹⁷⁹ See Section VI.

¹⁸⁰ See Section III.D.1.

¹⁷³ Volkswagen, Docket No. NHTSA–2021–0053–1548–A1, at pp. 21–22.

¹⁷⁴ Toyota, Docket No. NHTSA–2021–0053–1568, at p. 2.

¹⁷⁵ UCS, Docket No. NHTSA–2021–0053–1567–A1, at p. 6.

¹⁷⁶ ICCT, Docket No. NHTSA–2021–0053–1581–A1, at p. 2.

¹⁷⁷ BorgWarner Inc. (BorgWarner), Docket No. NHTSA–2021–0053–1473, at p. 2.

¹⁷¹ Comments regarding specific technology modeling values, such as battery cost, strong hybrid electric vehicle costs, and high compression ratio engine adoption features are addressed under their respective paragraphs below.

¹⁷² Ford, Docket No. NHTSA–2021–0053–1545–A1, at p. 1.

based on guidance from NAS¹⁸¹ and align with technologies considered by the EPA as part of their final rulemaking for MYs 2023–2026.¹⁸²

However, the CAFE Model is a tool that offers many ways to evaluate a cost-effective technology pathway for vehicle manufacturers to reach given levels of CAFE standards, based on user-provided inputs and constraints. As a result of the concerns expressed in the comments above, we included a sensitivity analysis with inputs assuming that vehicle manufacturers would no longer deploy advanced engine technologies.¹⁸³ The sensitivity analysis demonstrates a technology path where manufacturers choose to stop applying additional ICE improvements and only invest in partial or full electrification technologies going forward.¹⁸⁴ Our “no advanced engines” sensitivity analysis shows a modest increase in strong hybrid (SHEV) and plug-in hybrid (PHEV) technology adoption compared to the reference analysis. This modest increase, about 5–6 percent increased technology penetration of SHEVs and PHEVs, enables the manufacturers to meet more stringent standards without the adoption of additional advanced ICE technology. The “no advanced engine” technology pathway increases the estimated average vehicle costs by \$25 over the reference analysis by MY 2029.¹⁸⁵

In consideration of comments received on the NPRM analysis and the results of additional sensitivity analysis, we believe that the technologies included in the CAFE Model’s technology tree are currently appropriate, and we have made no changes in the technology tree for the analysis supporting this final rule. We believe the selected technologies provide a realistic representation of options that manufacturers have to comply with standards in the rulemaking timeframe.

We made changes to just three technology inputs from the NPRM to this final rule. The changes are discussed in detail in the respective technology sections, and include:

- Decreased eCVT and cable costs associated with strong hybrid electric vehicle technologies;
- Decreased start/stop micro hybrid battery costs; and
- Correction of the high compression ratio with cylinder deactivations setting in the Technologies input file.

The following sections discuss the engine, transmission, electrification, mass reduction, aerodynamic, tire rolling resistance, and other vehicle technologies considered in this analysis. Each section discusses how we define the technology in the CAFE Model,¹⁸⁶ how we assign the technology to vehicles in the MY 2020 analysis fleet used as a starting point for this analysis, any adoption features that we apply to the technology so the analysis better represents manufacturers’ real-world decisions, the technology effectiveness values, and technology cost. In addition, each section discusses the comments received for that technology pathway, and the changes made to input values because of comments.

Please note that the following technology effectiveness sections provide *examples* of the *range* of effectiveness values that a technology could achieve when applied to the entire vehicle system, in conjunction with the other fuel-economy-improving technologies already in use on the vehicle.¹⁸⁷ To see the incremental effectiveness values for any particular vehicle moving from one technology key to a more advanced technology key, see the FE_1 and FE_2 Adjustments files that are integrated in the CAFE Model executable file. Similarly, the technology costs provided in each section are examples of absolute costs seen in specific model years (MYs 2020, 2025, and 2030 for most technologies), for specific vehicle classes.¹⁸⁸ Please refer to the Technologies file to see all absolute technology costs used in the analysis across all model years.

1. Engine Paths

We classified the extensive variety of light duty vehicle internal combustion (IC) engine technologies into discrete engine technology paths for this analysis. These engine technology paths model the most representative characteristics, costs, and performance

of the fuel-economy improving technologies likely available during the rulemaking time frame. It is our intent that the technology paths be representative of the range of potential performance levels for each of the technologies. We also acknowledge that some new and pre-production technologies are not part of this analysis because of uncertainties in the cost and capabilities of these emerging technologies. As a result, we did not include technologies unlikely to be feasible in the rulemaking timeframe, technologies unlikely to be compatible with U.S. fuels, or technologies where there were not appropriate data available to allow the simulation of effectiveness across all vehicle technology classes in this analysis.

We briefly discuss IC engine technologies considered in this analysis, the CAFE Model’s general engine technology categories, and how we assign engine technologies in the analysis fleet in the following sections. We also touch on engine technologies’ adoption features, costs, and effectiveness when used as part of a full vehicle model. For a complete discussion on all of these topics please see the TSD.¹⁸⁹

(a) Engine Modeling in the CAFE Model

Engine modeling in the CAFE Model involves the application of internal combustion engine technologies that manufacturers use to improve fuel economy. Of the engine technologies we model, some can be incorporated into existing engines with minor or moderate changes, but many require an entirely new engine architecture. As a result, we divide engine technologies into two categories, “basic engine technologies” and “advanced engine technologies.” “Basic engine technologies” refer to technologies adaptable to an existing engine with minor or moderate changes to the engine. “Advanced engine technologies” refer to technologies that generally require significant changes or an entirely new engine architecture.

We do not intend for the words “basic” and “advanced” to confer any information about the level of sophistication of the technology or to indicate relative cost. Many advanced engine technology definitions include some basic engine technologies in their design, and these basic technologies are accounted for in the costs and effectiveness values of the advanced engine. Figure III–7 shows how we organize the engine technologies pathways evaluated in the compliance simulation. We briefly describe each

¹⁸¹ 2021 NAS Report.

¹⁸² For detailed discussions on all the technologies used in this analysis see TSD Chapter 3, For more detailed discussion of the comments discussed here see Section III.D.1.

¹⁸³ See TSD Chapter 3.1 for a definition of advanced engine technologies.

¹⁸⁴ See FRIA Chapter 7.1 for more details; the sensitivity case “conv-tech-imprlimited” is referred to as “no advanced engine” in this discussion.

¹⁸⁵ Effects of standards on the fleet out to MY 2029 are considered to account for years the regulation covers, and years of potential carry back credit use.

¹⁸⁶ Note, due to the diversity of definitions industry uses for technology terms, or in describing the specific application of technology, the terms defined here may differ from how the technology is defined in the industry.

¹⁸⁷ This serves as a visual example of the conditional effectiveness of adding ‘one technology at a time’ discussed in the guiding principles above.

¹⁸⁸ The values shown serve as examples of cost origins and how cost values were treated to account for changes due to learning or time value of money.

¹⁸⁹ See TSD Chapter 3.1.

engine technology below. It is important to note the “Basic Engine Path” shows

that every engine starts with VVT and can add one, some, or all of the

technologies in the dotted box, as discussed in Section III.D.1.a)(1).

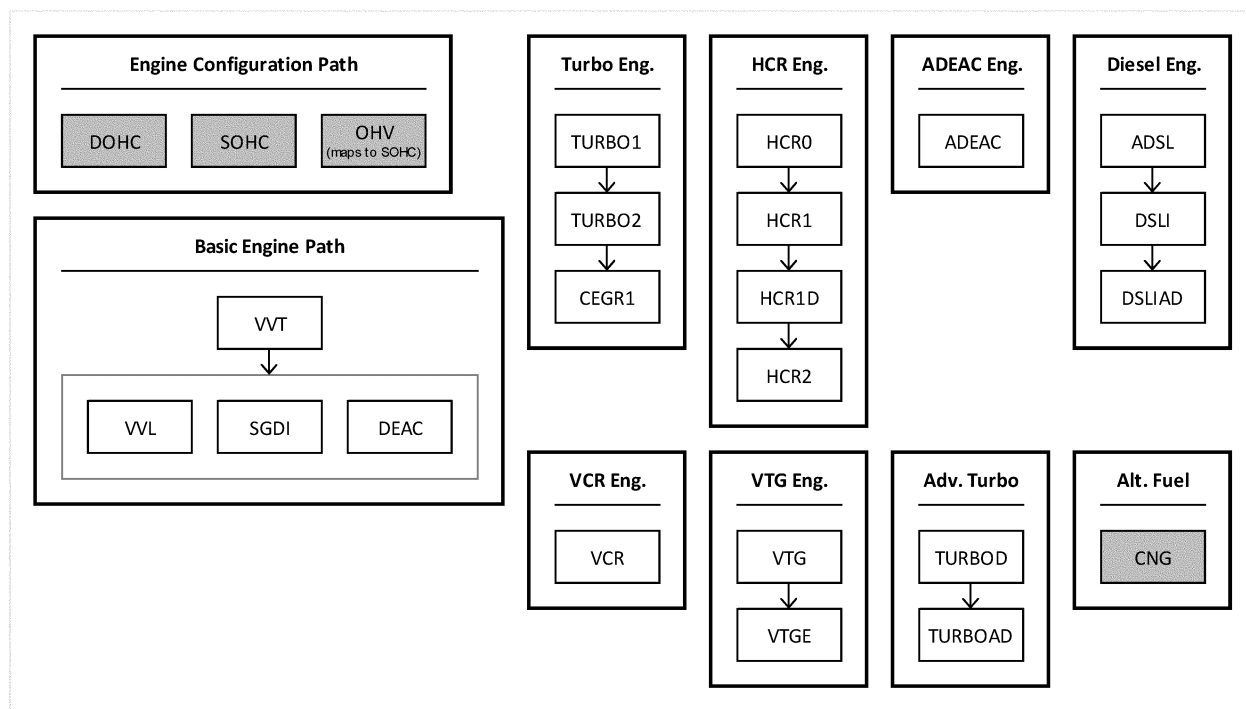

Figure III-7 – Engine Technology Paths in the CAFE Model

In response to our proposal, some commenters, particularly in the automotive industry, commented in support of the number of advanced engine technologies in the engine tree especially in light of forthcoming electrification investments. Other commenters, in particular some environmental groups, commented with examples of advanced engine technologies that they believed we should consider in the analysis.

More specifically, the automotive industry believes that the future of ICE technology is very limited, as manufacturers turn their focus to the electrification of the fleet. The new focus would result in limitation or even removal of resources dedicated to further ICE development. Major manufacturers provided information indicating that they will not develop advanced engine technologies beyond the current generation. Commenters who provided information suggesting engine technology may stagnate as manufacturers dedicate resources to electrification technology included Ford, Toyota, Volkswagen, and the Auto Innovators.

Ford stated:

Over the last 10 years, rapid improvements in internal combustion engine (ICE) fuel efficiency and criteria emissions performance

have been accomplished. Further improvements are possible, but will be marginal, and will come at high cost. Ford requests that the agencies carefully weigh these considerations in the current and future rulemakings to ensure that resources and investment are not diverted from our primary objective: Fulfilling President Biden’s goal of achieving 40–50 [percent] ZEV sales by 2030.¹⁹⁰

Toyota stated:

Toyota has provided extensive information, in public comments and under CBI, on the effectiveness of [CO₂] reduction technologies including those for advanced gasoline engines.¹⁹¹ The data has

¹⁹⁰ Ford, Docket No. NHTSA–2021–0053–1545–A1, at p. 1.

¹⁹¹ Toyota comments on: Draft Technical Assessment Report on 2022–2025 Model Year Light-Duty Vehicle Greenhouse Gas Emission Standards and Corporate Average Fuel Economy Standards, EPA–420–D–16–900 pp. 2–5 and Appendix 1; Proposed Determination on the Appropriateness of the Model Year 2022–2025 Light-Duty Vehicle Greenhouse Gas Emissions Standards under the Midterm Evaluation, EPA–420–R–16–020, pp. 3–8; Request for Comment on Reconsideration of the Final Determination of the Mid-Term Evaluation of Greenhouse Gas Emissions Standards for Model Year 2022–2025 Light-Duty Vehicles; Request for Comment on Model Year 2021 Greenhouse Gas Emissions Standards, EPA–HQ–OAR–2015–0827, pp. 3–9; Safer Affordable Fuel-Efficient (SAFE) Vehicles Rule For Model Years 2020–2026 Model Year Passenger Cars and Light Trucks, NHTSA–2018–0067; EPA–HQ–OAR–2018–0283, pp. 2–9 and Appendices A–C.

consistently documented that even advanced ICE-only powertrains will fall short of the proposed standards and that while future advancements are possible, a point of diminishing returns is in part driving the transition to electrified powertrains, including conventional hybrids. EPA notes manufacturer plans and announcements of “a rapidly growing shift in investment away from internal-combustion technologies and toward high levels of electrification.”^{192 193}

Volkswagen stated:

As noted earlier, Volkswagen has implemented a capital spending plan and technology roadmap that primary focuses on electrification as our main pathway for achieving deep decarbonization and petroleum reduction goals. In parallel with increasing consumer demand for electrification, the increase in States with ZEV mandates and the emergence and recent passage of State legislation banning combustion, it is unlikely that OEMs will invest significant resources in researching new combustion technologies or developing all new powertrains.

Engine development programs are long-lead time, often requiring 5 years to fully design and validate new engines. Powertrain production is also capital intensive, and the

¹⁹² U.S. EPA. Revised 2023 and Later Model Year Light-Duty Vehicle GHG Emissions Standards, EPA–HQ–OAR–2021–0208, August 2021, at p. 43766.

¹⁹³ Toyota, Docket No. NHTSA–2021–0053–1568, at p. 2.

high upfront costs often consider 10 plus years of steady volume to amortize the production and development costs. The effects have been studied extensively by NHTSA and the National Academies and are reflected in such factors as Retail Price Equivalency (RPE) values. However, with the shift to legislative and regulatory programs that are reducing and eliminating future market volumes for combustion technologies, it is unlikely that OEMs will make significant investments in this space.

Volkswagen has publicly stated that investments into combustion technologies will wane with a point in the next several years where there will be no new combustion engine families developed for the Group. Volkswagen recognizes that remaining combustion models will continue to be sold in high volume for the next several years and that it is important to preserve the fuel economy of remaining ICEs as electrification volumes increase. As noted earlier, Volkswagen's remaining ICE engines will primarily focus on evolutions of existing downsized, charged engines to incorporate incremental hardware and software improvements.¹⁹⁴

Auto Innovators stated:

Manufacturers are also already announcing plans to reduce or eliminate investments in ICEs. Some automotive executives are saying that they no longer intend to develop new ICEs, are no longer setting aside significant money for new ICEs, or that ICEs will only get incremental work. Others, such as policymakers, may suggest that little or no investment is needed in ICE technologies because they are "off-the-shelf" or present in the fleet today. This view ignores that technologies can't simply be "bolted on" to existing engines. Instead, they must be carefully integrated into existing designs, requiring engineering resources, and in many cases, new engine designs. A new engine design can cost as much as \$1 billion.¹⁹⁵

¹⁹⁴ Volkswagen, Docket No. NHTSA–2021–0053–1548–A1, at pp. 21–22.

¹⁹⁵ Auto Innovators, Docket No. NHTSA–2021–0053–0021–A1, at 8 (citing "Mercedes-Benz Prepares to Go All-Electric," Mercedes-Benz Media Newsroom USA (Jul. 22, 2021), <https://media.mbusa.com/releases/release-ee5a810c1007117e79e1c871354679e4-mercedes-benz-prepares-to-go-all-electric> (accessed: February 16, 2022)). "Investments into combustion engines and plug-in hybrid technologies will drop by 80% between 2019 and 2026."; Hannah Lutz, "Shifting into E," Automotive News (Jul. 26, 2021). "Some existing vehicles, such as the Chevy Malibu and Camaro, won't stick to the standard cadence of facelifts and redesigns. Instead, they'll ride out the current generation before making way for EVs."; Jordyn Grzelewski, "Ford Slated to Spend More On EVs Than On Internal Combustion Engine Vehicles in 2023," The Detroit News (Aug. 2, 2021); Lindsay Chappell, "All-In On EVs," Automotive News (May 17, 2021). "Mini will become an all-electric brand by early 2030, and the British marque will roll out its last new combustion engine variant in 2025." (Emphasis added.); Bibhu Pattnaik, "Audi Will Not Introduce ICE Vehicles After 2026, No Hybrid Vehicles Either," Benzinger (Jun. 19, 2021), <https://finance.yahoo.com/news/audi-not-introduce-ice-vehicles-160320055.html> (accessed: February 16, 2022), Mike Colias, "Gas Engines, and the People Behind Them, Are Cast Aside for Electric

These comments reflect an increasing industry trend to divest from internal combustion engine technology, to increase investments in alternative powertrains such as electrification or fuel cells. The provided comments also support NAS's finding: ICE technology advancements are seeing diminishing returns, with future gains requiring significant investment, driving manufacturers to alternative technology development in place of further ICE development, such as electrification.¹⁹⁶

On the other hand, some commenters were concerned that our modeled technology paths do not adequately keep pace with potential significant improvements in ICE technologies that manufacturers will continue to make. ICCT and UCS suggested that additional advanced versions of modeled technologies as well as additional technologies should be added to the engine technology paths. Both commenters provided information on emerging technologies currently in the research phase, and the commenters stated these new technologies should be included in the engine technology path options.

ICCT stated, "two recent reports demonstrate that further technology improvements are coming that can boost ICE efficiency well beyond even HCR2 efficiency levels."¹⁹⁷ ICCT further stated, "Indeed, it appears that no technology improvements or cost reductions from EPA's independent evaluations or from any comments submitted to NHTSA or new studies over the last 5 years were included in the proposed rule, beyond the additional of DEAC to HCR1. This basis for NHTSA's analysis is an overly conservative assessment of the costs of the standards."

UCS also provided a comment suggesting the need for more advanced engine technology models:

Given automaker investments and future product plans, it is likely that manufacturers'

Vehicles," The Wall Street Journal (Jul. 23, 2021). "Auto executives have concluded, to varying degrees, that they can't meet tougher tailpipe-emission rules globally by continuing to improve gas or diesel engines . . . Over the past several decades, auto makers in most years rolled out between 20 and 70 new engines globally, according to research firm IHS Markit. That number will fall below 10 this year, and then essentially go to zero, the research firm said."

¹⁹⁶ 2021 NAS Report, Finding 4.7, at p. 70.

¹⁹⁷ ICCT, Docket No. NHTSA–2021–0053–1581–A1, at 2 (citing AVL Webinar on Passenger Car powertrain 4.x—Fuel Consumption, Emissions, and Cost on June 2, 2020 <https://www.avl.com/-/passenger-car-powertrain-4.x-fuel-consumption-emissions-and-cost> plus slides are attached to these comments (AVL 2020); Roush report on Gasoline Engine Technologies for Improved Efficiency (Roush 2021 LDV) <https://www.regulations.gov/comment/EPA-HQ-OAR-2021-0208-0210>).

compliance strategies will include increased electrification. However, there are significant opportunities for improvements to internal combustion engine vehicles as well. The importance of both strategies is evident in our own modeling. Internal combustion engine vehicles will continue to improve in the timeframe considered under this rule and show no sign of exhausting their potential. While our modeling suggests that manufacturers will deploy a significant number of EVs due to the improvement they can make in a fleet's performance, this is by no means the only path available, as indicated by the relatively low levels of vehicle technology modeled as being deployed in the remaining gasoline-powered fleet, which leave many other options open.¹⁹⁸

For this final rule analysis, the agency has made no changes to the Engine technology pathway.¹⁹⁹ While we agree with the potential of the technologies as they are described in the provided comments,²⁰⁰ we do not believe that the application of the technologies is feasible in the rulemaking timeframe. As stated in the NPRM and discussed above, we did not include technologies unlikely to be feasible in the rulemaking timeframe, technologies unlikely to be compatible with U.S. fuels, or technologies for which there were not appropriate data available to allow the simulation of effectiveness across all vehicle technology classes used in the analysis. For example, ICCT recommended the inclusion of passive prechamber combustion in our analysis. Currently, the technology is under development by two vendors, but neither vendor has indicated the system has progressed past the technology demonstration phase, or the technology is currently only used for specialty purposes.^{201 202}

In light of the comments provided by manufacturers, such as Volkswagen's comment above, it is very unlikely that major manufacturers will introduce these technologies in the time frame of the regulation.^{203 204} We also believe this

¹⁹⁸ UCS, Docket No. NHTSA–2021–0053–1567–A1, at 6 (citing Murphy, John. 2021. "US Automotive Product Pipeline: Car Wars 2022–2025 (Electric Vehicles shock the product pipeline)." Media briefing, June 10, 2021, on behalf of Bank of America Securities. <https://s3-prod.autonews.com/2021-06/BofA%20Global%20Research%20Car%20Wars.pdf>).

¹⁹⁹ See TSD Chapter 3.1 for a detailed discussion of the engine technology pathways used in the final rule analysis.

²⁰⁰ ICCT comments at pp. 8–10.

²⁰¹ <https://www.iav.com/en/what-moves-us-pre-chamber-ignition-small-spark-great-effect/>—Accessed 10DEC2021.

²⁰² <https://www.mahle-powertrain.com/en/experience/mahle-jet-ignition/>—Accessed 10DEC2021.

²⁰³ Volkswagen, at 21–22 ("Engine development programs are long-lead time, often requiring 5 years to fully design and validate new engines.

approach is in agreement with the assessments on ICE technologies provided by NAS, discussed above.²⁰⁵

(1) Basic Engines

We applied basic engine technologies individually or in combination with other basic engine technologies in the CAFE Model. The basic engine technologies we used include variable valve timing (VVT), variable valve lift (VVL), stoichiometric gasoline direct injection (SGDI), and cylinder deactivation. The cylinder deactivation technologies we used includes a basic level (DEAC) and an advanced level (ADEAC). DOT applies the basic engine technologies across two engine architectures: Dual over-head camshaft (DOHC) engine architecture and single over-head camshaft (SOHC) engine architecture.

VVT: Variable valve timing is a family of valve-train designs that dynamically adjusts the timing of the intake valves, exhaust valves, or both, in relation to piston position. VVT can reduce pumping losses, provide increased engine torque and horsepower over a broad engine operating range, and allow unique operating modes, such as Atkinson cycle operation, to further enhance efficiency.²⁰⁶ VVT is nearly universally used in the MY 2020 fleet. VVT enables more control of in-cylinder air flow for exhaust scavenging and combustion relative to fixed valve timing engines. Engine parameters such as volumetric efficiency, effective

Powertrain production is also capital intensive and the high upfront costs often consider 10 plus years of steady volume to amortize the production and development costs.”).

²⁰⁴ Auto Innovators, at 8 (“Others, such as policymakers, may suggest that little or no investment is needed in ICE technologies because they are “off-the-shelf” or present in the fleet today. This view ignores that technologies can’t simply be “bolted on” to existing engines. Instead, they must be carefully integrated into existing designs, requiring engineering resources, and in many cases, new engine designs. A new engine design can cost as much as \$1 billion.”).

²⁰⁵ 2021 NAS Report, at 369 (“Internal combustion engines (ICEs) will continue to play a significant role in the new vehicle fleet in MY 2025–2035 in ICE-only vehicles, as well as in hybrid electric vehicles (HEVs) from mild hybrids to plug-in hybrids, but will decrease in number with increasing battery electric vehicle (BEV) and fuel cell electric vehicle penetration. In this period, manufacturers will continue to develop and deploy technologies to further improve the efficiency of conventional powertrains, for ICE-only vehicles and as implemented in HEVs. Developments in the ICE for hybrids will advance toward engines optimized for a limited range of engine operating conditions, with associated efficiency benefits. Major automakers are on differing paths, with some focusing their research and development and advanced technology deployment more squarely on BEVs, and others more focused on advanced HEVs to maximize ICE efficiency.”).

²⁰⁶ 2015 NAS Report, at p. 31.

compression ratio, and internal exhaust gas recirculation (iEGR) can all be enabled and controlled by a VVT system.

VVL: Variable valve lift dynamically adjusts the distance a valve travels from the valve seat. The dynamic adjustment can optimize airflow over a broad range of engine operating conditions. The technology can increase effectiveness by reducing pumping losses and by affecting the fuel and air mixture motion and combustion in-cylinder.²⁰⁷ VVL is less common in the MY 2020 fleet than VVT, but still prevalent. Some manufacturers have implemented a limited, discrete approach to VVL. The discrete approach allows only limited (e.g., two) valve lift profiles versus allowing a continuous range of lift profiles.

SGDI: Stoichiometric gasoline direct injection sprays fuel at high pressure directly into the combustion chamber, which provides cooling of the in-cylinder charge via in-cylinder fuel vaporization to improve spark knock tolerance and enable an increase in compression ratio and/or more optimal spark timing for improved efficiency.²⁰⁸ SGDI is common in the MY 2020 fleet, and the technology is used in many advanced engines as well.

DEAC: Basic cylinder deactivation disables intake and exhaust valves and turns off fuel injection for the deactivated cylinders during light load operation. DEAC is characterized by a small number of discrete operating configurations.²⁰⁹ The engine runs temporarily as though it were a smaller engine, reducing pumping losses and improving efficiency. DEAC is present in the MY 2020 baseline fleet.

ADEAC: Advanced cylinder deactivation systems, also known as rolling or dynamic cylinder deactivation systems, allow a further degree of cylinder deactivation than the base DEAC. ADEAC allows the engine to vary the percentage of cylinders deactivated and the sequence in which cylinders are deactivated, essentially providing “displacement on demand” for low load operations. A small number of vehicles have ADEAC in the MY 2020 baseline fleet.

Section III.D.1.d) contains additional information about each basic engine technology used in this analysis, including information about the engine map models used in the full vehicle technology effectiveness modeling.

²⁰⁷ 2015 NAS Report, at p. 32.

²⁰⁸ 2015 NAS Report, at p. 34.

²⁰⁹ 2015 NAS Report, at p. 33.

(2) Advanced Engines

We define advanced engine technologies in the analysis as technologies that require significant changes in engine structure, or an entirely new engine architecture.²¹⁰ Currently there are two types of advanced engine technologies, the application of alternate combustion cycles or application of forced induction to the engine. Each advanced engine technology has a discrete pathway for progression to improved versions of the technology, as seen above in Figure III–7. The advanced engine technology pathways include a turbocharged pathway, a high compression ratio (Atkinson) engine pathway, a variable turbo geometry (Miller Cycle) engine pathway, a variable compression ratio pathway, and a diesel engine pathway. Although the CAFE Model includes a compressed natural gas (CNG) pathway, that technology is a baseline-only technology and was not included in the analysis; there are no dedicated CNG vehicles in the MY 2020 analysis fleet.

TURBO: Forced induction engines, or turbocharged downsized engines, are characterized by technology that can create greater-than-atmospheric pressure in the engine intake manifold when higher output is needed. The raised pressure results in an increased amount of airflow into the cylinder supporting combustion, increasing the specific power of the engine. Increased specific power means the engine can generate more power per unit of cylinder volume. The higher power per cylinder volume allows the overall engine volume to be reduced, while maintaining performance. The overall engine volume decrease results in an increase in fuel efficiency by reducing parasitic loads associated with larger engine volumes.²¹¹

Cooled exhaust gas recirculation is also part of the advanced forced induction technology path. The basic recycling of exhaust gases using VVT is called internal EGR (iEGR) and is included as part of the performance improvements provided by the VVT basic engine technology. Cooled EGR (cEGR) is a second method for diluting the incoming air that takes exhaust gases, passes them through a heat exchanger to reduce their temperature, and then mixes them with incoming air in the intake manifold.²¹² As discussed

²¹⁰ Examples of this include but are not limited to changes in cylinder count, block geometry or combustion cycle changes.

²¹¹ 2015 NAS Report, at p. 34.

²¹² 2015 NAS Report, at p. 35.

in Section III.D.1.d), many advanced engine maps include EGR.

Five levels of turbocharged engine downsizing technologies are considered in this analysis: A 'basic' level of turbocharged downsized technology (TURBO1), an advanced turbocharged downsized technology (TURBO2), an advanced turbocharged downsized technology with cooled exhaust gas recirculation applied (cEGR), a turbocharged downsized technology with basic cylinder deactivation applied (TURBOD), and a turbocharged downsized technology with advanced cylinder deactivation applied (TURBOAD).

HCR: Atkinson engines, or high compression ratio engines, represent a class of engines that achieve a higher level of fuel efficiency by implementing an alternate combustion cycle.²¹³ Historically, the Otto combustion cycle has been used by most gasoline-based spark ignition engines. Increased research into improving fuel economy has resulted in the application of alternate combustion cycles that allow for greater levels of thermal efficiency. One such alternative combustion cycle is the Atkinson cycle. Atkinson cycle operation is achieved by allowing the expansion stroke of the engine to overextend, allowing the combustion products to achieve the lowest possible pressure before the exhaust stroke.^{214 215 216}

Descriptions of Atkinson cycle engines and Atkinson mode or Atkinson-enabled engine technologies have been used interchangeably in association with high compression ratio (HCR) engines, for past rulemaking analyses. Both technologies achieve a higher thermal efficiency than traditional Otto cycle-only engines, however, the two engine types operate differently. For purposes of this analysis, Atkinson technologies can be categorized into two groups to reduce confusion: (1) Atkinson-enabled engines and (2) Atkinson engines.

Atkinson-enabled engines, or high compression ratio (HCR) engines, dynamically swing between an Otto

cycle like behavior (very little expansion over-stroke) to a more Atkinson cycle intensive behavior (large expansion over-stroke) based on engine demand. During high loads the engine will reduce the Atkinson level behavior by increasing the dynamic compression ratio, reducing over-stroke, sacrificing efficiency for increased power density. While at low loads the engine will increase the Atkinson level behavior by reducing the dynamic compression ratio, increasing the over-stroke, improve efficiency but reduce power density. The hybrid combustion cycle can be used to address, but not eliminate, the low power density issues that can constrain the application of an Atkinson-only engine and allow for a wider application of the technology.

The level of efficiency improvement experienced by a vehicle employing an Atkinson-enabled engine is directly related to how much of the engine's operation time is spent at high Atkinson levels. Vehicles that must maintain a high level of torque reserve, that experience operation at a high load for long portions of their operating cycle, or that have high base road loads, will see little to no benefit from this technology compared with other advanced engine technologies. This power density constraint results in manufacturers typically limiting the application of this technology to vehicles with a lower road load, and lower relative need for torque reserves.

Three HCR or Atkinson-enabled engines are available in the analysis: (1) The baseline Atkinson-enabled engine (HCR0), (2) the enhanced Atkinson enabled engine (HCR1), and finally, (3) the enhanced Atkinson enabled engine with cylinder deactivation (HCR1D).

Next, Atkinson engines (as opposed to Atkinson-enabled engines, discussed above) in this analysis are defined as engines that operate full-time in Atkinson cycle. The most common method of achieving Atkinson operation is the use of late intake valve closing. This method allows backflow from the combustion chamber into the intake manifold, reducing the dynamic compression ratio, and providing a higher over-expansion ratio during the expansion stroke. The higher expansion ratio improves thermal efficiency but reduces power density. The low power density relegates these engines to hybrid vehicle (SHEVPS) applications only in this analysis. Coupling the engines to electric motors and significantly reducing road loads compensates for the lower power density and maintains desired performance levels for the

vehicle.²¹⁷ The Toyota Prius is an example of a vehicle that uses an Atkinson engine. The 2017 Toyota Prius achieved a peak thermal efficiency of 40 percent.²¹⁸

VTG: The Miller cycle is another type of overexpansion combustion cycle, similar to the Atkinson cycle. The Miller cycle, however, operates in combination with a forced induction system that helps address the impacts of reduced power density during high load operating conditions. Miller cycle-enabled engines use a similar technology approach as seen in Atkinson-enabled engines to effectively create an expanded expansion stroke of the combustion cycle.

In the analysis, the baseline Miller cycle-enabled engine includes the application of a variable turbo geometry technology (VTG). The advanced Miller cycle enabled system includes the application of a 48V-based electronic boost system (VTGE). VTG technology allows the system to vary boost level based on engine operational needs. The use of a variable geometry turbocharger also supports the use of cooled exhaust gas recirculation.²¹⁹ An electronic boost system has an electric motor added to assist a turbocharger at low engine speeds. The motor assist mitigates turbocharger lag and low boost pressure at low engine speeds. The electronic assist system can provide extra boost needed to overcome the torque deficits at low engine speeds.²²⁰

ICCT provided comments regarding Miller Cycle technology as part of its comments about technologies that may not have been incorporated in NHTSA's proposal, stating that, "VW is already using Miller Cycle engines as the base engine in the Passat, Arteon, Atlas, and Tiguan and a hybrid-specific version of this engine with cEGR and VGT is under development by VW that demonstrates a peak BTE of 41.5 percent. The fact that Miller cycle is already included on the standard engine for many of VW's most popular vehicles supports that Miller cycle is a cost-effective addition to turbocharged engines. Yet there are no Miller cycle applications in 2026 beyond the specific Mazda and Volvo models that already had Miller cycle in 2017."²²¹

²¹³ See the 2015 NAS Report, Appendix D, for a short discussion on thermodynamic engine cycles.

²¹⁴ Otto cycle is a four-stroke cycle that has four piston movements over two engine revolutions for each cycle. First stroke: Intake or induction; second stroke: Compression; third stroke: Expansion or power stroke; and finally, fourth stroke: Exhaust.

²¹⁵ Compression ratio is the ratio of the maximum to minimum volume in the cylinder of an internal combustion engine.

²¹⁶ Expansion ratio is the ratio of maximum to minimum volume in the cylinder of an IC engine when the valves are closed (*i.e.*, the piston is traveling from top to bottom to produce work).

²¹⁷ Toyota. "Under the Hood of the All-new Toyota Prius." Oct. 13, 2015. Available at <https://global.toyota/en/detail/9827044>. (Accessed: February 17, 2022)

²¹⁸ Matsuo, S., Ikeda, E., Ito, Y., and Nishiura, H., "The New Toyota Inline 4 Cylinder 1.8L ESTEC 2ZR-FXE Gasoline Engine for Hybrid Car," SAE Technical Paper 2016-01-0684, 2016, <https://doi.org/10.4271/2016-01-0684>.

²¹⁹ 2015 NAS Report, at p. 116.

²²⁰ 2015 NAS Report, at p. 62.

²²¹ ICCT, at p. 4.

NHTSA's NPRM used a MY 2020 fleet that appropriately characterized Volkswagen, Volvo, and Mazda engines with VTG and VTGe technology.²²² We believe our use of the MY 2020 baseline fleet addresses some of the concerns expressed by ICCT. As far as additional application of the technology in the MY 2026 fleet results, we did not place any adoption restrictions on the use of VTG and VTGe technology and it can be applied to any basic and turbocharged engine. This means that while VTG and VTGe may be a cost-effective technology for some manufacturers in the real world—particularly for Volkswagen, a manufacturer that already has the technology refined for use on its vehicles—the CAFE Model did not consider it to be a cost-effective pathway to compliance for manufacturers in the analysis, that did not already use the technology in MY 2020. NHTSA does not have any alternative relative effectiveness²²³ data or cost estimates to consider that would affect the CAFE Model's compliance pathway. Therefore, we have made no changes to this engine technology's inputs in the final rule analysis from what was used in the NPRM. We will continue to follow any updates on the effectiveness and cost of VTG and VTGe technology for future actions.

VCR: Variable compression ratio (VCR) engines work by changing the length of the piston stroke of the engine to optimize the compression ratio and improve thermal efficiency over the full range of engine operating conditions. Engines using VCR technology are currently in production, but appear to be targeted primarily towards limited production, high performance applications. Nissan is the only manufacturer to use this technology in the MY 2020 baseline fleet. Few manufacturers and suppliers provided information about VCR technologies, and we reviewed several design concepts that could achieve a similar functional outcome. In addition to design concept differences, intellectual property ownership complicates the

ability to define a VCR hardware system that could be widely adopted across the industry. Because of these issues, adoption of the VCR engine technology is limited to specific OEMs only.

ADSL: Diesel engines have several characteristics that result in superior fuel efficiency over traditional gasoline engines. These advantages include reduced pumping losses due to lack of (or greatly reduced) throttling, high pressure direct injection of fuel, a more efficient combustion cycle,²²⁴ and a very lean air/fuel mixture relative to an equivalent-performance gasoline engine.²²⁵ However, diesel technologies require additional enablers, such as a NO_x adsorption catalyst system or a urea/ammonia selective catalytic reduction system, for control of NO_x emissions.

DOT considered three levels of diesel engine technology: The baseline diesel engine technology (ADSL) is based on a standard 2.2L turbocharged diesel engine; the more advanced diesel engine (DSL) starts with the ADSL system and incorporates a combination of low pressure and high pressure EGR, reduced parasitic loss, friction reduction, a highly integrated exhaust catalyst with low temp light off temperatures, and closed loop combustion control; and finally the most advanced diesel system (DSLAD) is the DSL system with advanced cylinder deactivation technology added.

EFR: Engine friction reduction technology is a general engine improvement meant to represent future technologies that reduce the internal friction of an engine. EFR technology is not available for application until MY 2023. The future technologies do not significantly change the function or operation of the engine but reduce the energy loss due to the rotational or rubbing friction experienced in the bearings or cylinder during normal operation. These technologies can include improved surface coatings, lower-tension piston rings, roller cam followers, optimal thermal management and piston surface treatments, improved bearing design, reduced inertial loads,

improved materials, or improved geometry.

(b) Engine Analysis Fleet Assignments

As a first step in assigning baseline levels of engine technologies in the analysis fleet, DOT uses data for each manufacturer to determine which platforms share engines. Within each manufacturer's fleet, DOT assigns unique identification designations (engine codes) based on configuration, technologies applied, displacement, compression ratio, and power output. DOT uses power output to distinguish between engines that might have the same displacement and configuration but significantly different horsepower ratings.

The CAFE Model identifies leaders and followers for a manufacturer's vehicles that use the same engine, indicated by sharing the same engine code. The model automatically determines which engines are leaders by using the highest sales volume row of the highest sales volume nameplate that is assigned an engine code. This leader-follower relationship allows the CAFE Model simulation to maintain engine sharing as more technology is applied to engines.

DOT accurately represents each engine using engine technologies and engine technology classes. The first step is to assign engine technologies to each engine code. Technology assignment is based on the identified characteristics of the engine being modeled, and based on technologies assigned, the engine will be aligned with a technology key that most closely corresponds.

The engine technology classes are a second identifier used to accurately account for engine costs. The engine technology class is formatted as number of cylinders followed by the letter C, number of banks followed by the letter B, and an engine head configuration designator, which is _SOHC for single overhead cam, _ohv for overhead valve, or blank for dual overhead cam. As an example, one variant of the GMC Acadia has a naturally aspirated DOHC inline 4-cylinder engine, so DOT assigned the vehicle to the '4C1B' engine technology class and assigned the technology VVT and SGDI. Table III-7 shows examples of observed engines with their corresponding assigned engine technologies as well as engine technology classes.

²²² See Section III.C.2, The Market Data File.

²²³ As a reminder, our analysis considers the relative technology effectiveness improvement from a previously applied technology. Therefore, while VW may be developing a hybrid version of its Miller engine technology with a peak BTE of 41.5 percent, the relevant data point for our analysis would be the relative effectiveness improvement from the previous version of the technology.

²²⁴ Diesel cycle is also a four-stroke cycle like the Otto Cycle, except in the intake stroke no fuel is injected and fuel is injected late in the compression stroke at higher pressure and temperature.

²²⁵ See the 2015 NAS Report, Appendix D, for a short discussion on thermodynamic engine cycles.

Table III-7 – Examples of Observed Engines and Their Corresponding Engine Technology Class and Technology Assignments

Vehicle	Engine Observed	Engine Technology Class Assigned	Engine Technology Assigned
GMC Acadia	Naturally Aspirated DOHC Inline 4 cylinder	4C1B	VVT, SGDI
VW Arteon	Turbocharged DOHC Inline 4 cylinder	6C2B	TURBO1
Bentley Bentayga	Turbocharged DOHC W12 w/ cylinder deactivation	16C4B	TURBOD
Honda Passport	Naturally Aspirated SOHC V6	6C2B_SOHC	VVT, VVL, SGDI, DEAC
Honda Civic	Turbocharged DOHC Inline 4 cylinder	4C1B	TURBO1
Cadillac CT5	Turbocharged DOHC V6 w/ cylinder deactivation	8C2B	TURBOD
Ford Escape	Turbocharged DOHC Inline 3 cylinder	4C1B_L	TURBO1
Chevrolet Silverado	Naturally Aspirated OHV V8 w/ skip fire	8C2B_ohv	ADEAC

The cost tables for a given engine class include downsizing (to an engine architecture with fewer cylinders) when turbocharging technology is applied, and therefore, the turbocharged engines observed in the 2020 fleet (that have already been downsized) often map to an engine class with more cylinders. For instance, an observed TURBO1 V6 engine would map to an 8C2B (V8) engine class, because the turbo costs on the 8C2B engine class worksheet assume a V6 (6C2B) engine architecture. Diesel engines map to engine technology classes that match the observed cylinder count since naturally aspirated diesel engines are not found in new light duty vehicles in the U.S. market. Similarly,

as indicated above, the TURBO1 I3 in the Ford Escape maps to the 4C1B_L (I4) engine class, because the turbo costs on the 4C1B_L engine class worksheet assume a I3 (3C1B) engine architecture. Some instances can be more complex, including low horsepower variants for 4 cylinder engines, and are shown in Table III–8.

For this analysis, we allow additional downsizing beyond what has been previously modeled in prior rulemaking analyses. We allow enhanced downsizing because manufacturers have downsized low output naturally aspirated engines to turbo engines with smaller architectures than traditionally observed.^{226 227 228} To capture this new level of turbo downsizing we created a

new category of low output naturally aspirated engines, which is only applied to 4-cylinder engines in the MY 2020 fleet. These engines use the costing tabs in the Technologies file with the ‘L’ designation and are assumed to downsize to turbocharged 3-cylinder engines for costing purposes. We sought comment regarding the expected further application of this technology to larger cylinder count engines, such as 8-cylinder engines that may be turbo downsized to 4-cylinder engines. We also sought comment on how to define the characteristic of an engine that may be targeted for enhanced downsizing. We received no additional comments regarding enhanced downsizing.

²²⁶Richard Truett, “GM Bringing 3-Cylinder back to North America.” *Automotive News*, December 01, 2019. <https://www.autonews.com/cars-concepts/gm-bringing-3-cylinder-back-na>. (Accessed: February 17, 2022)

²²⁷Stoklosa, Alexander, “2021 Mini Cooper Hardtop.” *Car and Driver*, December 2, 2014. <https://www.caranddriver.com/reviews/a15109143/2014-mini-cooper-hardtop-manual-test-review/>. (Accessed: February 17, 2022)

²²⁸Leanse, Alex, “2020 For Escape Options: Hybrid vs. 3-Cylinder EcoBoost vs. 4-Cylinder EcoBoost.” *MotorTrend*, Sept 24, 2019. <https://www.motortrend.com/news/2020-ford-escape-engine-options-pros-and-cons-comparison/>. (Accessed: February 17, 2022)

Table III-8 – Examples of Engine Technology Class Assignment Logic

Observed Gasoline Engine Configuration	Observed Number of Cylinders	Horsepower	Naturally Aspirated or Turbo	Engine Technology Class Assigned
Inline	3	Any	NA	3C1B
Inline	3	Any	Turbo	4C1B_L
Inline	4	<=180	NA	4C1B_L
Inline	4	<=180	Turbo	4C1B
Boxer	4	<=180	NA	4C2B_L
Boxer	4	<=180	Turbo	4C2B
Inline	4	>180	NA	4C1B
Inline	4	>180	Turbo	6C2B
Boxer	4	>180	Turbo	6C2B
Inline	5	Any	Turbo	6C2B
W	16	Any	Turbo	16C4B

TSD Chapter 3.1.2 includes more details about baseline engine technology assignment logic, and details about the levels of engine technology penetration in the MY 2020 fleet.

(c) Engine Adoption Features

We defined engine adoption features through a combination of (1) refresh and redesign cycles, (2) technology path logic, (3) phase-in capacity limits, and (4) SKIP logic. Figure III-7 above shows the technology paths available for engines in the CAFE Model. Engine technology development and application typically results in an engine design moving from the basic engine tree to one of the advanced engine trees. Once an engine design moves to the advanced engine tree it is not allowed to move to alternate advanced engine trees. Specific path logic, phase-in caps, and SKIP logic applied to each engine technology are discussed by engine technology, in turn.

Refresh and redesign cycles dictate when we apply engine technology. Technologies applicable only during a platform redesign can be applied during a platform refresh if another vehicle platform that shares engine codes (uses the same engine) has already applied the technology during a redesign. For example, models of the GMC Acadia and the Cadillac XT4 use the same engine (assigned engine code 112011 in the Market Data file); if the XT4 adds a new engine technology during a redesign, then the Acadia may also add the same engine technology during the next refresh or redesign. This allows the model to maintain engine sharing relationships while also maintaining

refresh and redesign schedules.²²⁹ For engine technologies, DOHC, OHV, VVT, and CNG engine technologies are baseline only, while all other engine technologies can only be applied at a vehicle redesign.

Basic engine technologies in the CAFE Model are represented by four technologies: VVT, VVL, SGDI, and DEAC. DOT assumes that 100 percent of basic engine platforms use VVT as a baseline, based on wide proliferation of the technology in the U.S. fleet. The remaining three technologies, VVL, SGDI, and DEAC, can all be applied individually or in any combination of the three. An engine can jump from the basic engines path to any other engine path except the Alternative Fuel Engine Path.

Turbo downsizing allows manufacturers to maintain vehicle performance characteristics while reducing engine displacement and cylinder count. Any basic engine can adopt one of the turbo engine technologies (TURBO1, TURBO2, and CEGR1). Vehicles that have turbocharged engines in the baseline fleet will stay on the turbo engine path to prevent unrealistic engine technology change in the short timeframe considered in the rulemaking analysis. Turbo technology is a mutually exclusive technology in that it cannot be adopted for HCR, diesel, ADEAC, or CNG engines.

Non-HEV Atkinson enabled engines are a collection of engines in the HCR engine pathway (HCR0, HCR1, HCR1D, and HCR2). Atkinson enabled engines excel in lower power applications for

lower load conditions, such as driving around a city or steady state highway driving without large payloads. As a result, their adoption is more limited than some other technologies. We expanded the availability of HCR technology compared to the 2020 final rule because of new observed applications in the market.²³⁰ However, there are three categories of adoption features specific to the HCR engine pathway:²³¹

- We currently do not allow vehicles with 405 or more horsepower to adopt HCR engines due to their prescribed duty cycle being more demanding and likely not supported by the lower power density found in HCR-based engines.²³²
- Pickup trucks and vehicles that share engines with pickup trucks are currently excluded from receiving HCR engines; the duty cycle for these heavy vehicles, particularly the need for large torque reserves, results in an engine calibration that minimizes the advantage of Atkinson cycle use.²³³
- HCR engine application is also currently restricted for some manufacturers that are heavily

²³⁰ For example, the Hyundai Palisade and Kia Telluride have a 291 hp V6 HCR1 engine. The specification sheets for these vehicles are located in the docket for this action.

²³¹ See Section III.D.1.d)(1) (Engine Maps), for a discussion of why HCR2 and P2HCR2 were not used in the central analysis. "SKIP" logic was used to remove this engine technology from application, however as discussed below, we maintain HCR2 and P2HCR2 in the model architecture for sensitivity analysis and for future engine map model updates.

²³² Heywood, John B. Internal Combustion Engine Fundamentals. McGraw-Hill Education, 2018. Chapter 5.

²³³ This is based on CBI conversation with manufacturers that currently employ HCR-based technology but saw no benefit when the technology was applied to truck platforms in their fleet.

²²⁹ See Section III.C.2.a) for more discussion on platform refresh and redesign cycles.

performance-focused and have demonstrated a significant commitment to power dense technologies such as turbocharged downsizing.²³⁴

Advanced cylinder deactivation technology (ADEAC), or dynamic cylinder deactivation (e.g., Dynamic Skip Fire), can be applied to any engine with basic technology. This technology represents a naturally aspirated engine with ADEAC. Additional technology can be applied to these engines by moving to the Advanced Turbo Engine Path.

Miller cycle (VTG and VTGe) engines can be applied to any basic and turbocharged engine. VTGe technology is enabled by the use of a 48V system that presents an improvement from traditional turbocharged engines, and accordingly VTGe includes the application of a mild hybrid (BISG) system.

VCR engines can be applied to basic and turbocharged engines, but the technology is limited to specific OEMs.²³⁵ VCR technology requires a complete redesign of the engine, and in the analysis fleet, only two platforms had incorporated this technology. The agency does not believe any other manufacturers will invest to develop and market this technology in their fleet in the rulemaking time frame.

Advanced turbo engines are becoming more prevalent as the technologies mature. TURBOD combines TURBO1 and DEAC technologies and represents the first advanced turbo. TURBOAD combines TURBO1 and ADEAC technologies and is the second and last level of advanced turbos. Engines from either the Turbo Engine Path or the ADEAC Engine Path can adopt these technologies.

Any basic engine technologies (VVT, VVL, SGDI, and DEAC) can adopt ADSL and DSLI engine technologies. Any basic engine and diesel engine can adopt DSLIAD technology in this analysis; however, we applied a phase in cap and year for this technology at 34 percent and MY 2023, respectively. In our engineering judgement, this is a rather complex and costly technology to adopt and it would take significant investment for a manufacturer to develop. For more than a decade, diesel engine technologies have been used in less than one percent of the total light-duty fleet production and have been

²³⁴ There are three manufacturers that met the criteria (near 100 percent turbo downsized fleet, and future hybrid systems are based on turbo-downsized engines) described and were excluded: BMW, Daimler, and Jaguar Land Rover.

²³⁵ Nissan and Mitsubishi are strategic partners and members of the Renault-Nissan-Mitsubishi Alliance.

found mostly on medium and heavy-duty vehicles.

Finally, we allow the CAFE Model to apply EFR to any engine technology except for DSLI and DSLIAD. DSLI and DSLIAD inherently have incorporated engine friction technologies from ADSL. In addition, friction reduction technologies that apply to gasoline engines cannot necessarily be applied to diesel engines due to the higher temperature and pressure operation in diesel engines.

We sought comment on the appropriateness of engine adoption features, specifically for the HCR engines, and received feedback. Some commenters felt the constraints on application of HCR technology in the CAFE Model were too strict. Specifically, comments on this issue were received from ICCT, California Air Resources Board (CARB), a coalition of States and Cities, and a joint group of non-governmental organizations.^{236 237 238 239 240} ICCT described NHTSA's characterization of HCR with respect to the duty cycle requirements of high horsepower or high towing vehicles as "backwards and wrong," stating that:

engines in pickup trucks and high-performance vehicles are sized and powered to handle higher peak loads and, thus, operate at lower loads relative to their maximum capacity. According to supplemental tables for the 2020 EPA FE Trends report found online, pickups have 18 [percent] to 19 [percent] higher power to weight than both cars and truck SUVs, which means that pickup trucks and high-performance vehicles will spend more time in Atkinson Cycle operation than lower performance vehicles on both the test cycles and in the real world, not less. Any need for "additional torque reserve" is met by switching to Otto cycle. The one exception is towing, which does impose constant high loads on the engine. However, Strategic Vision data finds that "percent of [pickup] truck owners use their truck for towing one time a year or less". The large majority of pickup trucks spend the vast majority of driving at low loads relative to the engine's capability, where Atkinson Cycle engines are

²³⁶ ICCT, at p. 11.

²³⁷ CARB, Docket No. NHTSA-2021-0053-1521-A2, at pp. 6-8.

²³⁸ States of California, Colorado, Connecticut, Delaware, Hawaii, Illinois, Maine, Maryland, Michigan, Minnesota, Nevada, New Jersey, New Mexico, New York, North Carolina, Oregon, Rhode Island, Vermont, Washington, and Wisconsin; the Commonwealths of Massachusetts and Pennsylvania; the District of Columbia; the Cities and Counties of Denver and San Francisco; and the Cities of Los Angeles, New York, Oakland, and San Jose (NHTSA-2021-0053-1499) (California Attorney General et al.), Docket No. NHTSA-2021-0053-1499-A1, at p. 33.

²³⁹ Natural Resources Defense Council (NRDC), Docket No. NHTSA-2021-0053-1572-A1, at p. 7.

²⁴⁰ NRDC, A2, at pp. 46-47.

very effective. Thus, all restrictions on HCR engines should be removed.²⁴¹

We disagree with ICCT's and other comments regarding the appropriateness of the HCR technology constraints. Current HCR engines achieve the effects of a longer expansion stroke, necessary for Atkinson operation, using continuous variable valve timing. The timing of the intake valve closure is based on the current load demand on the engine. Under higher loads, the intake valves will close sooner in the cycle, increasing the dynamic compression ratio and decreasing the over-stroke of the expansion cycle, decreasing thermal efficiency, and increasing torque. This causes the engine to operate closer to an Otto combustion cycle than an Atkinson cycle. However, under these conditions, the engine is not able to completely achieve a traditional Otto cycle due to knock limitations and maintains a minimum of over-expansion behavior. While under lower loads the engine decreases the dynamic compression ratio, closing the intake valve later, and increasing the over-stroke of the expansion stroke reducing torque while increasing efficiency. Having the ability to continuously adjust the shape of the combustion cycle significantly improves the engine efficiency but does not give the engine the functional flexibility suggested by ICCT's interpretation of the technology description.

This is exemplified by Toyota's comment to the 2018 CAFE NPRM on the application of the HCR-based engine to the Tacoma platform, where Toyota stated that:

Tacoma has a greater coefficient of drag from a larger frontal area, greater tire rolling resistance from larger tires with a more aggressive tread, and higher driveline losses from 4WD. Similarly, the towing, payload, and off-road capability of pick-up trucks necessitate greater emphasis on engine torque and horsepower over fuel economy. This translates into engine specifications such as a larger displacement and a higher stroke-to-bore ratio. Tacoma's higher road load and more severe utility requirements push engine operation more frequently to the less efficient regions of the engine map and limit the level of Atkinson operation.²⁴²

In addition to operating issues, comments such as those provided by the Auto Innovators, also to the 2018 NPRM (83 FR 42986, Aug. 24, 2018), highlight packaging issues that make the application of HCR in high horsepower/high torque applications less practical. Specifically, the Alliance of Automobile

²⁴¹ ICCT, at p. 11.

²⁴² Toyota, Docket No. NHTSA-2018-0067-12376-A1, at pp. 8-9.

Manufacturer's²⁴³ comments to the 2018 NPRM stated that "[t]he Alliance agrees with the more restrained application of HCR1 in the Proposed Rule," and agreed with the agencies' rationale for the restrictions that included "[p]ackaging and emission constraints associated with intricate exhaust manifolds needed to mitigate high load/low revolutions per minute knock" and "Inherent performance limitations of Atkinson cycle engines."²⁴⁴ Ford echoed this concern, stating that "Ford supports the more restrained application of HCR1 in the Proposed Rule, an approach that recognizes the investment, packaging, performance and emissions factors that will limit penetration of this technology."²⁴⁵

Based on this discussion, and previously provided data, we have kept the HCR adoptions features used in the NPRM for the final rule, except for a correction to the HCR1D application. Keeping the constraints in place also aligns us with the most recent EPA rulemaking analysis.²⁴⁶ We do intend to continue research into the appropriateness of HCR technology applications in future analysis, as we look at timeframes beyond the current rulemaking.

Regarding the application of the HCR1D technology, a joint group of NGO comments, and others, pointed out an error in the CAFE Model input files used in the NPRM. The HCR1D technology was not set to 'true' for the central analysis.²⁴⁷ We agree the setting was left blank in error and is correctly assigned a 'true' value in the technology input file for the final rule analysis.

(d) Engine Effectiveness Modeling

Engine effectiveness values used for engine technologies in two ways. The values are either calculated based on the difference in full vehicle simulation results created using the Autonomie modeling tool, or determined by the effectiveness values using an alternate calculation method, including analogous improvement or fuel economy improvement factors.

(1) Engine Maps

Effectiveness values used as inputs for the CAFE Model are determined by comparing results of full vehicle simulations using the Autonomie simulation tool. For a full discussion about how Autonomie was used, see Section III.C.4 and TSD Chapter 2.4, in addition to the Autonomie model documentation. Engine map models are the primary inputs used to simulate the effects of different engine technologies in the Autonomie full vehicle simulations.

Engine maps provide a three-dimensional representation of engine performance characteristics at each engine speed and load point across the operating range of the engine. Engine maps have the appearance of topographical maps, typically with engine speed on the horizontal axis and engine torque, power, or brake mean effective pressure (BMEP)²⁴⁸ on the vertical axis. A third engine characteristic, such as brake-specific fuel consumption (BSFC),²⁴⁹ is displayed using contours overlaid across the speed and load map. The contours provide the values for the third characteristic in the regions of operation covered on the map. Other characteristics typically overlaid on an engine map include engine emissions, engine efficiency, and engine power. The engine maps developed to model the behavior of the engines used in this analysis are referred to as engine map models.

The engine map models used in this analysis are representative of technologies that are currently in production or are expected to be available in the rulemaking timeframe. The engine map models are developed to be representative of the performance achievable across industry for a given technology and are not intended to represent the performance of a single manufacturer's specific engine. The broadly representative performance level was targeted because the same combination of technologies produced by different manufacturers will have differences in performance, due to manufacturer-specific designs for engine hardware, control software, and emissions calibration.

Accordingly, we expect that the engine maps developed for this analysis will differ from engine maps for

manufacturers' specific engines. However, we intend and expect that the incremental changes in performance modeled for this analysis, due to changes in technologies or technology combinations, will be similar to the incremental changes in performance observed in manufacturers' engines for the same changes in technologies or technology combinations.

The analysis never applies absolute BSFC levels from the engine maps to any vehicle model or configuration for the rulemaking analysis. The absolute fuel economy values from the full vehicle Autonomie simulations are used only to determine incremental effectiveness for switching from one technology to another technology. The incremental effectiveness is applied to the absolute fuel economy of vehicles in the analysis fleet, which are based on CAFE compliance data. For subsequent technology changes, incremental effectiveness is applied to the absolute fuel economy level of the previous technology configuration. Therefore, for a technically sound analysis, it is most important that the differences in BSFC among the engine maps be accurate, and not the absolute values of the individual engine maps.

For this analysis, we use a small number of baseline engine configurations with well-defined BSFC maps, and then, in a very systematic and controlled process, add specific well-defined technologies to create a BSFC map for each unique technology combination. This can theoretically be done using engine or vehicle testing, but testing would need to be conducted on a single engine, and each configuration would require physical parts and associated engine calibrations to assess the impact of each technology configuration, which is impractical for the rulemaking analysis because of the extensive design, prototype part fabrication, development, and laboratory resources that are required to evaluate each unique configuration. Modeling is an approach used by industry to assess an array of technologies with more limited testing. Modeling offers the opportunity to isolate the effects of individual technologies by using a single or small number of baseline engine configurations and incrementally adding technologies to those baseline configurations. This provides a consistent reference point for the BSFC maps for each technology and for combinations of technologies that enables the differences in effectiveness among technologies to be carefully identified and quantified.

²⁴³ Now Alliance for Automotive Innovation, also referred to as Auto Innovators.

²⁴⁴ Auto Innovators, Docket No. NHTSA-2018-0067-12073-A1, at p. 139.

²⁴⁵ Ford, Docket No. NHTSA-2018-0067-11928-A1, at p. 8.

²⁴⁶ See U.S. EPA, "Revised 2023 and Later Model Year Light-Duty Vehicle GHG Emissions Standards: Regulatory Impact Analysis." December 2021. EPA-420-R-21-028. <https://nepis.epa.gov/Exe/ZyPDF.cgi?Dockey=P1013ORN.pdf>. (Accessed: March 9, 2022)

²⁴⁷ NRDC, at pp. 46-47.

²⁴⁸ Brake mean effective pressure is an engineering measure, independent of engine displacement, which indicates the actual work an engine performs.

²⁴⁹ Brake-specific fuel consumption is the rate of fuel consumption divided by the power being produced.

The Autonomie model documentation provides a detailed discussion on how the engine map models were used as inputs to the full vehicle simulations performed using the Autonomie tool. The Autonomie model documentation contains the engine map model topographic figures, and additional engine map model data can be found in the Autonomie input files.²⁵⁰

We received a comment from the High Octane Low Carbon Fuel Alliance regarding the potential use of high octane fuels. The High Octane Low Carbon Fuel Alliance stated, “Higher octane enables greater engine efficiency and improved vehicle performance through higher compression ratios and/or more aggressive turbocharging and downsizing—also facilitated by ethanol’s cylinder “charge cooling” effect due to its high heat of vaporization.²⁵¹ Raising the engine’s compression ratio from 10:1 to 12:1 could increase vehicle efficiency by 5 to 7 percent.”^{252 253}

²⁵⁰ See additional Autonomie supporting materials in docket number NHTSA–2021–0053 for this rule.

²⁵¹ J.E. Anderson et al., “High octane number ethanol-gasoline blends: Quantifying the potential benefits in the United States,” *Fuel* (2012): 97: pp. 585–594: <https://www.sciencedirect.com/science/article/pii/S0016236112002268>. (Accessed: February 17, 2022)

²⁵² David S. Hirshfeld et al., “Refining Economics of U.S. Gasoline: Octane Ratings and Ethanol Content,” *Environmental Science & Technology* (2014): 48(19): pp. 11064–11071: <https://pubs.acs.org/doi/pdf/10.1021/es5021668>. (Accessed: February 17, 2022)

²⁵³ Thomas G. Leone et al., “The Effect of Compression Ratio, Fuel Octane Rating, and

We agree with the data provided; however, we simulate the use of Tier 3 fuel in our engine technology models to represent the fuel available and most commonly used by consumers.²⁵⁴ If we assumed that high octane fuel was used in the engine map models, we would be assuming a greater fuel economy benefit than would actually be achieved in the real world, which would overestimate the benefits of more stringent standards. Moreover, to date, vehicle manufacturers do not appear to be pursuing this technology path. As we have stated previously, regulation of fuels is also outside of the scope of NHTSA’s authority. Accordingly, we made no updates to the fuel assumed used in the engine map models.

(a) IAV Engine Map Models

Most of the engine map models used in this analysis were developed by IAV GmbH (IAV) Engineering. IAV is one of the world’s leading automotive industry engineering service partners with an over 35-year history of performing research and development for powertrain components, electronics, and vehicle design.²⁵⁵ The primary outputs of IAV’s work for this analysis are engine maps that model the

Ethanol Content on Spark- Ignition Engine Efficiency,” *Environmental Science & Technology* (2015): 49(18): pp. 10778–10789: <https://pubs.acs.org/doi/abs/10.1021/acs.est.5b01420>. (Accessed: February 17, 2022)

²⁵⁴ See TSD Chapter 3.1 for a detailed discussion on engine map model assumptions.

²⁵⁵ IAV Automotive Engineering, <https://www.iav.com/en/>. (Accessed: February 17, 2022)

operating characteristics of engines equipped with specific technologies.

The generated engine maps are validated against IAV’s global database of benchmarked data, engine test data, single cylinder test data, prior modeling studies, technical studies, and information presented at conferences.²⁵⁶ The effectiveness values from the simulation results are also validated against detailed engine maps produced from Argonne engine benchmarking programs, as well as published information from industry and academia, ensuring reasonable representation of simulated engine technologies.²⁵⁷ The engine map models used in this analysis and their specifications are shown in Table III–9.

BILLING CODE 4910–59–P

²⁵⁶ Friedrich, I., Pucher, H., and Offer, T., “Automatic Model Calibration for Engine-Process Simulation with Heat-Release Prediction,” SAE Technical Paper 2006–01–0655, 2006, <https://doi.org/10.4271/2006-01-0655>. (Accessed: February 17, 2022) Rezaei, R., Eckert, P., Seebode, J., and Behnk, K., “Zero-Dimensional Modeling of Combustion and Heat Release Rate in DI Diesel Engines,” *SAE Int. J. Engines* 5(3):874–885, 2012, <https://doi.org/10.4271/2012-01-1065>. (Accessed: February 17, 2022) Multistage Supercharging for Downsizing with Reduced Compression Ratio (2015). MTZ Rene Berndt, Rene Pohlke, Christopher Severin and Matthias Diezemann IAV GmbH. Symbiosis of Energy Recovery and Downsizing (2014). September 2014 MTZ Publication Heiko Neukirchner, Torsten Semper, Daniel Luederitz and Oliver Dingel IAV GmbH.

²⁵⁷ Bottcher, L., Grigoriadis, P. “ANL—BSFC map prediction Engines 22–26.” IAV (April 30, 2019). https://lindseyresearch.com/wp-content/uploads/2021/09/NHTSA-2021-0053-0002-20190430_ANL_Eng-22-26-20190430_ANL_Eng22-26Updated_Docket.pdf. (Accessed: February 17, 2022)

Table III-9 – Engine Map Models used in This Analysis

Engines	Technologies	Notes
Eng01	DOHC+VVT	Parent NA engine, Gasoline, 2.0L, 4 cyl, NA, PFI, DOHC, dual cam VVT, CR10.2
Eng02	DOHC+VVT+VVL	VVL added to Eng01
Eng03	DOHC+VVT+VVL+SGDI	SGDI added to Eng02, CR11
Eng04	DOHC+VVT+VVL+SGDI +DEAC	Cylinder deactivation added to Eng03
Eng5a	SOHC+VVT+PFI	Eng01 converted to SOHC (gasoline, 2.0L, 4cyl, NA, PFI, single cam VVT) For Reference Only
Eng5b	SOHC+VVT (level 1 Red. Friction)	Eng5a with valvetrain friction reduction (small friction reduction)
Eng6a	SOHC+VVT+VVL (level 1 Red. Friction)	Eng02 with valvetrain friction reduction (small friction reduction)
Eng7a	SOHC+VVT+VVL+SGDI (level 1 Red. Friction)	Eng03 with valvetrain friction reduction (small friction reduction), addition of VVL and SGDI
Eng8a	SOHC+VVT+VVL+SGDI +DEAC (level 1 Red. Friction)	Eng04 with valvetrain friction reduction (small friction reduction), addition of DEAC
Eng12	DOHC Turbo 1.6l 18bar	Parent Turbocharged Engine, Gasoline, 1.6L, 4 cyl, turbocharged, SGDI, DOHC, dual cam VVT, VVL Engine BMEP: 18 bar
Eng12 DEAC	DOHC Turbo 1.6l 18bar	Eng12 with DEAC applied, Engine BMEP 18bar
Eng13	DOHC Turbo 1.2l 24bar	Eng12 downsized to 1.2L, Engine BMEP 24 bar
Eng14	DOHC Turbo 1.2l 24bar + Cooled EGR	Cooled external EGR added to Eng13 Engine BMEP 24 bar
Eng17	Diesel	Diesel, 2.2L (measured on test bed)
Eng18	DOHC+VVT+SGDI	Gasoline, 2.0L, 4 cyl, NA, SGDI, DOHC, VVT
Eng19	DOHC+VVT+DEAC	Cylinder deactivation added to Eng01
Eng20	DOHC+VVT+VVL+DEAC	Cylinder deactivation added to Eng02
Eng21	DOHC+VVT+SGDI+DEAC	Cylinder deactivation added to Eng18
Eng22b	DOHC+VVT	Atkinson-enabled 2.5L DOHC, VVT, PFI, CR14
Eng24	Current SkyActiv 2.0l 93AKI	Non-HEV Atkinson mode, Gasoline, 2.0L, 4 cyl, DOHC, NA, SGDI, VVT, CR 13.1, 93 AKI
Eng25	Future SkyActiv 2.0l CEGR 93AKI+DEAC	Non-HEV Atkinson mode, Gasoline, 2.0L, 4 cyl, DOHC, NA, SGDI, VVT, cEGR, DEAC CR 14.1, 93 AKI For Reference Only
Eng26	Atkinson Cycle Engine	HEV and PHEV Atkinson Cycle Engine 1.8L
Eng23b	DOHC+VTG+VVT+VVL+SGDI I +cEGR	Miller Cycle, 2.0L DOHC, VTG, SGDI, cEGR, VVT, VVL, CR12
Eng23c	DOHC+VTG+VVT+SGDI +cEGR+Eboost	Eng23b with an 48V Electronic supercharger and battery pack
Eng26a	DOHC+VCR+VVT+SGDI +Turbo+cEGR	VVT, SGDI, Turbo, cEGR, VCR CR 9-12

included in the agency modeling are severely outdated. For example, all base naturally aspirated engine maps are based on an unidentified 2013 or older vehicle, all turbo (non-Miller cycle) maps are based on a vehicle whose specifications match that of the 2011 MINI R56 N18/BMW N13 engine, the hybrid Atkinson cycle map (for PS and PHEV) is based on the 2010 Toyota Prius, and the HCR1 map is based on the 2014 Mazda SkyActiv 2.0L engine. Essentially, NHTSA is assuming there will be no efficiency improvements in any of these technologies through at least 2026, or for 12 to 16 years from the model year of the vehicle used to generate the maps.”²⁵⁸

We disagree with statements that the IAV engine maps are outdated. Many of the engine maps were developed specifically to support analysis for the current rulemaking time frame. The engine map models encompass engine technologies that are present in the analysis fleet and technologies that could be applied in the rulemaking timeframe. In many cases those engine technologies are mainstream today and will continue to be during the rulemaking timeframe. For example, the engines on some MY 2020 vehicles in the analysis fleet have technologies that were initially introduced ten or more years ago. Having engine maps representative of those technologies is important for the analysis. The most basic engine technology levels also provide a useful baseline for the incremental improvements for other engine technologies. The timeframe for the testing or modeling is unimportant because time by itself doesn't impact engine map data. A given engine or model will produce the same BSFC map regardless of when testing or modeling is conducted. Simplistic discounting of engine maps based on temporal considerations alone could result in discarding useful technical information.

If we did use a mix of engine maps from engine modeling and from benchmarking data, no common reference for measuring impacts of adding specific technological improvements would exist. Additionally, manufacturers often implement multiple fuel-saving technologies simultaneously when redesigning a vehicle and it is not possible to isolate the effect of individual technologies by using laboratory measurements of a single production engine or vehicle with a combination of technologies.²⁵⁹ Because

so many vehicle and engine changes are involved, it is not possible to attribute effectiveness improvements accurately for benchmarked engines to specific technology changes. Further, while two or more different manufacturers may produce engines with the same high level technologies (such as a DOHC engine with VVT and SGDI), each manufacturer's engine will have unique component designs that cause its version of the engine to have a unique engine map. For example, engines with the same high level technologies have unique intake manifold and exhaust manifold runners, cylinder head ports and combustion chamber geometry that impact charge motion, combustion and efficiency, as well as unique valve control, compression ratios, engine friction, cooling systems, and fuel injector spray characteristics, among other factors. All of these differences lead to potential overcounting or undercounting technology effectiveness per cost. As described above, our approach allows the analysis to isolate the effects of individual technologies by incrementally adding individual technologies to baseline engine configurations. We selected this approach for the NPRM and final rule and discuss it in detail in the TSD.²⁶⁰

As a result, it should not be expected that any of our engine maps would necessarily align with a specific manufacturer's engine, unless of course the engine map was developed from that specific engine. We do not agree that comparing an engine map used for the rulemaking analysis to a single specific benchmarked engine has technical relevance, beyond serving as a general corroboration for the engine map. When a vehicle is benchmarked, the resulting data are dictated by the unique combination of technologies and design

²⁵⁸ 12431 (“Atkinson-cycle operation is just one of several measures responsible for the 2.5L Dynamic Force engine achieving a world-best 40 percent thermal efficiency. The Late Intake Valve Closing (LIVC) of the Atkinson cycle reduces low-load pumping losses and supports the 13:1 CR by suppressing engine knock. However, the engine's increased stroke-to-bore ratio (S/B ratio) and improved cooling, engine warmup, friction reduction, and exhaust system play an equally important role. For example, the 1.18 S/B ratio preserves stable combustion under high EGR flow rates which improves thermal efficiency as much as the longer effective expansion ratio from the Atkinson cycle. The increased S/B ratio also complements intake port, valve timing (VVT-iE) and piston enhancements resulting in greater tumble intensity of the charge-air intake, higher speed combustion, and increased thermal efficiency. Greater detail on factors contributing to the thermal efficiency of the 2018 Camry 2.5L engine can be found in Toyota SAE paper 2017-01-1021 contained in Appendix 1 of this submission.”).

²⁶⁰ See TSD Chapter 3.1.

constraints for the whole vehicle system.

ICCT further stated: “As just two examples of how absurd it is to assume no improvements in any of these engine technologies for at least 12 years, the turbocharged engine introduced by Honda in 2016 was significantly more efficient than the engine used to generate all the turbocharged maps in the proposed rule and the 2018 Camry hybrid improved fuel economy by 15 (XLE/SE) to 25 percent (LE) compared to the 2017 Camry hybrid. And these (unincorporated) improvements were already in the market by 2016 and 2018—still 8 to 10 years before 2026. For additional information see UCS Reconsideration Petition pages 68–72.”²⁶¹ ICCT also stated “EPA added a 2nd generation turbocharged downsized engine package based on EPA benchmark testing of the Honda L15B7 1.5L turbocharged, direct-injection engine to its 2018 MTE, which was not used in NHTSA's proposed rule.”²⁶²

Our effectiveness data, including engine map models, is not used in the rulemaking analysis in the manner described in ICCT's comments. Our analysis does not apply absolute BSFC levels from the engine maps to any vehicle model or configuration for the rulemaking analysis. The absolute fuel economy values from the full vehicle Autonomie simulations are used only to determine incremental effectiveness for switching from one technology to another technology. The incremental effectiveness is applied to the absolute fuel economy of vehicles in the analysis fleet, which are based on CAFE compliance data. For subsequent technology changes, incremental effectiveness is applied to the absolute fuel economy level of the previous technology configuration. Therefore, for a technically sound analysis, it is most important that the differences in BSFC among the engine maps be accurate, and not the absolute values of the individual engine maps.

This comment also mirrors a similar ICCT comment to the 2018 NPRM.²⁶³ In the 2020 final rule, we compared two IAV engine maps to the EPA's benchmarked Toyota 2017 2.5L naturally aspirated engine and Honda's 2016 1.5L turbocharged downsized engine for predicted effectiveness improvements. The IAV engines were modeled and simulated in a midsize non-performance vehicle with an automatic transmission and the same

²⁶¹ ICCT, at p. 4.

²⁶² *Id.*

²⁶³ ICCT, Attachment 3, Docket No. NHTSA-2018-0067-11741, at p. I-49.

²⁵⁸ ICCT, at p. 3.

²⁵⁹ See *e.g.*, Toyota Supplemental Comments to the 2018 NPRM, Docket No. NHTSA-2018-0067-

road load technologies, MR0, ROLL0 and AERO0, to isolate for the benefits associated with the specific engine maps.²⁶⁴ Eng 12, a 1.6L, 4-cylinder, turbocharged, SGDI, DOHC, dual cam VVT, VVL engine was selected as the closest engine configuration to the Honda 1.5L.²⁶⁵ Eng 22b, a 2.5L, 4 cylinder, VVT Atkinson cycle engine, was selected as the closest engine configuration to the Toyota 2.5L.²⁶⁶ Both the Toyota 2.5L naturally aspirated engine and Honda's 1.5L engine have incorporated a number of fuel saving technologies, including improved accessories and engine friction reduction. To assure an "apples-to-apples" comparison, both IACC and

EFR technologies were applied to the IAV engine maps. IACC technology provides an additional 3.6 percent incremental improvement and EFR provides an additional 1.4 percent incremental improvement beyond the IAV engine maps for midsize non-performance vehicles.

The comparison shows that the relative effectiveness of the IAV engine maps are in line with the Honda 1.5L and the Toyota 2.5L benchmarked engines. Figure III-8 below shows the effectiveness improvements for the EPA benchmarked engines and the corresponding IAV engine maps incremental to a baseline vehicle. Accordingly, we believe that the

methodology used in this analysis, and the engine maps and incremental effectiveness values used, are in line with benchmarking data and are reasonable for the rulemaking analysis. We believe the approach used in this rulemaking analysis appropriately allows us to account for a wide array of engine technologies that could be adopted during the rulemaking timeframe. Declining to use manufacturer-specific engines allows us to ensure that all effectiveness and cost improvements due to the incremental addition of fuel economy improving technologies are appropriately accounted for.

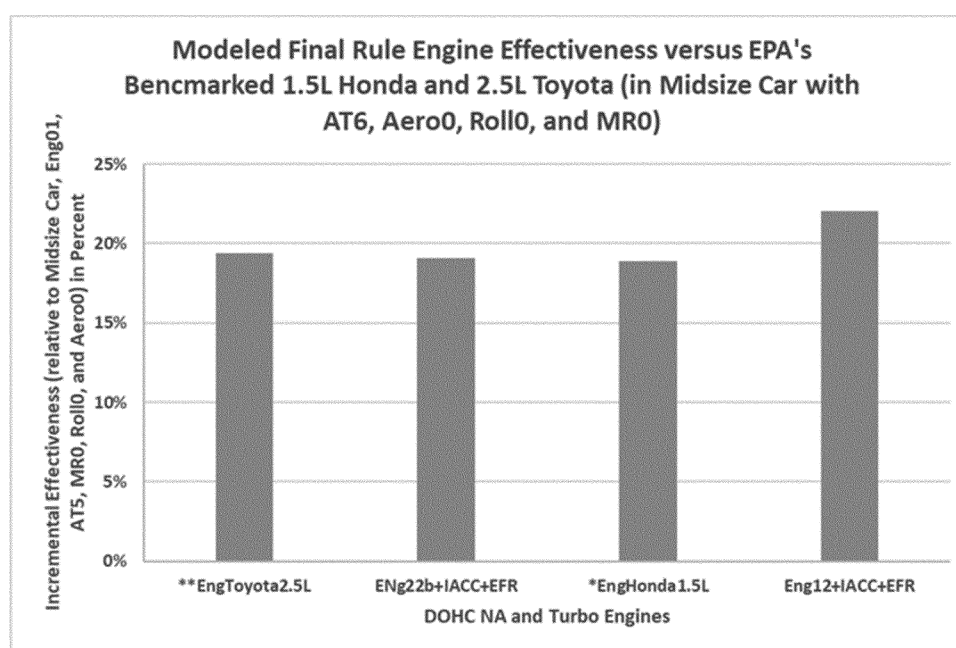

Figure III-8 – Comparison of Engine Effectiveness used for the Final Rule Analysis versus EPA benchmarked Honda 1.5L Turbo Engine and Toyota 2.5L NA Engine

(b) Other Engine Map Models

Two of the engine map models we show in Table III-9, Eng24 and Eng25, were not developed as part of the IAV modeling effort and we only used Eng24 in this analysis. The Eng24 and Eng25 engine maps are equivalent to the ATK and ATK2 engine map models developed for the 2016 Draft TAR, EPA Proposed Determination, and Final Determination.²⁶⁷ The ATK1 engine

model is based directly on the 2.0L 2014 Mazda SkyActiv-G (ATK) engine. The ATK2 represents an Atkinson engine concept based on the Mazda engine, adding cEGR, cylinder deactivation, and an increased compression ratio (14:1). In this analysis, Eng24 and Eng25 correspond to the HCR1 and HCR2 technologies.

We used the same HCR2 engine map model application in this analysis as we used in the 2020 final rule.²⁶⁸ The

agency believes the use of HCR0, HCR1, and the new addition of HCR1D reasonably represents the application of Atkinson Cycle engine technologies within the current light-duty fleet and the anticipated applications of Atkinson Cycle technology in the MY 2024–2026 timeframe. We sought comment on whether and how to change our engine maps for HCR2 in the analysis for the final rule.

²⁶⁴ See TSD Chapter 3.4, TSD Chapter 3.5, and TSD Chapter 3.6 for more information on road load modeling.

²⁶⁵ See TSD Chapter 3.1 for more discussion on modeled engine technologies.

²⁶⁶ See TSD Chapter 3.1 for more discussion on modeled engine technologies.

²⁶⁷ Ellies, B., Schenk, C., and Dekraker, P., "Benchmarking and Hardware-in-the-Loop Operation of a 2014 MAZDA SkyActiv 2.0L 13:1

Compression Ratio Engine," SAE Technical Paper 2016-01-1007, 2016, doi:10.4271/2016-01-1007.

²⁶⁸ 85 FR 24425-27 (April 30, 2020).

ICCT, among others supported the use of the HCR2 engine map model stating that:^{269 270 271 272}

Not only does EPA's proposed rule allow HCR2 technology to be used in their modeling, but comments previously submitted and previous EPA documentation provide extensive justification for HCR2 technology benefits beyond just HCR1D. Also, both cooled EGR and cylinder deactivation have been in production since 2018. Thus, it is not credible to assume no further advances in HCR technology prior to 2027. Further, the manufacturer claim of "diminishing returns to additional conventional engine technology improvements" is also not credible, given the discussion in the Appendix Section 1 of extensive engine technologies under development that can reduce GHG emissions by over 30 [percent]. ICCT certainly supports developing an updated family of HCR engine map models that incorporate many of the technologies discussed in Section 1 for future rulemakings. But in the interim, HCR2 should be allowed in the Final Rule using EPA's engine map for HCR2 developed in the Technical Support Documents for EPA's Proposed and 2017 Final Determination.²⁷³

Other commenters were opposed to the use of the HCR2 engine map model in the analysis. Toyota provided comment on both the NHTSA and EPA analysis, stating that:

HCR2 Atkinson engine technology has returned to EPA's compliance modeling. EPA now defines HCR2 as "the addition of dynamic cylinder deactivation and cooled EGR within non-HEV Atkinson Cycle engine applications". However, the cost, technology effectiveness, and underlying engine map used for modeling HCR2 technology appears identical to that used for the SAFE 2 Final Rule which is represented by the simulated and experimental effectiveness of the 2014 2.0L SKYACTIV engine with the addition of cooled Exhaust Gas Recirculation (cEGR), 14:1 compression ratio (CR), and cylinder deactivation. There is still no U.S. production vehicle that incorporates this definition of HCR2 technology because the 14:1 CR requires higher octane than currently available in U.S. regular grade gasoline. Further, there are more cost-effective pathways than combining cylinder deactivation with Atkinson cycle engines which have inherently low pumping loss characteristics.

EPA compliance modeling applies HCR2 engine technology to over 40 percent of Toyota's fleet by 2026 model year. For example, Camry receives HCR2 along with engine friction reduction (EFR) in 2024 model year. The resulting 51.7 mpg fuel economy is about a 9 [percent] improvement over Toyota's current generation Camry powered by a 2.5L Atkinson engine which has a world-best 40 [percent] thermal

efficiency. The modeled [CO₂] and fuel economy are closer to hybrid Camry performance and are unreasonably large for the technologies involved. First, cylinder deactivation is the only practical distinction between HCR2 and Toyota's 2.5L Dynamic Force Atkinson engine. NHTSA's evaluation has determined applying only cylinder deactivation to Atkinson cycle engines (HCR1) nets an incremental improvement of roughly 2 percent. Second, the 2.5L Dynamic Force engine already encompasses EFR as explained in past comments under CBI. Finally, IACC and EFR benefits appear to be double counted on top of ERF already being included in the Camry 2.5L Atkinson engine. This is because IACC and EFR are both fully included in the simulated HCR2 engine map, yet both technologies are added again in the CAFE Model runs.

EPA modeling sequentially adds enhanced technology to a 2017 baseline fleet until compliance with the proposed standards is achieved. The 2017 model year fleet is outdated because it fails to capture more recent state-of-the-art technologies in the U.S. fleet and requires the [CO₂] reduction effectiveness of those technologies to be assumed or simulated. An example is Toyota's 2.5L Atkinson engine technology which has been in the market since 2018 model year. The Camry example above could largely be avoided using a more recent baseline. A 2020 model year baseline fleet is more appropriate and provides a more accurate performance assessment, and with fewer product redesign cycles available, there is less chance for technology effectiveness errors to propagate through the fleet. The 2017 baseline has resulted in more Atkinson technology being assumed in the 2018 through 2021 model year fleets than really exists in the market.

Toyota further stated,

For compliance modeling of gasoline powertrains, EPA is extensively relying on the HCR2 classification of Atkinson engine technology for which the assumed efficacy remains unproven and highly unlikely as previously explained. NHTSA effectively deploys only to the HCR1 level of Atkinson engines which better reflects the state of technology in the fleet today and identifies HCR1D as a more advanced future pathway that while not cost-effective has a considerably more reasonable assumed technology effectiveness than HCR2.²⁷⁴

The Auto Innovators also provided information and comment on the HCR2 engine map model:

In the GHG NPRM [86 FR 43726, August 10, 2021], EPA resurrected highly optimistic effectiveness estimates for future Atkinson cycle engines based on a speculative engine map, and used the results as "HCR2" technology. The use of this technology package can diminish the integrity of the analysis and distort discussions of technological feasibility and economic practicability of future standards. We recommend against the inclusion of this technology package in the CAFE Model at this time.

²⁷⁴ Toyota, at pp. 3–4.

While some organizations have asserted that EPA's 2016 characterization of HCR2 is a reasonable characterization of engines in the market today, like Toyota's 2.5L on the Camry and RAV4, or Mazda's 2.5L on the CX-5, history has shown that the HCR2 assumptions used in EPA's analysis significantly and unreasonably overestimate the real-world fuel saving capability of state-of-the-art Atkinson engine technology in these applications. The EPA HCR2 engine map assumes engine accessory drive improvements ("IACC") and engine friction reduction ("EFR") have already been used to the maximum extent possible, so reapplying these technologies again in the modeling (as the EPA analysis does) incorrectly double counts the potential effectiveness of these technologies. EPA incorrectly states that HCR2 technology, as modeled, exists in the fleet and is widely available for adoption.²⁷⁵

After review of the comments provided, we continue to believe HCR engine technology shows promise for future ICE fuel economy improvements and we continue with testing and validation for the IAV-generated HCR engine map model family so that those engine map models can be used in future analyses. However, we also believe that this specific engine map model presents several problems when considered in the context of this analysis. First, we believe that the technology combination modeled by the HCR2 engine map is unlikely to be utilized in the rulemaking timeframe based on comments received from the industry leaders in HCR technology application. Second, as illustrated by the Auto Innovators, this specific engine map model provides an excessive jump in effectiveness when compared to the other IAV-based engine map models used in this analysis. As a result, we have decided to continue to exclude the HCR2 engine map model from our central analysis. We will continue to expand the HCR engine map model family of technologies in future analyses. This is consistent with EPA's current assessment of their own model and choice to exclude the HCR2 engine in their final rule analysis.²⁷⁶

(2) Analogous Engine Effectiveness Improvements and Fuel Economy Improvement Values

For some technologies, the effectiveness for applying an incremental engine technology is determined by using the effectiveness values for applying the same engine technology to a reasonably similar base

²⁷⁵ Auto Innovators, at pp. 49–51.

²⁷⁶ See U.S. EPA, "Revised 2023 and Later Model Year Light-Duty Vehicle GHG Emissions Standards: Regulatory Impact Analysis." December 2021. EPA-420-R-21-028. <https://nepis.epa.gov/Exe/ZyPDF.cgi?Dockey=P1013ORN.pdf>. (Accessed: March 9, 2022)

²⁶⁹ NRDC, at p. 47.

²⁷⁰ UGS, at p. 6.

²⁷¹ CARB, at p. 4.

²⁷² California Attorney General et al., A2, at p. 33.

²⁷³ ICCT, at p. 11.

engine. An example of this can be seen in the determination of the application of SGDI to the baseline SOHC engine. Currently there is no engine map model for the SOHC+VVT+SGDI engine configuration. To create the effectiveness data required as an input to the CAFE Model, first, a pairwise comparison between technology configurations that included the DOHC+VVT engine (Eng1) and the DOHC+VVT+SGDI (Eng18) engine was

conducted. Then, the results of that comparison were used to generate a data set of emulated performance values for adding the SGDI technology to the SOHC+VVT engine (Eng5b) systems.

The pairwise comparison is performed by finding the difference in fuel consumption performance between every technology configuration using the analogous base technology (*e.g.*, Eng1) and every technology configuration that only changes to the

analogous technology (*e.g.*, Eng18). The individual changes in performance between all the technology configurations are then added to the same technology configurations that use the new base technology (*e.g.*, Eng5b) to create a new set of performance values for the new technology (*e.g.*, SOHC+VVT+SGDI). Table III–10 shows the engine technologies where analogous effectiveness values were used.

Table III-10 – Engine Technology Performance Values Determined by Analogous Effectiveness Values

Analogous Baseline	Analogous Technology	New Base Technology	New Technology
Eng1 DOHC+VVT	Eng18 DOHC+VVT+SGDI	Eng5b SOHC+VVT	SOHC+VVT+SGDI
Eng1 DOHC+VVT	Eng19 SOHC+VVT+DEAC	Eng5b SOHC+VVT	SOHC+VVT+DEAC
Eng1 DOHC+VVT	Eng20 DOHC+VVT+VVL+ DEAC	Eng5b SOHC+VVT	SOHC+VVT+VVL + DEAC
Eng1 DOHC+VVT	Eng21 DOHC+VVT+SGDI+DE AC	Eng5b SOHC+VVT	SOHC+VVT+SGDI + DEAC
Eng12 (TURBO1)	Eng12DEAC (TURBOD)	Eng24 (HCR1)	HCR1D

The agency received a comment about the use of analogous estimation from ICCT. ICCT stated,

The modeled benefit of adding cylinder deactivation to turbocharged and HCR1 vehicles is only about 25 [percent] of the benefit from adding DEAC or ADEAC to a basic engine. While adding DEAC to a turbocharged or HCR1 engine has smaller pumping loss reductions than for base naturally aspirated engines, DEAC still has significant pumping loss reductions and has the additional benefit of enabling the engine to operate in a more thermal efficient region of the engine fuel map. The agencies also failed to provide even the most basic information supporting their effectiveness estimates for TURBOD. Further compounding the problem, NHTSA based the effectiveness of adding DEAC to HCR engines on the TURBOD estimate, without any further justification.²⁷⁷

We disagree with ICCT's characterization of the TURBOD engine map model as "not having information supporting its creation." A discussion of the creation of the TURBOD engine map model, along with all the engine map models, is provided in Chapter 3.1.3.1 of the TSD. Furthermore, as discussed

in Chapter 3.1.3.2.1 of the TSD, the HCR1D effectiveness values are based on application of the DEAC technology to a similar technology model (TURBO1) where there is a reduced pumping loss benefit. Additionally, commenters did not indicate what effectiveness values they would consider reasonable or plausible, and NHTSA has no new data to support the ICCT position. As a result, we will continue to use the effectiveness values from the NPRM for the final rule analysis.

We also developed a static fuel efficiency improvement factor to simulate applying an engine technology for some technologies where there is either, no appropriate analogous technology, or there are not enough data to create a full engine map model. The improvement factors are developed based on a literature review or confidential business information (CBI) provided by stakeholders. Table III–11 provides a summary of the technology effectiveness values simulated using improvement factors, and the value and rules for how the improvement factors are applied. Advanced cylinder deactivation (ADEAC, TURBOAD,

DSLAD), advanced diesel engines (DSLIA) and engine friction reduction (EFR) are the three technologies modeled using improvement factors.

The application of the advanced cylinder deactivation is responsible for three of the five technologies using an improvement factor in this analysis. The initial review of the advanced cylinder deactivation technology is based on a technical publication that used a MY 2010 SOHC VVT basic engine.²⁷⁸ Additional information about the technology effectiveness came from a benchmarking analysis of pre-production 8-cylinder OHV prototype systems.²⁷⁹ However, at the time of the

²⁷⁸ Wilcutts, M., Switkes, J., Shost, M., and Tripathi, A., "Design and Benefits of Dynamic Skip Fire Strategies for Cylinder Deactivated Engines," SAE Int. J. Engines 6(1):278–288, 2013, available at <https://doi.org/10.4271/2013-01-0359> (Accessed: February 17, 2022); Eisazadeh-Far, K. and Younkins, M., "Fuel Economy Gains through Dynamic-Skip-Fire in Spark Ignition Engines," SAE Technical Paper 2016-01-0672, 2016, available at <https://doi.org/10.4271/2016-01-0672>. (Accessed: February 17, 2022).

²⁷⁹ EPA, 2018. "Benchmarking and Characterization of a Full Continuous Cylinder Deactivation System." Presented at the SAE World Congress, April 10–12, 2018. Retrieved from <https://>

Continued

²⁷⁷ ICCT, at pp. 4–5.

analysis no studies of production versions of the technology are available, and the only available technology effectiveness came from existing studies, not operational information. Thus, only estimates of effect can be developed and not a full model of operation. No engine map model can be developed, and no other technology pairs are analogous.

To model the effects of advanced cylinder deactivation, an improvement factor is determined based on the information referenced above and applied across the engine technologies. The effectiveness values for naturally aspirated engines are predicted by using full vehicle simulations of a basic engine with DEAC, SGDI, VVL, and VVT, and adding 3 percent or 6 percent improvement based on engine cylinder count: 3 percent for engines with 4 cylinders or less and 6 percent for all other engines. Effectiveness values for turbocharged engines are predicted using full vehicle simulations of the

TURBOD engine and adding 1.5 percent or 3 percent improvement based on engine cylinder count: 1.5 percent for engines with 4 cylinders or less and 3 percent for all other engines. For diesel engines, effectiveness values are predicted by using the DSLI effectiveness values and adding 4.5 percent or 7.5 percent improvement based on vehicle technology class: 4.5 percent improvement is applied to small and medium non-performance cars, small performance cars, and small non-performance SUVs. 7.5 percent improvement is applied to all other vehicle technology classes.

The analysis models advanced engine technology application to the baseline diesel engine by applying an improvement factor to the ADSL engine technology combinations. A 12.8 percent improvement factor is applied to the ADSL technology combinations to create the DSLI technology combinations. The improvement in performance is based on the application

of a combination of low pressure and high pressure EGR, reduced parasitic loss, advanced friction reduction, incorporation of highly integrated exhaust catalyst with low temp light off temperatures, and closed loop combustion control.^{280 281 282 283}

As discussed above, the application of the EFR technology does not simulate the application of a specific technology, but the application of an array of potential improvements to an engine. All reciprocating and rotating components in the engine are potential candidates for friction reduction, and small improvements in several components can add up to a measurable fuel economy improvement.^{284 285 286 287} Because of the incremental nature of this analysis, a range of 1–2 percent improvement was identified initially, and narrowed further to a specific 1.39 percent improvement. The final value is likely representative of a typical value industry may be able to achieve in future years.

Table III-11 – Engine Technologies Modeled Using Efficiency Improvement Factors

Baseline Technology	Fuel Efficiency Improvement Factor	New Technology
DEAC	3% for ≤ 4 Cylinders 6% for > 4 Cylinders	ADEAC
TURBOD	1.5% for ≤ 4 Cylinders 3% for > 4Cylinders	TURBOAD
ADSL	12.8%	DSLI
DSLI	4.5% for small and medium non-performance cars and SUVs, and small performance cars; 7.5% for all other technology classes	DSLADIAD
All Engine Technologies	1.39%	EFR

(3) Engine Effectiveness Values

The effectiveness values for the engine technologies, for all ten vehicle technology classes, are shown in Figure III–8. Each of the effectiveness values shown are representative of the improvements seen for upgrading only

the listed engine technology for a given combination of other technologies. In other words, the range of effectiveness values seen for each specific technology (e.g., TURBO1) represents the addition of the TURBO1 technology to every technology combination that could

select the addition of TURBO1. See Table III–12 for several specific examples. It must be emphasized, the change in fuel consumption values between entire technology keys are

www.regulations.gov/document?D=EPA-HQ-OAR-2018-0283-0029. (Accessed: February 17, 2022).

²⁸⁰ 2015 NAS Report, at p. 104.

²⁸¹ Hatano, J., Fukushima, H., Sasaki, Y., Nishimori, K., Tabuchi, T., Ishihara, Y. “The New 1.6L 2-Stage Turbo Diesel Engine for HONDA CR–V.” 24th Aachen Colloquium—Automobile and Engine Technology 2015.

²⁸² Steinparzer, F., Nefischer, P., Hiemesch, D., Kaufmann, M., Steinmayr, T. “The New Six-Cylinder Diesel Engines from the BMW In-Line Engine Module.” 24th Aachen Colloquium—Automobile and Engine Technology 2015.

²⁸³ Eder, T., Weller, R., Spengel, C., Böhm, J., Herwig, H., Sass, H. Tiessen, J., Knauel, P. “Launch of the New Engine Family at Mercedes-Benz.” 24th Aachen Colloquium—Automobile and Engine Technology 2015.

²⁸⁴ “Polyalkylene Glycol (PAG) Based Lubricant for Light- & Medium-Duty Axles.” 2017 DOE Annual Merit Review. Ford Motor Company, Gangopadhyay, A., Ved, C., Jost, N. https://energy.gov/sites/prod/files/2017/06/f34/ft023_gangopadhyay_2017_o.pdf.

²⁸⁵ “Power-Cylinder Friction Reduction through Coatings, Surface Finish, and Design.” 2017 DOE Annual Merit Review. Ford Motor Company.

Gangopadhyay, A. Erdemir, A. https://energy.gov/sites/prod/files/2017/06/f34/ft050_gangopadhyay_2017_o.pdf. (Accessed: February 17, 2022).

²⁸⁶ “Nissan licenses energy-efficient engine technology to HELLER.” <https://newsroom.nissan-global.com/releases/170914-01-e?lang=en-US&rss&la=1&downloadUrl=%2FReleases%2F170914-01-e%2Fdownload> (accessed: February 17, 2022).

²⁸⁷ “Infiniti’s Brilliantly Downsized V–6 Turbo Shines,” <https://wardsauto.com/engines/infiniti-s-brilliantly-downsized-v-6-turbo-shines> (accessed: February 17, 2022).

used,²⁸⁸ and not the individual technology effectiveness values. Using

the change between whole technology keys captures the complementary or

non-complementary interactions among technologies.

Table III-12 – Example of Effectiveness Calculations Shown in Figure III-9*

Tech	Vehicle Tech Class	Initial Technology Key	Fuel Consumption		Effectiveness (%)
			Initial (gal/mile)	New (gal/mile)	
TURBO 1	Medium Car	DOHC;VVT;;;;;AT8L2;SS12V; ROLL10;AERO5;MR2	0.0282	0.0248	12.15
TURBO 1	Medium Car	DOHC;VVT;;;;;AT8L2;CONV; ROLL10;AERO5;MR2	0.0292	0.0254	13.13
TURBO 1	Medium Car	DOHC;VVT;;;;;AT8L2;BISG; ROLL10;AERO5;MR2	0.0275	0.0237	13.80
TURBO 1	Medium Car	DOHC;VVT;;;;;AT6;SS12V; ROLL10;AERO5;MR2	0.0312	0.0269	13.80

*The ‘Tech’ is added to the ‘Initial Technology Key’ replacing the existing engine technology, resulting in the new fuel consumption value. The percent effectiveness is found by determining the percent improved fuel consumption of the new value versus the initial value.²⁸⁹

Some of the advanced²⁸⁹ engine technologies have values that indicate seemingly low effectiveness. Investigation of these values shows the low effectiveness is a result of applying the advanced engines to existing SHEVP2 architectures. This effect is expected and illustrates the importance of using the full vehicle modeling to

capture interactions between technologies and capture instances of both complimentary technologies and non-complimentary technologies. In this instance, the SHEVP2 powertrain improves fuel economy, in part, by allowing the engine to spend more time operating at efficient engine speed and load conditions. This reduces the

advantage of adding advanced engine technologies, which also improve fuel economy, by broadening the range of speed and load conditions for the engine to operate at high efficiency. This redundancy in fuel savings mechanism results in a lower effectiveness when the technologies are added to each other.

²⁸⁸ Technology key is the unique collection of technologies that constitutes a specific vehicle, see Section III.C.4.c).

²⁸⁹ The full data set we used to generate this example can be found in the FE_1 Improvements file.

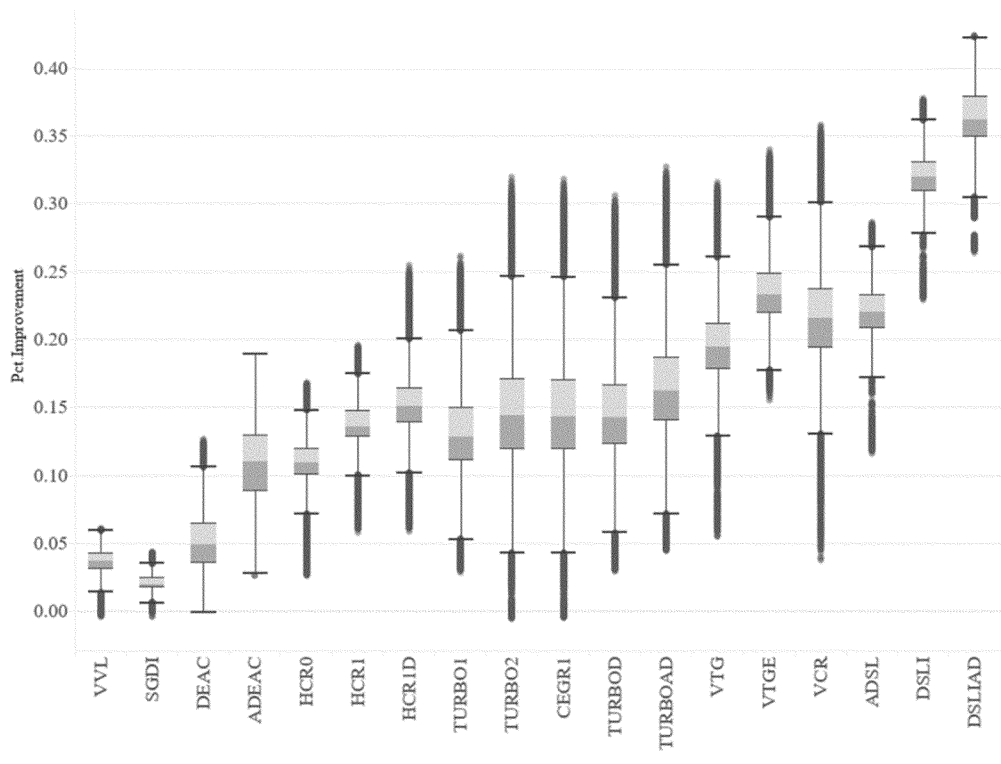

Figure III-9 – Engine Technologies Effectiveness Values for all Vehicle Technology Classes²⁹⁰

(e) Engine ²⁹⁰ Costs

We consider both cost and effectiveness in the CAFE Model when selecting any technology changes. As discussed in detail in TSD Chapter 3.1.8, the engine costs we use in this analysis build on estimates from the 2015 NAS Report, from agency-funded teardown studies, and from work performed by non-government organizations.²⁹¹

We use the absolute costs of the engine technology in this analysis, instead of relative costs used prior to the 2020 final rule. We use absolute costs to

ensure the full cost of the IC engine is removed when electrification technologies are applied, specifically for transition to BEVs. In this analysis, we model the cost of adopting BEV technology by first removing the costs associated with IC powertrain systems, then applying the BEV systems costs. Relative costs can still be determined through comparison of the absolute costs for the initial technology combination and the new technology combination.

As discussed in detail in TSD Chapter 3.1.8, we assigned engine costs based on

the number of cylinders in the engine and whether the engine is naturally aspirated or turbocharged and downsized. Table III-13 below shows an example of absolute costs for engine technologies in 2018\$. The example costs are shown for a straight 4-cylinder DOHC engine and V-6-cylinder DOHC engine. The table shows costs declining across successive years due to the learning rate we applied to each engine technology. For a full list of all absolute engine costs we used in the analysis across all model years, see the Technologies file.

²⁹⁰ The box shows the inner quartile range (IQR) of the effectiveness values and whiskers extend out 1.5 x IQR. The dots outside this range show effectiveness values outside those thresholds. The

data used to create this figure can be found in the FE_1 Improvements file.

²⁹¹ FEV prepared several cost analysis studies for EPA on subjects ranging from advanced 8-speed transmissions to belt alternator starters or start/stop

systems. NHTSA contracted Electricore, EDAG, and Southwest Research for teardown studies evaluating mass reduction and transmissions. The 2015 NAS Report also evaluated technology costs developed based on these teardown studies.

Table III-13 – Examples of Absolute Costs for Engine Technologies in 2018\$ for a Straight 4-Cylinder DOHC Engine and a V-6-Cylinder DOHC Engine for Select Model Years

Technology	4C1B Costs (2018\$)			6C2B Costs (2018\$)		
	MY 2020	MY 2025	MY 2030	MY 2020	MY 2025	MY 2030
EFR	66.61	63.97	57.83	99.92	95.96	86.74
VVT	5,205.13	5,201.71	5,199.02	6,059.15	6,052.31	6,046.93
VVL	5,402.62	5,393.28	5,385.95	6,298.29	6,284.28	6,273.28
SGDI	5,435.72	5,425.38	5,417.27	6,347.93	6,332.43	6,320.26
DEAC	5,268.59	5,263.27	5,259.08	6,040.39	6,034.11	6,029.18
TURBO1	6,228.96	6,179.91	6,152.15	7,073.58	7,020.02	6,989.71
TURBO2	6,807.16	6,644.50	6,538.33	7,673.21	7,498.58	7,384.60
CEGR1	7,221.06	7,019.17	6,887.39	8,087.11	7,873.26	7,733.67
ADEAC	6,292.36	6,217.71	6,174.57	7,633.14	7,521.16	7,456.45
HCR0	5,819.86	5,803.73	5,801.18	6,953.63	6,928.79	6,924.86
HCR1	5,863.02	5,833.12	5,825.45	6,996.80	6,958.18	6,949.13
HCR1D	6,040.68	6,005.45	5,993.60	7,206.43	7,161.53	7,147.55
VCR	7,370.02	7,208.71	7,124.07	8,214.65	8,048.82	7,961.63
VTG	7,592.44	7,380.16	7,241.61	8,457.91	8,234.25	8,088.26
VTGE	8,892.07	8,403.54	8,097.54	9,757.54	9,257.62	8,944.19
TURBOD	6,406.61	6,352.24	6,320.30	7,251.23	7,192.35	7,157.85
TURBOAD	6,971.41	6,861.47	6,801.38	7,816.03	7,701.57	7,638.93
ADSL	9,726.31	9,459.91	9,362.48	11,384.74	11,065.55	10,948.81
DSLI	10,226.67	9,931.51	9,823.56	12,036.41	11,679.77	11,549.33
DSLAD	10,791.47	10,440.74	10,304.64	12,883.61	12,443.61	12,270.94
CNG	11,822.52	11,612.31	11,471.76	12,676.54	12,462.91	12,319.67

We received several comments regarding engine technology costs. ICCT provided several cost comments for technologies including direct injection, cool exhaust gas recirculation, cylinder deactivation and turbo charging, that all took issue with the agency for not using cost data from a 2015 FEV teardown study.²⁹²

As we explained in the 2020 final rule, we do not believe that the FEV report referenced by ICCT is an appropriate source to use for this analysis for a few reasons. First, the primary focus of the FEV study “is the European Market according to the EU6b regulation as well as the consideration of emissions under both the NEDC and WLTP test procedures.” Components designed for use in Europe will have

²⁹² FEV 2015—David Blanco-Rodriguez, 2025 Passenger car and light commercial vehicle powertrain technology analysis. FEV GmbH. September 2015. https://theicct.org/sites/default/files/publications/PV-LCV-Powertrain-Tech-Analysis_FEV-ICCT_2015.pdf. (Accessed: February 16, 2022).

alternate constraints from parts designed for use in the U.S., such as octane limits, which can result in different designs and costs. This final rule analysis specifically considered the U.S. automotive market during the rulemaking timeframe based on U.S.-specific regulatory test cycles. Accordingly, the costs reflect incremental technology effectiveness for achieving improvements as measured through U.S. regulatory test methods. We discuss these test cycles and methods further in Section III.C.4.

Second, FEV did not conduct original teardown studies for this report, as indicated by project tasks, but rather used engineering judgement and external studies in assessing incremental costs.²⁹³ The FEV report did not provide sources for each individual cost and it is unclear how

²⁹³ FEV EU Costs Tasks: “Definition of reference hardware or description made by experience of development and design engineers as well as additional research as base for cost analysis (no purchase of hardware).”

costs in many scenarios were developed since no teardowns were used. Note that for this final rule analysis, we used previously conducted FEV cost teardown studies and the referenced 2015 NAS costs that also references FEV teardowns. As a result of this assessment we are not concluding that FEV as a whole is a source on which NHTSA should not rely, but we do want to make sure the baseline assumptions of costing data, and how they are collected, are consistent with the baseline assumptions of our analysis.

Finally, the cost for different vehicle classes identified by the FEV study does not line up with the vehicle classes discussed in the NPRM and this final rule analysis. FEV stated specifically, “the configuration of the vehicles has not been optimized for the [U.S.] market and may not be representative of this market.”²⁹⁴ We have discussed the importance of aligning the CAFE vehicle models with the U.S. market earlier in

²⁹⁴ *Id.* at p. 141.

Sections III.C.2 and III.C.4. All of these factors make it difficult to compare directly our estimates and estimates presented in the FEV report cited by ICCT in their comments.

ICCT's comment regarding the cost of the HCR engine technology costs, unlike the costs discussed above, did not originate with the 2015 FEV report. ICCT stated that "DMC costs for HCR in the SAFE rule, which are unchanged in NHTSA's proposed rule, were about \$200 more than in EPA's 2016 TAR. This is a clear case where the agencies appear to have not used the best available data from EPA."

We used the same DMCs established by the 2015 NAS Report for the Atkinson cycle technologies in both the NPRM analysis and the final rule analysis. However, because there are many various engine configurations in the market, we do not use the same fixed costs that were set for each type of vehicle described in the 2015 NAS Report, such as pickup and sedan. We have expanded costs by considering the type of technology in the baseline, like SGDI, and the configuration of the engine, such as SOHC versus DOHC. In addition, the cost used in the NPRM also included updated dollar year, learning rate, and RPE in comparison to the 2016 TAR. Although EPA also used costs from the 2015 NAS Report for the Proposed Determination analysis, they used a different approach to account for components.

After review of the provided comments, we continue to rely on the costs developed from the data provided by NAS and used for the NPRM analysis. Engine technology costs often exist as a range of values across manufacturers, and we work to try and find the best representative value of that range, avoiding either maximum or minimum values.

Transmission Paths

For this analysis, we classify all light duty vehicle transmission technologies into discrete transmission technology paths. We use these paths to model the most representative characteristics, costs, and performance of the fuel-economy improving transmissions most likely available during the rulemaking time frame, MYs 2024–2026.

In the following sections we discuss how we define transmission technologies in this analysis, the general technology categories we use in the CAFE Model, and the transmission technologies' relative effectiveness and costs. In the following sections we also provide an overview of how we assign transmission technologies to the baseline fleet, as well as the adoption

features, we apply to the transmission technologies.

We only received comments regarding the costs assigned to eCVT technology for power-split strong hybrid (*i.e.*, SHEVPS) systems. Our model only uses the eCVT technology as part of the SHEVPS technology package, and the eCVT is not modeled as a standalone transmission technology. As a result, we have responded to comments on eCVT costs in Section III.D.3. For all other transmission technologies, we use the same NPRM transmission technologies inputs and costs for the final rule analysis.

(a) Transmission Modeling in the CAFE Model

We model two categories of transmissions for this analysis: Automatic and manual. We characterize automatic transmissions as transmissions that automatically select and shift between transmission gears for the driver during vehicle operation. We further subdivide automatic transmissions into four subcategories: Traditional automatic transmissions (AT), dual clutch transmissions (DCT), continuously variable transmissions (CVT), and direct drive transmissions (DD).

We model both the DD transmission and eCVT as part of electrified powertrain technology packages, and not as independently selectable technologies. As a result, we do not explicitly include either technology in the transmission paths, and the technologies are discussed further in Section III.D.3.

We employ different levels of high efficiency gearbox (HEG) technology in the ATs and CVTs. HEG improvements for transmissions represent incremental advancement in technology that improve efficiency, such as reduced friction seals, bearings and clutches, super finishing of gearbox parts, and improved lubrication. These advancements are aimed at reducing frictional and other parasitic loads in transmissions, to improve efficiency. We consider three levels of HEG improvements in this analysis, based on 2015 NAS Report and CBI data.²⁹⁵ We apply HEG efficiency improvements to ATs and CVTs, because those transmissions inherently have higher friction and parasitic loads related to hydraulic control systems and greater component complexity, compared to MTs and DCTs. We note HEG technology improvements in the transmission technology pathways by increasing "levels" of a transmission

technology; for example, the baseline 8-speed automatic transmission is termed "AT8", while an AT8 with level 2 HEG technology is "AT8L2" and an AT8 with level 3 HEG technology is "AT8L3."

AT: Conventional planetary gear automatic transmissions are the most popular transmission.²⁹⁶ ATs typically contain three or four planetary gear sets that provide the various gear ratios. Gear ratios are selected by activating solenoids which engage or release multiple clutches and brakes as needed. ATs are packaged with torque converters, which provide a fluid coupling between the engine and the driveline and provide a significant increase in launch torque. When transmitting torque through this fluid coupling, energy is lost due to the churning fluid. These losses can be eliminated by engaging the torque convertor clutch to directly connect the engine and transmission ("lockup"). For the Draft TAR and 2020 final rule, EPA and DOT surveyed automatic transmissions in the market to assess trends in gear count and purported fuel economy improvements.²⁹⁷ Based on that survey, and also EPA's 2021 Automotive Trends Report,²⁹⁸ we concluded that modeling ATs with a range of 5 to 10 gears, with three levels of HEG technology for this analysis was reasonable.

CVT: Conventional continuously variable transmissions consist of two cone-shaped pulleys, connected with a belt or chain. Moving the pulley halves allows the belt to ride inward or outward radially on each pulley, effectively changing the speed ratio between the pulleys. This ratio change is smooth and continuous, unlike the step changes of other transmission varieties.²⁹⁹ We include two types of CVT systems in the selectable transmission paths, the baseline CVT and a CVT with HEG technology applied.

DCT: Dual clutch transmissions, like automatic transmissions, automate shift and launch functions. DCTs use separate clutches for even-numbered and odd-numbered gears, allowing the next gear needed to be pre-selected, resulting in faster shifting. The use of multiple clutches in place of a torque converter results in lower parasitic

²⁹⁶ 2021 EPA Automotive Trends Report, at pp. 62–66.

²⁹⁷ Draft TAR at 5–50, 5–51; Final Regulatory Impact Analysis accompanying the 2020 final rule, at 549.

²⁹⁸ 2021 EPA Automotive Trends Report, at pp. 62–66.

²⁹⁹ 2015 NAS Report, at p. 171.

²⁹⁵ 2015 NAS Report, at p. 191.

losses than ATs.³⁰⁰ Because of a history of limited appeal,³⁰¹ ³⁰² we constrain application of additional DCT technology to vehicles already using DCT technology, and only model two types of DCTs in this analysis.

MT: Manual transmissions are transmissions that require direct control by the driver to operate the clutch and shift between gears. In a manual transmission, gear pairs along an output shaft and parallel layshaft are always

engaged. Gears are selected via a shift lever, operated by the driver. The lever operates synchronizers, which speed match the output shaft and the selected gear before engaging the gear with the shaft. During shifting operations (and during idle), a clutch between the engine and transmission is disengaged to decouple engine output from the transmission. Automakers today offer a minimal selection of new vehicles with manual transmissions.³⁰³ As a result of

reduced market presence, we only include three variants of manual transmissions in the analysis.

The transmission model paths used in this analysis are shown in Figure III–10. Baseline-only technologies (MT5, AT5, AT7L2, AT9L2, and CVT) are grayed and can only be assigned as initial vehicle transmission configurations. Further details about transmission path modeling can be found in TSD Chapter 3.2.

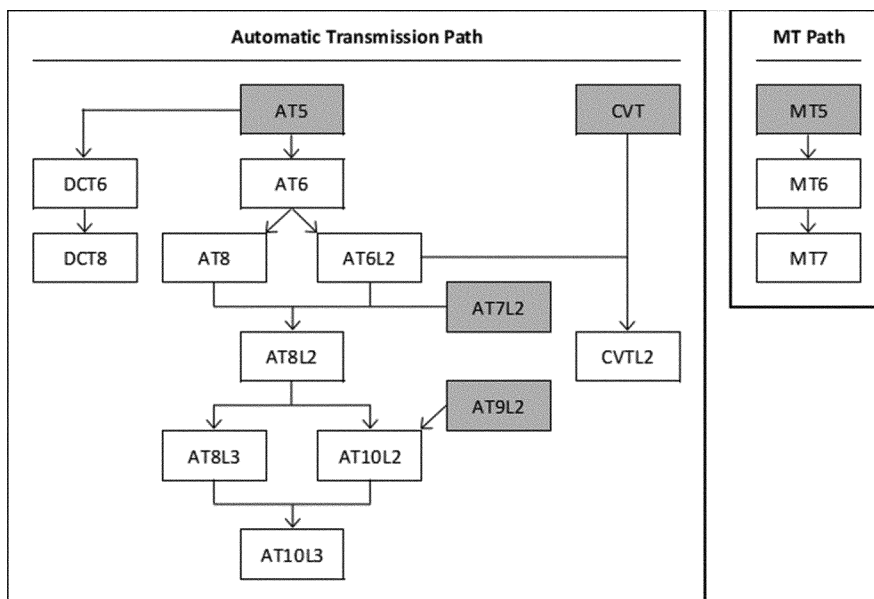

Figure III-10 – CAFE Model Pathways for Transmission Technologies

(b) Transmission Analysis Fleet Assignments

The wide variety of transmissions on the market are classified into discrete transmission technology paths for this analysis. These paths are used to model the most representative characteristics, costs, and performance of the fuel economy-improving technologies most likely available during the rulemaking time frame.

To generate the analysis fleet, we gather data on transmissions from manufacturer mid-model year CAFE compliance submissions and publicly available manufacturer specification sheets. We use the data to assign transmissions in the analysis fleet and determine which platforms share transmissions.

We specify transmission type, number of gears, and high-efficiency gearbox (HEG) level for the baseline fleet assignment. The number of gears in the

assignments for automatic and manual transmissions usually match the number of gears listed by the data sources, with some exceptions. We did not model four-speed transmissions in Autonomie for this analysis due to their rarity and low likelihood of being used in the future, so we assigned MY 2020 vehicles with an AT4 or MT4 to an AT5 or MT5 baseline, respectively. Some dual-clutch transmissions were also an exception; dual-clutch transmissions with seven gears were assigned to DCT6.

For automatic and continuously variable transmissions, the identification of the most appropriate transmission path model required additional steps; this is because high-efficiency gearboxes are considered in the analysis but identifying HEG level from specification sheets alone was not always straightforward. We conducted a review of the age of the transmission design, relative performance versus previous designs, and technologies

incorporated and used the information obtained to assign an HEG level. No automatic transmissions in the analysis fleet were determined to be at HEG Level 3. In addition, no six-speed automatic transmissions were assigned HEG Level 2. However, we found all 7-speed, all 9-speed, all 10-speed, and some 8-speed automatic transmissions to be advanced transmissions operating at HEG Level 2 equivalence. Eight-speed automatic transmissions developed after MY 2017 are assigned HEG Level 2. All other transmissions are assigned to their respective transmission's baseline level. The baseline (HEG level 1) technologies available include AT6, AT8, and CVT.

We assigned any vehicle in the analysis fleet with an electric powertrain a direct drive (DD) transmission. This designation is for informational purposes; if specified, the transmission will not be replaced or updated by the model. Similarly, we assigned any power-split hybrid vehicle

³⁰⁰ 2015 NAS Report, at p. 170.

³⁰¹ 2020 EPA Automotive Trends Report, at p. 57.

³⁰² 2021 NAS Report, at 56.

³⁰³ 2020 EPA Automotive Trends Report, at p. 61.

an eCVT transmission. As with the direct drive (DD) transmission, this designation is for informational purposes.

In addition to technology type, gear count, and HEG level, transmissions are characterized in the analysis fleet by drive type and vehicle architecture. Drive types considered in the analysis include front-, rear-, all-, and four-wheel drive. Our definition of drive types in the analysis does not always align with manufacturers' drive type designations; see the end of this subsection for further discussion. These characteristics, supplemented by information such as gear ratios and production locations, showed that manufacturers use transmissions that are the same or similar on multiple vehicle models. Manufacturers have told the agency they do this to control component complexity and associated costs for development, manufacturing, assembly, and service. If multiple vehicle models share technology type, gear count, drive configuration, internal gear ratios, and production location, the transmissions are treated as a single group for the analysis. Vehicles in the analysis fleet with the same transmission configuration adopt additional fuel-saving transmission technology together, as described in Section III.C.2.a).

Shared transmissions are designated and tracked in the CAFE Model input files using transmission codes. Transmission codes are six-digit numbers that are assigned to each transmission and encode information about them. This information includes the manufacturer, drive configuration, transmission type, and number of gears. TSD Chapter 3.2.4 includes more information on the transmission codes designated in the analysis fleet.

We assigned different transmission codes to variants of a transmission that may have appeared to be similar based on the characteristics considered in the analysis but are not mechanically identical. We distinguish among transmission variants by comparing their internal gear ratios and production locations. For example, several Ford nameplates carry a rear-wheel drive, 10-speed automatic transmission. These nameplates comprise a wide variety of body styles and use cases, and so we assigned different transmission codes to these different nameplates. Because we assigned different transmission codes, we are not treating them as "shared" for the purposes of the analysis and the transmission models have the opportunity to adopt transmission technologies independently.

Note that when we determine the drive type of a transmission, the assignment of all-wheel drive (AWD) versus four-wheel drive (4WD) is determined by vehicle architecture. Our assignment does not necessarily match the drive type used by the manufacturer in specification sheets and marketing materials. We assigned vehicles with a powertrain capable of providing power to all wheels and a transverse engine (front-wheel drive architecture), AWD. We assigned vehicles with power to all four wheels and a longitudinal engine (rear-wheel drive architecture), 4WD.

(c) Transmission Adoption Features

We designated transmission technology pathways to prevent "branch hopping"—changes in transmission type that would correspond to significant changes in transmission architecture—for vehicles that are relatively advanced on a given pathway. The CAFE Model prevents "branch hopping" recognizing that stranded capital associated with moving from one transmission architecture to another is relevant and not entirely feasible when making technology selections. Stranded capital is discussed in Section III.C.6. For example, a vehicle with an automatic transmission with more than five gears cannot adopt a dual-clutch transmission. For a more detailed discussion of path logic applied in the analysis, including technology supersession logic and technology mutual exclusivity logic, please see CAFE Model Documentation S4.5 Technology Constraints (Supersession and Mutual Exclusivity).

Some technologies modeled in the analysis are not yet in production, and therefore are not assigned in the baseline fleet. Nonetheless, we made these technologies available for future adoption because, they are projected to be available in the analysis timeframe. For instance, we did not observe an AT10L3 in the baseline fleet, but it is plausible that manufacturers that employ AT10L2 technology may improve the efficiency of those AT10L2s in the rulemaking timeframe.

In the following sections we discuss specific adoption features applied to each type of transmission technology.

When we adopt electrification technologies, the transmissions associated with those technologies will supersede the existing transmission on a vehicle. We superseded the transmission technology when P2 hybrids, plug-in hybrids, or battery electric vehicle technologies are applied. For more information, see Section III.D.3.c).

We preclude adoption of other transmission types once a platform progresses past an AT6 on the automatic transmission path. We use this restriction to avoid the significant level of stranded capital loss that could result from adopting a completely different transmission type shortly after adopting an advanced transmission, which would occur if a different transmission type were adopted after AT6 in the rulemaking timeframe.

We do not allow vehicles that do not start with AT7L2 or AT9L2 transmissions to adopt those technologies during simulation. We observed that MY 2020 vehicles with those technologies were primarily luxury performance vehicles and concluded that other vehicles would likely not adopt those technologies. We concluded that this was also a reasonable assumption for the analysis fleet because vehicles that have moved to more advanced automatic transmissions have overwhelmingly moved to 8-speed and 10-speed transmissions.³⁰⁴

We limited CVT adoption by technology path logic. We do not allow CVTs to be adopted by vehicles that do not originate with a CVT or by vehicles with multispeed transmissions beyond AT6 in the baseline fleet. Once on the CVT path, we only allow the platform to apply improved CVT technologies. We restrict application of CVT technology on larger vehicles because of the higher torque (load) demands of those vehicles and CVT torque limitations based on durability constraints. Additionally, we use this restriction to avoid the loss of significant level of stranded capital.

We allow vehicles in the baseline fleet that have DCTs to apply an improved DCT and allows vehicles with an AT5 to consider DCTs. Drivability and durability issues with some DCTs have resulted in a low relative adoption rate over the last decade; this is also broadly consistent with manufacturers' technology choices.³⁰⁵

We only allow vehicles with MTs to adopt more advanced manual transmissions for this analysis, because other transmission types do not provide a similar driver experience (utility). We do not allow vehicles with MTs to adopt ATs, CVTs, or DCT technologies under any circumstance. We do not allow vehicles with other transmissions to adopt MTs in recognition of the low

³⁰⁴ 2020 EPA Automotive Trends Report, at 64, figure 4.18.

³⁰⁵ *Ibid.*

customer demand for manual transmissions.³⁰⁶

(d) Transmission Effectiveness Modeling

For this analysis, we use the Autonomie full vehicle simulation tool to model the interaction between transmissions and the full vehicle system to improve fuel economy, and how changes to the transmission subsystem influence the performance of the full vehicle system. Our full vehicle simulation approach clearly defines the contribution of individual transmission technologies and separates those contributions from other technologies in the full vehicle system. Our modeling approach follows the recommendations of the 2015 NAS Report to use full vehicle modeling supported by application of collected improvements at the sub-model level.³⁰⁷ See TSD Chapter 3.2.4 for more details on transmission modeling inputs and results.

The only technology effectiveness results that were not directly calculated using the Autonomie simulation results were for the AT6L2. We determined the model for this specific technology was inconsistent with the other transmission models and overpredicted effectiveness results. Evaluation of the AT6L2 transmission model revealed an overestimated efficiency map was developed for the AT6L2 model. The high level of efficiency assigned to the transmission surpassed benchmarked advanced transmissions.³⁰⁸ To address the issue, we replaced the effectiveness values of the AT6L2 model. We replaced the effectiveness for the AT6L2 technology with analogous effectiveness values from the AT7L2 transmission model. For additional discussion on how analogous effectiveness values are determined please see Section III.D.1.d)(2).

The effectiveness values for the transmission technologies, for all ten vehicle technology classes, are shown in Figure III-11. Each of the effectiveness

values shown is representative of the improvements seen for upgrading only the listed transmission technology for a given combination of other technologies. In other words, the range of effectiveness values we show for each specific technology, e.g., AT10L3, represents the addition of the AT10L3 technology to every technology combination that could select the addition of AT10L3. We must emphasize that the graph shows the change in fuel consumption values between entire technology keys,³⁰⁹ and not the individual technology effectiveness values. Using the change between whole technology keys captures the complementary or non-complementary interactions among technologies. In the graph, the box shows the inner quartile range (IQR) of the effectiveness values and whiskers extend out $1.5 \times$ IQR. The dots outside of the whiskers show values for effectiveness that are outside these bounds.

BILLING CODE 4510-59-P

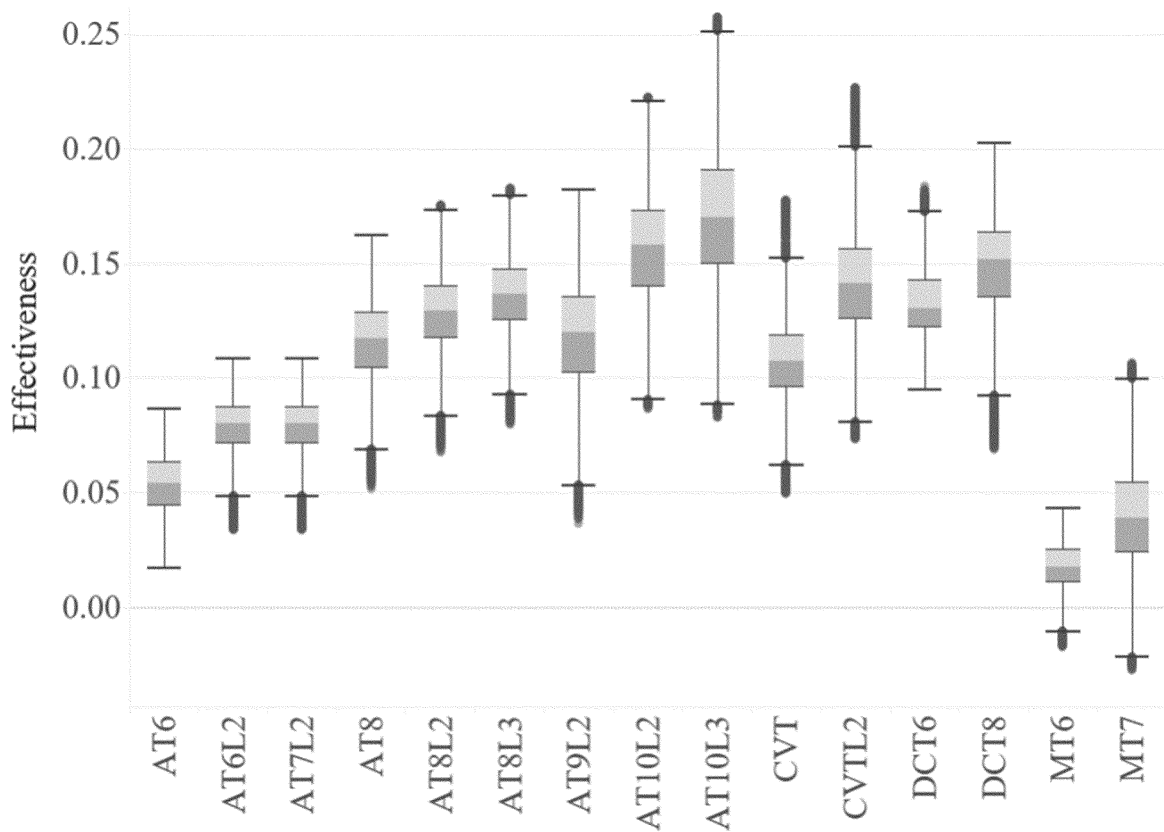

Figure III-11 – Transmission Technologies Effectiveness Values for all Vehicle Technology Classes³¹⁰

³⁰⁶ Ibid.

³⁰⁷ 2015 NAS Report, at p. 292.

³⁰⁸ Autonomie model documentation, Chapter 5.3.4, Transmission Performance Data.

³⁰⁹ Technology key is the unique collection of technologies that constitutes a specific vehicle, see Section III.C.4.c).

We also want to note the effectiveness for the MT5, AT5, eCVT and DD technologies are not shown. The DD and eCVT do not have standalone effectiveness values because they are only implemented as part of electrified powertrains. The MT5 and AT5 also have no effectiveness values because both technologies are baseline technologies against which all other technologies are compared.

(e) Transmission Costs

We use transmission costs drawn from several sources, including the 2015 NAS Report and NAS-cited studies for this analysis. TSD Chapter 3.2.7 provides a detailed description of the cost sources used for each transmission technology. In Table III–14 we show an example of absolute costs for transmission technologies in 2018\$

across select model years, which demonstrates how we applied cost learning to the transmission technologies over time. Note, because transmission hardware is often shared across vehicle classes, transmission costs are the same for all vehicle classes. For a full list of all absolute transmission costs used in the analysis across all model years, see the Technologies file.

Table III-14 – Examples of Absolute Costs for Transmission Technologies in 2018\$ for Select Model Years

Technology	MY 2020	MY 2025	MY 2030
MT5	1,563.97	1,563.97	1,563.97
MT6	1,928.41	1,917.08	1,910.70
MT7	2,226.75	2,100.64	2,034.88
AT5	2,085.30	2,085.30	2,085.30
AT6	2,063.19	2,063.19	2,063.19
AT6L2	2,331.44	2,303.65	2,293.25
AT7L2	2,298.63	2,276.53	2,268.26
AT8	2,195.36	2,195.18	2,195.15
AT8L2	2,442.32	2,405.33	2,391.49
AT8L3	2,649.15	2,590.74	2,568.89
AT9L2	2,546.03	2,498.29	2,480.43
AT10L2	2,546.03	2,498.29	2,480.43
AT10L3	2,753.44	2,684.21	2,658.31
DCT6	2,115.89	2,115.84	2,115.84
DCT8	2,653.91	2,653.15	2,653.02
CVT	2,332.83	2,322.63	2,315.25
CVTL2	2,518.80	2,500.94	2,488.02

3. Electrification Paths

The electric paths include a large set of technologies that share the common element of using electrical power for certain vehicle functions that were traditionally powered mechanically by IC engines. Electrification technologies thus can range from electrification of specific accessories (for example, electric power steering to reduce engine loads by eliminating parasitic losses) to electrification of the entire powertrain (as in the case of a battery electric vehicle).

The following subsections discuss how we define each electrification technology in the CAFE Model and the

electrification pathways down which a vehicle can travel in the compliance simulation. The subsections also discuss how we assigned electrified vehicle technologies to vehicles in the analysis fleet, any limitations on electrification technology adoption, and the specific effectiveness and cost assumptions that we use in the Autonomie and CAFE Model analysis.

We received many comments on electrification technologies, and specifically on technology costs. Commenters were generally supportive of our use of Argonne’s BatPaC battery cost model to determine costs of batteries for different electrified

powertrains.³¹¹ In contrast, we received several comments indicating that we overstated the cost for hybrid vehicles and batteries,³¹² in particular due to non-battery electrification component costs. These comments and our approach to addressing them for this final rule are discussed in the following sections.

Electrification technologies are a complex set of systems that each manufacturer individually optimizes based on cost, performance, reliability, durability, customer acceptance and other metrics. We attempted to capture these complexities to provide a reasonable assessment of the costs and

³¹⁰ The data used to create this figure can be found the FE_1 Improvements file.

³¹¹ Auto Innovators, Docket No. NHTSA–2021–0053–0021, at 55; Kia, Docket No. NHTSA–2021–0053–1525, at p. 5.

³¹² Tesla, Inc. (Tesla), Docket No. NHTSA–2021–0053–1480, at 9–10; Toyota, Docket No. NHTSA–2021–0053–1568, at 7; ICCT, Docket No. NHTSA–2021–0053–1581, at p. 10.

benefits of more stringent fuel economy standards. We expect that there will be future opportunities to improve upon this work as more substantiated data on electrification technologies becomes available.

(a) Electrification Modeling in the CAFE Model

The CAFE Model defines the technology pathway for each type of electrification grouping in a logical progression. Whenever the CAFE Model converts a vehicle model to one of the available electrified systems, both effectiveness and costs are updated according to the specific components' modeling algorithms. Additionally, all technologies on the electrification paths

are mutually exclusive and are evaluated in parallel. For example, the model may evaluate PHEV20 technology prior to having to apply SS12V or strong hybrid technology. The specific set of algorithms and rules are discussed further in the sections below, and more detailed discussions are included in the CAFE Model Documentation. The specifications for each electrification technology that we include in the analysis is discussed below.

The technologies that we include on the three vehicle-level paths pertaining to the electrification and electric improvements defined within the modeling system are illustrated in Figure III-12. As shown in the Electrification path, the baseline-only

CONV technology is grayed out. This technology is used to denote whether a vehicle comes in with a conventional powertrain (*i.e.*, a vehicle that does not include any level of hybridization) and to allow the model to properly map to the Autonomie vehicle simulation database results. If multiple technologies from different pathways come together on single technology set, then those previous technology pathways are disabled. This avoids unrealistic adoption of legacy technologies as the simulation progresses from model year to model year. For example, in the Figure III-12 PHEVs converge on to BEVs then all the PHEVs are disabled from adoption.

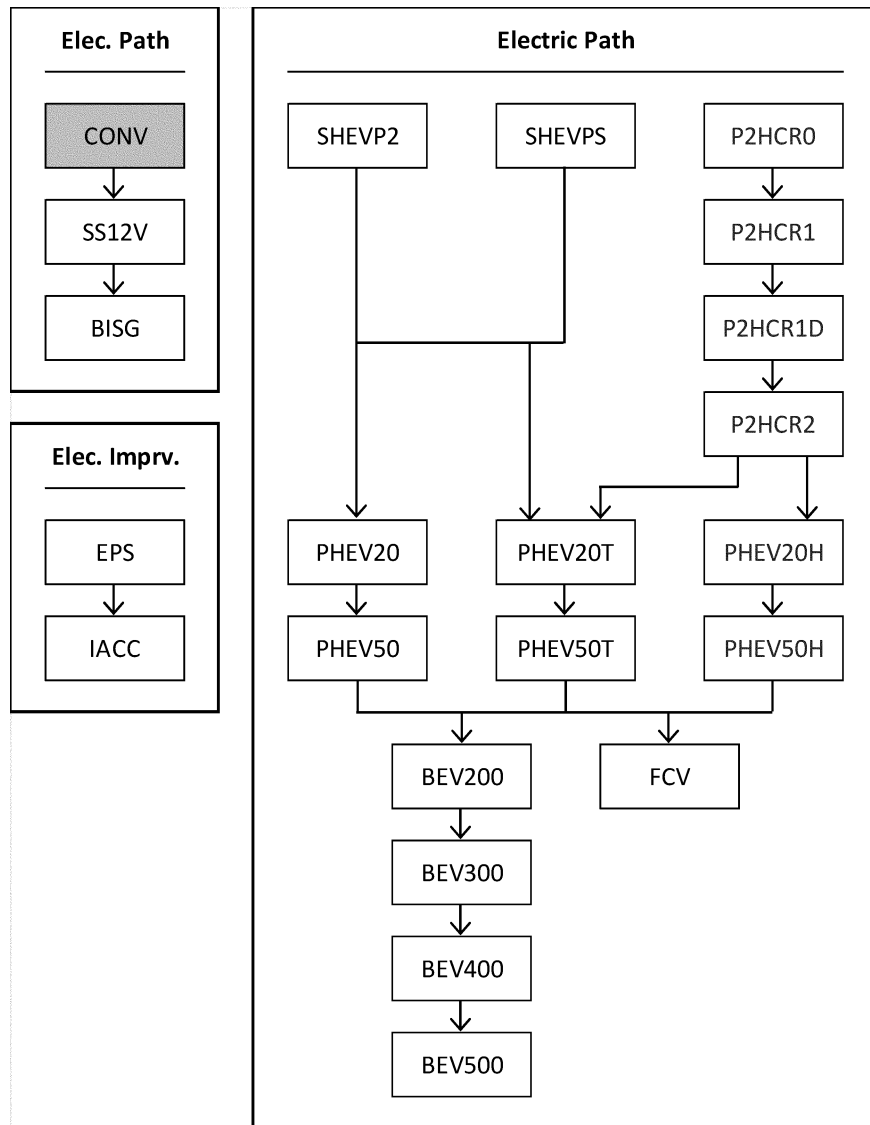

Figure III-12 – Electrification Paths in the CAFE Model

SS12V: 12-volt stop-start (*SS12V*), sometimes referred to as start-stop, idle-stop, or a 12-volt micro hybrid system, is the most basic hybrid system that facilitates idle-stop capability. In this system, the integrated starter generator is coupled to the internal combustion (IC) engine. When the vehicle comes to an idle-stop the IC engine completely shuts off, and, with the help of the 12-volt battery, the engine cranks and starts again in response to throttle to move the vehicle, application or release of the brake pedal to move the vehicle. The 12-volt battery used for the start-stop system is an improved unit compared to a traditional 12-volt battery, and is capable of higher power, increased life cycle, and capable of minimizing voltage drop on restart. This technology is beneficial to reduce fuel consumption and emissions when the vehicle frequently stops, such as in city driving conditions or in stop and go traffic. *SS12V* can be applied to all vehicle technology classes. As discussed further below, for this final rule analysis we lowered the cost of the battery used in the *SS12V* system to reflect a more widely utilized *SS12V* battery chemistry.

Next, mild and strong hybrid systems, discussed in the following paragraphs, can be classified based on the location of the electric motor in the system. Depending on the location of the electric machine, the hybrid technologies are classified as follows:

- P0: Motor located at the primary side of the engine,
- P1: Motor located at the flywheel side of the engine,
- P2: Motor located between engine and transmission,
- P3: Motor located at the transmission output, and
- P4: Motor located on the axle.

BISG: The belt integrated starter generator, sometimes referred to as a mild hybrid system or P0 hybrid, provides idle-stop capability and uses a higher voltage battery with increased energy capacity over conventional automotive batteries. These higher voltages allow the use of a smaller, more powerful, and efficient electric motor/generator to replace the standard alternator. In *BISG* systems, the motor/generator is coupled to the engine via belt (similar to a standard alternator). In addition, these motor/generators can assist vehicle braking and recover braking energy while the vehicle slows down (regenerative braking) and in turn can propel the vehicle at the beginning of launch, allowing the engine to be restarted later. Some limited electric assist is also provided during acceleration to improve engine

efficiency. Like micro hybrids, *BISG* can be applied to all vehicles in the analysis except for Engine 26a (VCR). We assume all mild hybrids are fixed battery capacity 48-volt systems with engine belt-driven motor/generators.

ICCT commented that we should consider another type of mild hybrid system that has a higher power output, which leads to an increased efficiency compared to the 48V mild hybrid assumed in the NPRM analysis. The increased benefit from this higher power output mild hybrids is due to its placement in the powertrain in P1 and P2 positions rather than P0.^{313 314}

We agree with ICCT that mild hybrids in configurations other than the P0 position offer higher improvements compared to mild hybrids configured in the P0 position. However, this inherently increases the cost of the system and makes the system less cost effective compared to traditional strong hybrids for a few reasons. First, like a mild hybrid *CISG* system,³¹⁵ non-P0 mild hybrid architecture requires significant changes to the area of the powertrain where the electric machine components are installed compared to P0 *BISG* systems. Second, these system's higher power output will also require a higher battery pack capacity, which could also increase costs. Separately, no manufacturer has indicated that they will adopt this type of mild hybrid configuration in the rulemaking time frame. For MYs 2024–2026, the CAFE Model estimates that a significant penetration of strong hybrids and plug-in hybrids is required to meet the analyzed alternatives. Similar to what we observed in past rulemakings with the *CISG* system, the non-P0 mild hybrid is not a cost-effective way for manufacturers to meet standards in the rulemaking time frame. Accordingly, we did not add an additional mild hybrid technology for this final rule.

SHEVP2/SHEVPS: A strong hybrid vehicle is a vehicle that combines two or more propulsion systems, where one uses gasoline (or diesel), and the other captures energy from the vehicle during deceleration or braking, or from the engine and stores that energy for later used by the vehicle. This analysis evaluated the following strong hybrid systems: hybrids with P2 parallel drivetrain architectures (*SHEVP2*), and hybrids with power-split architectures (*SHEVPS*). Both strong hybrid types provide start-stop or idle-stop

functionality, regenerative braking capability, and vehicle launch assist. A *SHEVPS* has a higher potential for fuel economy improvement than a *SHEVP2*, although it costs more and has a lower power density.³¹⁶

P2 parallel hybrids (*SHEVP2*) are a type of hybrid vehicle that use a transmission-integrated electric motor placed between the engine and a gearbox or CVT, with a clutch that allows decoupling of the motor/transmission from the engine. Disengaging the clutch allows all-electric operation and more efficient brake-energy recovery. Engaging the clutch allows coupling of the engine and electric motor and, when combined with a transmission, reduces gear-train losses relative to power-split or 2-mode hybrid systems. P2 hybrid systems typically rely on the internal combustion engine to deliver high, sustained power levels. Electric-only mode is used when power demands are low or moderate.

An important feature of the *SHEVP2* system is that it can be applied in conjunction with most engine technologies. Accordingly, once a vehicle is converted to a *SHEVP2* powertrain in the compliance simulation, the CAFE Model allows the vehicle to adopt the conventional engine technology that is most cost effective, regardless of relative location of the existing engine on the engine technology path. This means a vehicle could adopt a lower technology engine when the CAFE Model converts it to a *SHEVP2* strong hybrid. For example, a vehicle in the analysis fleet that starts with a *TURBO2* engine could adopt a *TURBO1* engine with the *SHEVP2* system, if that *TURBO1* engine allows the vehicle to meet fuel economy standards more cost effectively.

The power-split hybrid (*SHEVPS*) is a more advanced electrified system than *SHEVP2* hybrid. The *SHEVPS* electric drive replaces the traditional transmission with a single planetary gear set (the power-split device) and a motor/generator.³¹⁷

Table III–15 below shows the configuration of conventional engines and transmissions used with strong hybrids for this analysis. The *SHEVPS* powertrain configuration is paired with a planetary transmission (eCVT) and Atkinson engine (Eng26). This configuration is designed to maximize efficiency at the cost of reduced towing

³¹³ ICCT, at p. 2.

³¹⁴ Autonomie assumes a P0 position for mild hybrid 48-volt systems.

³¹⁵ We discuss challenges with *CISG* mild hybrids, a system that is similar to the P2 hybrid system, further in TSD Chapter 3.3.1.2.

³¹⁶ Kapadia, J., Kok, D., Jennings, M., Kuang, M. et al., "Powersplit or Parallel—Selecting the Right Hybrid Architecture," SAE Int. J. Alt. Power. 6(1):2017, doi:10.4271/2017-01-1154.

³¹⁷ For more discussion of *SHEVPS* operation and characteristics, see TSD Section 3.3.

capability and real-world acceleration performance.³¹⁸ In contrast, SHEVP2

powertrains are paired with an advanced 8-speed automatic

transmission (AT8L2) and can be paired with most conventional engines.³¹⁹

Table III-15 – Configuration of Strong Hybrid Architectures with Transmissions and Engines

CAFE Model Technologies	Transmission Options	Engine Options (PC/SUV)	Engine Options (LT)
SHEVPS	Planetary - eCVT	Eng 26 - Atkinson	N/A
SHEVP2 ³²⁰	AT8L2	All engines except for VTGe and VCR	All engines except for VTGe and VCR

PHEV: Plug-in hybrid electric vehicles are hybrid electric vehicles with the means to charge their battery packs from an outside source of electricity (usually the electric grid). These vehicles have larger battery packs than strong HEVs with more energy storage and a greater capability to be discharged than other non-plug-in hybrid electric vehicles. PHEVs also generally use a control system that allows the battery pack to be substantially depleted under electric-only or blended mechanical/electric operation and batteries that can be cycled in charge-sustaining operation at a lower state of charge than non-plug-in hybrid electric vehicles. These vehicles generally have a greater all-electric range than typical strong HEVs. Depending on how these vehicles are operated, they can use electricity exclusively, operate like a conventional hybrid, or operate in some combination of these two modes.

There are four PHEV architectures included in this analysis that reflect combinations of two levels of all-electric

range (AER) and two engine types. We use 20 miles AER and 50 miles AER to reasonably span the various PHEV AERs in the market, and their effectiveness and cost. We use an Atkinson engine and a turbocharged downsized engine to span the variety of engines available in the market.

PHEV20/PHEV20H and PHEV50/PHEV50H are essentially a SHEVPS with a larger battery and the ability to drive with the engine turned off. In the CAFE Model, the designation “H” in PHEVxH could represent another type of engine configuration, but for this analysis we use the same effectiveness values as PHEV20 and PHEV50 to represent PHEV20H and PHEV50H, respectively. The PHEV20/PHEV20H represents a “blended-type” plug-in hybrid that can operate in all-electric (engine off) mode only at light loads and low speeds, and must blend electric motor and engine power together to propel the vehicle at medium or high loads and speeds. The PHEV50/PHEV50H represents an extended range

electric vehicle (EREV) that can travel in all-electric mode even at higher speeds and loads. Engine sizing, batteries, and motors for these PHEVs are discussed further in Section III.D.3.d).

PHEV20T and PHEV50T are 20 mile and 50 mile AER vehicles based on the SHEVP2 engine architecture. The PHEV versions of these architectures include larger batteries and motors to meet performance metrics in charge sustaining mode at higher speeds and loads as well as similar performance and range in all electric mode in city driving and at higher speeds and loads. For this analysis, the CAFE Model considers these PHEVs to have an advanced 8-speed automatic transmission (AT8L2) and TURBO1 (Eng12) in the powertrain configuration. Further discussion of engine sizing, batteries, and motors for these PHEVs is discussed in Section III.D.3.d).

Table III–16 shows the different PHEV configurations used in this analysis.

³¹⁸ Kapadia, J., D. Kok, M. Jennings, M. Kuang, B. Masterson, R. Isaacs, A. Dona. 2017. Powersplit or Parallel—Selecting the Right Hybrid Architecture. SAE International Journal of Alternative

Powertrains 6 (1): 68–76. <https://doi.org/10.4271/2017-01-1154> (accessed: Feb. 11, 2022).

³¹⁹ We did not model SHEVP2s with VTGe (Eng23c) and VCR (Eng26a).

³²⁰ Twenty-one different engines are evaluated with SHEVP2 hybrid architecture: Engine 01, 02, 03, 04, 5b, 6a, 7a, 8a, 12, 12–DEAC, 13, 14, 17, 18, 19, 20, 21, 22b, 23b, 24, 24–Dec. See Section III.D.1 for these engine specifications.

Table III-16 – Configuration of Plug-in Hybrid Architectures with Transmissions and Engines

CAFE Model Technologies	Transmission Options	Engine Options (PC/SUV)	Engine Options (LT)
PHEV20/PHEV20H	Planetary - eCVT	Eng 26 - Atkinson Engine	N/A
PHEV20T	AT8L2	Eng 12 - TURBO1	Eng 12 - TURBO1
PHEV50/PHEV50H	Planetary - eCVT	Eng 26 - Atkinson	N/A
PHEV50T	AT8L2	Eng 12 - TURBO1	Eng 12 - TURBO1

BEV: Battery electric vehicles are equipped with all-electric drive systems powered by energy-optimized batteries charged primarily by electricity from the grid. BEVs do not have a combustion engine or traditional transmission. Instead, BEVs rely on all electric powertrains with a single speed gear reduction in place of an advanced transmission. Battery electric vehicle range varies by vehicle and battery pack size.

We simulate BEVs with ranges of 200, 300, 400 and 500 miles in the CAFE Model. BEV range is measured pursuant to EPA test procedures and guidance.³²¹ The CAFE Model assumes a BEV direct drive transmission is unique to each vehicle (*i.e.*, the transmissions are not shared by any other vehicle) and that no further improvements to the transmission are available.

An important note about the BEVs offered in this analysis is that the CAFE Model does not account for vehicle range when considering additional BEV technology adoption. That is, the CAFE Model does not have an incentive to build BEV 300, 400, and 500s, because the BEV200 is just as efficient as those vehicles and counts the same toward compliance, but at a significantly lower cost because of the smaller battery.³²² While manufacturers have been building 200-mile range BEVs, those vehicles have generally been passenger

cars. Manufacturers have told us that greater range is important for meeting the needs of broader range of consumers and to increase consumer demand. More recently, there has been a trend towards manufacturers building higher range BEVs in the market, and manufacturers building CUV/SUV and pickup truck BEVs.³²³ To simulate the potential relationship of BEV range to consumer demand, we have included several adoption features for BEVs. These are discussed further in Section III.D.3.c).

FCEV: Fuel cell electric vehicles are equipped with an all-electric drivetrain, but unlike BEVs, FCEVs do not solely rely on batteries; rather, electricity to run the FCEV electric motor is mainly generated by an onboard fuel cell system. FCEV architectures are similar to series hybrids,³²⁴ but with the engine and generator replaced by a fuel cell. Commercially available FCEVs consume hydrogen to generate electricity for the fuel cell system, with most automakers using high pressure gaseous hydrogen storage tanks. FCEVs are currently produced in limited numbers and are available in limited geographic areas where hydrogen refueling stations are accessible. For reference, in MY 2020, only four FCEV models were offered for sale, and since 2014 only 12,081 FCEVs have been sold.^{325 326 327}

For this analysis, the CAFE Model simulates a FCEV with a range of 320

miles. Any powertrain type can adopt a FCEV powertrain; however, to account for limited market penetration and unlikely increased adoption in the rulemaking timeframe, technology phase in caps are used to control how many FCEVs a manufacturer can build. The details of this concept are further discussed in Section III.D.3.c).

(b) Electrification Analysis Fleet Assignments

We use electrification technologies assigned in the baseline fleet as the starting point for regulatory analysis. These assignments are based on manufacturer-submitted CAFE compliance information, publicly available technical specifications, marketing brochures, articles from reputable media outlets, and data from Wards Intelligence.³²⁸

Table III–17 gives the penetration rates of electrification technologies eligible to be assigned in the baseline fleet. Over half of the fleet had some level of electrification, with the vast majority of these being micro hybrids. PHEVs represented 0.5 percent of the MY 2020 baseline fleet. BEVs represented less than 2 percent of MY 2020 baseline fleet; BEV300 was the most common BEV technology, while no BEV500s were observed.

³²¹ BEV electric ranges are determined per EPA guidance Document. “EPA Test Procedure for Electric Vehicles and Plug-in Hybrids.” <https://fuelconomy.gov/feg/pdfs/EPA%20test%20procedure%20for%20EVs-PHEVs-11-14-2017.pdf>. November 14, 2017. (Accessed: May 3, 2021)

³²² See section III.D.3.d Electrification Effectiveness Modeling for effectiveness of different range BEVs.

³²³ 2021 EPA Automotive Trends Report, at p. 58.

³²⁴ Series hybrid architecture is a strong hybrid that has the engine, electric motor and transmission in series. The engine in a series hybrid drives a generator that charges the battery.

³²⁵ Argonne National Laboratory, “Light Duty Electric Drive Vehicles Monthly Sales Update.” Energy Systems Division, <https://www.anl.gov/es/light-duty-electric-drive-vehicles-monthly-sales-updates>. (Accessed: Dec. 15, 2021)

³²⁶ See the MY 2020 Market Data file. The four vehicles are the Honda Clarity, Hyundai Nexa and Nexa Blue, and Toyota Mirai.

³²⁷ These are majority leased vehicles that are returned back to the manufacturer rather than resold as a used vehicle.

³²⁸ “U.S. Car and Light Truck Specifications and Prices, '20 Model Year.” *Wards Intelligence*, 3 Aug. 2020, wardsintelligence.informa.com/WI964244/US-Car-and-Light-Truck-Specifications-and-Prices-20-Model-Year (accessed: Feb. 11, 2022).

Table III-17 – Penetration Rate of Electrification Technologies in the MY 2020 Fleet

Electrification Technology	Sales Volume with this Technology	Penetration Rate in 2020 Baseline Fleet
None	5,791,220	42.61%
SS12V	6,837,257	50.30%
BISG	258,629	1.90%
SHEVP2	6,409	0.05%
SHEVPS	378,523	2.78%
PHEV20	46,393	0.34%
PHEV20T	18,943	0.14%
PHEV50	2,392	0.02%
PHEV50T	18	0.0001%
BEV200	72,123	0.53%
BEV300	145,900	1.07%
BEV400	34,000	0.25%
BEV500	0	0%
FCV	744	0.005%

BILLING CODE 4910-59-C

Micro and mild hybrids refer to the presence of SS12V and BISG, respectively. The data sources discussed above are used to identify the presence of these technologies on vehicles in the fleet. Vehicles are assigned one of these technologies only if its presence can be confirmed with manufacturer brochures or technical specifications.

Strong hybrid technologies include SHEVPS and SHEVP2. Note that P2HCR0, P2HCR1, P2HCR1D, and P2HCR2 are not assigned in the fleet and are only available to be applied by the model. When possible, manufacturer specifications are used to identify the strong hybrid architecture type. In the absence of more sophisticated information, hybrid architecture is determined by number of motors. Hybrids with one electric motor are assigned P2, and those with two motors are assigned PS. We sought comment in the NPRM on additional ways the agency could perform initial hybrid assignments based on publicly available information or technical publications. We did not receive any substantive comments regarding baseline fleet strong hybrid assignments. Accordingly, this final rule analysis uses the same approach to assigning SHEVPS and SHEVP2 in the baseline fleet.

Plug-in hybrid technologies PHEV20/20T and PHEV50/50T are assigned in the baseline fleet. PHEV20H and PHEV50H are not assigned in the fleet and are only available to be applied by the model. Vehicles with an electric-

only range of 40 miles or less are assigned PHEV20; vehicles with a range above 40 miles are assigned PHEV50.

They are respectively assigned PHEV20T/50T if the engine is turbocharged (*i.e.*, if it would qualify for one of technologies on the turbo engine technology pathway). We also calculate baseline fuel economy values for PHEV technologies as part of the PHEV analysis fleet assignments; that process is described in detail in TSD Chapter 3.3.2.

Battery electric vehicle and fuel cell technologies include BEV200/300/400/500 and FCEV with a 320-mile range. The BEV technologies are assigned to vehicles based on range thresholds that best account for vehicles' existing range capabilities while allowing room for the model to potentially apply more advanced electrification technologies. Vehicles with all-electric powertrains that use hydrogen fuel are assigned FCEV.

For more detail about the electrification analysis fleet assignment process, see TSD Chapter 3.3.2.

(c) Electrification Adoption Features

Multiple types of adoption features apply to the electrification technologies. The hybrid/electric technology path logic dictates how different vehicle types can adopt different levels of electrification technology. Broadly speaking, more advanced levels of hybridization or electrification supersede all prior levels, with certain

technologies within each level being mutually exclusive.

As discussed further below, SKIP logic—restrictions on the adoption of certain technologies—apply to plug-in (PHEV) and strong hybrid vehicles (SHEV). Some technologies on these pathways are “skipped” if a vehicle is high performance, requires high towing capabilities as a pickup truck, or belongs to certain manufacturers who have demonstrated that their future product plans will more than likely not include the technology. The specific criteria for SKIP logic for each applicable electrification technology is expanded on later in this section.

This section also discusses the supersession of engines and transmissions on vehicles that adopt SHEV or PHEV powertrains. To manage the complexity of the analysis, these types of hybrid powertrains are modeled with several specific engines and transmissions, rather than in multiple configurations. Therefore, the cost and effectiveness values SHEV and PHEV technologies consider these specific engines and transmissions.

Finally, phase-in caps limit the adoption rates of battery electric (BEV) and fuel cell electric vehicles (FCEV). We set the phase-in caps to account for current market share, scalability, and reasonable consumer adoption rates of each technology. TSD Chapter 3.3.3 discusses the electrification phase-in caps and the reasoning behind them in detail.

The only adoption feature applicable to micro and mild hybrid technologies is path logic. The pathway consists of a linear progression starting with a conventional powertrain with no electrification at all, which is superseded by SS12V, which in turn is superseded by BISG. Vehicles can only adopt micro and mild hybrid technology if the vehicle does not already have a more advanced level of electrification.

The adoption features that apply to strong hybrid technologies include path logic, powertrain substitution, and vehicle class restrictions. Per the defined technology pathways, SHEVPS, SHEVP2, and the P2HCR technologies are considered mutually exclusive. In other words, when the model applies one of these technologies, the others are immediately disabled from future application. However, all vehicles on the strong hybrid pathways can still advance to one or more of the plug-in hybrid technologies.

When the model applies any strong hybrid technology to a vehicle, the transmission technology on the vehicle is superseded. Regardless of the transmission originally present, P2 hybrids adopt an 8-speed automatic transmission (AT8L2), and PS hybrids adopt an electronic continuously variable transmission (eCVT).

When the model applies SHEVP2 technology, the model can consider various engine options to pair with the SHEVP2 architecture according to existing engine path constraints, considering relative cost effectiveness. For SHEVPS technology, the existing engine is replaced with Eng26, which is a full Atkinson cycle engine.

SKIP logic is also used to constrain adoption for SHEVPS, P2HCR0, P2HCR1, and P2HCR1D. These technologies are “skipped” for vehicles with engines³²⁹ that met one of the following conditions:

³²⁹ This refers to the engine assigned to the vehicle in the 2020 baseline fleet.

The engine belongs to an excluded manufacturer;³³⁰

The engine belongs to a pickup truck (*i.e.*, the engine is on a vehicle assigned the “pickup” body style);

The engine’s peak horsepower is more than 405 HP; or if

The engine is on a non-pickup vehicle but is shared with a pickup.

No SKIP logic is applied to SHEVP2, however P2HCR2 is not used in this analysis, as discussed further in Section III.D.1.

The reasons for these conditions are similar to those applied to HCR engine technologies, discussed in more detail above. In the real world, pickups and performance vehicles with certain powertrain configurations cannot adopt the technologies listed above and maintain vehicle performance without redesigning the entire powertrain. SKIP logic is put in place to prevent the model from pursuing compliance pathways that are ultimately unrealistic.

Auto Innovators in their comments for the NPRM, also to the 2018 NPRM, discussed issues with HCR technologies.³³¹ Ford had similarly provided comments in opposition of high dependency on HCR technologies.³³² For further discussion of HCR, see Section III.D.1.c).

PHEV technologies supersede the micro, mild, and strong hybrids, and can only be replaced by full electric technologies. Plug-in hybrid technology paths are also mutually exclusive, with the PHEV20 technologies able to progress to the PHEV50 technologies.

The engine and transmission technologies on a vehicle are superseded when PHEV technologies are applied to a vehicle. For all plug-in technologies, the model applies an AT8L2 transmission. For PHEV20/50 and PHEV20H/50H, the vehicle receives

³³⁰ Excluded manufacturers included BMW, Daimler, and Jaguar Land Rover.

³³¹ Auto Innovators, Docket No. NHTSA–2018–0067–12073–A1, at p. 139.

³³² Ford, Docket No. NHTSA–2018–0067–11928–A1, at p. 8.

a full Atkinson cycle engine, Eng26, and for PHEV20T/50T, the vehicle receives a TURBO1 engine, Eng12.

SKIP logic applies to PHEV20/20H and PHEV50/50H under the same four conditions listed for the strong hybrid technologies in the previous section, for the same reasons previously discussed.

The adoption of BEVs and FCEVs is limited by both path logic and phase in caps. BEV200/300/400/500 and FCEV are applied as end-of-path technologies that superseded previous levels of electrification.

The main adoption feature applicable to BEVs and FCEVs is phase-in caps, which are defined in the CAFE Model input files as percentages that represent the maximum rate of increase in penetration rate for a given technology. They are accompanied by a phase-in start year, which determines the first year the phase-in cap applies. Together, the phase-in cap and start year determine the maximum penetration rate for a given technology in a given year; the maximum penetration rate equals the phase-in cap times the number of years elapsed since the phase-in start year. Note that phase-in caps *do not* inherently dictate how much a technology is applied by the model. Rather, they represent how much of the fleet *could* have a given technology by a given year. Because BEV200 costs less and has higher effectiveness values than other advanced electrification technologies,³³³ the model will have vehicles adopt it first, until it is restricted by the phase-in cap.

Table III–18 shows the phase-in caps, phase-in year, and maximum penetration rate through 2050 for BEV and FCEV technologies. For comparison, the actual penetration rate of each technology in the baseline fleet is also listed in the fourth column from the left.

³³³ This is because BEV200 uses fewer batteries and weighs less than BEVs with greater ranges.

Table III-18 – Phase-In Caps for Fuel Cell and Battery Electric Vehicle Technologies

Technology Name	Phase-In Cap	Phase-In Start Year	Actual Penetration Rate in 2020 (Baseline Fleet)	Maximum Penetration Rate in 2020	Maximum Penetration Rate in 2025	Maximum Penetration Rate in 2030	Maximum Penetration Rate in 2035	Maximum Penetration Rate in 2040	Maximum Penetration Rate in 2045	Maximum Penetration Rate in 2050
BEV200	0.09%	1998	0.53%	1.98%	2.43%	2.88%	3.33%	3.78%	4.23%	4.68%
BEV300	0.70%	2009	1.07%	7.70%	11.20%	14.70%	18.20%	21.70%	25.20%	28.70%
BEV400	1.25%	2016	0.25%	5.00%	11.25%	17.50%	23.75%	30.00%	36.25%	42.50%
BEV500	4.25%	2021	-	-	17.00%	38.25%	59.50%	80.75%	102.00%	123.25%
FCEV	0.018%	2016	0.005%	0.072%	0.162%	0.252%	0.342%	0.432%	0.522%	0.612%

The BEV200 phase-in cap is informed by manufacturers' tendency to move away from low-range vehicle offerings, in part because of consumer hesitancy to adopt this technology. The advertised range on most electric vehicles does not reflect extreme cold and hot real-world driving conditions that affect the utility of already low-range vehicles.³³⁴ Many manufacturers have told us that the portion of consumers willing to accept a vehicle with our lowest range model which is less than 250 miles of electric range is small, and many manufacturers do not plan to offer vehicles with less than 250 miles of electric range.³³⁵

Furthermore, the average BEV range has steadily increased over the past decade,³³⁶ perhaps in part as batteries have become more cost effective. EPA observed in its 2021 Automotive Trends Report that "the average range of new EVs has climbed substantially. In model year 2020 the average new EV is projected to have a 286-mile range, or about four times the range of an average EV in 2011. This difference is largely attributable to higher production of new EVs with much longer ranges."³³⁷ The maximum growth rate for BEV200 in the model is set accordingly low to less than 0.1 percent per year. While this rate is

significantly lower than that of the other BEV technologies, the BEV200 phase-in cap allows the penetration rate of low-range BEVs to grow by a multiple of what is currently observed in the market.

For BEV300, 400, and 500, phase-in caps are intended to conservatively reflect potential challenges in the scalability of BEV manufacturing, and implementing BEV technology on many vehicle configurations, including larger vehicles. In the short term, the penetration of BEVs is largely limited by battery availability. For example, Tesla is not yet producing electric vans because of cell production constraints, and it remains a bottleneck in the company's expansion into new product lines.³³⁸ Incorporating battery packs that provide greater amounts of electric range into vehicles also poses its own engineering challenges. Heavy batteries and large packs may be difficult to integrate for many vehicle configurations, and require structural vehicle modifications. Pickup trucks and large SUVs, in particular, require higher levels of energy as the number of passengers and/or payload increases, for towing and other high-torque applications. The BEV400 and 500 phase-in caps reflect these transitional challenges.

The phase-in cap for FCEVs is based on existing market share as well as historical trends in FCEV production. FCEV production share in the past five years has been extremely low, and we

set the phase-in cap accordingly.³³⁹ As with BEV200, however, the phase-in cap still allows for the market share of FCEVs to grow several times over.

We received limited comments on the NPRM referring to how we apply electrification adoption features for the analysis. In its comments to EPA's NPRM, submitted to our docket as a courtesy, Auto Innovators stated they expect that consumers are likely to be more accepting of longer BEV ranges,³⁴⁰ which generally agrees with our expectations and reasoning in support of why we set the BEV200 phase-in cap.

In contrast, ICCT stated that "there is no engineering or technical reason to limit application of strong hybrids in the fleet. Powersplit hybrids may have torque limits, but there is no limitation for parallel hybrid systems, whether P0, P1, P2, P3, or P4 architecture, as the engine output is routed separately from the motor output. This is demonstrated by the 2021 Ford F150 pickup truck with a P2 strong hybrid and the upcoming 2022 Toyota Tundra full-size pickup truck with a strong hybrid and a conventional 10-speed automatic."³⁴¹ ICCT also included examples of hybrid applications in support of its comment that all vehicles can benefit from hybrid technology that included the Porsche 918 plug-in hybrid, 2019 Dodge Ram 1500 pickup truck, and 2021 Ford F150 pickup truck. Similarly, Tesla stated that we artificially constrained the level of electrification, pointing to the phase-in caps placed on BEVs.

³³⁴ AAA. "AAA Electric Vehicle Range Testing." February 2019. <https://www.aaa.com/AAA/common/AAR/files/AAA-Electric-Vehicle-Range-Testing-Report.pdf> (accessed: Feb. 11, 2022).

³³⁵ See also, e.g., Baldwin, Roberto. "Tesla Model Y Standard Range Discontinued; CEO Musk Tweets Explanation." Car and Driver, 30 Apr. 2021, www.caranddriver.com/news/a35602581/elon-musk-model-y-discontinued-explanation. (Accessed: May 20, 2020)

³³⁶ 2021 EPA Automotive Trends Report, at 56, figure 4.17.

³³⁷ 2021 EPA Automotive Trends Report, at p. 58.

³³⁸ Hyatt, Kyle. "Tesla Will Build an Electric Van Eventually, Elon Musk Says." Roadshow, CNET, 28 Jan. 2021, www.cnet.com/roadshow/news/tesla-electric-van-elon-musk/. (Accessed May 20, 2021)

³³⁹ 2020 EPA Automotive Trends Report, at 52, figure 4.13.

³⁴⁰ Auto Innovators, at p. 56.

³⁴¹ ICCT, at p. 10.

Regarding ICCT's comment, the NPRM analysis only limited adoption of SHEVPS and P2HCR combinations for a small number of applications like pickups, large SUVs that shared pickup engines, and performance-oriented vehicles. All other conventional vehicles can adopt P2 hybrid powertrains; for example, the Toyota Tundra, which has a turbocharged engine paired with a 10-speed automatic transmission is allowed to adopt P2 hybrid. Additionally, most vehicles can adopt a PS hybrid system, like the Toyota Highlander. ICCT's other example, the Porsche 918, an \$845,000 4.6 liter V8 plug-in P2 hybrid with total 887 hp and 944 lb.-ft of torque, is an example of a vehicle that we could model in our analysis as a SHEVP2 plug-in hybrid.³⁴² However, it is unclear to what extent the hybrid technology on the Porsche 918 could apply to the mass market fleet. Other U.S. market Porsche plug-in hybrids, like the Cayenne E-Hybrid and Panamera E-Hybrid, are modeled as SHEVP2 plug-hybrids in our analysis.³⁴³ In all cases, the examples provided by ICCT were modeled in accordance with their comments.^{344 345}

For both the NPRM and the final rule analysis, BEVs have phase-in cap limitations applied based on an analysis market availability, battery costs, and consumer acceptance in the rule making time frame.³⁴⁶ The BEV200 is limited to a greater extent than the BEV300 and BEV400 to account for anticipated market demand for shorter-range BEVs. As discussed earlier, the 2021 EPA Trends Report that showed that the average range of BEVs has increased beyond 200 miles to an average of 286 miles. As such, 300-mile range BEVs

and up will most likely become the status quo for the fleet in the rulemaking time frame.³⁴⁷ In addition, the BEV300 and BEV400 caps were not met in either the NPRM or this final rule analysis for any of the alternatives considered. This means that even with the market caps in place, the alternatives did not require manufacturers to increase BEV production because the standards were met with other cost-effective technologies. Accordingly, for the final rule analysis, we continued to use the same adoption features as used in the NPRM to reflect what we believe will foreseeably occur in the market in the rulemaking time frame.

(d) Electrification Effectiveness Modeling

For this analysis, we consider a range of electrification technologies which, when modeled, result in varying levels of effectiveness at reducing fuel consumption. As discussed above, the modeled electrification technologies include micro hybrids, mild hybrids, two different strong hybrids, two different plug-in hybrids with two separate all electric ranges, full battery electric vehicles, and fuel cell electric vehicles. Each electrification technology consists of many complex sub-systems with unique component characteristics and operational modes. As discussed further below, the systems that contribute to the effectiveness of an electrified powertrain in the analysis include the vehicle's battery, electric motors, power electronics, and accessory loads. Procedures for modeling each of these sub-systems are broadly discussed in this section and the Autonomie model documentation.

Argonne uses data from their Advanced Mobility Technology Laboratory (AMTL) to develop Autonomie's electrified powertrain models. The modeled powertrains are not intended to represent any specific manufacturer's architecture but are intended to act as surrogates predicting representative levels of effectiveness for each electrification technology.

Autonomie determines the effectiveness of each electrified powertrain type by modeling the basic components, or building blocks, for each powertrain, and then combining the components modularly to determine the overall efficiency of the entire powertrain. Autonomie identifies components for each electrified powertrain type, and then interlinks those components to create a powertrain architecture. Autonomie then models

each electrified powertrain architecture and provides an effectiveness value for each. For example, Autonomie determines a BEV's overall efficiency by considering the efficiencies of the battery, the electric traction drive system (the electric machine and power electronics), and mechanical power transmission devices. Or, for a SHEVP2, Autonomie combines a very similar set of components to model the electric portion of the hybrid powertrain, and then also includes the combustion engine and related power for transmission components. See TSD Chapter 3.3.4 and the Autonomie model documentation for a complete discussion of electrification component modeling.

As discussed earlier in Section III.C.4, Autonomie applies different powertrain sizing algorithms depending on the type of vehicle considered because different types of vehicles not only contain different powertrain components to be optimized, but they must also operate in different driving modes. While the conventional powertrain sizing algorithm must consider only the power of the engine, the more complex algorithm for electrified powertrains must simultaneously consider multiple factors, which could include the engine power, electric machine power, battery power, and battery capacity. Also, while the resizing algorithm for all vehicles must satisfy the same performance criteria, the algorithm for some electric powertrains must also allow those electrified vehicles to operate in certain driving cycles, like the US06 cycle, without assistance of the combustion engine, and ensure the electric motor/generator and battery can handle the vehicle's regenerative braking power, all-electric mode operation, and intended range of travel.

To establish the effectiveness of the technology packages, Autonomie simulates the vehicles' performance on compliance test cycles, as discussed in Section III.C.4.^{348 349 350} The range of effectiveness for the electrification technologies in this analysis is a result of the interactions between the components listed above and how the modeled vehicle operates on its respective test cycle.

³⁴⁸ See U.S. EPA, "How Vehicles are Tested." https://www.fueleconomy.gov/feg/how_tested.shtml. (Accessed: May 6, 2021)

³⁴⁹ See Autonomie model documentation, Chapter 6, Test Procedures and Energy Consumption Calculations.

³⁵⁰ EPA Guidance Letter. "EPA Test Procedures for Electric Vehicles and Plug-in Hybrids." Nov. 14, 2017. <https://www.fueleconomy.gov/feg/pdfs/EPA%20test%20procedure%20for%20EVs-PHEVs-11-14-2017.pdf>. (Accessed: May 6, 2021)

³⁴² Porsche. "The Super Sportscar." <https://newsroom.porsche.com/en/products/918-spyder-10713.html>. (Accessed: Dec. 17, 2021); Cnet Road and Show. "Porsche 918 Spyder: Plug-in hybrid does 94mpg, 198mph." <https://www.cnet.com/roadshow/pictures/porsche-918-spyder-plug-in-hybrid-does-94mpg-198mph/>. (Accessed: Dec. 17, 2021)

³⁴³ See the market_data file vehicle codes 4212003, 4212004, 4212009, 4212010, 4222003, 4222004, 4222005, 4222015, 4222016, and 4222017 in the vehicles tab.

³⁴⁴ 2022 Toyota Tundra Product Information. 2022_Toyota_Tundra_Product_Information_FINAL.pdf; Buchholz, K., "2022 Toyota Tundra: V8 out, twin-turbo hybrid takes over", SAE, September 22, 2021. <https://www.sae.org/news/2021/09/2022-toyota-tundra-gains-twin-turbo-hybrid-power>. (Accessed: Dec. 20, 2021); Macaulay, S., "Engineering the 2022 Toyota Tundra", SAE, October 10, 2021. <https://www.sae.org/news/2021/10/engineering-the-2022-toyota-tundra>. (Accessed: Dec. 20, 2021)

³⁴⁵ ICCT, at p. 8.

³⁴⁶ John Elkin, MIT finds that it might take a long time for EVs to be as affordable as you want, Digital Trends (November 23, 2019), <https://www.digitaltrends.com/cars/mit-study-finds-ev-market-will-stall-in-the-2020s/>.

³⁴⁷ 20210 EPA Automotive Trends Report, at 536, figure 4.174.

This range of values will result in some modeled effectiveness values being close to real-world measured values, and some modeled values that will depart from real-world measured values, depending on the level of similarity between the modeled hardware configuration and the real-world hardware and software configurations. This modeling approach comports with NAS's 2015 recommendation to use full vehicle modeling supported by application of lumped improvements at the sub-model level.³⁵¹ In addition, the more recent 2021 NAS Report modeled electrification technologies with Argonne's Autonomie model using a similar approach to our analysis.³⁵²

We received limited comments regarding electrification effectiveness modeling. ICCT commented that the agency's strong hybrid effectiveness data are outdated, because we rely on older powertrain data like engine maps from the 2010 Toyota Prius, and we do not allow this engine and other hybrid technologies to improve.³⁵³ Similarly, ICCT recommended that further research should be considered to improve hybrid power management and engines for strong hybrids.³⁵⁴ Another commenter, Walter Kreucher, stated that the electric ranges for electrified vehicles are lower than what we are

modeling. Specifically, Mr. Kreucher stated that extreme cold, hot, and aggressive driving conditions have reduced all-electric range anywhere from 39 to 51 percent, based on a study from AAA.³⁵⁵

We disagree with ICCT that the electrification technology represented in this analysis is outdated. The majority of the technologies were developed specifically to support analysis for this rulemaking time frame. For example, the hybrid Atkinson engine peak thermal efficiency was updated based on 2017 Toyota Prius engine data.³⁵⁶ Toyota stated that their current hybrid engines achieve 41 percent thermal efficiency for their current product line up which aligns with our modeling.³⁵⁸ Similarly, the electric machine peak efficiency for FCEVs and BEVs is 98 percent and based on the 2016 Chevy Bolt.³⁵⁹ Accordingly, we have made no

³⁵⁵ Walt Kreucher, Docket No. NHTSA-2021-0053-0015, at p. 6.

³⁵⁶ Atkinson Engine Peak Efficiency is based on 2017 Prius Peak Efficiency and scaled up to 41 percent. Autonomie Model Documentation at p. 138.

³⁵⁷ Docketed supporting material. ANL—All Assumptions_Summary_NPRM_022021.xlsx, ANL—Summary of Main Component Performance Assumptions_NPRM_022021.xlsx, Argonne Autonomie Model Documentation_NPRM.pdf and ANL—Data Dictionary_NPRM_022021.XLSX.

³⁵⁸ Carney, D. "Toyota unveils more new gasoline ICEs with 40% thermal efficiency". SAE. April 4, 2018. <https://www.sae.org/news/2018/04/toyota-unveils-more-new-gasoline-ices-with-40-thermal-efficiency>. (Accessed Dec. 21, 2021)

³⁵⁹ F. Momen, K. Rahman, Y. Son and P. Savagian, "Electrical propulsion system design of

changes to the electric machine efficiency maps for this final rule analysis.

We agree with Mr. Kreucher that extreme cold and hot conditions impact electrified vehicle range. We use the latest compliance testing procedures to appropriately evaluate the effectiveness and range of electrified technologies, as discussed earlier in this section. However, there are some extreme conditions, which may impact electric vehicle range, which may not be captured by the Federal test cycle. The selection of a phase-in cap for BEV200 is based in part on consideration of differences in utility, including the potential for temperature-based (among other things) variations in driving range, that may affect consumer adoption of shorter-range BEVs. For more details, see Section III.D.3.c) of this preamble, Electrification Adoption Features.

The range of effectiveness values for the electrification technologies, for all ten vehicle technology classes, is shown in Figure III-13. In the graph, the box shows the inner quartile range (IQR) of the effectiveness values and whiskers extend out 1.5 x IQR. The dots outside of the whiskers show values outside these bounds.

BILLING CODE 4910-59-P

Chevrolet Bolt battery electric vehicle," 2016 IEEE Energy Conversion Congress and Exposition (ECCE), 2016, pp. 1-8, doi: 10.1109/ECCE.2016.7855076.

³⁵¹ 2015 NAS Report, at p. 292.

³⁵² 2021 NAS Report, at p. 189.

³⁵³ ICCT, at p. 5.

³⁵⁴ ICCT, in Appendices at p. 2.

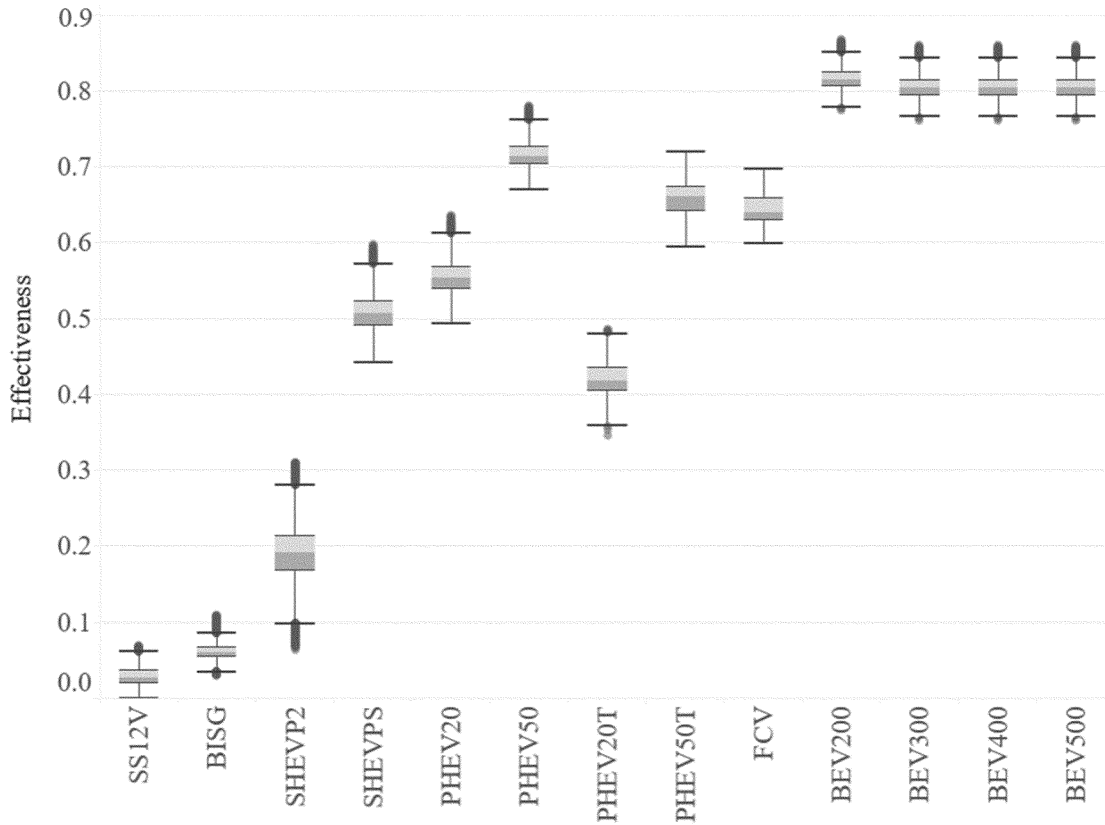

Figure III-13 – Electrification Technology Effectiveness Values for All Vehicle Technology Classes³⁶⁰

BILLING CODE 4910-59-C

(e) Electrification Costs

The total cost to electrify a vehicle in this analysis is based on the battery the vehicle requires, the non-battery electrification component costs the vehicle requires, and the traditional powertrain components that must be added or removed from the vehicle to build the electrified powertrain.

We work collaboratively with the experts at Argonne National Laboratory to generate battery costs using BatPaC, which is a model designed to calculate the cost of a vehicle battery for a specified battery power, energy, and type. For this analysis, Argonne used BatPaC v4.0 (October 2020 release) to create lookup tables for battery cost and mass that the Autonomie simulations reference when a vehicle receives an electrified powertrain. The BatPaC battery cost estimates for mild hybrids, strong hybrids, plug-in hybrids, and full battery electric vehicles are generated for a base year, in this case for MY 2020. Accordingly, our BatPaC inputs characterize the state of the market in

MY 2020 and employ a widely utilized cell chemistry (NMC622),³⁶¹ average estimated battery pack production volume per plant (25,000), and a plant efficiency or plant cell yield value of 95 percent.

For this final rule, we use a lower SS12V micro hybrid battery cost that was not developed in BatPaC. The NPRM SS12V fixed battery pack direct manufacturing cost was \$237, across all vehicle classes. For this final rule analysis, the agency conducted additional research regarding battery types used in typical SS12V systems yielding a battery cost that reflects the

cost of a more common battery chemistry. Specifically, absorbed-glass-mat (AGM) batteries are more common in SS12V systems than the Li-ion-based chemistry used in the NPRM analysis.^{362 363 364} The battery pack direct manufacturing cost for SS12V systems is now \$113, across all vehicle classes. This cost also more closely aligns with the estimated cost of the SS12V system presented in the 2015 NAS Report.³⁶⁵

For BEV400 and BEV500, we did not use BatPaC to generate battery pack costs. Rather, we scaled the BatPaC-generated BEV300 costs to match the range of BEV400 and BEV500 vehicles to compute a direct manufacturing cost for those vehicles' batteries. We explained in the NPRM that we initially examined using BatPaC to model the

³⁶¹ Autonomie model documentation, Chapter 5.9. Argonne surveyed A2Mac1 and TBS teardown reports for electrified vehicle batteries and of the five fully electrified vehicles surveyed, four of those vehicles used NMC622 and one used NMC532. See also Georg Bieker, A Global Comparison of the Life-Cycle Greenhouse Gas Emissions of Combustion Engine and Electric Passenger Cars, International Council on Clean Transportation (July 2021), https://theicct.org/sites/default/files/publications/Global-LCA-passenger-cars-jul2021_0.pdf ("For cars registered in 2021, the GHG emission factors of the battery production are based on the most common battery chemistry, NMC622-graphite batteries"); 2021 NAS Report, at 87 (" . . . NMC622 is the most common cathode chemistry in 2019. . . .").

³⁶² EPA-HQ-OAR-2021-0208-0144, p. 5-73.

³⁶³ USABC, "United States Advanced Battery Consortium Battery Test Manual For 12 Volt Start/Stop Vehicles." January 2018. Revision 2. Contract DE-AC07-05ID14517.

³⁶⁴ H. Tataria; O. Gross; C. Bae; B. Cunningham; J.A. Barnes; J. Deppe; J. Neubauer. "USABC Development of 12 Volt Battery for Start-Stop Application: Preprint": 10 pp. 2015. <https://www.nrel.gov/docs/fy15osti/62680.pdf>.

³⁶⁵ 2015 NAS Report, at 158.

³⁶⁰ The data used to create this figure can be found in the FE_1 Adjustments file.

cost and weight of BEV400 and BEV500 packs, however, initial values from the model could not be validated and were based on assumptions for smaller sized battery packs. We stated that the initial results provided cost and weight estimates for BEV400 battery packs out of alignment with current examples of BEV400s in the market, and there are currently no examples of BEV500 battery packs in the market against which to validate the pack results.

Although one example of a BEV500 has entered the market since publication of the NPRM, it is for a low volume passenger vehicle, and it is not representative of some pack characteristics and costs for vehicles in this analysis.^{366 367} In particular, BatPaC weights for the BEV400 and BEV500 pickup truck classes often made the vehicle exceed the light duty 8,500 lb. curb weight threshold for light duty vehicles, pushing the vehicles into the next weight class. While this may be representative of what could happen with vehicles that have more significant range and towing requirements (for example, the 2022 GMC Hummer EV will be a class 2b vehicle³⁶⁸), we also believe that manufacturers will employ different weight saving strategies to keep heavier vehicles in the light-duty fleet. For this final rule analysis, we determined that keeping the battery pack mass a more consistent percentage of vehicle curb weight using the scaling method was a reasonable assumption, and we will explore how to model this concept more in future analyses.

Finally, we apply a learning rate to the direct manufacturing cost to reflect how we expect battery costs could fall over the timeframe considered in the analysis. For most electrification technologies, the learning rate that we apply reflects “midrange” year-over-year improvements until MY 2032. Post 2032, the learning rates incrementally become shallower as battery technology is expected to mature in MY 2033 and beyond. Applying learning curves to the battery pack DMC in subsequent analysis years reduces costs such that battery pack costs are believed to

represent the manufacturing costs for any future pack, regardless of cell chemistry, cell format, or production volume.

Unlike the rest of the electrification technologies, however, the SS12V micro hybrid system uses a shallower learning curve, as shown in TSD Chapter 3.3.5.2. This shallow curve reflects the maturity of the technology; as we discuss in TSD Chapter 3.3.2, 50 percent of the MY 2020 fleet utilizes a SS12V micro hybrid system.

TSD Chapter 3.3.5.1 includes more detail about the process to develop battery costs for this analysis. In addition, all BatPaC-generated direct manufacturing costs for all technology keys can be found in the CAFE Model’s Battery Costs file, and the Argonne BatPaC Assumptions file includes the assumptions used to generate the costs, pack costs, pack mass, cell capacity, \$/kW at the pack level, and W/kg at the pack level for all vehicle classes.

A range of parameters can ultimately influence battery pack manufacturing costs, including other vehicle improvements (e.g., mass reduction technology, aerodynamic improvements, or tire rolling resistance improvements all affect the size and energy of a battery required to propel a vehicle where all else is equal), and the availability of materials required to manufacture the battery.^{369 370} Or, if manufacturers adopt more electrification technology than projected in this analysis, increases in battery pack production volume will likely lower actual battery pack costs.

In the NPRM, we compared our battery pack costs in future years to battery pack costs from a non-exhaustive list of other sources that may or may not account for some of these additional parameters, including varying potential future battery chemistry and learning rates. As discussed in TSD Chapter 3.3.5.1.4, our battery pack costs in 2025 and 2030 fell fairly well in the middle of other sources’ cost projections, with Bloomberg New Energy Finance (BNEF)

projections presenting the highest year-over-year cost reductions, and one scenario in MIT’s Insights into Future Mobility report providing an upper bound of potential future costs of the studies surveyed to create this comparison.^{371 372} ICCT presented a similar comparison of costs from several sources in its 2019 working paper and predicted battery pack costs in 2025 and 2030 would drop to approximately \$104/kWh and \$72/kWh, respectively, which put their projections slightly higher than BNEF’s 2019 projections.³⁷³ BNEF’s 2020 Electric Vehicle Outlook projected average pack cost to fall below \$100/kWh by 2024, while the 2021 NAS Report projected pack costs to reach \$90–115/kWh by 2025.^{374 375} Since the NPRM, BNEF released its 2021 Electric Vehicle Outlook, which estimated average pack prices in 2021 at \$132/kWh.³⁷⁶ In addition, Bloomberg weighed in on recent supply chain impacts on battery materials availability, which is discussed in more detail below.

We concluded in the NPRM that our projected costs seemed to fall between several projections, giving confidence that the costs used in the analysis could reasonably represent future battery pack costs across the industry during the rulemaking time frame. We emphasized that battery technology is currently under intensive development, and that characteristics such as cost, and capability are rapidly changing. These advances are reflected in recent aggressive projections, like those from ICCT, BNEF, and the 2021 NAS Report.

We sought comment on several elements of the battery modeling analysis in the NPRM, including on battery direct manufacturing costs, or DMCs (and inputs and assumptions

³⁷¹ See Logan Goldie-Scot, A Behind the Scenes Take on Lithium-ion Battery Prices, Bloomberg New Energy Finance (March 5, 2019), <https://about.bnef.com/blog/behind-scenes-take-lithium-ion-battery-prices/>.

³⁷² MIT Energy Initiative. 2019. Insights into Future Mobility. Cambridge, MA: MIT Energy Initiative. Available at <http://energy.mit.edu/insightsintofuturemobility>.

³⁷³ Nic Lutsey and Michael Nicholas, “Update on electric vehicle costs in the United States through 2030”, ICCT (April 2, 2019), available at <https://theicct.org/publications/update-US-2030-electric-vehicle-cost>.

³⁷⁴ Bloomberg New Energy Finance (BNEF), “Electric Vehicle Outlook 2020,” <https://about.bnef.com/electric-vehicle-outlook/>, last accessed July 29, 2021.

³⁷⁵ 2021 NAS Report, at 114. The 2021 NAS Report assumed a 7 percent cost reduction per year from 2018 through 2030.

³⁷⁶ BloombergNEF, “Battery Pack Prices Fall to an Average of \$132/kWh, But Rising Commodity Prices Start to Bite,” November 30, 2021. https://about.bnef.com/blog/battery-pack-prices-fall-to-an-average-of-132-kwh-but-rising-commodity-prices-start-to-bite/#_ftn1. (Last accessed: January 10, 2022)

³⁶⁶ CarAndDriver. “2022 Lucid Air Lucid Air EV’s Battery Will Be a Big 113.0 kWh, Topping Tesla’s Best.” September 2, 2020. <https://www.caranddriver.com/news/a33797162/2021-lucid-air-517-mile-range-113-kwh-battery>. Last accessed March 28, 2022.

³⁶⁷ Fueleconomy.gov, 2022 Lucid Air. <https://www.fueleconomy.gov/feg/Find.do?action=sbs&id=44495&id=44493> (last accessed: January 23, 2022).

³⁶⁸ CarAndDriver. “2022 GMC Hummer EV EPA Documents Reveal MPGe, Weight, Other Details.” Feb 15, 2022. <https://www.caranddriver.com/news/a39049358/2022-gmc-hummer-ev-pickup-epa-specs>. Last accessed March 28, 2022.

³⁶⁹ The cost of raw material also has a meaningful influence on the future cost of the battery pack. As the production volume goes up, the demand for battery critical raw materials also goes up, which has an offsetting impact on the efficiency gains achieved through economies of scale, improved plant efficiency, and advanced battery cell chemistries, at least while supply is readjusting to demand. We do not consider future battery raw material price fluctuations for this analysis, however that may be an area for further exploration in future analyses.

³⁷⁰ See, e.g., Jacky Wong, EV Batteries: The Next Victim of High Commodity Prices?, The Wall Street Journal (July 22, 2021), <https://www.wsj.com/articles/ev-batteries-the-next-victim-of-high-commodity-prices-11626950276>.

used in BatPaC to estimate those costs), battery learning curves, and other battery-related materials. More specifically, we first sought comments on DMC assumptions, including comments supported by data elements on different assumptions for battery chemistry, plant manufacturing volume, or plant efficiency in MY 2020.³⁷⁷ To align with our guiding principle that each technology model employed in the analysis be representative of a wide range of specific technology applications used in the industry, we requested that commenters explain how these assumptions reasonably represent applications across the industry in MY 2020.³⁷⁸ This is important to ensure that the CAFE Model's simulation of manufacturer compliance pathways results in impacts that we would reasonably expect to see in the real world. In addition, we sought comment on the scaling used to generate direct manufacturing costs for BEV400 and BEV500 technologies; in particular, we were interested in any additional data or information on the relationship between cost and weight for heavier battery packs used for these higher-range BEV applications, particularly in light truck vehicle segments.

We also sought comment on the learning rates applied to battery pack costs and on battery pack costs in future years. We recognized that any battery pack cost projections for future years from our analysis or external analyses will involve assumptions that may or may not come to pass and stated that it would be most helpful if commenters

³⁷⁷ Note that stakeholders had commented on the 2020 final rule that batteries using NMC811 chemistry had either recently come into the market or was imminently coming into the market, and therefore DOT should have selected NMC811 as the appropriate chemistry for modeling battery pack costs. Similar to the other technologies considered in this analysis, DOT endeavors to use technology that is a reasonable representation of what the industry could achieve in the model year or years under consideration, in this case the base DMC year of 2020, as discussed above. At the time of this current analysis, the referenced A2Mac1 teardown reports and other reports provided the best available information about the range of battery chemistry actually employed in the industry. At the time of writing for this final rule, DOT still has not found examples of NMC811 in commercial application across the industry in a way that DOT believes selecting NMC811 would have represented industry average performance in MY 2020. As discussed in TSD Chapter 3.3.5.1.4, DOT did analyze the potential future cost of NMC811 in the composite learning curve generated to ensure the battery learning curve projections are reasonable.

³⁷⁸ Again, some vehicle manufacturer's systems may perform better and cost less than our modeled systems and some may perform worse and cost more. However, employing this approach will ensure that, on balance, the analysis captures a reasonable level of costs and benefits that would result from any manufacturer applying the technology.

thoroughly explained the basis for any recommended learning rates, including references to publicly available data or models (and if such models are peer reviewed) where appropriate. We also noted that it would be helpful for commenters to note where external analyses may or may not take into account certain parameters in their battery pack cost projections, and whether we should attempt to incorporate those parameters in our analysis. For example, as discussed above, our analysis does not consider long-term trends in raw material prices; however, the price of raw materials may put a lower bound on NMC-based battery prices.³⁷⁹

We also stated that it would also be helpful if commenters explained how learning rates or future cost projections could represent the state of battery technology across the industry. Like other technologies considered in this analysis, some battery and vehicle manufacturers have more experience manufacturing electric vehicle battery packs, and some have less, meaning that different manufacturers will be at different places along the learning curve in future years. We also stated that comments should specify whether their referenced costs, either for MY 2020 or for future years, are for the battery cell or the battery pack. We requested the information to ensure our learning rates encompass these diverse parameters and to ensure that the analysis best predicts the costs and benefits associated with standards.

Tesla commented that the battery pack costs we projected in the SAFE rule were too high, citing lower estimates published in the UBS-sponsored Volkswagen ID 3 teardown report, among other studies.³⁸⁰ Tesla also commented that we unnecessarily constrained the analysis by assuming that the drivetrain and other components are unique to each vehicle and not shared by another vehicle.³⁸¹

To be clear, the battery pack DMCs used in our 2021 proposal and this final rule are different than the battery pack DMCs used in the SAFE rule that Tesla refers to in their comments. While our

³⁷⁹ See, e.g., MIT Energy Initiative. 2019. *Insights into Future Mobility*. Cambridge, MA: MIT Energy Initiative. Available at <http://energy.mit.edu/insightsintofuturemobility>, at pp. 78–79.

³⁸⁰ Tesla, at p. 9; DNV-GL, Tesla's Battery Day and the Energy Transition (Oct. 26, 2020); BNEF, Electric Vehicle Outlook 2021 (June 9, 2021); BNEF, Hitting the Inflection Point: Electric Vehicle Price Parity and Phasing Out Combustion Vehicle Sales in Europe (May 5, 2021); 2021 NAS Report; UBS, EVs Shifting into Overdrive: VW ID.3 teardown—How will electric cars re-shape the auto industry? (March 2, 2021).

³⁸¹ Tesla, at p. 10.

battery pack DMCs have decreased since the 2020 final rule, our projected costs are still higher than the sources that Tesla identifies. In the NPRM, we provided a detailed explanation of how we developed those costs using the BatPaC model and the specific inputs and assumptions used to do so. We explained that we also expected those costs to represent the range of costs across the industry. We acknowledged that each manufacturer has different strategies associated with each vehicle line based on several factors such as performance, costs, technology class, utility among others, and this affects manufacturers strategy on sourcing only certain components of battery pack or the complete battery pack. We acknowledge that the cost of the battery pack as measured in \$/kWh can vary for each manufacturer with different form, fit, and function requirements.³⁸² BatPaC's inputs and assumptions, including those developed specifically to support this rule,³⁸³ are based on various and extended teardown reports available to the public for predominant batteries that use robust and safe battery chemistries.³⁸⁴ We understand that some mass market and premium luxury BEVs have already achieved \$/kWh values that are lower than our projected costs, however others have not. To investigate the sensitivity of our analysis to this cost we performed additional analyses considering a 20 percent reduction in battery direct manufacturing costs. And as discussed further below, this additional cost reduction had a minimal impact on the overall vehicle cost and increased electrification technology penetration. Therefore, we believe the cost estimates from the BatPaC model represent a reasonable average across all manufacturers for all vehicle technology classes.

In contrast, the Auto Innovators submitted extensive comments on our assumptions that the costs of battery electric vehicles will continue to decline because of decreases in costs to produce battery packs and other non-battery electrification components.³⁸⁵ Auto Innovators stated that “the traditional method of accounting for possible future changes in battery-pack

³⁸² Form, fit, and function is the identification and description of characteristics of a part or assembly. Each defines a specific aspect of the part to help engineers match parts to needs.

³⁸³ See Autonomie Model Documentation.

³⁸⁴ Ahmed, S., Nelson, P., Kubal, J., Liu, Z., Knehr, K. Dees, D., “Estimated cost of EV Batteries.” Argonne. August 12, 2021. <https://www.anl.gov/cse/batpac-model-software>. Last accessed January 20, 2022.

³⁸⁵ Auto Innovators, at pp. 94–121.

costs is to apply a learning curve in future years based on production volume, and then make a somewhat arbitrary assumption about when the rate of decline decelerates or stops (technological maturity).” Auto Innovators identified that we characterized our learning curve as a proxy for changes in battery chemistry, changes in energy density, further gains in plant efficiency, and additional economies of scale in production due to higher production volumes, but stated that we and NAS do not “confront the real possibility that counteracting, unanalyzed factors could work to restrain the future decline in battery-pack costs.”³⁸⁶

Auto Innovators and also the Alliance for Vehicle Efficiency (AVE) requested that we consider potential impacts to battery raw materials costs in the analysis.³⁸⁷ Auto Innovators provided a lengthy qualitative survey of the state of raw materials extraction issues, including their perspective on political and environmental obstacles to further supply development. Auto Innovators also provided estimates of battery materials costs that assumed a doubling of raw materials prices and stated that “a pre-2032 doubling of raw material prices could substantially erode the ‘learning-curve’ cost reductions assumed in the RIAs.” Auto Innovators stated that the battery sensitivity cases presented in the PRIA are not large enough to account for simultaneous increases in several raw materials prices, and that “there is no basis for believing that raw material prices will decline for a sustained period prior to 2032.” Accordingly, Auto Innovators stated that much more careful analysis of raw material prices is necessary in the final RIAs.

With respect to analytical tools available to perform such an analysis, Auto Innovators stated that “less than a handful of the dozens of published battery-forecasting models include any formal analysis of global trends in raw material prices” and stated that “none of the published battery-forecasting models have accounted for the surge in material price experienced in 2021.”³⁸⁸ Auto Innovators stated that “BatPaC does not include a formal global model of the market for each raw material used in battery packs,” and instead provides a best estimate of raw materials prices at the time of version release.³⁸⁹ Auto Innovators stated that the version of BatPaC we used did not account for the

2021 surge in raw material prices. Auto Innovators stated that the MIT’s Insights into Future Mobility report took an important step to forecasting battery pack costs by using a two-stage model, one for the cost of materials and the second for the costs to manufacture the battery pack.³⁹⁰ However, Auto Innovators stated that we erroneously characterized MIT’s estimate as an “upper bound” of battery pack costs, while the report actually provides best estimates based on different scenarios.

Auto Innovators made three explicit requests in regards to future battery materials costs and chemistry impacts; first, Auto Innovators stated that we should work with National Laboratories, DOE, and others to produce sensitivity cases for raw and processed material costs, material efficiency in battery construction, and other considerations; next, Auto Innovators stated that we should remove changes in battery chemistry from the near-term learning factor and analyze it separately and explicitly in our RIA; and finally, Auto Innovators stated that “instead of choosing one battery chemistry as representative of the entire industry, as the [a]gencies do with the Argonne battery model, the [a]gencies should forecast the penetration of different battery chemistries in the fleet from 2021 to 2032 and estimate applicable costs for each of them.”

As a reminder, the learning rate that we used in the NPRM and this final rule, carried forward from work done for the 2018 NPRM, is based on an assessment of cost reductions due to production volume increases. As we described in the TSD, we identified the change in cost for the estimated changes in production volumes linked to model years and used this rate to develop the learning curves used out to MY 2032, which resulted in an approximately 4.5 percent year over year cost reduction. For MYs 2033 to 2050, we scaled down the learning rate in steps based on literature values and market research.

The parametric analysis presented in the NPRM TSD was meant to confirm that looking at any one potential factor that could have an impact on the battery pack direct manufacturing costs would not have significantly changed this original near-term (*i.e.*, through MY 2032) 4.5 percent production-volume-based learning rate. The parametric analysis showed that considering two factors by themselves—increasing production volume and improving

manufacturing plant efficiency—would result in a slightly shallower learning curve (3.26 and 3.5 percent near-term, year-over-year reductions in cost), while changing battery chemistry by itself would result in a steeper learning curve (5.15 percent near-term, year-over-year cost reductions). Constructing a composite learning curve to consider these three factors in tandem, assuming that the predominant battery chemistry will change over the course of this decade, and also that battery manufacturing plants will become better at producing battery cells—two widely accepted assumptions—confirmed that our original learning curve based on year-over-year production volume increases could reasonably encompass these changes.³⁹¹ Furthermore, while Auto Innovators asserted that our production-based learning curve could miss several important factors, as discussed in Section III.C.6 above and in recent literature,³⁹² a production-volume-based learning curve is an accepted and reasonable method for projecting future costs.

Regarding Auto Innovators’ extensive comments about the impact of materials availability on battery costs, we are aware that the outlook for battery materials has remained uncertain since we released the NPRM. At this time, studies and organizations have provided projections about the impact of battery materials price increases due to supply chain factors and the consensus seems to be that the overall impact on prices will be minimal for the predominant battery chemistries.³⁹³ Our estimated future battery costs are fairly conservative compared to leading analysis firms, even accounting for materials price impacts since the

³⁹¹ See, *e.g.*, MIT Insights into Future Mobility Report, at 77 (“A clear trend within the EV LIB industry is to increase nickel content to boost energy density (for increased driving range) while reducing the amount of expensive cobalt required.”).

³⁹² Lukas Mauler, Fabian Duffner, Wolfgang G Zeier, Jens Leker, “Battery Cost Forecasting: A Review of Methods and Results with an Outlook to 2050,” *Energy and Environmental Science*, 14 (2021) at p. 4724.

³⁹³ Lukas Mauler, Fabian Duffner, Wolfgang G Zeier, Jens Leker, “Battery Cost Forecasting: A Review of Methods and Results with an Outlook to 2050,” *Energy and Environmental Science*, 14 (2021) at p. 4734 (“Every single study that provides time-based projections expects LIB cost to fall, even if increasing raw and battery material prices are taken into account.”); Henze, V., “Battery Pack Prices Fall to an Average of \$132/kWh, But Rising Commodity Prices Start to Bite”, BloombergNEF, November 30, 2021. <https://about.bnef.com/blog/battery-pack-prices-fall-to-an-average-of-132-kwh-but-rising-commodity-prices-start-to-bite/>. Last accessed January 23, 2022.

³⁸⁶ *Id.*, at pp. 94–95.

³⁸⁷ AVE, NHTSA–2021–0053–1488, at pp. 6–7.

³⁸⁸ Auto Innovators, at pp. 97–98.

³⁸⁹ *Id.*, at pp. 119–121.

³⁹⁰ Insights into Future Mobility, MIT Energy Initiative (2019), Cambridge, MA: MIT Energy Initiative, <https://energy.mit.edu/research/mobilityofthefuture/> at p. 76. Accessed January 19, 2022.

NPRM.^{394 395} This makes us confident that our projected battery costs, presented in this final rule, still fall within the scope of reasonable projections for the near-term model years covered by this analysis.

Nonetheless, we do appreciate Auto Innovators' data and analysis submitted on raw materials cost impacts on battery pack costs. We also appreciate the enormity of the task of integrating forecasts of global trends in raw materials prices in our analysis, given that only a minority of the dozens of published battery-forecasting models include any formal analysis of global trends in raw materials prices and none of the published forecasting models have accounted for the increase in material price experienced in 2021. MIT's two-stage model, and multidimensional mathematical models are more refined than single dimensional models due to the use of numerous parameters. However, this comes at the expense of needing to obtain high quality and accurate data for these parameters, potentially at the cost of reduced transparency. For example, MIT's two-stage model requires data from mining companies, materials producers, cell producers, and battery pack producers.³⁹⁶ However, detailed data on these specifics are not readily publicly available.^{397 398 399}

Developing a multi-stage model that can perform the calculations we need for the number of large-scale simulations required by our analysis, with data and assumptions that are transparent and can be made publicly available, would be a difficult task. As discussed above, BatPaC is a publicly

³⁹⁴ See NPRM TSD at 296, Table 3–86—Battery Cost Estimates from Other Sources.

³⁹⁵ Henze, V., "Battery Pack Prices Fall to an Average of \$132/kWh, But Rising Commodity Prices Start to Bite". BloombergNEF, November 30, 2021. <https://about.bnef.com/blog/battery-pack-prices-fall-to-an-average-of-132-kwh-but-rising-commodity-prices-start-to-bite/>. Last accessed January 23, 2022.

³⁹⁶ Insights into Future Mobility, MIT Energy Initiative (2019), Cambridge, MA: MIT Energy Initiative, <https://energy.mit.edu/research/mobilityofthefuture/> at p. 77. Accessed January 19, 2022.

³⁹⁷ S. Matteson and E. Williams, Learning dependent subsidies for lithium-ion electric vehicle batteries, *Technol. Forecast. Soc. Change*, 2015, 92, 322–331.

³⁹⁸ B. Nykvist, F. Sprei and M. Nilsson, Assessing the progress toward lower priced long range battery electric vehicles, *Energy Policy*, 2019, 124, 144–155.

³⁹⁹ Lukas Mauler, Fabian Duffner, Wolfgang G Zeier, Jens Leker, "Battery Cost Forecasting: A Review of Methods and Results with an Outlook to 2050," *Energy and Environmental Science*, 14 (2021) at p. 4715 ("However, details on company-specific prices, costs and profit margins are not publicly available and differences are difficult to assess.").

available model and the inputs and assumptions used to develop and populate BatPaC are publicly available. More specifically, we included detailed data from teardown reports that we used to generate the battery pack inputs for this analysis in the TSD and Argonne Model Documentation. The battery pack designs and cell chemistry that we modeled in BatPaC represented the most common battery pack parameters in the market in MY 2020, our base year for calculating direct manufacturing costs. This approach reflects the same approach we use across our analysis; we do not currently model, for example, the penetration rate of Toyota's HCR engine separately from Mazda's HCR engine. Again, modeling an industry-average system will ensure that, on balance, the analysis captures a reasonable level of costs and benefits that would result from any manufacturer applying the technology. In addition, while Auto Innovators presents important points about the uncertainty regarding the predominant battery chemistry beyond MY 2027, the battery chemistries that we analyzed—NMC622 and NMC811—are still expected to be the dominant chemistries in this rulemaking timeframe. The sensitivity analyses presented in the TSD accompanying the NPRM and this final rule show that analyzing both chemistries separately results in only a small difference in cost between the two options. We see only a small difference in costs because we consider a narrow range of battery pack power and energy sizes in the respective vehicle technology classes.

At this time, we believe that our battery pack costs in this final rule still could reasonably represent costs to the industry during the model years under consideration taking into account the factors mentioned by Auto Innovators. In addition, as discussed further below, our sensitivity cases show that BEV prices remain within a fairly narrow range in the rulemaking timeframe considering potentially higher direct manufacturing costs or shallower learning rates.

We will continue to investigate further refinements to input data and models that we use to assess battery costs as the input data and models continue to develop. We understand that battery technologies and manufacturing processes are undergoing significant development and we will continue to monitor and evaluate battery cost and performance, and how to reflect those trends in our modeling.

For future actions, we would welcome any additional information on the impact of raw materials prices on battery pack costs, including

information on a CBI or public basis on the impact of long-term supply contracts on battery costs.⁴⁰⁰ In particular, we would be interested in more information on whether manufacturers that had contracted for battery packs prior to the 2021 materials supply chain disruptions were insulated from materials cost increases and if there is a contractual or other mechanism within the vehicle manufacturer's control through which vehicle manufacturers could insulate themselves from such disruptions moving forward.⁴⁰¹

As in any large-scale analysis, uncertainties exist. Recognizing that there could be additional factors that constrain battery learning rates, as Auto Innovators suggests, we performed four sensitivity studies around battery pack costs that are described in FRIA Chapter 7.2.2.3. The sensitivity studies examined the impacts of increasing and decreasing the direct cost of batteries and battery learning costs by 20 percent from central analysis levels, based on our survey of external analyses' battery pack cost projections that fell generally within ± 20 percent of our central analysis costs. The average difference in vehicle cost between the reference case and four battery sensitivity cases ranged from $-\$52$ to $\$128$. This means that, even accounting for potential unanalyzed factors related to battery prices, we expect battery electric vehicle prices to remain within a fairly narrow range in the rulemaking timeframe. These sensitivity outcomes are similar

⁴⁰⁰ C. Xu, et al., Future material demand for automotive lithium-based batteries, *Commun. Mater.*, 2020, 1, 99.; H. Hao, et al., Impact of transport electrification on critical metal sustainability with a focus on the heavy-duty segment, *Nat. Commun.*, 2019, 10, 5398.; Reuters. "Stellantis, LG Energy Solution to form battery JV for North America." *Automotive News*, October 18, 2021. <https://www.autonews.com/manufacturing/stellantis-lg-energy-solution-form-battery-jv-north-america>. Last accessed 01/20/2022.; "Daimler, Stellantis enter agreement with battery maker Factorial Energy." *Automotive News*, November 30, 2021. <https://www.autonews.com/suppliers/why-daimler-stellantis-are-investing-battery-maker>. Last accessed January 20, 2022.; "FORD COMMITS TO MANUFACTURING BATTERIES, TO FORM NEW JOINT VENTURE WITH SK INNOVATION TO SCALE NA BATTERY DELIVERIES." *Ford Media Center*, May 20, 2021. <https://media.ford.com/content/fordmedia/fna/us/en/news/2021/05/20/ford-commits-to-manufacturing-batteries.html>. Last accessed January 20, 2022.; "Toyota Selects North Carolina for New U.S. Automotive Battery Plant." *Toyota Newsroom*, December 7, 2021. <https://global.toyota/en/newsroom/corporate/36418723.html>. Last accessed January 20, 2022.

⁴⁰¹ See, e.g., Lukas Mauler, Fabian Duffner, Wolfgang G Zeier, Jens Leker, "Battery Cost Forecasting: A Review of Methods and Results with an Outlook to 2050," *Energy and Environmental Science*, 14 (2021) at p. 4724; ("In the battery industry-prices are further influenced by strategic pricing, long-term contracts and rebates to utilize excess production capacity.").

to those we showed in the NPRM sensitivity analysis. Although Auto Innovators showed how an increase in individual raw material cost could impact the final cost, we believe that at the total pack level the 20 percent high sensitivity case encompasses these situations in the rulemaking time frame. Again, these results, in addition to the consensus in literature regarding the impact of rising materials prices on future costs described above, make us comfortable that our approach to estimating battery costs is a reasonable approach for this final rule analysis.

After pointing out the BatPaC model's limitations regarding future potential increases in materials costs, Auto Innovators commented that we should use BatPaC to estimate battery pack costs for BEV400 and BEV500 technologies instead of scaling up BEV300 battery pack costs.⁴⁰² Beyond the request to do so, we received no updated real-world data on the cost and weight of battery packs used in 400- and 500-mile range electric vehicles. As discussed above, and as originally stated in the NPRM, initial values from BatPaC could not be validated by real-world data, leading us to continue using the scaled values for the final rule.

Auto Innovators identified other costs related to electric vehicles (EVs) that they stated our analysis does not consider; specifically, they stated that our battery-price estimates are industry averages that do not exclude supply chains that fail environmental, social, and governance (ESG) tests. Auto Innovators stated that “for the major global automakers that operate in the [U.S.] auto market, the RIAs should not assume that low-cost suppliers with poor ESG profiles can be utilized in EV supply chains.” Auto Innovators also identified the shift from recycling engines and transmissions to recycling EV batteries, as well as the price of electricity to produce EV batteries, as costs that we do not currently account for. In addition, Auto Innovators stated that the BEVs and PHEVs are a new technology type for many drivers and, as a result, drivers may incur some costs and inconveniences that we should consider as part of our analysis.⁴⁰³ They provided three examples of costs to the user beyond the purchase price: (1) Costs of charging stations for BEVs and PHEVs; (2) costs to the user of a vehicle that has a shorter driving range than the typical conventional IC engine and that requires a long time to charge, and (3) the time spent charging.

We applaud Auto Innovators members for including serious ESG considerations in their planning for developing battery supply chains. However, like the issues surrounding raw materials impacts discussed above, we currently do not have a specific mechanism to account for the cost of supply chains that pass basic ESG tests, as Auto Innovators suggests. To the extent that Auto Innovators members have already entered into contracts with battery suppliers and have included ESG terms in those contracts, and have data or other information on how that increases the costs for EV production over and above an industry average that we would project quantitatively, we welcome that information for future analysis. We will continue to research these factors and consider whether to include them in the cost-benefit analysis. We support Auto Innovators and any individual component or vehicle manufacturer providing the agency with supporting material for these specific topics.

As a reminder, our analysis considers technology costs that vehicle manufacturers ultimately pass to the buyer separately from the user costs for a technology, like fueling from either gasoline or electricity. We consider many externalities that accrue cost for the consumer in the analysis, and these are discussed in Section III.E. We specifically identified a cost to the user for time spent charging an EV, which is discussed further in that section. However, regardless of where we account for those costs in the analysis, we believe those costs would be minimal in the timeframe of this rulemaking considering the standard-setting projections of EV and PHEV penetration rates, which are discussed further in FRIA Chapter 6.3.1. That said, for future rules we appreciate any new data Auto Innovators and other stakeholders can provide to develop more precise electric vehicle user costs.

Next, ICCT commented that we “erroneously inflated battery costs by applying the retail price equivalent (RPE) markup to base costs that already include indirect costs.”⁴⁰⁴ We disagree. The indirect costs represented in BatPaC output are those that apply to the battery supplier, and do not represent the indirect costs experienced by the OEM who purchases the battery and integrates it into the vehicle. NHTSA has always considered RPE markup to be applicable to purchased items.

We also believe that the warranty costs are appropriately marked up with the BatPaC outputs. The RPE markup

factor is based on an examination of historical financial data contained in 10-K reports filed by manufacturers with the Securities and Exchange Commission. It represents the ratio between the retail price of motor vehicles and the direct costs of all activities that manufacturers engage in, including the design, development, manufacturing, assembly, and sales of new vehicles, refreshed vehicle designs, and modifications to meet safety or fuel economy standards. An RPE of 1.5 does not imply that manufacturers automatically mark up each vehicle by exactly 50 percent. Rather, it means that, over time, the competitive marketplace has resulted in pricing structures that average out to this relationship across the entire industry. Prices for any individual model may be marked up at a higher or lower rate depending on market demand. The consumer who buys a popular vehicle may, in effect, subsidize the installation of a new technology in a less marketable vehicle. But, on average, over time and across the vehicle fleet, the retail price paid by consumers has risen by about \$1.50 for each dollar of direct costs incurred by manufacturer.

The direct costs associated with any specific technology will change over time as some combination of learning and resource price changes occurs. Resource costs, such as the price of steel, can fluctuate over time and can experience real long-term trends in either direction, depending on supply and demand. However, the normal learning process generally reduces direct production costs as manufacturers refine production techniques and seek out less costly parts and materials for increasing production volumes. By contrast, this learning process does not generally influence indirect costs. To be consistent with the basis for the RPE multiplier, we apply learning to direct costs, and then mark up the resulting learned direct costs using the RPE multiplier.

We consulted Argonne and the BatPaC manual and as shown in the BatPaC documentation, the final cost provided by the BatPaC model includes two-part variable costs (what we consider direct costs) and fixed expenses (what we consider indirect costs). Table 8.7 in the BatPaC Model Documentation shows the breakdown of the costs and the approximate percentage of each cost.

These costs combine to provide the overall cost of the battery pack from the supplier to the OEM. The cost of the battery pack from the supplier to the OEM is considered a direct cost to the OEM, like any other part that an OEM

⁴⁰² Auto Innovators, at p. 119.

⁴⁰³ *Id.*, at pp. 119–121.

⁴⁰⁴ ICCT, at p. 8.

acquires from other suppliers. In turn, while using the battery pack in the finished vehicle, the OEM will incur indirect costs including research and development (R&D), general sales and administrative costs (GSA), as well as warranty and profit. Thus, the indirect costs associated with components or subsystems incurred by the automotive suppliers should not be conflated with vehicle manufacturer indirect costs.

Supplier warranty costs should reflect losses they experience to replace defective battery packs or parts. Likewise, OEM warranty costs should reflect actual losses they incur in replacing defective parts. OEM losses are partially reimbursed by supplier warranties. Both OEM warranty costs and supplier warranty costs should thus represent the net loss to each business due to warranty coverage. OEM warranty costs should thus already reflect reimbursement to OEMs from supplier warranties, implying that reflecting warranty costs within the direct cost of the product and separate warranty costs at the OEM level is not double counting. Accordingly, we did not make any changes to how indirect cost markups are applied to the BatPaC costs for this final rule.

In sum, after considering the comments received on how we modeled battery pack costs, we determined that it was appropriate to use the same battery costs for this final rule. We will perform additional research and update our analysis accordingly for future analyses.

Turning to electrification costs that are non-battery related, each vehicle powertrain type receives different non-battery electrification components. When researching costs for different non-battery electrification components, we found that different reports vary in components considered and cost breakdown. This is not surprising, as vehicle manufacturers use different non-battery electrification components in different vehicle's systems, or even in the same vehicle type, depending on the application.⁴⁰⁵ We use costs for the major non-battery electrification components on a dollar per kilowatt basis based on the costs presented in two reports. We use a \$/kW cost metric for non-battery components to align with the normalized costs for a system's peak power rating as presented in U.S. DRIVE's Electrical and Electronics Technical Team (EETT) Roadmap

⁴⁰⁵ For example, the MY 2020 Nissan Leaf does not have an active cooling system whereas Chevy Bolt uses an active cooling system.

report.⁴⁰⁶ This approach captures components in some manufacturer's systems, but not all systems; however, we believe this is a reasonable metric and approach to use for this analysis given the differences and complexities in non-battery electrification systems. This approach allows us to scale the cost of non-battery electrification components based on the requirements of the system to meet vehicle utility and performance requirements. We also rely on a MY 2016 Chevrolet Bolt teardown study for some categories of strong hybrid component costs and all other PHEV and BEV non-battery component costs that were not explicitly estimated in the EETT Roadmap report.⁴⁰⁷

We received several comments specific to strong hybrid non-battery electrification technology costs, in particular regarding the costs of eCVTs and high voltage cables.

Tesla stated that it believes that non-battery electrification components that add to the total cost required to electrify a vehicle continue to decrease in price and are utilized across vehicle types and EVs are rapidly approaching price parity with ICE technology.⁴⁰⁸

American Council for an Energy-Efficient Economy (ACEEE) commented that the cost to manufacture hybrid vehicles has fallen significantly in recent years, more so than NHTSA's analysis assumes.⁴⁰⁹ They stated that the incremental hybridization costs used in this rule are significantly higher than those assessed by the 2021 NAS Report. Specifically, they stated that when accounting for differing assumptions, the costs assumed by this rule are 20 percent higher.

Toyota commented that "NHTSA's estimated costs are significantly higher than Toyota's understanding based on our current products and experience developing and marketing hybrids systems over the last two decades. The estimated costs for power split hybrids used as an input to compliance modeling for the proposed standards are more than twice the cost estimates in the National Academies of Science Engineering and Medicine (NASEM) 2025–2035 CAFE Study."⁴¹⁰ They added "NHTSA's projected power split system costs are always significantly

⁴⁰⁶ U.S. DRIVE, Electrical and Electronics Technical Team Roadmap (Oct. 2017), available at <https://www.energy.gov/sites/prod/files/2017/11/f39/EETT%20Roadmap%2010-27-17.pdf>.

⁴⁰⁷ Hummel et al., UBS Evidence Lab Electric Car Teardown—Disruption Ahead?, UBS (May 18, 2017), <https://neo.ubs.com/shared/d1wkuDIEbYPjF/> (accessed: Feb. 11, 2022).

⁴⁰⁸ Tesla, at pp. 9–10.

⁴⁰⁹ ACEEE, Docket No. NHTSA–2021–0053–0074, at p. 5.

⁴¹⁰ Toyota, at pp. 7–8.

higher than P2 system costs for the same vehicle class. Toyota's experience is that the relative cost of the power split and P2 systems depends on vehicle class and operational requirements, and that for many applications power split and P2 system costs are much more similar than NHTSA's estimates suggest." They further added "Once adjusted for future cost savings, NHTSA's 2020 hybrid costs are still typically double the NASEM estimates. Further, the NASEM committee estimates the incremental cost of midsize and crossover strong hybrids in 2020 model year to be \$2,000 to 3,000 more than a conventional vehicle which is well below NHTSA's 2020 power split estimate," and "Toyota believes the NASEM 2025 model year cost values are more representative of hybrid vehicle costs through the 2026 model year, including any accompanying engine developments and normalization for differences in component sizes and assessment methodologies. We disagree that engine upgrades should account for a large portion of the difference between the NASEM and NHTSA cost estimates. Such a significant cost difference does not exist for Toyota's 2.5L Dynamic Force engine used in the hybrid and non-hybrid versions of the 2021 model year Camry referenced by NHTSA."

ICCT also commented on cost estimates for the power-split hybrid, stating that "NHTSA has substantially overestimated the costs of full hybrid vehicles, as eCVT costs are far lower than the CVTL2 costs assumed by NHTSA; NHTSA's high-voltage cable cost is more than twice that of both NAS and FEV; NHTSA's battery size and cost are overstated, as they do not take into account power density improvements that cut the size and cost of strong hybrid battery packs in half; and NHTSA's analysis has \$432 for power electronics and thermal management that appear to be already included in motor/inverter/generator/regen brake costs for NAS and FEV."⁴¹¹

We agree with Tesla that there are many non-battery components that are shared across different vehicle lines, and this provides an opportunity for cost reductions over time from economies of scale. We capture cost reductions for non-battery electrification components through a learning curve Section III.C.6. We will continue to monitor trends and other information related to non-battery components.

Based on the comments specific to hybrid vehicle non-battery component costs, as well as data from the 2021 NAS Report, we reexamined the costs for

⁴¹¹ ICCT, at p. 10.

non-battery components. For this final rule, we updated the cost of an eCVT for SHEVPS vehicles, as well as the costs of high voltage cables for all strong hybrid vehicles.

Previously, we had used the cost of a CVTL2 as a proxy for the eCVT; for this final rule, the eCVT cost comes from data in the EPA-sponsored teardown study of a 2011 Ford Fusion strong hybrid,⁴¹² and has been adjusted to 2018\$. This cost also aligns with the eCVT cost presented in the 2021 NAS Report.

We also used data from the 2011 Ford Fusion teardown study to adjust the cost of SHEVP2 and SHEVPS high voltage cables. This adjustment brought our high voltage cable costs in closer proximity to the 2021 NAS Report high voltage cable costs. More details about the updated costs can be found in TSD Chapter 3.3.5.3. The resulting cost differences between the SHEVP2 and SHEVPS hybrid systems is mainly associated with the fact that our analysis considers two motors/generators for SHEVPS and one motor/generator for SHEVP2. We discuss how SHEVPS and SHEVP2 are characterized in our analysis in Section III.D.3.a).

As a reminder, the assumptions that we use to model and simulate strong hybrid vehicles in Autonomie are not specific to any one manufacturer's vehicle type. The engines and/or electric motors are sized to meet different characteristics like utility, performance, and other key designs to provide the highest system efficiency. These key characteristics and attributes are discussed in detail in Section III.C.4. This results in costs that may not match one specific vehicle teardown. However, we still believe that on average the system cost estimates are appropriate.

We agree with Toyota that in some cases a vehicle's engine does not change when going from a conventional powertrain to hybrid powertrain, like Toyota's example of the 2.5L naturally aspirated engine in the RAV4 and RAV4 hybrid. However, the analysis fleet consists of vehicles with an assortment of engines that are as basic as VVT-only

to as advanced as VCR. In some cases, a vehicle that starts with a basic conventional engine that adopts SHEVP2 system could also adopt a more advanced engine. For example, the 2022 Hyundai Tucson base engine is a 2.5L naturally aspirated engine and its turbo version engine is a downsized turbocharged engine.⁴¹³ We allow the CAFE Model to both upgrade and downgrade the engine associated with SHEVP2 powertrains to apply the ICE engine that is most cost effective with the hybrid system. The details of these scenarios discussed further in Sections III.D.3.a) and III.D.3.c) for SHEVs.

Finally, we use Autonomie and BatPaC to model the size and cost of batteries used in strong hybrid vehicles. More details on the sizing algorithm and battery costs can be found in the Argonne model documentation as well as in TSD Chapter 3.3.5.1.

We received another comment from ICCT stating that "for 2018 Mid Term Evaluation, non-battery BEV and PHEV costs were updated based on more recent teardown data from California Air Resources Board, UBS, and other references, but these updated costs were not used in the proposed NHTSA rule."⁴¹⁴

Although ICCT references multiple studies in their comment, they do not provide any specific BEV and PHEV component costs that they believe are estimated incorrectly in our analysis. As discussed earlier and in TSD Chapter 3.3.5.2, we have used the most recent public data available to estimate the cost of non-battery electrification components. In particular, we rely on the UBS teardown study that ICCT references for some BEV and PHEV components.

To develop the learning curves for non-battery electrification components, we used cost information from Argonne's 2016 Assessment of Vehicle Sizing, Energy Consumption, and Cost through Large-Scale Simulation of Advanced Vehicle Technologies

report.⁴¹⁵ The report provided estimated cost projections from the 2010 lab year to the 2045 lab year for individual vehicle components.^{416 417} We considered the component costs used in electrified vehicles, and determined the learning curve by evaluating the year over year cost change for those components. Argonne published a 2020 version of the same report that included high and low-cost estimates for many of the same components, that also included a learning rate.⁴¹⁸ Our learning estimates generated using the 2016 report fall fairly well in the middle of these two ranges, and therefore we decided that continuing to apply the learning curve estimates based on the 2016 report was reasonable. There are many sources that we could have picked to develop learning curves for non-battery electrification component costs, however given the uncertainty surrounding the complexity of the systems and extrapolating costs out to MY 2050, we believe these learning curves provide a reasonable estimate.

Table III–19 shows an example of how the non-battery electrification component costs are computed for the Medium Car and Medium SUV non-performance vehicle classes for the final rule analysis.

BILLING CODE 4910–59–P

⁴¹⁵ Moawad, Ayman, Kim, Namdoo, Shidore, Neeraj, and Rousseau, Aymeric. Assessment of Vehicle Sizing, Energy Consumption and Cost Through Large Scale Simulation of Advanced Vehicle Technologies (ANL/ESD–15/28). United States (2016). Available at <https://www.autonomie.net/pdfs/Report%20ANL%20ESD-1528%20-%20Assessment%20of%20Vehicle%20Sizing,%20Energy%20Consumption%20and%20Cost%20through%20Large%20Scale%20Simulation%20of%20Advanced%20Vehicle%20Technologies%20-%201603.pdf>. (accessed: Feb. 11, 2022).

⁴¹⁶ ANL/ESD–15/28, at p. 116.

⁴¹⁷ DOE's lab year equates to five years after a model year, e.g., DOE's 2010 lab year equates to MY 2015.

⁴¹⁸ Islam, E., Kim, N., Moawad, A., Rousseau, A. "Energy Consumption and Cost Reduction of Future Light-Duty Vehicles through Advanced Vehicle Technologies: A Modeling Simulation Study Through 2050", Report to the U.S. Department of Energy, Contract ANL/ESD–19/10, June 2020 <https://www.autonomie.net/pdfs/ANL%20-%20Islam%20-%202020%20-%20Energy%20Consumption%20and%20Cost%20Reduction%20of%20Future%20Light-Duty%20Vehicles%20through%20Advanced%20Vehicle%20Technologies%20A%20Modeling%20Simulation%20Study%20Through%202050.pdf>. (accessed: Feb. 11, 2022).

⁴¹² EPA. "Light Duty Technology Cost Analysis, Power-Split and P2 HEV Case Studies." November 2011. EPA–420–R–11–015. <https://nepis.epa.gov/Exe/ZyPDF.cgi/P100EG1R.PDF?Dockey=P100EG1R.PDF>. (Accessed: Dec. 3, 2021)

⁴¹³ Lorio, J., "Tested: 2022 Hyundai Tucson Hybrid Aids Mileage and Performance." Car and Driver. December 22, 2021. <https://www.caranddriver.com/reviews/a38591574/2022-hyundai-tucson-hybrid-by-the-numbers/>. (Accessed: Dec. 29, 2021)

⁴¹⁴ ICCT, at pp. 7–8.

Table III-19 – Example Non-Battery Components for Medium Car and SUV Non-Performance Classes

Electric Powertrain	Traction Motor calculated using Peak Power (kW)	Motor-Generator calculated using	Total Cost of ETDS (Motor and Inverter)	DC to DC Converter	On-board Charger	Power Distribution Cables	Total DMC of Electrical Components	Total Electrification RPE	DMC of eCVT or AT8L2	RPE Cost of eCVT or AT8L2	Total Electrification Cost (DMC)	Total Electrification Cost (RPE) - from Technologies file
Medium Car – Non-Performance												
SHEVP2	28.01	0	\$516	\$184	\$0	\$168	\$868	\$1,171	\$1,655	\$2,473	\$2,523	\$3,625
PHEV20T	38.95	0	\$717	\$184	\$174	\$460	\$1,536	\$2,027	\$1,655	\$2,473	\$3,191	\$4,457
PHEV50T	95.21	0	\$1,753	\$184	\$174	\$460	\$2,572	\$3,395	\$1,655	\$2,473	\$4,227	\$5,817
SHEVPS	72.62	37.61	\$2,030	\$184	\$0	\$168	\$2,382	\$3,180	\$1,084	\$1,619	\$3,465	\$4,812
PHEV20	74.66	38.92	\$2,091	\$184	\$174	\$460	\$2,910	\$3,841	\$1,686	\$2,518	\$4,596	\$6,345
Medium SUV – Non-Performance												
SHEVP2	29.14	0	\$537	\$184	\$0	\$168	\$888	\$1,199	\$1,655	\$2,473	\$2,543	\$3,653
PHEV20T	43.32	0	\$798	\$184	\$174	\$460	\$1,616	\$2,133	\$1,655	\$2,473	\$3,271	\$4,563
PHEV50T	110.72	0	\$2,039	\$184	\$174	\$460	\$2,857	\$3,772	\$1,655	\$2,473	\$4,512	\$6,194
SHEVPS	79.32	41.74	\$2,229	\$184	\$0	\$168	\$2,581	\$3,446	\$1,084	\$1,619	\$3,665	\$5,078
PHEV20	81.81	43.01	\$2,298	\$184	\$174	\$460	\$3,117	\$4,114	\$1,686	\$2,518	\$4,803	\$6,618

TSD Chapter 3.3.5.2 contains more information about the non-battery electrification components relevant to each specific electrification technology and the sources used to develop these costs.

Finally, the cost of electrifying a vehicle depends on the other powertrain components that must be added or removed from a vehicle with the addition of the electrification technology. Table III–20 below provides

a breakdown of each electrification component included for each electrification technology type, as well as where to find the costs in each CAFE Model input file.

Table III-20 – Breakdown of the Electrification Costs by Electrification Technology Type

Electrification Technology Type	Technologies File Vehicle Tabs	Technologies File Engine Tabs	Battery Cost File
Micro Hybrid	Motor/generator	N/A	Battery Pack ⁴¹⁹
Mild Hybrid	Motor/generator, DC/DC converter, other components	N/A	Battery Pack
P2 Strong Hybrid	DC/DC converter, on-board charger, high voltage cables, e-motor, AT8L2 transmission, and power electronics	IC engine*	Battery Pack
PS Strong Hybrid	DC/DC converter, on-board charger, high voltage cables, e-motor, eCVT transmission, and power electronics	IC engine	Battery Pack
Plug-in Hybrid (PHEV 20T/50T)	DC/DC converter, on-board charger, high voltage cables, e-motor, AT8L2 transmission, and power electronics	IC engine	Battery Pack
Plug-in Hybrid (PHEV 20/50 and 20H/50H)	DC/DC converter, on-board charger, high voltage cables, e-motor, CVTL2 transmission, and power electronics	IC engine	Battery Pack
BEVs	DC/DC converter, on-board charger, high voltage cables, e-motor	ETD System	Battery Pack
FCEVs	Fuel cell system, e-motor, H ₂ Tank, transmission, and power electronics	N/A	N/A

*The engine cost for a P2 Hybrid is based on engine technology that is used in the conventional powertrain.

The following example in Table III–21 shows how the costs are computed for a vehicle that progresses from a lower level to a higher level of electrified powertrain. The table shows the components that are removed and the components that are added as a GMC

Acadia progresses from a MY 2024 vehicle with only SS12V electrification technology to a BEV300 in MY 2025.⁴²⁰ The total cost in MY 2025 is a net cost addition to the vehicle. The same methodology could be used for any other technology advancement in the

electric technology tree path. For the final rule analysis, the cost of the SS12V battery was updated as discussed earlier, and this example has been updated to show the new cost.

⁴¹⁹ As discussed in section 3.3.5.3 of the TSD, we no longer use the BatPaC SS12V battery cost and use a cheaper AGM battery instead, and the

updated cost is reflected in the battery__costs.csv file.

⁴²⁰ Vehicle code 11001008 in the Vehicle Report output file.

Table III-21 – Technology Cost Change for GMC Acadia Example

	Technology Removed	Technology Added	MY 2025 Cost of Technology (2018\$)	MY 2025 Overall Technology Cost (2018\$)
MY 2024				888.7
Removed Technologies	Engine (DOHC)		(5830.76)	(5482.2)
	VVT		(221.54)	(5703.74)
	SGDI		(501.67)	(6205.41)
	DEAC		(203.35)	(6408.76)
	Transmission (AT9L2)		(2498.29)	(8907.05)
	EPS		(117.28)	(9024.33)
	SS12V		(247.43)	(9271.76)
	SS12V battery		(146.90)	(9418.66)
	AERO0		(0)	(9418.66)
Added Technologies		BEV300 - ETDS	3581.65	(5837.01)
		IACC	146.68	(5690.33)
		Non-battery components	1137.67	(4552.66)
		Battery Pack Cost	17955.29	13402.63
		AERO20	248.9	13651.53
	Total AC/OC Adjustments ⁴²¹	72.71	13696.96	
MY 2025				13696.96

TSD Chapter 3.3.5.3 includes more details about how the costs associated with the internal combustion engine, transmission, electric machine(s), non-battery electrification components, and battery pack for each electrified technology type are combined to create a full electrification system cost.

Mass Reduction

Mass reduction is a relatively cost-effective means of improving fuel economy, and vehicle manufacturers are expected to apply various mass reduction technologies to meet fuel economy standards. Reducing vehicle mass is accomplished through several different techniques, such as modifying and optimizing vehicle component and system designs, part consolidation, and adopting lighter weight materials (advanced high strength steel, aluminum, magnesium, and plastics

⁴²¹ Please note that in this calculation the CAFE Model accounts for the air conditioning and off-cycle technologies (g/mile) applied to each vehicle model. The cost for the AC/OC adjustments are located in the CAFE Model Scenarios file. The air conditioning and off-cycle cost values are discussed further in TSD Chapter 3.8.

including carbon fiber reinforced plastics).

The cost for mass reduction depends on the type and amount of materials used, the manufacturing and assembly processes required, and the degree to which changes to plants and new manufacturing and assembly equipment is needed. In addition, manufacturers may develop expertise and invest in certain mass reduction strategies that may affect the approaches for mass reduction they consider and the associated costs. Manufacturers may also consider vehicle attributes like noise-vibration-harshness (NVH), ride quality, handling, crash safety and various acceleration metrics when considering how to implement any mass reduction strategy. These are considered to be aspects of performance, and for this analysis any identified pathways to compliance are intended to maintain performance neutrality. Therefore, mass reduction via elimination of, for example, luxury items such as climate control, or interior vanity mirrors, leather padding, etc., is not considered

in the mass reduction pathways for this analysis.

The automotive industry uses different metrics to measure vehicle weight. Some commonly used measurements are vehicle curb weight,⁴²² gross vehicle weight (GVW),⁴²³ gross vehicle weight rating (GVWR),⁴²⁴ gross combined weight (GCVW),⁴²⁵ and equivalent test weight (ETW),⁴²⁶ among others. The vehicle curb weight is the most commonly used

⁴²² This is the weight of the vehicle with all fluids and components but without the drivers, passengers, and cargo.

⁴²³ This weight includes all cargo, extra added equipment, and passengers aboard.

⁴²⁴ This is the maximum total weight of the vehicle, passengers, and cargo to avoid damaging the vehicle or compromising safety.

⁴²⁵ This weight includes the vehicle and a trailer attached to the vehicle, if used.

⁴²⁶ For the EPA two-cycle regulatory test on a dynamometer, an additional weight of 300 lbs. is added to the vehicle curb weight. This additional 300 lbs. represents the weight of the driver, passenger, and luggage. Depending on the final test weight of the vehicle (vehicle curb weight plus 300 lbs.), a test weight category is identified using the table published by EPA according to 40 CFR 1066.805. This test weight category is called "Equivalent Test Weight" (ETW).

measurement when comparing vehicles. A vehicle's curb weight is the weight of the vehicle including fluids, but without a driver, passengers, and cargo. A vehicle's glider weight, which is vehicle curb weight minus the powertrain weight, is used to track the potential opportunities for weight reduction not including the powertrain. A glider's subsystems may consist of the vehicle body, chassis, interior, steering, electrical accessory, brake, and wheels systems. The percentage of weight assigned to the glider will remain constant for any given rule but may change overall. For example, as electric

powertrains including motors, batteries, inverters, etc. become a greater percent of the fleet, glider weight percentage will change compared to earlier fleets with higher dominance of ICE powertrains.

For this analysis, NHTSA considers six levels of mass reduction technology that include increasing amounts of advanced materials and mass reduction techniques applied to the glider. NHTSA accounts for changes in mass associated with powertrain changes separately. The following sections discuss the assumptions for the six mass reduction technology levels, the process

used to assign initial analysis fleet mass reduction assignments, the effectiveness for applying mass reduction technology, and mass reduction costs.

(a) Mass Reduction in the CAFE Model

The CAFE Model considers six levels of mass reduction technologies that manufacturers could use to comply with CAFE standards. The magnitude of mass reduction in percent for each of these levels is shown in Table III-22 for mass reductions for light trucks, passenger cars and for gliders.

BILLING CODE 4910-59-C

Table III-22 – Mass Reduction Technology Level and Associated Glider and Curb Mass Reduction

MR Level	Percent Glider Weight	Percent Vehicle Curb Weight (Passenger Cars)	Percent Vehicle Curb Weight (Light Trucks)
MR0	0%	0.00%	0.00%
MR1	5%	3.55%	3.55%
MR2	7.5%	5.33%	5.33%
MR3	10%	7.10%	7.10%
MR4	15%	10.65%	10.65%
MR5	20%	14.20%	14.20%
MR6	28%	20.00%	20.00%

For this analysis, NHTSA considers mass reduction opportunities from the glider subsystems of a vehicle first, and then consider associated opportunities to downsize the powertrain, which are accounted for separately.⁴²⁷ As explained below, in the Autonomie simulations, the glider system includes both primary and secondary systems from which a percentage of mass is reduced for different glider weight reduction levels; specifically, the glider includes the body, chassis, interior, electrical accessories, steering, brakes and wheels. In this analysis, NHTSA assumes the glider share is 71 percent of vehicle curb weight. The Autonomie model sizes the powertrain based on the glider weight and the mass of some of the powertrain components in an iterative process. The mass of the powertrain depends on the powertrain size. Therefore, the weight of the glider impacts the weight of the powertrain.⁴²⁸

⁴²⁷ When the mass of the vehicle is reduced by an appropriate amount, the engine may be downsized to maintain performance. See Section III.C.4 for more details.

⁴²⁸ Since powertrains are sized based on the glider weight for the analysis, glider weight reduction beyond a threshold amount during a redesign will lead to re-sizing of the powertrain. For the analysis, the glider was used as a base for the

NHTSA uses glider weight to apply non-powertrain mass reduction technology in the CAFE Model and use Autonomie simulations to determine the size of the powertrain and corresponding powertrain weight for the respective glider weight. The combination of glider weight (after mass reduction) and re-sized powertrain weight equal the vehicle curb weight.

While there are a range of specific mass reduction technologies that may be applied to vehicles to achieve each of the six mass reduction levels, there are some general trends that are helpful to illustrate some of the more widely used approaches. Typically, MR0 reflects vehicles with widespread use of mild steel structures and body panels, and very little or no use of high strength steel or aluminum. MR0 reflects materials applied to average vehicles in the MY 2008 timeframe. MR1–MR3 can be achieved with a steel body structure.

application of any type of powertrain. A conventional powertrain consists of an engine, transmission, exhaust system, fuel tank, radiator, and associated components. A hybrid powertrain also includes a battery pack, electric motor(s), generator, high voltage wiring harness, high voltage connectors, inverter, battery management system(s), battery pack thermal system, and electric motor thermal system.

In going from MR1 to MR3, expect that mild steel to be replaced by high strength and then advanced high strength steels. In going from MR3 to MR4 aluminum is required. This will start at using aluminum closure panels and then to get to MR4 the vehicle's primary structure will need to be mostly made from aluminum. In the vast majority of cases, carbon fiber technology is necessary to reach MR5, perhaps with a mix of some aluminum. MR6 requires nearly every primary structural component of the vehicle, like body structure and closure panels, be made from carbon fiber. There may be some use of aluminum in the suspension components. TSD Chapter 3.4 includes more discussion of the challenges involved with adopting large amounts of carbon fiber in the vehicle fleet.

Arconic Corporation commented that "the NPRM makes specific references to aluminum, which are accurate and consistent with practical automotive industry experience and future program expectations. Mass reduction utilizing advanced materials like aluminum is recognized as one of the technology options to achieve safe, fuel-efficient

and cost-effective vehicles that meet or exceed consumer demands.”⁴²⁹

The American Chemistry Council (ACC) commented on the agency’s statements about vehicle light-weighting in several respects, but particularly disagreeing with our analysis of mass reduction technology levels.⁴³⁰ Specifically, ACC stated that “as written, the NPRM could be construed as NHTSA discouraging the use of carbon fiber composites as well as an endorsement for utilizing steel and aluminum-based designs to achieve mass reduction.”⁴³¹ ACC also provided updated data on carbon fiber costs from DOE ORNL studies that they asked the agency to consider in the final rule.

To be clear, our analysis does not endorse any specific technology solution or pathway over another. However, our analysis does need to accurately reflect trends that are developing in the real-world automotive marketplace and potential fuel economy improving technology to appropriately estimate the costs and benefits of more stringent standards. It also does need to consider what could reasonably occur in the future of the market given automotive development timelines for implementing new technology into real passenger vehicles. Precursor materials technologies that potentially offer game-changing dry carbon fiber cost reductions are still under development and therefore we would not expect them to end up in a production vehicle program beyond what our adoption features allow in the rulemaking timeframe.

In addition, while carbon fiber composites are considered a potential pathway to compliance, wholly carbon fiber primary structure, which is what is necessary to reduce mass enough to achieve the highest mass reduction levels in the analysis, simply have not materialized. While the number and mass of discrete applications of carbon fiber has expanded the fleet—for example, adding carbon fiber decorative interior trim pieces or carbon fiber roof panels to medium and high-end luxury cars—these discrete applications do not contribute to substantial mass reduction required to meet the highest levels of mass reduction in this analysis. The price to apply carbon fiber technology to produce wholly carbon fiber composite primary structure with the precursor material available today has not yet dropped to a price that would make it

cost-effective for the industry to apply to meet more stringent fuel economy standards. This fact is corroborated by the 2021 NAS Report, which provided updated data for carbon fiber composite costs that show the technology has not yet dropped to a price that would make it cost-effective for the industry to apply to meet more stringent fuel economy standards. This is discussed further in Section III.D.4.c) below. We also appreciate ACC’s inclusion of the DOE ORNL technoeconomic analysis on carbon fiber and discuss the study further in Section III.D.4.e) below.

As discussed further below, the cost studies used to generate the cost curves assume mass can be reduced in levels that require utilizing different materials and modifying different components, in a specific order. NHTSA’s mass reduction levels are loosely based on what materials and component modifications are required for each percent of mass reduction, based on the conclusions of those studies.

(b) Mass Reduction Analysis Fleet Assignments

To assign baseline mass reduction levels (MR0 through MR6) for vehicles in the MY 2020 analysis fleet, NHTSA uses previously developed regression models to estimate curb weight for each vehicle based on observable vehicle attributes. NHTSA uses these models to establish a baseline (MR0) curb weight for each vehicle, and then determines the existing mass reduction technology level by finding the difference between the vehicles actual curb weight to the estimated regression-based value, and comparing the difference to the values in Table III–22. NHTSA originally developed the mass reduction regression models using MY 2015 fleet data; for this analysis, NHTSA used MY 2016 and 2017 analysis fleet data to update the models.

NHTSA believes the regression methodology is a technically sound approach for estimating mass reduction levels in the analysis fleet. For a detailed discussion about the regression development and use please see TSD Chapter 3.4.2.

Manufacturers generally apply mass reduction technology at a vehicle platform level (*i.e.*, using the same components across multiple vehicle models that share a common platform) to leverage economies of scale and to manage component and manufacturing complexity, so conducting the regression analysis at the platform level leads to more accurate estimates for the real-world vehicle platform mass reduction levels. The platform approach also addresses the impact of potential

weight variations that might exist for specific vehicle models, as all the individual vehicle models are aggregated into the platform group, and are effectively averaged using sales weighting, which minimizes the impact of any outlier vehicle configurations.

(c) Mass Reduction Adoption Features

Given the degree of commonality among the vehicle models built on a single platform, manufacturers do not have complete freedom to apply unique mass reduction technologies to each vehicle model that shares the platform. While some technologies (*e.g.*, low rolling resistance tires) are very nearly “bolt-on” technologies, others involve substantial changes to the structure and design of the vehicle, and therefore affect all vehicle models that share a platform. In most cases, mass reduction technologies are applied to platform level components and therefore the same design and components are used on all vehicle models that share the platform.

Each vehicle in the analysis fleet is associated with a specific platform. Similar to the application of engine and transmission technologies, the CAFE Model defines a platform “leader” as the vehicle variant of a given platform that has the highest level of observed mass reduction present in the analysis fleet. If there is a tie, the CAFE Model begins mass reduction technology on the vehicle with the highest sales volume in MY 2020. If there remains a tie, the model begins by choosing the vehicle with the highest manufacturer suggested retail price (MSRP) in MY 2020. As the model applies technologies, it effectively levels up all variants on a platform to the highest level of mass reduction technology on the platform. For example, if the platform leader model is already at MR3 in MY 2020, and a “follower” platform model starts at MR0 in MY 2020, the follower platform model will get MR3 at its next redesign, assuming no further mass reduction technology is applied to the leader model before the follower model’s next redesign.

In addition to the platform-sharing logic employed in the model, NHTSA applies phase-in caps for MR5 and MR6 (15 percent and 20 percent reduction of a vehicle’s curb weight, respectively), based on the current state of mass reduction technology. As discussed above, for nearly every type of vehicle, a manufacturer’s strategy to achieve mass reduction consistent with MR5 and MR6 will require extensive use of carbon fiber technologies in the vehicles’ primary structures. For example, one way of using carbon fiber

⁴²⁹ Arconic, Docket No. NHTSA–2021–0053–1560, at p. 1.

⁴³⁰ ACC, Docket No. NHTSA–2021–0053–1564, at p. 5.

⁴³¹ *Id.*

technology to achieve MR6 is to develop a carbon fiber monocoque structure.⁴³²

High CAFE stringency levels will push the CAFE Model to select compliance pathways that include these higher levels of mass reduction for vehicles produced in the mid and high hundreds of thousands of vehicles per year. NHTSA assumes, based on material costs and availability, that achieving MR6 levels of mass reduction will cost over ten thousand dollars per car. The cost of achieving MR6 in the CAFE Model is consistent with our understanding of the real-world costs to produce a carbon fiber monocoque structure.⁴³³ Therefore, application of such technology to high volume vehicles is unrealistic today and will, with certainty, remain so for the next several years.

The CAFE Model applies technologies to vehicles that provide a cost-effective pathway to compliance. In some cases, the direct manufacturing cost, indirect costs, and applied learning factor do not capture all the considerations that make a technology more or less costly for manufacturers to apply in the real world. For example, there are direct labor, R&D overhead, manufacturing overhead and tooling costs. Due to the complexities of manufacturing composite components, many of these

are more expensive for manufacturing carbon fiber components than for manufacturing metal components. Next, as of yet, no one has found an effective way to recycle carbon fiber composites, which means there saving money through re-using material is a challenge. In addition, R&D overhead will also increase because of the knowledge base for composite materials in automotive applications is simply not as deep as it is for steel and aluminum.

ACC commented on this characterization of potential costs for carbon fiber technology, using it as an example of where, as discussed above, they believed the NPRM could be construed as NHTSA discouraging the use of carbon fiber composites.⁴³⁴ However, the views stated in the previous paragraph explaining why carbon fiber technologies are not widespread are not indicative of NHTSA discouraging the use of or further development carbon fiber technologies. Rather, they reflect what has actually occurred in the automotive market and views shared by others. In fact, BMW decided that a mixed materials solution is a more financially effective way to reduce mass and will not build a wholly carbon fiber composite successor to the i3.^{435 436 437 438 439}

Indeed, the intrinsic anisotropic mechanical properties of composite materials compared to the isotropic properties of metals complicates the design process. Added testing of these novel anisotropic structures and their associated costs will be necessary for decades. Adding up all these contributing costs, the price tag for a passenger car or truck monocoque would likely be multiple tens of thousands of dollars per vehicle. This would be significantly more expensive than transitioning to hybrid or fully electric powertrains and potentially less effective at achieving CAFE compliance.

In addition, the CAFE Model does not currently enable direct accounting for the stranded capital associated with a transition away from stamped sheet

metal construction to molded composite materials construction. For decades, or in some cases half-centuries, car manufacturers have invested billions of dollars in capital for equipment that supports the industry's sheet metal forming paradigm. A paradigm change to tooling and equipment developed to support molding carbon fiber panels and monocoque chassis structures would leave that capital stranded in equipment that would be rendered obsolete. Doing this is possible, but the financial ramifications are not currently reflected in the CAFE Model for MR5 and MR6 compliance pathways.

Financial matters aside, carbon fiber technology and how it is best used to produce light-weight primary automotive structures is far from mature. In fact, no car company knows for sure the best way to use carbon fiber to make a passenger car's primary structure. Using this technology in passenger cars is far more complex than using it in racing cars where passenger egress, longevity, corrosion protection, crash protection, etc. are lower on the list of priorities for the design team. BMW may be the one manufacturer most able accurately opine on the viability of carbon fiber technology for primary structure on high-volume passenger cars, and even it decided to use a mixed materials solution for their next generation of EVs (the iX and i4) after the i3, thus eschewing a wholly carbon fiber monocoque structure.

Another factor limiting the application of carbon fiber technology to mass volume passenger vehicles is indeed the availability of dry carbon fibers. There is high global demand from a variety of industries for a limited supply of carbon fibers. Aerospace, military/defense, and industrial applications demand most of the carbon fiber currently produced. Today, only roughly 10 percent of the global dry fiber supply goes to the automotive industry, which translates to the global supply base only being able to support approximately 80,000 cars.⁴⁴⁰

To account for these cost and production considerations, including the limited global supply of dry carbon fiber, NHTSA applied phase-in caps that limited the number of vehicles that can achieve MR5 and M6 levels of mass reduction in the CAFE Model. NHTSA applied a phase-in cap for MR5 level technology so that 75 percent of the vehicle fleet starting in 2020 could employ the technology, and the technology could be applied to 100

⁴³² A monocoque structure is one where the outer most skins support the primary loads of the vehicle. For example, they do not have separate non-load bearing aero surfaces. All of the vehicle's primary loads are supported by the monocoque. In the most structurally efficient automotive versions, the monocoque is made from multiple well-consolidated plies of carbon fiber infused with resin. Such structures would likely require a few hundred kilograms of carbon fiber for most passenger vehicles.

⁴³³ In simplest terms, the cost to produce a component made from carbon fiber composite materials is the sum of the cost of dry carbon fiber, resin, amortized tooling, direct labor, and factor overhead. A BMW i3 monocoque contains between 100 and 150 kg of carbon fiber composite material depending on source (see article on https://www.marklines.com/en/report_all/rep1419_201506, (accessed: Feb. 11, 2022). "Recent Trends in CFRP Development: Increased Usage in European Vehicles, July 2015, and see book: "Lightweight and Sustainable Materials for Automotive Applications," Chapter 8, 2017, CRC Press).

Assuming a very typical 60/40 mix of carbon fiber to resin, and assuming the price of dry carbon fiber is \$20-\$40 per kilogram and the price of resin is \$5-\$10 per kilogram, the cost of direct materials alone in an i3's carbon fiber monocoque is already approaching \$4,200. Adding direct labor, factory overhead (which scales with cycle time) and the amortized cost of tooling can easily bring the cost for components made from composite materials in the i3 to a higher level. Note that the BMW i3 is on the small end of the size spectrum in the 2020 fleet and these costs would increase faster than proportional to vehicle footprint because of the mass compounding effect. Therefore, the cost of a monocoque for a large sedan (the current BMW 7-series has a foot-print that is 30 percent higher than that of the i3) could easily cost over ten thousand dollars.

⁴³⁴ ACC, at p. 5.

⁴³⁵ Brosius, Dale, "Carbon Fiber in Automotive: At a Dead End?" Composites World, December 20, 2021.

⁴³⁶ Sloan, Jeff, "AutoComposites and the Myth of \$5/lb. Carbon Fiber," Composites World, February 24, 2017.

⁴³⁷ Taylor, Edward and Sage, Alexandria, "BMW Limits Lightweight Carbon Fibre Use to Juice Profits," Reuters, October 2016.

⁴³⁸ Bunkley, Nick, "BMW Limits Carbon Fiber Use to Protect Profits," Autonews Gasgoo, October 31, 2016.

⁴³⁹ Schlosser, Andreas, Coskun Baban, Samith, and Siedel Phillipp, "After the Hype: Where is the Carbon Car?" Arthur D. Little, January 2019.

⁴⁴⁰ J. Sloan, "Carbon Fiber Suppliers Gear up for Next Generation Growth," compositesworld.com, February 11, 2020.

percent of the fleet by MY 2022. NHTSA also applied a phase-in cap for MR6 technology so that five percent of the vehicle fleet starting in MY 2020 could employ the technology, and the technology could be applied to 10 percent of the fleet by MY 2025.

To develop these phase-in caps, NHTSA chose a 40,000-unit threshold for both MR5 and MR6 technology (80,000 units total), because it roughly reflects the number of BMW i3 cars produced per year worldwide.⁴⁴¹ As discussed above, the BMW i3 is the only high-volume vehicle currently produced with a primary structure mostly made from carbon fiber (except the skateboard, which is aluminum). Because mass reduction is applied at the platform level (meaning that every car of a given platform would receive the technology, not just special low volume versions of that platform), only platforms representing 40,000 vehicles or less are eligible to apply MR5 and MR6 toward CAFE compliance. Platforms representing high volume sales, like a Chevrolet Traverse, for example, where hundreds of thousands are sold per year, are therefore blocked from access to MR5 and MR6 technology. There are no phase in caps for mass reduction levels MR1, MR2, MR3 or MR4.

In addition to determining that the caps were reasonable based on current global carbon fiber production, NHTSA determined that the MR5 phase-in cap is consistent with the NHTSA light-weighting study that found that a 15 percent curb weight reduction for the fleet is possible within the rulemaking timeframe.⁴⁴²

These phase-in caps appropriately function as a proxy for the cost and complexity currently required (and that likely will continue to be required until manufacturing processes evolve) to produce carbon fiber components. Again, MR6 technology in this analysis reflects the use of a significant share of carbon fiber content, as seen through the BMW i3 and Alfa Romeo 4c as discussed above.

⁴⁴¹ However, even this number is optimistic because only a small fraction of i3 cars are sold in the U.S. market, and combining MR5 and MR6 allocations equates to 80k vehicles, not 40k. Regardless, if the auto industry ever seriously committed to using carbon fiber in mainstream high-volume vehicles, competition with the other industries would rapidly result in a dramatic increase in price for dry fiber. This would further stymie the deployment of this technology in the automotive industry.

⁴⁴² Singh, Harry. (2012, August). Mass Reduction for Light-Duty Vehicles for Model Years 2017–2025. (Report No. NHTSA HS 811 666). Program Reference: NHTSA Contract DTNH22–11–C–00193. Contract Prime: Electricore, Inc, at 356, Figure 397.

Given the uncertainty and fluid nature of knowledge around higher levels of mass reduction technology, we welcomed comments on how to most cost effectively use carbon fiber technology in high-volume passenger cars. We also stated that financial implementation estimates for this technology are equally as welcome.

NHTSA received comment involving the ability of auto industry suppliers to procure dry carbon fiber materials in quantities consistent with supplying high-volume platforms. Commenters suggested that the industry that produces dry carbon fiber could readily ramp-up fiber production at a rate fast enough to accommodate the demands of multiple high volume automotive platforms such as the Chevrolet Traverse or Volvo XC90, all within the time frame in which this rule applies.⁴⁴³ Commenters did not mention specific achievable production volumes or detail a production volume trajectory as a function of time. In addition, ACC commented that it was misleading for NHTSA to state that only roughly 10 percent of the global dry fiber supply goes to the automotive industry, that 10 percent would only be enough for roughly 70,000 vehicles and that producers of dry carbon fiber would not scale their output to support high volume production automotive programs. Based on available literature, engineering judgment and the composition of the current fleet, we continue to believe that MR5 or MR6 will not be achievable for large volume platforms in the rulemaking timeframe.⁴⁴⁴ Sources in the literature indicate that if only three mass volume auto makers used 8–9 kg of carbon fiber (which would not meet MR5 or MR6 levels) in each of their vehicles, the carbon fiber industry would need to double its output. Using only 8–9 kg of carbon fiber per vehicle will never enable mass reduction consistent with MR5 or MR6. The amount of carbon fiber required for this would require at least an order of magnitude more than 8–9 kg. Fiber producers cannot double their output in the rulemaking timeframe let alone increase it by twenty-fold within the same timeframe.⁴⁴⁵

In addition, since publication of the NPRM, BMW stopped producing its i3 vehicle, the only mass-volume vehicle built with nearly full carbon fiber

⁴⁴³ ACC, at p. 5.

⁴⁴⁴ Bill, Bregar, “Prices Keep Carbon Fiber from Mass Adoption,” *Plastic News*, August 5, 2014.

⁴⁴⁵ “How to Turn Pitch into Carbon Fiber for Automotive Applications,” <https://www.azom.com/article.aspx?ArticleID=19200> (accessed: Feb. 11, 2022).

construction. The i3 was replaced with a vehicle containing only a small fraction of the amount carbon fiber composite materials as its predecessor. BMW decided a multi-materials solution was more cost effective.^{446 447} Currently, the few vehicles that continue to use carbon fiber do so in only small fractions or they are not mass-market vehicles.⁴⁴⁸ We are not currently aware of any high-volume cars planned for the near future with nearly full carbon fiber construction. If that remains the case, there is no incentive to dramatically boost production of dry carbon fiber to support the auto industry.

There may be some emerging methods to provide a lower cost pathway to MR6, like selectively applying high-modulus carbon fiber tapes to lower cost structures primarily made from fiberglass composites.⁴⁴⁹ Although these methods may reduce the cost of direct materials, they do not alleviate slow production cycle times and the costs associated with them.

The analysis herein uses the 2020 fleet to evaluate the level of mass reduction (MR0–MR6) achieved by individual vehicle platforms. In total, a little more than 25,000 vehicles of a fleet containing roughly 16 million vehicles achieved MR5 and MR6. It is expected that achieving MR5 will require at least some carbon fiber technology and achieving MR6 will require nearly full carbon fiber construction. Of the 25,000 vehicles, about 5,000 vehicles have nearly full carbon fiber construction. These vehicles are produced by BMW (the i3 and i8), the VW Group (Bugatti and Lamborghini) and few others that are not big enough to be included in the 2020 fleet. Noteworthy is that there are service vans in the fleet that achieve the highest MR levels, but only for the reason that they have large footprints (wheelbase times average track) and do not include interior trim and luxury items. Given this small representation of vehicles with nearly full carbon fiber construction, and current trends in

⁴⁴⁶ Taylor, Edward and Sage, Alexandria, “BMW Limits Lightweight Carbon Fibre Use to Juice Profits,” *Reuters*, October 2016.

⁴⁴⁷ Bunkley, Nick, “BMW Limits Carbon Fiber Use to Protect Profits,” *Autonews Gasgoo*, October 31, 2016.

⁴⁴⁸ See, e.g., the BMW iX and i4, and some Lamborghini vehicles.

⁴⁴⁹ By strategic application of carbon fiber in areas of highest stress in a given structure, it is often possible to achieve sufficient structural performance at a lower cost. However, this strategy does not solve the aforementioned issues surrounding the high costs associated with the relatively long production cycle times of composite materials composites.

automotive carbon fiber application, discussed above, we do not believe that multiple large-volume platforms would be able to reach MR6 in the rulemaking timeframe.

We will continue to monitor carbon fiber investments from the automotive sector, whether for full carbon fiber construction bodies or carbon fiber parts, and on the implications of such investments for automotive application carbon fiber demand, capacity, and supply. Based on these observations, however, we declined to update any of our mass reduction adoption features for this final rule.

(d) Mass Reduction Effectiveness Modeling

As discussed in Section III.C.4, Argonne developed a database of vehicle attributes and characteristics for each vehicle technology class that included over 100 different attributes. Some examples from these 100 attributes include frontal area, drag coefficient, fuel tank weight, transmission housing weight, transmission clutch weight, hybrid vehicle components, and weights for components that comprise engines and electric machines, tire rolling resistance, transmission gear ratios, and final drive ratio. Argonne used these attributes to “build” each vehicle that it used for the effectiveness modeling and simulation. Important for precisely estimating the effectiveness of different levels of mass reduction is an accurate list of initial component weights that make up each vehicle subsystem, from which Autonomie considered potential mass reduction opportunities.

As stated above, NHTSA uses glider weight, or the vehicle curb weight minus the powertrain weight, to determine the potential opportunities for weight reduction irrespective of the type of powertrain.⁴⁵⁰ This is because weight reduction can vary depending on the type of powertrain. For example, an 8-speed transmission may weigh more than a 6-speed transmission, and a basic engine without variable valve timing may weigh more than an advanced engine with variable valve timing. Autonomie simulations account for the weight of the powertrain system inherently as part of the analysis, and the powertrain mass accounting is separate from the application and accounting for mass reduction technology levels that are applied to the glider in the simulations. Similarly,

⁴⁵⁰ Depending on the powertrain combination, the total curb weight of the vehicle includes glider, engine, transmission and/or battery pack and motor(s).

Autonomie also accounts for battery and motor mass used in hybrid and electric vehicles separately. This secondary mass reduction is discussed further below.

Accordingly, in the Autonomie simulations, mass reduction technology is simulated as a percentage of mass removed from the specific subsystems that make up the glider, as defined for that set of simulations (including the non-powertrain secondary mass systems such as the brake system). For the purposes of determining a reasonable percentage for the glider, NHTSA in consultation with Argonne examined glider weight data available in the A2Mac1 database,⁴⁵¹ in addition to the NHTSA MY 2014 Chevrolet Silverado light-weighting study (discussed further below). Based on these studies, NHTSA assumes that the glider weight comprised 71 percent of the vehicle curb weight. TSD Chapter 3.4.4 includes a detailed breakdown of the components that NHTSA considered to arrive at the conclusion that a glider, on average, represents 71 percent of a vehicle’s curb weight.

Any mass reduction due to powertrain improvements is accounted for separately from glider mass reduction. Autonomie considers several components for powertrain mass reduction, including engine downsizing, and transmission, fuel tank, exhaust systems, and cooling system light-weighting.

The 2015 NAS Report suggested an engine downsizing opportunity exists when the glider mass is light-weighted by at least 10 percent. The 2015 NAS Report also suggested that 10 percent light-weighting of the glider mass alone would boost fuel economy by 3 percent and any engine downsizing following the 10 percent glider mass reduction would provide an additional 3 percent increase in fuel economy.⁴⁵² The 2011 Honda Accord and 2014 Chevrolet Silverado light-weighting studies applied engine downsizing (for some vehicle types but not all) when the glider weight was reduced by 10 percent. Accordingly, this analysis limited engine resizing to several specific incremental technology steps as in the 2018 NPRM and 2020 final rule; important for this discussion, engines in the analysis were only resized when mass reduction of 10 percent or greater

⁴⁵¹ A2Mac1: Automotive Benchmarking, <https://a2mac1.com>.

⁴⁵² 2015 NAS Report. National Research Council. 2015. Cost, Effectiveness, and Deployment of Fuel Economy Technologies for Light-Duty Vehicles. Washington, DC—The National Academies Press. <https://doi.org/10.17226/21744>, (accessed: Feb. 11, 2022).

was applied to the glider mass, or when one powertrain architecture was replaced with another architecture.

Specifically, we allow engine resizing upon adoption of 7.1, 10.7, 14.2, and 20 percent curb weight reduction, but not at 3.6 and 5.3 percent.⁴⁵³ Resizing is also allowed upon changes in powertrain type or the inheritance of a powertrain from another vehicle in the same platform. The increments of these higher levels of mass reduction, or complete powertrain changes, more appropriately match the typical engine displacement increments that are available in a manufacturer’s engine portfolio.

Argonne performed a regression analysis of engine peak power versus weight for a previous analysis based on attribute data taken from the A2Mac1 benchmarking database, to account for the difference in weight for different engine types. For example, to account for weight of different engine sizes like 4-cylinder versus 8-cylinder, Argonne developed a relationship curve between peak power and engine weight based on the A2Mac1 benchmarking data. We use this relationship to estimate mass for all engine types regardless of technology type (e.g., variable valve lift and direct injection). NHTSA applies weight associated with changes in engine technology by using this linear relationship between engine power and engine weight from the A2Mac1 benchmarking database. When a vehicle in the analysis fleet with an 8-cylinder engine adopts a more fuel-efficient 6-cylinder engine, the total vehicle weight reflects the updated engine weight with two less cylinders based on the peak power versus engine weight relationship.

When Autonomie selects a powertrain combination for a light-weighted glider, the engine and transmission are selected such that there is no degradation in the performance of the vehicle relative to the baseline vehicle. The resulting curb weight is a combination of the mass reduced glider with the resized and potentially new engine and transmission. This methodology also helps in accurately accounting for the cost of the glider and cost of the engine and transmission in the CAFE Model.

Secondary mass reduction is possible from some of the components in the glider after mass reduction is applied to the primary subsystems (body, chassis, and interior). Similarly, engine

⁴⁵³ These curb weight reductions equate to the following levels of mass reduction as defined in the analysis: MR3, MR4, MR5 and MR6, but not MR1 and MR2; additional discussion of engine resizing for mass reduction can be found in Section III.C.4 and TSD Chapter 2.4.

downsizing and powertrain secondary mass reduction is possible after certain level of mass reduction is incorporated in the glider. For the analysis, the agencies include both primary mass reduction, and when there is sufficient primary mass reduction, additional secondary mass reduction. The Autonomie simulations account for the aggregate of both primary and secondary glider mass reduction, and separately for powertrain mass.

Note that secondary mass reduction is integrated into the mass reduction cost curves. Specifically, the NHTSA studies, upon which the cost curves depend, first generated costs for light-weighting the vehicle body, chassis, interior, and other primary components, and then calculated costs for light-weighting secondary components. Accordingly, the cost curves reflect that, for example, secondary mass reduction for the brake system is only applied after there has been sufficient primary mass reduction to allow the smaller brake system to provide safe braking

performance and to maintain mechanical functionality.

NHTSA enhances the accuracy of estimated engine weights by using two curves to represent separately naturally aspirated engine designs and turbocharged engine designs.⁴⁵⁴ This achieves two benefits. First, small naturally aspirated 4-cylinder engines that adopt turbocharging technology reflects the increased weight of associated components like ducting, clamps, the turbocharger itself, a charged air cooler, wiring, fasteners, and a modified exhaust manifold. Second, larger cylinder count engines like naturally aspirated 8-cylinder and 6-cylinder engines that adopt turbocharging and downsizing technologies have lower weight due to having fewer engine cylinders. For this analysis, a naturally aspirated 8-cylinder engine that adopts turbocharging technology and is downsized to a 6-cylinder turbocharged engine appropriately reflects the added

⁴⁵⁴ See Autonomie model documentation, Chapter 5.2.9, Engine Weight Determination.

weight of the turbocharging components, and the lower weight of fewer cylinders.

The range of effectiveness values for the mass reduction technologies, for all ten vehicle technology classes are shown in Figure III–14. In the graph, the box shows the inner quartile range (IQR) of the effectiveness values and whiskers extend out 1.5 x IQR. The NHTSAs outside of the whiskers show a few values outside these ranges. As discussed earlier, Autonomie simulates all possible combinations of technologies for fuel consumption improvements. For a few technology combinations mass reduction has minimal impact on effectiveness on the regulatory 2-cycle test. For example, if an engine is operating in an efficient region of the fuel map on the 2-cycle test further reduction of mass may have smaller improvement on the regulatory cycles. Figure III–14 shows the range improvements based on the full range of other technology combinations considered in the analysis.

BILLING CODE 4910–59–P

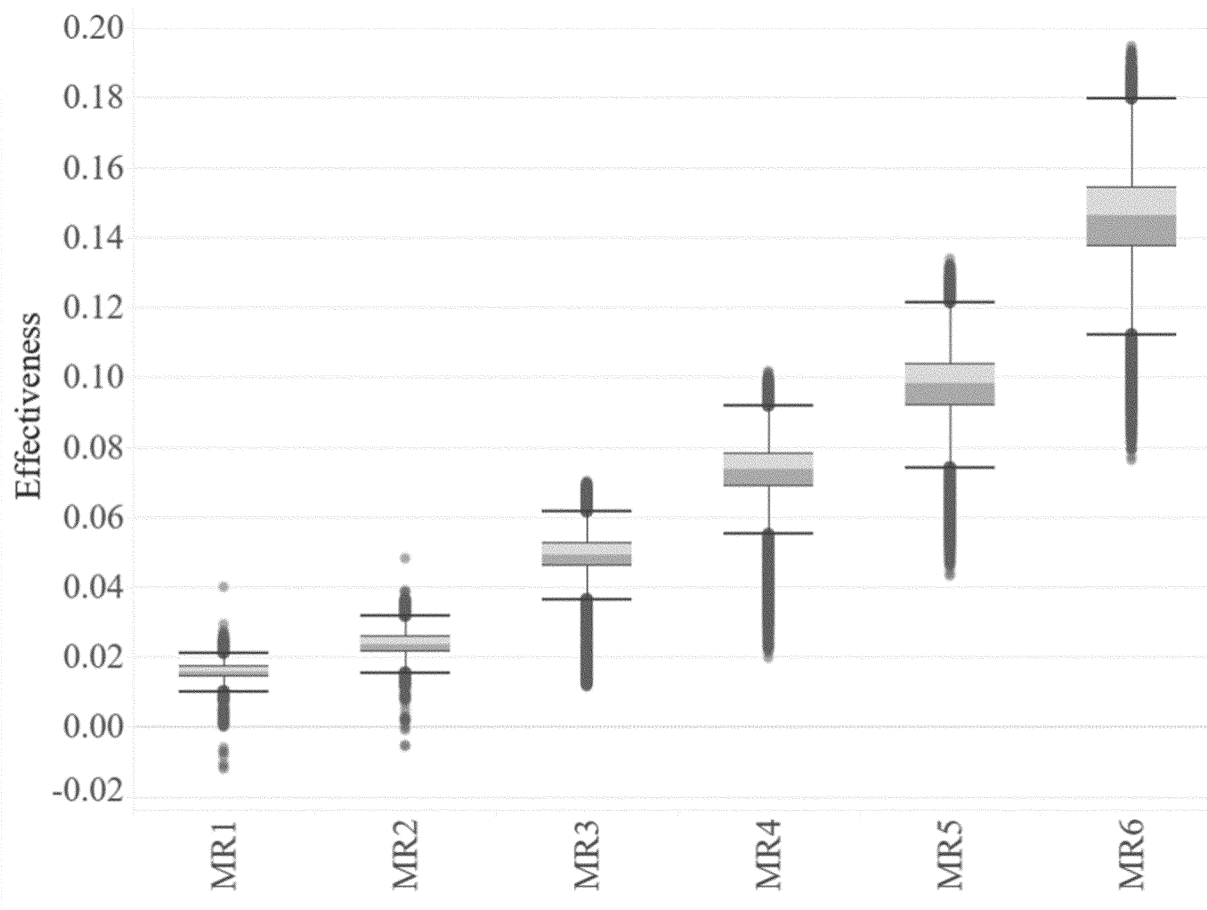

Figure III-14 – Mass Reduction Technologies Effectiveness Values for all the Vehicle Technology Classes

(e) Mass Reduction Costs

The CAFE Model analysis handles mass reduction technology costs differently than all other technology costs. Mass reduction costs are calculated as an average cost per pound over the baseline (MR0) for a vehicle's glider weight. While the definitions of glider may vary, NHTSA uses the same dollar per pound of curb weight to develop costs for different glider definitions. In translating these values, NHTSA takes care to track units (\$/kg vs. \$/lb.) and the reference for percentage improvements (glider vs. curb weight).

NHTSA calculates the cost of mass reduction on a glider weight basis so that the weight of each powertrain configuration can be directly and separately accounted for. This approach provides the true cost of mass reduction without conflating the mass change and costs associated with downsizing a powertrain or adding additional advanced powertrain technologies. Hence, the mass reduction costs in this final rule reflect the cost of mass reduction in the glider and do not

include the mass reduction associated with engine downsizing. The mass reduction and costs associated with engine downsizing are accounted for separately.

A second reason for using glider share instead of curb weight is that it affects the absolute amount of curb weight reduction applied, and therefore cost per pound for the mass reduction changes with the change in the glider share. The cost for removing 20 percent of the glider weight when the glider represents 75 percent of a vehicle's curb weight is not the same as the cost for removing 20 percent of the glider weight when the glider represents 50 percent of the vehicle's curb weight. For example, the glider share of 79 percent of a 3,000-pound curb weight vehicle is 2,370 lbs., while the glider share of 50 percent of a 3,000-pound curb weight vehicle is 1,500 lbs., and the glider share of 71 percent of a 3,000-pound curb weight vehicle is 2,130 lbs. The mass change associated with 20 percent mass reduction is 474 lbs. for 79 percent glider share ($= [3,000 \text{ lbs.} \times 79\% \times 20\%]$), 300 lbs. for 50 percent glider

share ($= [3,000 \text{ lbs.} \times 50\% \times 20\%]$), and 426 lbs. for 71 percent glider share ($= [3,000 \text{ lbs.} \times 71\% \times 20\%]$). The mass reduction cost studies that NHTSA relies on to develop mass reduction costs for this analysis show that the cost for mass reduction varies with the amount of mass reduction. Therefore, for a fixed glider mass reduction percentage, different glider share assumptions will have different costs.

NHTSA considered several sources to develop the mass reduction technology cost curves. Several mass reduction studies have used either a mid-size passenger car or a full-size pickup truck as an exemplar vehicle to demonstrate the technical and cost feasibility of mass reduction. While the findings of these studies may not apply directly to different vehicle classes, the cost estimates derived for the mass reduction technologies identified in these studies can be useful for formulating general estimates of costs. As discussed further below, the mass reduction cost curves developed for this analysis are based on two light-weighting studies, and NHTSA also updated the curves based

on more recent studies to better account for the cost of carbon fiber needed for the highest levels of mass reduction technology. The two studies used for MR1 through MR4 costs included the teardown of a MY 2011 Honda Accord and a MY 2014 Chevrolet Silverado pickup truck, and the carbon fiber costs required for MR5 and MR6 were updated based on the 2021 NAS Report.⁴⁵⁵

Both teardown studies are structured to derive the estimated cost for each of the mass reduction technology levels. NHTSA relies on the results of those studies because they considered an extensive range of material types, material gauge, and component redesign while taking into account real world constraints such as manufacturing and assembly methods and complexity, platform-sharing, and maintaining vehicle utility, functionality and attributes, including safety, performance, payload capacity, towing capacity, handling, NVH, and other characteristics. In addition, NHTSA believes that the baseline vehicles and mass reduction technologies assessed in the studies are still reasonably representative of the technologies that may be applied to vehicles in the MY 2020 analysis fleet to achieve up to MR4 level mass reduction in the rulemaking timeframe. NHTSA adjusted the cost estimates derived from the two studies to reflect the assumption that a vehicle's

glider weight consisted of 71 percent of the vehicle's curb weight, and mass reduction as it pertains to achieving MR0–MR6 levels would only come from the glider.

As discussed above, achieving the highest levels of mass reduction often necessitates extensive use of advanced materials like higher grades of aluminum, magnesium, or carbon fiber. We provided a survey of information available regarding carbon fiber costs based on the Honda Accord and Chevrolet Silverado teardown studies. In the Honda Accord study, the estimated cost of carbon fiber was \$5.37/kg, and the cost of carbon fiber used in the Chevy Silverado study was \$15.50/kg. The \$15.50 estimate closely matched the cost estimates from a BMW i3 teardown analysis,⁴⁵⁶ the cost figures provided by Oak Ridge National Laboratory for a study from the IACMI Composites Institute,⁴⁵⁷ and from a Ducker Worldwide presentation at the CAR Management Briefing Seminar.⁴⁵⁸

However, for this analysis, NHTSA relies on the cost estimates for carbon fiber construction that NAS detailed in the 2021 Assessment of Technologies for Improving Fuel Economy of Light-Duty Vehicles—Phase 3 recently completed by NAS.⁴⁵⁹ The study indicates that the sum of direct materials costs plus manufacturing costs for carbon fiber composite automotive components is \$25.97 per pound in high

volume production. In order to use this cost in the CAFE Model it must be put in terms of dollars per pound saved. Using an average vehicle curb weight of 4000 lbs., a 71 percent glider share and the percent mass savings associated with MR5 and MR6, it is possible to calculate the number of pounds to be removed to attain MR5 and MR6. Also taken from the NAS study is the assertion that carbon fiber substitution for steel in an automotive component results in a 50 percent mass reduction. Combining all this together, carbon fiber technology offers weight savings at \$24.60 per pound saved. This dollar per pound savings figure must also be converted to a retail price equivalent (RPE) to account for various commercial costs associated with all automotive components. This is accomplished by multiplying \$24.60 by the factor 1.5. This brings the cost per pound saved for using carbon fiber to \$36.90 per pound saved.⁴⁶⁰ The analysis uses this cost for achieving MR5 and MR6.

Table III–23 and Table III–24 show the cost values (in dollars per pound) used in the CAFE Model with MR1–4 costs based on the cost curves developed from the MY 2011 Honda Accord and MY 2014 Chevrolet Silverado studies, and the updated MR5 and MR6 values that account for the updated carbon fiber costs from the 2021 NAS Report. Both tables assume a 71 percent higher glider share.

Table III-23 – Mass Reduction Costs for MY 2020 in CAFE Model for Small Car, Small Car Performance, Medium Car, Medium Car Performance, Small SUV, Small SUV Performance

	PERCENTAGE REDUCTION IN GLIDER WEIGHT	PERCENTAGE REDUCTION IN CURB WEIGHT	COST OF MASS REDUCTION (\$/LBS)
MR0	0.00%	0.00%	0.00
MR1	5.00%	3.55%	0.46
MR2	7.50%	5.33%	0.86
MR3	10.00%	7.10%	1.22
MR4	15.00%	10.65%	1.59
MR5	20.00%	14.20%	36.90
MR6	28.00%	20%	36.90

⁴⁵⁵ This analysis applied the cost estimates per pound derived from passenger cars to all passenger car segments, and the cost estimates per pound derived from full-size pickup trucks to all light-duty truck and SUV segments. The cost estimates per pound for carbon fiber (MR5 and MR6) were the same for all segments.

⁴⁵⁶ Singh, Harry, FSV Body Structure Comparison with 2014 BMW i3, Munro and Associates for World Auto Steel (June 3, 2015).

⁴⁵⁷ IACMI Baseline Cost and Energy Metrics (March 2017), available at <https://iacmi.org/wp-content/uploads/2016/10/Dale-Brosius-IACMI-1.pdf> (accessed Feb. 11, 2022).

⁴⁵⁸ Ducker Worldwide, The Road Ahead—Automotive Materials (2016), <https://societyof>

automotiveanalysts.wildapricot.org/resources/Pictures/SAA%20Sumit%20slides%20for%20Abey%20Abraham%20of%20Ducker.pdf, (accessed: Feb. 11, 2022).

⁴⁵⁹ 2021 NAS Report, at p. 219.

⁴⁶⁰ See MR5 and MR6 CFRP Cost Increase Calculator.xlsx in the docket for this action.

Table III-24 – Mass Reduction Costs for MY 2020 in CAFE Model for Medium SUV, Medium SUV Performance, Pickup, Pickup HT

	PERCENTAGE REDUCTION IN GLIDER WEIGHT	PERCENTAGE REDUCTION IN CURB WEIGHT	COST OF MASS REDUCTION (\$/LBS)
MR0	0	0.00%	0.00
MR1	5.00%	3.55%	0.30
MR2	7.50%	5.33%	0.70
MR3	10.00%	7.10%	1.25
MR4	15.00%	10.65%	1.70
MR5	20.00%	14.20%	36.90
MR6	27.25%	19.35%	36.90

There is a dramatic increase in cost going from MR4 to MR5 and MR6 for all classes of vehicles. However, while the increase in cost going from MR4 to MR5 and MR6 is dramatic, the MY 2011 Honda Accord study, the MY 2014 Chevrolet Silverado study, and the 2021

NAS Report all included a steep increase to achieve the highest levels of mass reduction technology.

Table III-25 provides an example of mass reduction costs in 2018\$ over select model years for the medium car and pickup truck technology classes as

a dollar per pound value. The table shows how the \$/lb. value for each mass reduction level decreases over time because of cost learning. For a full list of the \$/lb. mass reduction costs used in the analysis across all model years, see the Technologies file.

Table III-25 – Examples of the \$/lb. Mass Reduction Costs in 2018\$ for Medium Car and Pickup Truck Vehicle Classes

TECHNOLOGY	MEDIUM CAR COSTS (2018\$)/LBS			PICKUP COSTS (2018\$)/LBS		
	MY 2020	MY 2025	MY 2030	MY 2020	MY 2025	MY 2030
MR0	0.00	0.00	0.00	0.00	0.00	0.00
MR1	0.46	0.42	0.39	0.30	0.27	0.25
MR2	0.86	0.78	0.73	0.70	0.63	0.59
MR3	1.22	1.11	1.03	1.25	1.13	1.06
MR4	1.59	1.34	1.21	1.70	1.44	1.30
MR5	36.90	31.44	26.93	36.90	31.44	26.93
MR6	36.90	31.44	26.93	36.90	31.44	26.93

BILLING CODE 4910-59-C

NHTSA received comment from the ACC regarding the costs used in the analysis for carbon fiber technology and how new precursors will soon be available with high potential to reduce the cost of dry carbon fibers.⁴⁶¹ These precursor materials include, lignin, mesophase pitch and textile-grade polyacrylonitrile (TG-PAN). Commenters specifically referenced research conducted into these precursor materials conducted at the Carbon Fiber Technology Facility at Oak Ridge National Laboratory.

Indeed, a factor that dominates the price of dry carbon fibers is the precursor materials from which it is made. Dry carbon fibers that are used in the mainstream automotive industry today, like those used by BMW,⁴⁶² are derived from high-molecular weight PAN fibers. The high molecular weight of these materials not only makes the

material expensive, but it makes it more expensive to convert to carbon fiber because it takes much longer to pyrolyze the fibers. However, the result is a consistently stiff and incredibly high-strength fiber. Prices today for traditional 3K tow (tow refers to the width of a strand) PAN-based carbon fiber fall within the \$20/kg to \$40/kg range.⁴⁶³ These price levels are consistent with NHTSA's understanding and with the recent 2021 NAS Report.⁴⁶⁵

The commenters mentioned several other advancements in carbon fiber technologies that are under development; however, we do not believe these materials will be available for use in the rulemaking timeframe. Lignin, which is an organic substance found in the cells of plants, has great potential to achieve affordable carbon fibers and could potentially be a lower-

cost alternative to PAN.⁴⁶⁶ While lignin is renewable, recyclable, sustainable, and cost effective, there are stiffness and cost issues with lignin and research into lignin-based carbon fiber has significantly slowed.⁴⁶⁸ Similarly, mesophase pitch and TG-PAN are encouraging mass reduction technologies;⁴⁶⁹ however, based on

⁴⁶⁶ Azarova, M.T., Semakina, N.S., Konkin, A.A., Tikhomirova, M.V. "Carbon Fiber Based on Meso-Phase-Pitches," *Fiber Chemistry*, 1982, pp. 103–110.

⁴⁶⁷ Kadla, J.F, et al., "Lignin-Based Carbon Fibers for Composite Applications," *Carbon*, Vol. 20, 2002, pp. 2913–2920.

⁴⁶⁸ For example, one issue with lignin-based carbon fiber is that the density specific stiffness of fully pyrolyzed lignin-based carbon fiber laminated in an epoxy matrix (which is a materials property that often dominates mass reduction potential) is barely competitive with that of steel. Yet steel costs about \$1/kg–\$3/kg. Furthermore, because the absolute stiffness of lignin-based carbon fiber composite material is low, a component made with lignin-based carbon fiber composite material will require more packaging space than a steel component to achieve equivalent component level stiffness.

⁴⁶⁹ Mesophase pitch is made from coal which is plentiful and therefore low cost, and the material

Continued

⁴⁶¹ ACC, at p. 5.

⁴⁶² J. Sloan, "Carbon Fiber Suppliers Gear up for Next Generation Growth," *compositesworld.com*, February 11, 2020.

⁴⁶³ Schlosser, Andreas, Coskun Baban, Samith, and Siedel Phillipp, "After the Hype: Where is the Carbon Car?" Arthur D. Little, January 2019.

⁴⁶⁴ 2021 NAS Report, at pp. 218, 219, 419.

⁴⁶⁵ Id.

their developmental nature we do not believe they will be available for commercial application in this rulemaking timeframe. Therefore, we do not believe that the lower costs cited in the ORNL studies are representative of the costs to industry for carbon fiber technology in the rulemaking timeframe. We will continue to closely monitor these new fiber precursor materials and how they may enable low-cost carbon fiber technology with competitive mechanical properties.

Aside from precursor materials issues, how dry carbon fibers are processed into usable carbon fiber composite components is also an important cost driver that we do not believe is represented in the lower cited cost estimates. As an example, the carbon fiber composite parts used on the BMW i3 are manufactured with cycle times between five and ten minutes,⁴⁷⁰ while precise and accurate metallic parts are produced in seconds.

Again, we will continue to monitor composite materials processing technology advances and make cost adjustments in future analysis to reflect advances in this field.

Aerodynamics

The energy required to overcome aerodynamic drag accounts for a significant portion of the energy consumed by a vehicle and can become the dominant factor for a vehicle's energy consumption at high speeds. Reducing aerodynamic drag can,

has a density specific stiffness better than steel, aluminum, and magnesium. TG-PAN has a molecular weight that is about half that of traditional PAN materials used from making carbon fiber and consequently requires less time to pyrolyze, thus reducing its costs. In addition, textile grade PAN is available in much wider tows ($\geq 50k$) than traditional PAN which means that more material can be converted to carbon fiber in less time.

⁴⁷⁰ Sloan, Jeff, "BMW Leipzig: The Epicenter of i3 Production," Composites World, May 31, 2014.

therefore, be an effective way to reduce fuel consumption and emissions.

Aerodynamic drag is proportional to the frontal area (A) of the vehicle and coefficient of drag (Cd), such that aerodynamic performance is often expressed as the product of the two values, CdA, which is also known as the drag area of a vehicle. The coefficient of drag (Cd) is a dimensionless value that essentially represents the aerodynamic efficiency of the vehicle shape. The frontal area (A) is the cross-sectional area of the vehicle as viewed from the front. It acts with the coefficient of drag as a sort of scaling factor, representing the relative size of the vehicle shape that the coefficient of drag describes. The force imposed by aerodynamic drag increases with the square of vehicle velocity, accounting for the largest contribution to road loads at higher speeds.

Aerodynamic drag reduction can be achieved via two approaches, either by reducing the drag coefficient or reducing vehicle frontal area, with two different categories of technologies, passive and active aerodynamic technologies. Passive aerodynamics refers to aerodynamic attributes that are inherent to the shape and size of the vehicle, including any components of a fixed nature. Active aerodynamics refers to technologies that variably deploy in response to driving conditions. These include technologies such as active grille shutters, active air dams, and active ride height adjustment. It is important to note that manufacturers may employ both passive and active aerodynamic technologies to achieve aerodynamic drag improvements.

The greatest opportunity for improving aerodynamic performance is during a vehicle redesign cycle when the manufacturer can make significant changes to the shape and size of the vehicle. A manufacturer may also make incremental improvements during mid-

cycle vehicle refresh using restyled exterior components and add-on devices. Some examples of potential technologies that a manufacturer could apply during mid-cycle refresh are restyled front and rear fascia, modified front air dams and rear valances, addition of rear deck lips and underbody panels, and low-drag exterior mirrors. While manufacturers may nudge the frontal area of the vehicle during redesigns, large changes in the frontal area are typically not possible without impacting the utility and interior space of the vehicle. Similarly, manufacturers may improve Cd by changing the frontal shape of the vehicle or lowering the height of the vehicle, among other approaches, but the form drag of certain body styles and airflow needs for engine cooling often limit how much manufacturers can improve Cd.

The following sections discuss the four levels of aerodynamic improvements that we consider in the CAFE Model, how we assign baseline aerodynamic technology levels to vehicles in the MY 2020 fleet, the effectiveness improvements for the addition of aerodynamic technologies to vehicles, and the costs for adding that aerodynamic technology.

(a) Aerodynamic Technologies in the CAFE Model

We bin aerodynamic improvements into four levels—5, 10, 15, and 20 percent aerodynamic drag improvement values over a baseline computed for each vehicle body style—which correspond to AERO5, AERO10, AERO15, and AERO20, respectively.

The aerodynamic improvements technology pathway consists of a linear progression, with each level superseding all previous levels, as seen in Figure III-15.

BILLING CODE 4910-59-P

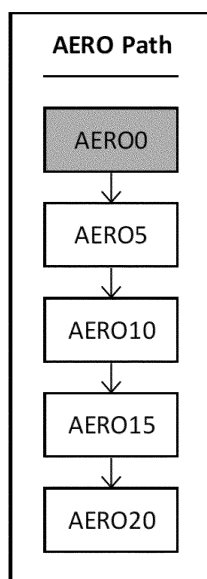

Figure III-15 – Technology Pathway for Levels of Aerodynamic Drag Reduction

While the four levels of aerodynamic improvements are technology-agnostic, we built a pathway to compliance for each level based on aerodynamic data from a National Research Council (NRC) of Canada-sponsored wind tunnel testing program. The program included an extensive review of production vehicles utilizing these technologies, and industry comments.^{471 472} Again, these technology combinations are intended to show a potential way for a manufacturer to achieve each aerodynamic improvement level; however, in the real world,

manufacturers may implement different combinations of aerodynamic technologies to achieve a percentage improvement over their baseline vehicles.

Table III-26 and Table III-27 show the aerodynamic technologies that could be used to achieve 5, 10, 15, and 20 percent improvements in passenger cars, SUVs, and pickup trucks. As discussed further in Section III.D.5.c), the model does not apply AERO20 to pickup trucks, which is why there is no pathway to AERO20 shown in Table III-27. While manufacturers can apply

some aerodynamic improvement technologies across vehicle classes, like active grille shutters (used in the 2015 Chevrolet Colorado),⁴⁷³ we determined that there are limitations that make it infeasible for vehicles with some body styles to achieve a 20 percent reduction in the coefficient of drag from their baseline. This technology path is an example of how a manufacturer could reach each AERO level, but they would not necessarily be required to use the technologies.

⁴⁷¹ Larose, G., Belluz, L., Whittal, I., Belzile, M. et al., "Evaluation of the Aerodynamics of Drag Reduction Technologies for Light-duty Vehicles—a Comprehensive Wind Tunnel Study," SAE Int. J. Passeng. Cars—Mech. Syst. 9(2):772–784, 2016, <https://doi.org/10.4271/2016-01-1613>, (accessed: Feb. 11, 2022).

⁴⁷² Larose, Guy & Belluz, Leanna & Whittal, Ian & Belzile, Marc & Klomp, Ryan & Schmitt, Andreas. (2016). Evaluation of the Aerodynamics of Drag Reduction Technologies for Light-duty Vehicles—a Comprehensive Wind Tunnel Study. SAE International Journal of Passenger Cars—Mechanical Systems. 9. 10.4271/2016-01-1613.

⁴⁷³ Chevrolet Product Information, available at https://media.chevrolet.com/content/media/us/en/chevrolet/vehicles/colorado/2015/_jcr_content/iconrow/textfile/file.res/15-PG-Chevrolet-Colorado-082218.pdf, (accessed: Feb. 11, 2022).

Table III-26 – Combinations of Technologies That Could Achieve Aerodynamic Improvements Used in the Current Analyses for Passenger Cars and SUVs

AERO IMPROVEMENT LEVEL	COMPONENTS	EFFECTIVENESS (%)
AERO5	Front Styling	2.0%
	Roof Line raised at forward of B-pillar	0.5%
	Faster A pillar rake angle	0.5%
	Shorter C pillar	1.0%
	Low drag wheels	1.0%
AERO10	Rear Spoiler	1.0%
	Wheel Deflector / Air outlet inside wheel housing	1.0%
	Bumper Lip	1.0%
	Rear Diffuser	2.0%
AERO15	Underbody Cover Incl. Rear axle cladding)	3.0%
	Lowering ride height by 10mm	2.0%
AERO20	Active Grill Shutters	3.0%
	Extend Air dam	2.0%

Table III-27 – Combinations of Technologies That Could Achieve Aerodynamic Improvements Used in the Current Analyses for Pickup Trucks

AERO IMPROVEMENT LEVEL	COMPONENTS	EFFECTIVENESS (%)
AERO5	Whole Body Styling (Shape Optimization)	1.5%
	Faster A pillar rake angle	0.5%
	Rear Spoiler	1.0%
	Wheel Deflector / Air outlet inside wheel housing	1.0%
	Bumper Lip	1.0%
AERO10	Rear Diffuser	2.0%
	Underbody Cover Incl. Rear axle cladding)	3.0%
AERO15	Active Grill Shutters	3.0%
	Extend Air dam	2.0%

As discussed further in Section III.D.8, this analysis assumes manufacturers apply off-cycle technology at rates defined in the Market Data file. While the AERO levels in the analysis are technology-agnostic, achieving AERO20 improvements does assume the use of active grille shutters, which is an off-cycle technology.

Auto Innovators provided two comments on aerodynamic

improvements. Auto Innovators commented that it “does not recommend considering additional aerodynamic improvements (such as 25 percent aerodynamic improvements, etc.). Some additional reductions in aerodynamic forces may be possible if

side view mirrors were no longer required by NHTSA and FMVSSs.”⁴⁷⁴

We agree with Auto Innovators that we should not assume additional aerodynamics technology adoption. We do not exceed 20 percent aerodynamic improvement for all body styles and 15

⁴⁷⁴ Auto Innovators, Docket No. NHTSA–2021–0053–1492, at pp. 62, 135.

percent improvement for the body styles discussed below.

We also agree with Auto Innovators that side view mirrors cause additional aerodynamic drag. Due to existing Federal motor vehicle safety regulations, we currently do not consider aerodynamic improvements from removing side view mirrors in the CAFE Model analysis.⁴⁷⁵

(b) Aerodynamics Analysis Fleet Assignments

We use a relative performance approach to assign an initial level of aerodynamic drag reduction technology to each vehicle. Each AERO level represents a percent reduction in a vehicle's aerodynamic drag coefficient (C_d) from a baseline value for its body style. For a vehicle to achieve AERO5, the C_d must be at least 5 percent below the baseline for the body style; for AERO10, 10 percent below the baseline, and so on. Baseline aerodynamic assignment is therefore a three-step process: Each vehicle in the fleet is assigned a body style, the average drag coefficient is calculated for each body style, and the drag coefficient for each vehicle model is compared to the average for the body style.

We assign every vehicle in the fleet a body style; available body styles included convertible, coupe, sedan, hatchback, wagon, SUV, pickup, minivan, and van. These assignments do not necessarily match the body styles that manufacturers use for marketing purposes. Instead, we assign them based on analyst judgement, taking into account how a vehicle's AERO and vehicle technology class assignments are affected. Different body styles offer different utility and have varying levels of baseline form drag. In addition, frontal area is a major factor in aerodynamic forces, and the frontal area varies by vehicle. This analysis considers both frontal area and body style as utility factors affecting aerodynamic forces; therefore, the analysis assumes all reduction in aerodynamic drag forces come from improvement in the drag coefficient.

We computed the average drag coefficients for each body style using the MY 2015 drag coefficients published by manufacturers, which were used as

the baseline values in the analysis. We harmonize the Autonomie simulation baselines with the analysis fleet assignment baselines to the fullest extent possible.⁴⁷⁶

We source the drag coefficients for each vehicle in the analysis fleet from manufacturer specification sheets, when possible. However, manufacturers did not consistently publicly report drag coefficients for MY 2020 vehicles. If we could not find a publicly reported drag coefficient, analyst judgment was sometimes used to assign an AERO level. If no level was manually assigned, we used the drag coefficient obtained from manufacturers to build the MY 2016 fleet,⁴⁷⁷ if available. The MY 2016 drag coefficient values may not accurately reflect the current technology content of newer vehicles but are, in many cases, the most recent data available.

(c) Aerodynamics Adoption Features

As already discussed, we use a relative performance approach to assign current aerodynamic technology (AERO) level to a vehicle. For some body styles with different utility, such as pickup trucks, SUVs and minivans, frontal area can vary, and this can affect the overall aerodynamic drag forces. In order to maintain vehicle utility and functionality related to passenger space and cargo space, we assume all technologies that improve aerodynamic drag forces do so by reducing C_d while maintaining frontal area.

Technology pathway logic for levels of aerodynamic improvement consists of a linear progression, with each level superseding all previous ones. Technology paths for AERO are illustrated in Figure III–15.

The model does not consider the highest AERO levels for certain body styles. In these cases, this means that AERO20, and sometimes AERO15, can neither be assigned in the baseline fleet nor adopted by the model. For these body styles, there are no commercial examples of drag coefficients that demonstrate the required AERO15 or AERO20 improvement over baseline levels. We also deemed the most advanced levels of aerodynamic drag simulated as not technically practicable

given the form drag of the body style and costed technology, especially given the need to maintain vehicle functionality and utility, such as interior volume, cargo area, and ground clearance. In short, we 'skipped' AERO15 for minivan body styles, and 'skipped' AERO20 for convertible, minivan, pickup, and wagon body styles.

We also do not allow application of AERO15 and AERO20 technology to vehicles with more than 780 horsepower. There are two main types of vehicles that informed this threshold: Performance internal combustion engine (ICE) vehicles and high-power battery electric vehicles (BEVs). In the case of the former, we recognize that manufacturers tune aerodynamic features on these vehicles to provide desirable downforce at high speeds and to provide sufficient cooling for the powertrain, rather than reducing drag, resulting in middling drag coefficients despite advanced aerodynamic features. Therefore, manufacturers may have limited ability to improve aerodynamic drag coefficients for high performance vehicles with internal combustion engines without reducing horsepower. 1,655 units of sales volume in the baseline fleet include limited application of aerodynamic technologies because of ICE vehicle performance.⁴⁷⁸

In the case of high-power battery electric vehicles, the 780-horsepower threshold is set above the highest peak system horsepower present on a BEV in the 2020 fleet. BEVs have different aerodynamic behavior and considerations than ICE vehicles, allowing for features such as flat underbodies that significantly reduce drag.⁴⁷⁹ BEVs are therefore more likely to achieve higher AERO levels, so the horsepower threshold is set high enough that it does not restrict AERO15 and AERO20 application. Note that the CAFE Model does not force high levels of AERO adoption; rather, higher AERO levels are usually adopted organically by BEVs because significant drag reduction allows for smaller batteries and, by extension, cost savings. BEVs represent 252,023 units of sales volume in the baseline fleet.⁴⁸⁰

⁴⁷⁵ Federal motor vehicle safety standard (FMVSS) No. 111, "Rear Visibility," currently requires that vehicles be equipped with rearview mirrors to provide drivers with a view of objects that are to their side or to their side and rear.

⁴⁷⁶ See TSD Chapter 2.4.2 for a table of vehicle attributes used to build the Autonomie baseline vehicle models. That table includes a drag coefficient for each vehicle class.

⁴⁷⁷ See 83 FR 42986 (Aug. 24, 2018). The MY 2016 fleet was built to support the 2018 NPRM.

⁴⁷⁸ Market Data file.

⁴⁷⁹ 2020 EPA Automotive Trends Report, at p. 227.

⁴⁸⁰ Market Data file.

(d) Aerodynamics Effectiveness Modeling

To determine aerodynamic effectiveness, the CAFE Model and Autonomie use individually assigned road load technologies for each vehicle to appropriately assign initial road load levels and appropriately capture benefits of subsequent individual road load improving technologies.

The current analysis included four levels of aerodynamic improvements, AERO5, AERO10, AERO15, and AERO20, representing 5, 10, 15, and 20 percent reduction in drag coefficient (Cd), respectively. We assume that aerodynamic drag reduction can only

come from reduction in Cd and not from reduction of frontal area, to maintain vehicle functionality and utility, such as passenger space, ingress/egress ergonomics, and cargo space.

The effectiveness values for the aerodynamic improvement levels relative to AERO0, for all ten vehicle technology classes, are shown in Figure III-16. Each of the effectiveness values shown is representative of the improvements seen for upgrading only the listed aerodynamic technology level for a given combination of other technologies. In other words, the range of effectiveness values seen for each specific technology (e.g., AERO 15)

represents the addition of AERO15 technology (relative to AERO0 level) for every technology combination that could select the addition of AERO15. It must be emphasized that the change in fuel consumption values between entire technology keys is used,⁴⁸¹ and not the individual technology effectiveness values. Using the change between whole technology keys captures the complementary or non-complementary interactions among technologies. The box shows the inner quartile range (IQR) of the effectiveness values and whiskers extend out $1.5 \times$ IQR. The dots outside the whiskers show effectiveness values outside those thresholds.

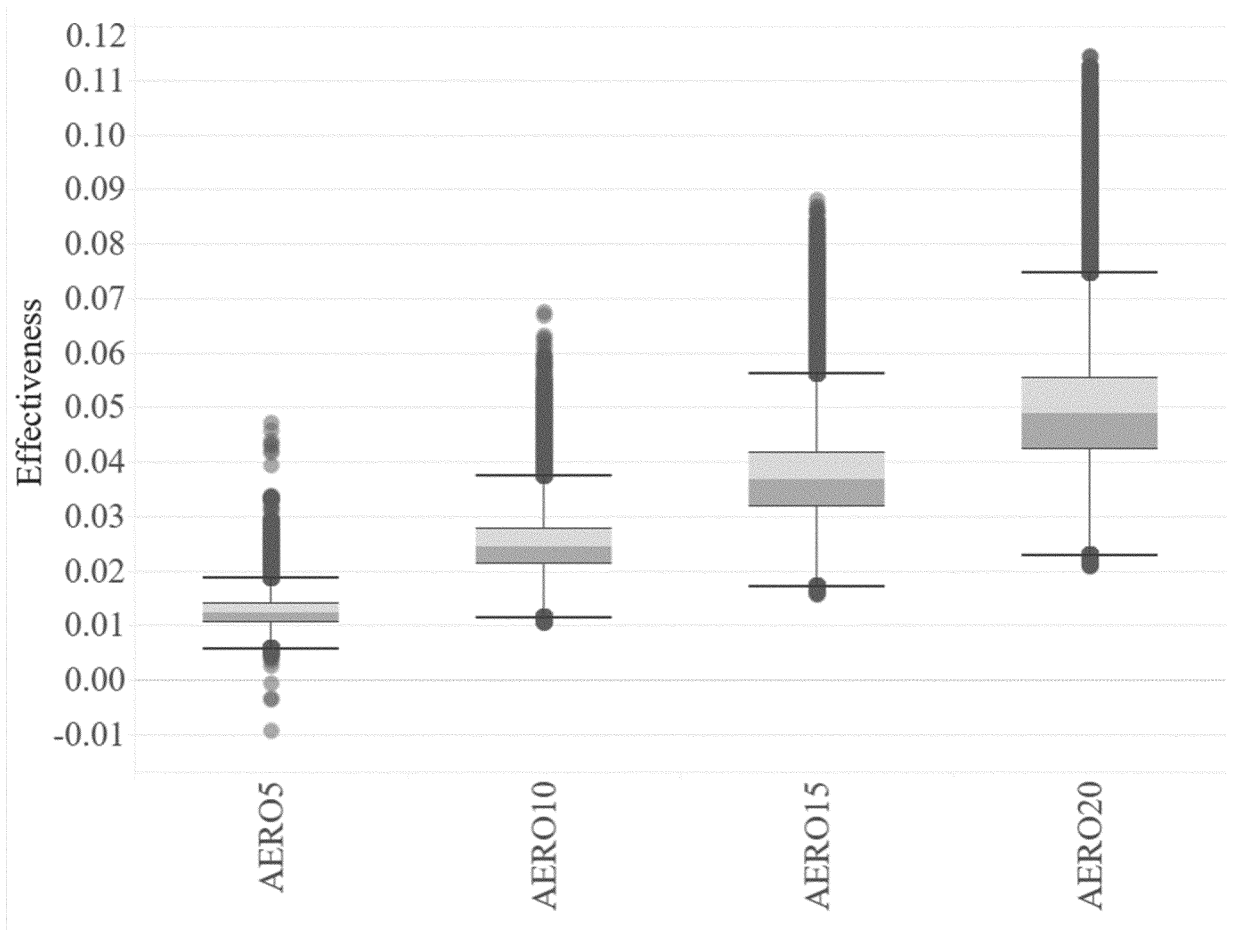

Figure III-16 – AERO Technology Effectiveness⁴⁸²

(e) Aerodynamics Costs

This analysis uses the AERO technology costs established in the 2020 final rule that are based on confidential

business information submitted by the automotive industry in advance of the 2018 NPRM,⁴⁸³ and on our assessment of manufacturing costs for specific

aerodynamic technologies.⁴⁸⁴ We received no additional comments from stakeholders regarding the costs established in the 2018 NPRM, and

⁴⁸¹ Technology key is the unique collection of technologies that constitutes a specific vehicle, see TSD Chapter 2.4.7 for more detail.

⁴⁸² The data used to create this figure can be found in the FE_1 Improvements file.

⁴⁸³ See the PRIA accompanying the 2018 NPRM, Chapter 6.3.10.1.2.1.2, for a discussion of these cost estimates.

⁴⁸⁴ See the FRIA accompanying the 2020 final rule, Chapter VI.C.5.e.

continued to use the established costs for the 2020 final rule and this analysis.

Table III–28 shows examples of costs for AERO technologies as applied to the medium car and pickup truck vehicle classes in select model years. The cost to achieve AERO5 is relatively low, as

most of the improvements can be made through body styling changes. The cost to achieve AERO10 is higher than AERO5, due to the addition of several passive aerodynamic technologies, and the cost to achieve AERO15 and

AERO20 is higher than AERO10 due to use of both passive and active aerodynamic technologies. For a full list of all absolute aerodynamic technology costs used in the analysis across all model years see the Technologies file.

Table III-28 – Examples of Costs for Aerodynamic Reduction Technologies in 2018\$ for Medium Cars and Pickup Trucks for Select Model Years

TECHNOLOGY	MEDIUM CAR COSTS (2018\$)			PICKUP COSTS (2018\$)		
	MY 2020	MY 2025	MY 2030	MY 2020	MY 2025	MY 2030
AERO0	0.00	0.00	0.00	0.00	0.00	0.00
AERO5	53.96	48.70	45.73	53.96	48.70	45.73
AERO10	110.32	99.56	93.49	110.32	99.56	93.49
AERO15	155.88	140.68	132.10	275.80	248.90	233.72
AERO20	275.80	248.90	233.72	-	-	-

Tire Rolling Resistance

Tire rolling resistance is a road load force that arises primarily from the energy dissipated by elastic deformation of a vehicle's tires as they roll. Tire design characteristics (for example, materials, construction, and tread design) have a strong influence on the amount and type of deformation and the energy the tire dissipates. Designers can select these characteristics to minimize rolling resistance. However, these characteristics may also influence other performance attributes, such as durability, wet and dry traction, handling, and ride comfort.

Lower rolling resistance tires have characteristics that reduce frictional losses associated with the energy dissipated mainly in the deformation of the tires under load, thereby improving fuel economy. OEMs increasingly specify low rolling resistance tires in new vehicles, and they are also increasingly available from aftermarket tire vendors. They commonly include attributes such as higher inflation pressure, material changes, tire construction optimized for lower hysteresis, geometry changes (e.g., reduced aspect ratios), and reduced sidewall and tread deflection. These changes are commonly accompanied by additional changes to vehicle suspension tuning and/or suspension design to mitigate any potential impact on other performance attributes of the vehicle.

We continue to assess the potential impact of tire rolling resistance changes on vehicle safety. We have been

following the industry developments and trends in application of rolling resistance technologies to light duty vehicles. As stated in the NAP special report on Tires and Passenger Vehicle Fuel Economy,⁴⁸⁵ national crash data does not provide data about tire structural failures specifically related to tire rolling resistance, because the rolling resistance of a tire at a crash scene cannot be determined. However, other metrics like brake performance compliance test data are helpful to show trends like that stopping distance has not changed in the last ten years,⁴⁸⁶ during which time many manufacturers have installed low rolling resistance tires in their fleet—meaning that manufacturers were successful in improving rolling resistance while maintaining stopping distances through tire design, tire materials, and/or braking system improvements. In addition, NHTSA has addressed other tire-related issues through rulemaking,⁴⁸⁷ and continues to research tire problems such as blowouts, flat tires, tire or wheel deficiency, tire or wheel failure, and tire degradation.⁴⁸⁸ However, there are currently no data

⁴⁸⁵ Tires and Passenger Vehicle Fuel Economy: Informing Consumers, Improving Performance—Special Report 286 (2006), available at <https://www.nap.edu/read/11620/chapter/6>.

⁴⁸⁶ See, e.g., NHTSA Office of Vehicle Safety Compliance, Compliance Database, <https://one.nhtsa.gov/cars/problems/comply/index.cfm>.

⁴⁸⁷ 49 CFR 571.138, Tire pressure monitoring systems.

⁴⁸⁸ Tire-Related Factors in the Pre-Crash Phase, DOT HS 811 617 (April 2012), available at <https://crashstats.nhtsa.dot.gov/Api/Public/ViewPublication/811617>.

connecting low rolling resistance tires to accident or fatality rates.

NHTSA conducted tire rolling resistance tests and wet grip index tests on original equipment tires installed on new vehicles. The tests showed that there is no degradation in wet grip index values (i.e., no degradation in traction) for tires with improved rolling resistance technology. With better tire design, tire compound formulations and improved tread design, tire manufacturers have tools to balance stopping distance and reduced rolling resistance. Tire manufacturers can use “higher performance materials in the tread compound, more silica as reinforcing fillers and advanced tread design features” to mitigate issues related to stopping distance.⁴⁸⁹

U.S. Tire Manufacturers Association (USTMA) commented on NHTSA's conclusion that the agency did not observe any unacceptable tradeoff between tire rolling resistance and wet grip performance, which “NHTSA correctly recognized is due to advanced tire design, rubber compounding and manufacturing technologies.” However, USTMA cautioned that “this inverse relationship between rolling resistance and wet grip performance still exists, and as the tire industry continues to enhance rolling resistance performance, new and/or enhanced countermeasures will also need to be developed to assure

⁴⁸⁹ Jesse Snyder, A big fuel saver: Easy-rolling tires (but watch braking) (July 21, 2008), <https://www.autonews.com/article/20080721/OEM01/307219960/a-big-fuel-saver-easy-rolling-tires-but-watch-braking>. Last visited December 3, 2019.

no unacceptable impact to wet grip performance.”⁴⁹⁰

The following sections discuss levels of tire rolling resistance technology considered in the CAFE Model, how the technology was assigned in the analysis fleet, adoption features specified to maintain performance, effectiveness, and cost.

(a) Tire Rolling Resistance in the CAFE Model

We continue to consider two levels of improvement for low rolling resistance tires in the analysis: the first level of low rolling resistance tires considered reduced rolling resistance 10 percent from an industry-average baseline rolling resistance coefficient (RRC) value, while the second level reduced rolling resistance 20 percent from the baseline.⁴⁹¹

We selected the industry-average RRC baseline of 0.009 based on a CONTROLTEC study prepared for the California Air Resources Board,⁴⁹² in addition to confidential business information submitted by manufacturers prior to the 2018 NPRM analysis. The average RRC from the CONTROLTEC study, which surveyed 1,358 vehicle models, was 0.009.⁴⁹³ CONTROLTEC also compared the findings of their survey with values provided by Rubber Manufacturers Association (renamed USTMA–U.S. Tire Manufacturers Association) for original equipment tires. The average RRC from the data provided by RMA was 0.0092,⁴⁹⁴ compared to average of 0.009 from CONTROLTEC.

In past agency actions, commenters have argued that based on available data on current vehicle models and the likely possibility that there would be additional tire improvements over the next decade, we should consider ROLL30 technology, or a 30 percent reduction of tire rolling resistance over the baseline.⁴⁹⁵

⁴⁹⁰ USTMA, Docket No. NHTSA–2021–0053–1612, at 2.

⁴⁹¹ To achieve ROLL10, the tire rolling resistance must be at least 10 percent better than baseline (.0081 or better). To achieve ROLL20, the tire rolling resistance must be at least 20 percent better than baseline (.0072 or better).

⁴⁹² Technical Analysis of Vehicle Load Reduction by CONTROLTEC for California Air Resources Board (April 29, 2015).

⁴⁹³ The RRC values used in this study were a combination of manufacturer information, estimates from coast down tests for some vehicles, and application of tire RRC values across other vehicles on the same platform.

⁴⁹⁴ Technical Analysis of Vehicle Load Reduction by CONTROLTEC for California Air Resources Board (April 29, 2015) at page 40.

⁴⁹⁵ Wesley Dyer, Docket No. NHTSA–2018–0067–11985, at p. 49.

As stated in the Joint TSD for the 2012 final rule for MY 2017–2025 and 2020 final rule, tire technologies that enable rolling resistance improvements of 10 and 20 percent have been in existence for many years.⁴⁹⁶ Achieving improvements of up to 20 percent involves optimizing and integrating multiple technologies, with a primary contributor being the adoption of a silica tread technology. Tire suppliers have indicated that additional innovations are necessary to achieve the next level of low rolling resistance technology on a commercial basis, such as improvements in material to retain tire pressure, and tread design to manage both stopping distance and wet traction.⁴⁹⁷

The agency believes that the tire industry is in the process of moving automotive manufacturers towards higher levels of rolling resistance technology in the vehicle fleet. Importantly, as shown below, the MY 2020 baseline fleet does include a higher percentage of vehicles with ROLL20 technology than the MY 2017 fleet. However, we believe that at this time, the emerging tire technologies that would achieve 30 percent improvement in rolling resistance, like changing tire profile, stiffening tire walls, or adopting improved tires along with active chassis control,⁴⁹⁸ among other technologies, will not be available for widespread commercial adoption in the fleet during the rulemaking timeframe. As a result, we continue to not to incorporate 30 percent reduction in rolling resistance technology.

USTMA agreed with this assessment, and commented that “its members will continue to develop advanced rolling resistance technologies for future adoption, since vehicle manufacturers continue to prioritize rolling resistance as one of the more cost-effective ways to achieve advancements in vehicle fuel economy.”⁴⁹⁹ Auto Innovators, in their comments to both NHTSA and EPA, also discouraged the addition of 30 percent tire rolling resistance, stating that “performance neutrality for cold weather traction, hot weather performance, wet weather traction, load handling (for addition weight of batteries, for instance), wear and durability, and noise, vibration, and harshness can be challenging to achieve for 20 [percent] tire rolling resistance

⁴⁹⁶ EPA–420–R–12–901, at p. 3–210.

⁴⁹⁷ 2011 NAS Report, at p. 103.

⁴⁹⁸ Mohammad Mehdi Davari, Rolling resistance and energy loss in tyres (May 20, 2015), available at https://www.sveafordon.com/media/42060/SVEA-Presentation_Davari_public.pdf. Last visited December 30, 2019.

⁴⁹⁹ USTMA, at 2.

reduction, and the technology pathway to ROLL30 for many vehicles remains unclear.”⁵⁰⁰

We will continue to monitor this issue and consider any additional advancements in tire rolling resistance technology for future analyses.

(b) Tire Rolling Resistance Analysis Fleet Assignments

Tire rolling resistance is not a part of tire manufacturers’ publicly released specifications and thus it is difficult to assign this technology to the analysis fleet. Manufacturers also often offer multiple wheel and tire packages for the same nameplates, further increasing the complexity of this assignment. We employed an approach consistent with previous rulemaking in assigning this technology. We relied on previously submitted rolling resistance values that were supplied by manufacturers in the process of building older fleets and bolstered it with agency-sponsored tire rolling resistance testing by Smithers.⁵⁰¹

We carried over rolling resistance assignments for nameplates where manufacturers had submitted data on the vehicles’ rolling resistance values, even if the vehicle was redesigned. If Smithers data was available, we replaced any older or missing values with that updated data. Those vehicles for which no information was available from either previous manufacturer submission or Smithers data were assigned to ROLL0. All vehicles under the same nameplate were assigned the same rolling resistance technology level even if manufacturers do outfit different trim levels with different wheels and tires.

The MY 2020 analysis fleet includes the following breakdown of rolling resistance technology: 44 percent at ROLL0, 20 percent at ROLL10, and 36 percent at ROLL20, which shows that the majority of the fleet has now adopted some form of improved rolling resistance technology. The majority of the change from the MY 2017 analysis fleet has been in implementing ROLL20 technology. There is likely more proliferation of rolling resistance technology, but we would need further information from manufacturers in order to account for it. Accordingly, we made no changes to tire rolling

⁵⁰⁰ Auto Innovators, Docket No. NHTSA–2021–0053–1492, at 134.

⁵⁰¹ See memo to Docket No. NHTSA–2021–0053, Evaluation of Rolling Resistance and Wet Grip Performance of OEM Stock Tires Obtained from NCAP Crash Tested Vehicles Phase One and Two. NHTSA used tire rolling resistance coefficient values from this project to assign baseline tire rolling resistance technology in the MY 2020 analysis fleet and is therefore providing the draft project appendices for public review and comment.

resistance assignments for this final rule.

(C) Tire Rolling Resistance Adoption Features

Rolling resistance technology can be adopted with either a vehicle refresh or redesign. In some cases, low rolling resistance tires can affect traction, which may adversely impact acceleration, braking, and handling characteristics for some high-performance vehicles. Similar to past rulemakings, the agency recognizes that to maintain performance, braking, and handling functionality, some high-performance vehicles would not adopt low rolling resistance tire technology. For cars and SUVs with more than 405 horsepower (hp), the agency restricted the application of ROLL20. For cars and SUVs with more than 500 hp, the agency restricted the application of any additional rolling resistance technology (ROLL10 or ROLL20). The agency developed these cutoffs based on a review of confidential business information and the distribution of rolling resistance values in the fleet. We received no comments on these adoption features and made no changes for this final rule analysis.

(d) Tire Rolling Resistance Effectiveness Modeling

As discussed above, the baseline rolling resistance value from which rolling resistance improvements are measured is 0.009, based on a thorough review of confidential business information submitted by industry, and a review of other literature. To achieve ROLL10, the tire rolling resistance must be at least 10 percent better than baseline (.0081 or better). To achieve ROLL20, the tire rolling resistance must be at least 20 percent better than baseline (.0072 or better).

We determined effectiveness values for rolling resistance technology adoption using Autonomie. Figure III–17 below shows the range of effectiveness values used for adding tire rolling resistance technology to a vehicle in this analysis. The graph shows the change in fuel consumption values between entire technology keys,⁵⁰² and not the individual technology effectiveness values. Using the change between whole technology keys captures the complementary or

⁵⁰² Technology key is the unique collection of technologies that constitutes a specific vehicle, see TSD Chapter 2.4.7 for more information.

non-complementary interactions among technologies. In the graph, the box shows the interquartile range (IQR) of the effectiveness values and whiskers extend out $1.5 \times$ IQR. The dots outside of the whiskers show values for effectiveness that are outside these bounds.

The data points with the highest effectiveness values are almost all exclusively BEV and FCV technology combinations for medium sized nonperformance cars. The effectiveness for these vehicles, when the low rolling resistance technology is applied, is amplified by a complementary effect, where the lower rolling resistance reduces road load and allows a smaller battery pack to be used (and still meet range requirements). The smaller battery pack reduces the overall weight of the vehicle, further reducing road load, and improving fuel efficiency. This complimentary effect is experienced by all the vehicle technology classes, but the strongest effect is on the midsize vehicle non-performance classes and is only captured in the analysis through the use of full vehicle simulations, demonstrating the full interactions of the technologies.

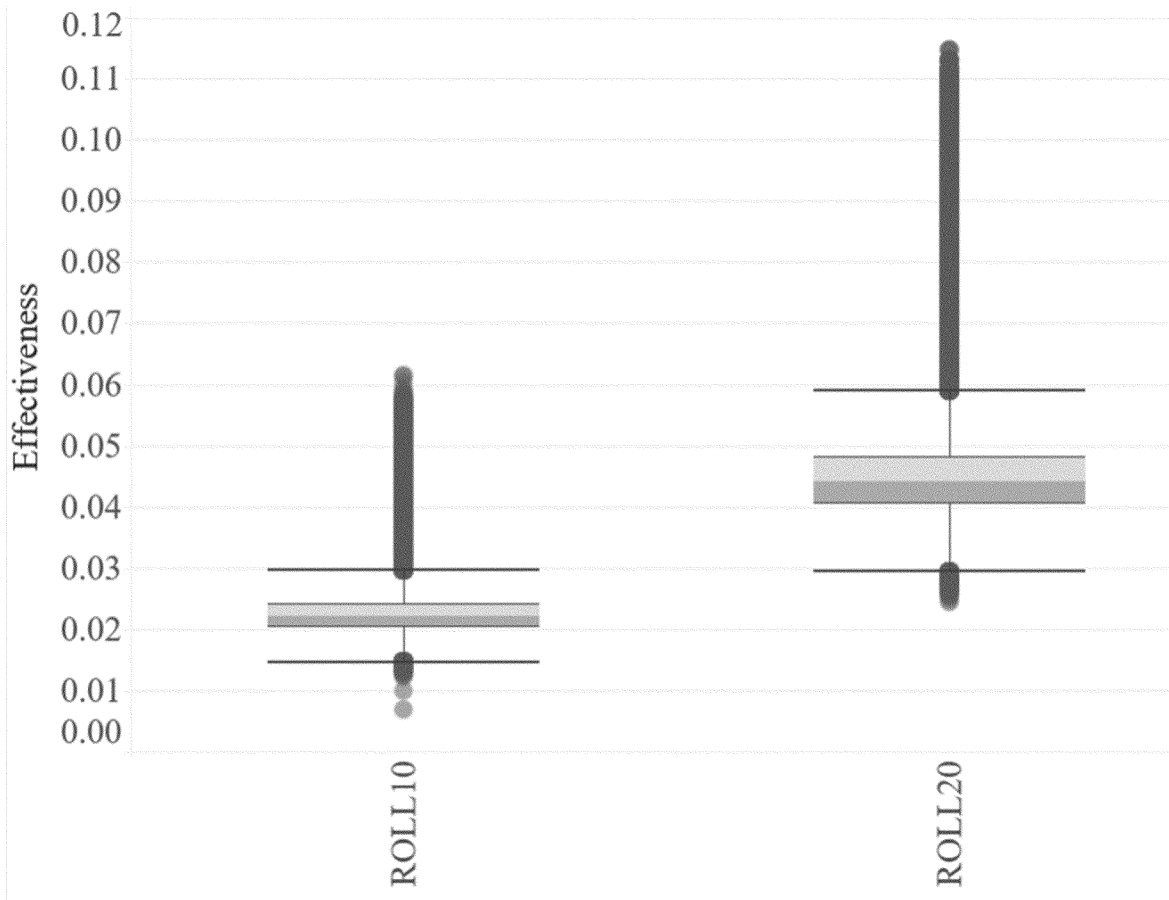

Figure III-17 – ROLL Technology Effectiveness

(e) Tire Rolling Resistance Costs

For this final rule analysis, we continue to use the same DMC values for ROLL technology that were used for the 2020 final rule, which are based on

NHTSA’s MY 2011 CAFE final rule and the 2006 NAS/NRC report.⁵⁰³ Table III-29 shows the different levels of tire rolling resistance technology cost for all vehicle classes across select model

years, which shows how the learning rate for ROLL technologies impacts the cost. For all ROLL absolute technology costs used in the analysis across all model years see the Technologies file.

Table III-29 – Examples of Costs for Rolling Resistance Reduction Technologies in 2018\$ for Select Model Years

Technology	MY 2020	MY 2025	MY 2030
ROLL0	0.00	0.00	0.00
ROLL10	7.13	6.52	6.16
ROLL20	51.18	44.04	40.70

7. Other Vehicle Technologies

We included four other vehicle technologies in the analysis—electric power steering (EPS), improved accessory devices (IACC), low drag brakes (LDB), and secondary axle disconnect (SAX). The CAFE Model applied the effectiveness values for each

of these technologies directly, with unique effectiveness values for each technology and for each technology class, rather than using Autonomie effectiveness estimates. We used this methodology in these four cases because the effectiveness of these technologies varies little with combinations of other

technologies. Also, applying these technologies directly in the CAFE Model significantly reduces the required runtime of Autonomie simulations.

(a) Electric Power Steering

Electric power steering reduces fuel consumption by reducing load on the engine. Specifically, it reduces or

⁵⁰³ “Tires and Passenger Vehicle Fuel Economy,” Transportation Research Board Special Report 286,

National Research Council of the National

Academies, 2006, Docket No. EPA-HQ-OAR-2009-0472-0146.

eliminates the parasitic losses associated with engine-driven power steering pumps, which pump hydraulic fluid continuously through the steering actuation system even when no steering input is present. By selectively powering the electric assist only when steering input is applied, the power consumption of the system is reduced in comparison to the traditional “always-on” hydraulic steering system. Power steering may be electrified on light duty vehicles with standard 12V electrical systems and is also an enabler for vehicle electrification because it provides power steering when the engine is off (or when no combustion engine is present).

Power steering systems can be electrified in two ways. Manufacturers may choose to eliminate the hydraulic portion of the steering system and provide electric-only power steering

(EPS) driven by an independent electric motor, or they may choose to move the hydraulic pump from a belt-driven configuration to a stand-alone electrically driven hydraulic pump. The latter system is commonly referred to as electro-hydraulic power steering (EHPS). As stated in past rulemakings, manufacturers have told us that full EPS systems are being developed for all types of light-duty vehicles, as well as large trucks.

We described in past rulemakings that, like low drag brakes, EPS can be difficult to observe and assign to the analysis fleet, however, it is found more frequently in publicly available information than low drag brakes. Based on comments received during the 2020 rulemaking, the agency increased EPS application rate to nearly 90 percent for the 2020 final rule. The agency is maintaining this level of EPS fleet

penetration for this analysis, recognizing that some specialized, unique vehicle types or configurations still implement hydraulically actuated power steering systems for the baseline fleet model year.

The effectiveness of both EPS and EHPS is derived from the decoupling of the pump from the crankshaft and is considered to be practically the same for both. Thus, a single effectiveness value is used for both EPS and EHPS. As indicated in the Table III–30, the effectiveness of EPS and EHPS varies based on the vehicle technology class it is being applied to. This variance is a direct result of vehicle size and the amount of energy required to turn the vehicle’s two front wheels about their vertical axis. More simply put, more energy is required for vehicles that weigh more and, typically, have larger tire contact patches.

Table III-30 – Fuel Consumption Improvement Values for Electric Power Steering

Tech Class	EPS
SmallCar	1.50%
SmallCarPerf	
MedCar	1.30%
MedCarPerf	
SmallSUV	1.20%
SmallSUVPerf	
MedSUV	1.00%
MedSUVPerf	
Pickup	0.80%
PickupHT	

(b) Improved Accessories

Engine accessories typically include the alternator, coolant pump, cooling fan, and oil pump, and are traditionally mechanically driven via belts, gears, or directly by other rotating engine components such as camshafts or the crankshaft. These can be replaced with improved accessories (IACC), which may include high efficiency alternators, electrically driven (*i.e.*, on-demand) coolant pumps, electric cooling fans, variable geometry oil pumps, and a mild regeneration strategy. Replacing lower-efficiency and/or mechanically driven components with these improved accessories results in a reduction in fuel consumption, as the improved accessories can conserve energy by being turned on/off “on demand” in some cases, driven at partial load as needed, or by operating more efficiently.

For example, electric coolant pumps and electric powertrain cooling fans

provide better control of engine cooling. Flow from an electric coolant pump can be varied, and the cooling fan can be shut off during engine warm-up or cold ambient temperature conditions, reducing warm-up time, fuel enrichment requirements, and ultimately reducing parasitic losses.

IACC technology is difficult to observe and therefore there is uncertainty in assigning it to the analysis fleet. As in the past, we rely on industry-provided information and comments to assess the level of IACC technology applied in the fleet. We believe there continues to be opportunity for further implementation of IACC. The analysis has an IACC fleet penetration of approximately eight percent compared to the six percent value in the MY 2017 analysis fleet used for the 2020 final rule analysis.

The agency believes improved accessories may be incorporated in coordination with powertrain related

changes occurring at either a vehicle refresh or vehicle redesign. This coordination with powertrain changes enables related design and tooling changes to be implemented and systems development, functionality and durability testing to be conducted in a single product change program to efficiently manage resources and costs.

This analysis carries forward work on the effectiveness of IACC systems conducted in the Draft TAR and EPA Proposed Determination that is originally founded in the 2002 NAS Report⁵⁰⁴ and confidential manufacturer data. This work involved gathering information by monitoring press reports, holding meetings with suppliers and OEMs, and attending industry technical conferences. The

⁵⁰⁴ National Research Council 2002. *Effectiveness and Impact of Corporate Average Fuel Economy (CAFE) Standards*. Washington, DC: The National Academies Press. <https://doi.org/10.17226/10172>.

resulting effectiveness estimates we use are shown in Table III–31. As indicated in this table, the effectiveness values of IACC varies based on the vehicle technology class it is being applied to.

This variance, like EPS, is a direct result of vehicle size as well as the amount of energy generated by the alternator, the size of the coolant pump to the cool the necessary systems, the size of the

cooling fan required, among other characteristics and it directed related to a vehicle size and mass.

Table III-31 – Fuel Consumption Improvement Values for Improved Accessories

Tech Class	IACC
SmallCar	1.85%
SmallCarPerf	
MedCar	2.36%
MedCarPerf	
SmallSUV	1.74%
SmallSUVPerf	
MedSUV	2.34%
MedSUVPerf	
Pickup	2.15%
PickupHT	

(c) Low Drag Brakes

We have defined low drag brakes (LDB) as brakes that reduce the sliding friction of disc brake pads on rotors when the brakes are not engaged because the brake pads are pulled away from the rotating disc either by mechanical or electric methods since 2009 for the MY 2011 CAFE rule.⁵⁰⁵ At that time, we estimated the effectiveness of LDB technology to be a range from 0.5–1.0 percent, based on CBI data. We applied a learning curve to the estimated cost for LDB, but noted that the technology was considered high volume, mature, and stable.

Confidential manufacturer comments in response to the NPRM for MY 2011 (73 FR 24352, May 2, 2008) indicated that most passenger cars have already adopted LDB technology, but ladder frame trucks have not.

We and EPA used the same definition for LDB in the MY 2012–2016 joint rule, with an estimated effectiveness of up to 1 percent based on CBI data.⁵⁰⁶ We only allowed LDB technology to be applied to large car, minivan, medium and large truck, and SUV classes because the agency determined the technology was already largely utilized in most other subclasses. The 2011 NAS committee also utilized our definition for LDB and

added that most new vehicles have low-drag brakes.⁵⁰⁷ The committee confirmed that the impact over conventional brakes may be about a 1 percent reduction of fuel consumption.

For the 2012 final rule for MY 2017–2025, however, we and EPA updated the effectiveness estimate for LDB to 0.8 percent based on a 2011 Ricardo study and updated lumped-parameter model.⁵⁰⁸ The agencies considered LDB technology to be off the learning curve (*i.e.*, the DMC does not change year-over-year). The 2015 NAS Report continued to use the agencies' definition for LDB and commented that the 0.8 percent effectiveness estimate is a reasonable estimate.⁵⁰⁹ The 2015 NAS committee did not opine on the application of LDB technology in the fleet. The agencies used the same definition, cost, and effectiveness estimates for LDB in the Draft TAR, but also noted the existence of zero drag brake systems which use electrical actuators that allow brake pads to move farther away from the rotor.⁵¹⁰ However, the agencies did not include zero drag brake technology in either compliance simulation. EPA continued with this approach in its first 2017 Proposed

Determination that the standards through 2025 were appropriate.⁵¹¹

In the 2020 final rule, the agencies applied LDB sparingly in the MY 2017 analysis fleet using the same cost and effectiveness estimates from the 2011 Ricardo study, with approximately less than 15 percent of vehicles being assigned the technology. In addition, we noted the existence of zero drag brakes in production for some BEVs, similar to the summary in the Draft TAR, but did not opine on the existence of zero drag brakes in the fleet. Some stakeholders commented to the 2020 rule that other vehicle technologies, including LDB, were actually overapplied in the analysis fleet.

For this analysis, we considered the conflicting statements that LDB were both universally applied in new vehicles and that the new vehicle fleet still had space to improve LDB technology. We determined that LDB technology as previously defined going back to the MY 2011 rule (73 FR 24352, May 2, 2008) was universally applied in the MY 2020 fleet. However, we determined that zero drag brakes, the next level of brake technology, was sparingly applied in the MY 2020 analysis fleet. Currently, we do not believe that zero drag brake systems will be available for wide scale application in the rulemaking timeframe and we did not include it as a technology for this analysis. We sought comment on the issue, including any data on the use

⁵⁰⁵ Final Regulatory Impact Analysis, Corporate Average Fuel Economy for MY 2011 Passenger Cars and Light Trucks (March 2009), at V–135.

⁵⁰⁶ Final Regulatory Impact Analysis, Corporate Average Fuel Economy for MY 2012–MY 2016 Passenger Cars and Light Trucks (March 2010), at 249.

⁵⁰⁷ 2011 NAS Report, at 103–104.

⁵⁰⁸ Joint Technical Support Document: Final Rulemaking for 2017–2025 Light-Duty Vehicle Greenhouse Gas Emission Standards and Corporate Average Fuel Economy Standards (August 2012), at 3–211.

⁵⁰⁹ 2015 NAS Report, at 231.

⁵¹⁰ Draft TAR, at 5–207.

⁵¹¹ EPA Proposed Determination TSD, at 2–422.

advanced LDB systems on current and forthcoming production vehicles, but did not receive any comments. We will consider how to define a new level of low drag brake technology that either encompasses the definition of zero drag brakes or similar technology in future rulemakings.

(d) Secondary Axle Disconnect

AWD and 4WD vehicles provide improved traction by delivering torque to the front and rear axles, rather than just one axle. When a second axle is rotating, it tends to consume more energy because of additional losses related to lubricant churning, seal friction, bearing friction, and gear train inefficiencies.⁵¹² Some of these losses may be reduced by providing a secondary axle disconnect function that disconnects one of the axles when driving conditions do not call for torque to be delivered to both.

The terms AWD and 4WD are often used interchangeably, although they have also developed a colloquial distinction, and are two separate systems. The term AWD has come to be associated with light-duty passenger vehicles providing variable operation of one or both axles on ordinary roads. The term 4WD is often associated with larger truck-based vehicle platforms providing a locked driveline configuration and/or a low range gearing meant primarily for off-road use.

Many 4WD vehicles provide for a single-axle (or two-wheel) drive mode that may be manually selected by the user. In this mode, a primary axle (usually the rear axle) will be powered, while the other axle (known as the secondary axle) is not. However, even though the secondary axle and associated driveline components are not receiving engine power, they are still connected to the non-driven wheels and

will rotate when the vehicle is in motion. This unnecessary rotation consumes energy,⁵¹³ and leads to increased fuel consumption that could be avoided if the secondary axle components were completely disconnected and not rotating.

Light-duty AWD systems are often designed to divide variably torque between the front and rear axles in normal driving to optimize traction and handling in response to driving conditions. However, even when the secondary axle is not necessary for enhanced traction or handling, in traditional AWD systems it typically remains engaged with the driveline and continues to generate losses that could be avoided if the axle was instead disconnected. The SAX technology observed in the marketplace disengages one axle (typically the rear axle) for 2WD operation but detects changes in driving conditions and automatically engages AWD mode when it is necessary. The operation in 2WD can result in reduced fuel consumption. For example, Chrysler has estimated the secondary axle disconnect feature in the Jeep Cherokee reduces friction and drag attributable to the secondary axle by 80 percent when in disconnect mode.⁵¹⁴

Observing SAX technology on actual vehicles is very difficult. Manufacturers do not typically identify the technology on technical specifications or other widely available information. We employed an approach consistent with previous rulemaking in assigning this technology. Specifically, we assigned SAX technology based on a combination of publicly available information and previously submitted confidential information. In the analysis fleet, 38 percent of the vehicles that had AWD or 4WD are determined to have SAX

technology. All vehicles in the analysis fleet with FWD or RWD have SAX skipped since SAX technology is a way to emulate FWD or RWD in AWD and 4WD vehicles, respectively. We did not allow for the application of SAX technology to FWD or RWD vehicles because they do not have a secondary driven axle to disconnect.

SAX technology can be adopted by any vehicle in the analysis fleet, including those with a HEV or BEV powertrain,⁵¹⁵ which was identified as having AWD or 4WD. It does not supersede any technology or result in any other technology being excluded for future implementation for that vehicle. SAX technology can be applied during any refresh or redesign.

This analysis carries forward work on the effectiveness of SAX systems conducted in the Draft TAR and EPA Proposed Determination.⁵¹⁶ This work involved gathering information by monitoring press reports, holding meetings with suppliers and OEMs, and attending industry technical conferences. We did not simulate SAX effectiveness in the Autonomie modeling because, similar to LDB, IACC, and EFR, the fuel economy benefits from the technology are not fully captured on the two-cycle test. The secondary axle disconnect effectiveness values, for the most part, have been accepted as plausible based on the rulemaking record and absence of contrary comments. As such, the agency has prioritized its extensive Autonomie vehicle simulation work toward other technologies that are emerging or considered more critical for total system effectiveness. Table III–32 shows the resulting effectiveness estimates we used in this analysis.

⁵¹³ Any time a drivetrain component spins it consumes some energy, primarily to overcome frictional forces.

⁵¹⁴ Brooke, L. "Systems Engineering a new 4x4 benchmark", SAE *Automotive Engineering*, June 2, 2014.

⁵¹⁵ The inefficiencies addressed on ICEs by SAX technology may not be similar enough, or even present, in HEVs or BEVs.

⁵¹⁶ Draft TAR, at 5–412; Proposed Determination TSD, at 2–422.

⁵¹² Pilot Systems, "AWD Component Analysis," Project Report, performed for Transport Canada, Contract T8080–150132, May 31, 2016.

Table III-32 – Fuel Consumption Improvement Values for Secondary Axle Disconnect

Tech Class	SAX
SmallCar	1.40%
SmallCarPerf	
MedCar	1.40%
MedCarPerf	
SmallSUV	1.40%
SmallSUVPerf	
MedSUV	1.30%
MedSUVPerf	
Pickup	1.60%
PickupHT	

(e) Other Vehicle Technology Costs

The cost estimates for EPS, IACC, SAX, and LDB⁵¹⁷ rely on previous work published as part of past rulemakings with learning applied to those cost

values which is founded in the 2002 NAS Report.⁵¹⁸ The cost values are the same values that were used for the Draft TAR and 2020 final rule, updated to 2018 dollars. Table III–33 shows examples of costs for these technologies

across select model years. Note that these costs are the same for all vehicle technology classes. For all absolute EPS, IACC, LDB, and SAX technology costs across all model years, see the Technologies file.

Table III-33 – Examples of Costs for EPS, IACC, LDB, and SAX Technologies in 2018\$ for Select Model Years

Technology	MY 2020	MY 2025	MY 2030
EPS	126.53	117.28	110.90
IACC	169.70	146.67	135.17
LDB	86.42	78.35	73.12
SAX	88.69	80.34	75.15

8. Simulating Air Conditioning Efficiency and Off-Cycle Technologies

Off-cycle and air conditioning (AC) efficiency technologies can provide fuel economy benefits in real-world vehicle operation, but those benefits cannot be fully captured by the traditional 2-cycle test procedures used to measure fuel economy.⁵¹⁹ Off-cycle technologies include technologies like high efficiency alternators and high efficiency exterior lighting.⁵²⁰ AC efficiency technologies are technologies that reduce the operation of or the loads on the compressor, which pressurizes AC refrigerant. The less the compressor operates or the more efficiently it operates, the less parasitic load the compressor places on the engine, resulting in better fuel efficiency.

Vehicle manufacturers have the option to generate credits for off-cycle technologies and improved AC systems under the EPA's CO₂ program and receive an FCIV equal to the value of the benefit not captured on the 2-cycle test under NHTSA's CAFE program. The FCIV is not a "credit" in the NHTSA

CAFE program,⁵²¹ but the FCIVs increase the reported fuel economy of a manufacturer's fleet, which is used to determine compliance. EPA applies FCIVs during determination of a fleet's final average fuel economy reported to NHTSA.⁵²² In the CAFE Model, we only calculate and apply FCIVs at a fleet level for a manufacturer based on the volume of the manufacturer's fleet that contain qualifying technologies.⁵²³

There are three pathways that manufacturers can use to determine the value of AC efficiency and off-cycle adjustments. First, manufacturers can use a predetermined list or "menu" of g/mi values that EPA established for specific off-cycle technologies.⁵²⁴ Second, manufacturers can use 5-cycle testing to demonstrate off-cycle CO₂ benefit;⁵²⁵ the additional tests allow emissions benefits to be demonstrated over some elements of real-world driving not captured by the 2-cycle compliance tests, including high speeds, rapid accelerations, hot temperatures, and cold temperatures. Third, manufacturers can seek EPA approval,

through a notice and comment process, to use an alternative methodology other than the menu or 5-cycle methodology for determining the off-cycle technology improvement values.⁵²⁶ For further discussion of the AC and off-cycle compliance and application process, see Section VII.

We and EPA have been collecting data on the application of these technologies since implementing the AC and off-cycle programs.⁵²⁷ Most manufacturers are applying AC efficiency and off-cycle technologies; in MY 2020, 17 manufacturers employed AC efficiency technologies and 20 manufacturers employed off-cycle technologies, though the level of deployment varies by manufacturer.⁵²⁹

Manufacturers have only recently begun including detailed information on off-cycle and AC efficiency technologies equipped on vehicles in compliance reporting data. For this analysis, though, such information was not sufficiently complete to support a detailed representation of the application of off-cycle technology to specific vehicle

⁵¹⁷ Note that because LDB technology is applied universally as a baseline technology in the MY 2020 fleet, there is functionally zero costs for this technology associated with this rulemaking.

⁵¹⁸ National Research Council 2002. *Effectiveness and Impact of Corporate Average Fuel Economy (CAFE) Standards*. Washington, DC: The National Academies Press. <https://doi.org/10.17226/10172>.

⁵¹⁹ See 49 U.S.C. 32904(c) ("The Administrator shall measure fuel economy for each model and calculate average fuel economy for a manufacturer under testing and calculation procedures prescribed by the Administrator . . . the Administrator shall use the same procedures for passenger automobiles the Administrator used for model year 1975 (weighted 55 percent urban cycle and 45 percent highway cycle), or procedures that give comparable results.").

⁵²⁰ 40 CFR 86.1869–12(b)—Credit available for certain off-cycle technologies.

⁵²¹ Unlike, for example, the statutory overcompliance credits prescribed in 49 U.S.C. 32903.

⁵²² 49 U.S.C. 32904(c)–(e). EPCA granted EPA authority to establish fuel economy testing and calculation procedures. See Section VII for more information.

⁵²³ 40 CFR 600.510–12(c).

⁵²⁴ See 40 CFR 86.1869–12(b). The TSD for the 2012 final rule for MYs 2017 and beyond provides technology examples and guidance with respect to the potential pathways to achieve the desired physical impact of a specific off-cycle technology from the menu and provides the foundation for the analysis justifying the credits provided by the menu. The expectation is that manufacturers will use the information in the TSD to design and implement off-cycle technologies that meet or exceed those expectations in order to achieve the real-world benefits of off-cycle technologies from the menu.

⁵²⁵ See 40 CFR 86.1869–12(c). EPA proposed a correction for the 5-cycle pathway in a separate technical amendments rulemaking. See 83 FR 49344 (Oct. 1, 2019). EPA is not approving credits based on the 5-cycle pathway pending the finalization of the technical amendments rule.

⁵²⁶ See 40 CFR 86.1869–12(d).

⁵²⁷ See 77 FR 62832, 62839 (Oct. 15, 2012). EPA introduced AC and off-cycle technology credits for the CO₂ program in the MYs 2012–2016 rule (75 FR 25324, May 7, 2010) and revised the program in the MY 2017–2025 rule (77 FR 62624, Oct. 15, 2012) and NHTSA adopted equivalent provisions for MYs 2017 and later in the MY 2017–2025 rule.

⁵²⁸ Vehicle and Engine Certification. Compliance Information for Light-Duty Gas (GHG) Standards. Compliance Information for Light-Duty Greenhouse Gas (GHG) Standards | Certification and Compliance for Vehicles and Engines | U.S. EPA. Last accessed December 22, 2021.

⁵²⁹ See 2021 EPA Automotive Trends Report, at 90 and 92.

model/configurations in the MY 2020 fleet. To account for the AC and off-cycle technologies equipped on vehicles and the potential that manufacturers will apply additional AC and off-cycle technologies in the rulemaking timeframe, we specify CAFE Model inputs for AC efficiency and off-cycle FCIVs in grams/mile for each manufacturer's fleet in each model year. We estimate future potential AC efficiency and off-cycle technology application in the CAFE analyses based on an expectation that manufacturers already relying heavily on these adjustments would continue to do so, and that other manufacturers would, over time, also approach the limits on adjustments allowed for such improvements.

The next sections discuss how the CAFE Model simulates the effectiveness and cost for AC efficiency and off-cycle technology adjustments.

(a) AC and Off-Cycle Effectiveness Modeling in the CAFE Model

In this analysis, the CAFE Model applies AC and off-cycle flexibilities to manufacturer's CAFE regulatory fleet performance in a similar way to the regulation.⁵³⁰ As the CAFE Model simulates the addition of technology to vehicles in a given model year fleet, the model first applies conventional technologies to vehicles in an attempt to meet a given standard, and then applies AC efficiency and off-cycle FCIVs to each regulatory fleet. In other words, first the CAFE Model applies conventional technologies to each manufacturer's vehicles in each model year to assess the 2-cycle sales weighted harmonic average CAFE rating. Then, the CAFE Model assesses the CAFE

rating to use for a manufacturer's compliance value after applying the AC efficiency and off-cycle FCIVs designated in the Market Data file. The CAFE Model does this on a year-by-year basis. The CAFE Model attempts to apply technologies and FCIVs in a way that both minimizes cost and allows the manufacturer to meet their standards without over or under complying.

To determine how manufacturers might adopt AC efficiency and off-cycle technologies in the rulemaking timeframe, we use data from EPA's 2021 Trends Report for MY 2020 and CBI compliance material from manufacturers.^{531 532} We use manufacturer's MY 2020 AC efficiency and off-cycle FCIVs as a starting point, and then extrapolate values in each model year until MY 2026, for light trucks to the proposed regulatory cap, for each manufacturer's fleets by regulatory class.

To determine the rate at which to extrapolate the addition of AC and off-cycle technology adoption for each manufacturer, we use historic AC and off-cycle technology applications, each manufacturer's fleet composition (*i.e.*, breakdown between passenger cars (PCs) and light trucks (LTs)), availability of AC and off-cycle technologies that manufacturers could still use, and CBI compliance data. Different manufacturers show different levels of historical AC efficiency and off-cycle technology adoption; therefore, different manufacturers hit the proposed regulatory caps for AC efficiency technology for both their PC and LT fleets, and different manufacturers hit caps for off-cycle technologies in the LT regulatory class. We do not extrapolate off-cycle technology adoption for PCs to

the proposed regulatory cap for a few reasons. First, past EPA Trends Reports showed that many manufacturers did not adopt off-cycle technology to their passenger car fleets. Next, manufacturers limited PC offerings in MY 2020 as compared to historical trends. Last, available CBI compliance data indicated that PCs adopt a lower level of menu item off-cycle technologies than LTs. We accordingly limit the application of off-cycle FCIVs to 10 g/mi for PCs but allow LTs to apply 15 g/mi of off-cycle FCIVs starting in MY 2023 for the final rule analysis. This decision also aligns with EPA's treatment of off-cycle adjustments in its final rule. The inputs for AC efficiency technologies are set to 5 g/mi and 7.2 g/mi for PCs and LTs, respectively. We allow AC efficiency technologies to reach the regulatory caps by MY 2024, which is the first year of standards assessed in this analysis.

We apply FCIVs in this way because the AC and off-cycle technologies are generally more cost-effective than other technologies. The details of this assessment (and the calculation) are further discussed in the CAFE Model Documentation.⁵³³ The AC efficiency and off-cycle adjustment schedules used in this analysis are shown in TSD Chapter 3.8 and in the Market Data file's Credits and Adjustments worksheet. Like the NPRM, for this final rule analysis we did not allow some manufacturers to reach the AC efficiency and off-cycle caps to avoid over compliance in the rulemaking time frame. Table III-34 and Table III-35 show the average FCIVs applied to the regulatory fleets for the final rule analysis.

Table III-34 – Passenger Car Average Fleet Values Used for Final Rule Analysis

Average Fleet Values	Passenger Car						
	2020	2021	2022	2023	2024	2025	2026
AC Efficiency (g/mile)	4.2	4.3	4.6	4.8	5.0	5.0	5.0
AC Leakage (g/mile)	11.3	11.6	12.1	12.7	13.1	13.5	13.6
Off-Cycle (g/mile)	4.8	5.0	5.4	5.8	6.3	6.9	7.2

⁵³⁰ 49 CFR 531.6 and 49 CFR 533.6 Measurement and Calculation procedures.

⁵³¹ Vehicle and Engine Certification. Compliance Information for Light-Duty Gas (GHG) Standards.

Compliance Information for Light-Duty Greenhouse Gas (GHG) Standards | Certification and Compliance for Vehicles and Engines | U.S. EPA. Last accessed May 24, 2021.

⁵³² 49 U.S.C. 32907.

⁵³³ CAFE Model Documentation, S5.

Table III-35 – Light Trucks Average Fleet Values used for Final Rule Analysis

Average Fleet Values	Light Truck						
	2020	2021	2022	2023	2024	2025	2026
AC Efficiency (g/mile)	5.84	6.18	6.48	6.84	6.96	7.06	7.18
AC Leakage (g/mile)	13.4	13.5	14	14.5	15.1	15.7	16.1
Off-Cycle (g/mile)	8.9	9.3	9.7	10.3	11	11.7	12.3

We received limited comments on how we model off-cycle and AC efficiency for this rulemaking analysis. Auto Innovators stated that “due to the static nature of the forecasts and input structure, the NHTSA forecasts on the quantity of off-cycle credits do not vary by scenario, and this creates material distortions in the model outputs. For instance, the projected Central case adoption of off-cycle technologies may contribute to over-compliance with some scenarios, especially low stringency scenarios.”⁵³⁴ On the other hand, UCS stated that “NHTSA has not acknowledge that its [CAFE Model] does not consider increased adoption of off-cycle technology to yield any real-world benefit . . . there is supportive evidence of their real-world benefits, and at any rate NHTSA must state explicitly its rationale for excluding these technologies from the benefits of the rule, as the credits associated with these technologies represent a substantial share of the credits accrued for compliance by manufacturers.” UCS also stated that “NHTSA should correct the [CAFE Model] to ensure it adjusts a vehicle’s fuel economy to account for reductions in emissions and fuel use from off-cycle technologies, which will yield a more accurate accounting of the benefits from the CAFE program.”⁵³⁵

In response to comments from Auto Innovators, we agree that, in theory, the way the CAFE Model is set up to apply off-cycle benefits statically could create overcompliance for some manufacturers. However, as discussed earlier and in TSD Chapter 3.8, we apply off-cycle and other flexibilities differently for each manufacturer rather

than apply adjustments consistently to the cap for each manufacturer. For example, if a manufacturer is on a trajectory to reach the off-cycle regulatory cap, then we allow the model to reach that cap regardless of alternatives. On the other hand, if a manufacturer has historically lagged in the adoption of off-cycle technology, we use this historic rate of application through the rulemaking time frame. As shown in Table III–34 and Table III–35, on average, the fleet does not reach the regulatory caps based on our extrapolation.

We understand UCS’s concern, that because the CAFE Model accounts for off-cycle technology at the fleet level, the benefits do not directly appear in the vehicle-level benefits analysis. Although further refinement may be possible for future analyses, at this time there are only limited vehicle-level data available. We agree that some manufacturers have relied on these flexibilities more so than others, but as indicated by the 2021 EPA Trends Report many are still lagging in adopting these technologies.⁵³⁶ This is one reason why we declined to apply off-cycle benefits up to the cap for each vehicle to have those benefits automatically count in the benefits calculations. Based on the ratio of benefits that manufacturers can expect from on-cycle versus off-cycle technology, we believe that the small off-cycle technology benefit that is not accounted for in the benefits calculations does not make a material difference to the analysis.

For the final rule analysis, we updated the baseline fleet off-cycle data

to reflect the 2021 EPA Trends Report, using the same modeling methodology as the NPRM. We believe that this approach is appropriate to capture the costs and benefits of off-cycle technologies.

(b) AC and Off-Cycle Costs

For this analysis, AC and off-cycle technologies are applied independently of the decision trees using the extrapolated values shown above, so it is necessary to account for the costs of those technologies independently. Table III–36 shows the costs used for AC and off-cycle FCIVs in this analysis. The costs are shown in dollars per gram of CO₂ per mile (\$ per g/mile). The AC efficiency and off-cycle technology costs are the same costs used in the EPA Proposed Determination and described in the EPA Proposed Determination TSD.⁵³⁷

To develop the off-cycle technology costs, we selected the second generic 3 g/mile package estimated to cost \$170 (in 2015\$) to apply in this analysis in \$ per g/mile. We updated the costs used in the Proposed Determination TSD from 2015\$ to 2018\$, adjusted the costs for RPE, and applied a relatively flat learning rate.

Similar to off-cycle technology costs, we used the cost estimates from EPA Proposed Determination TSD for AC efficiency technologies that relied on the 2012 rulemaking TSD.⁵³⁸ We updated these costs to 2018\$ and adjusted for RPE for this analysis and applied the same mature learning rate that we had applied for off-cycle technologies.

⁵³⁴ Auto Innovators, Docket No. NHTSA–2021–0053–0021 Appendix VII, at 125–126.

⁵³⁵ UCS, Docket No. NHTSA–2021–0053–1567, at 31.

⁵³⁶ 2021 EPA Trends Report at 104–106.

⁵³⁷ EPA PD TSD, EPA–420–R–16–021, November 2016, at 2–423–2–245. <https://nepis.epa.gov/Exe/>

[ZyPDF.cgi?Dockey=P100Q3L4.pdf](#). Last accessed May 24, 2021.

⁵³⁸ Joint NHTSA and EPA 2012 TSD, see Section 5.1.

Table III-36 – Estimated Costs (\$ per g/mi) for AC and Off-Cycle Adjustments

Model Year	AC Efficiency	AC Leakage	Off-Cycle
2020	4.30	10.76	83.79
2025	3.89	9.72	77.47
2030	3.52	8.79	71.83

In the NPRM we sought comment on whether our costs were appropriate or if other costs should be used. Overall, comments from UCS, Consumer Reports, and ICCT stated that our costs for off-cycle technologies were high.⁵³⁹ Consumer Reports indicated that they did not investigate the NHTSA approach to AC and off-cycle adjustments and costs. However Consumer Reports did find “that under the EPA proposal the use of similar costs for off-cycle technologies resulted in compliance costs for those technologies that were more than three times the average compliance costs of all the technology applied to achieve the Preferred Alternative.”⁵⁴⁰ ICCT stated that “the agencies use an arbitrarily and unrealistically high estimate of off-cycle credit cost in their compliance modeling.”⁵⁴¹ UCS conducted an analysis of off-cycle costs using the 2020 final rule’s CAFE Model and data from the 2021 NAS Report to show that the average costs could be different if the agencies used different inputs.⁵⁴² This approach is similar to the one used by EPA in the final rule for MYs 2023–2026 in determining the costs of off-cycle.

As we discussed in the NPRM and explained again above, the CAFE Model was updated from the 2020 final rule model to better account for costs of AC and Off-Cycle technologies.^{543 544} This update fixed many of the issues highlighted by the commenters by baking in the costs per vehicle of the off-cycle technology in the baseline vehicle and excluding the costs from affecting the new vehicle model output costs. The CAFE Model used by EPA in their rulemaking analysis for MYs 2023–2026 did not have this feature, and they were required to re-evaluate the costs as

described in the EPA Regulatory Impacts Analysis.⁵⁴⁵

Separately, none of these commenters provided alternative AC and off-cycle technology costs in response to our request that commenters provide any data or information on which any alternative costs are based on. General statements that costs should be lower, without specific data and analysis to support those statements, are not enough to justify a change from the NPRM values. As one example, the 2021 NAS Report observed an AC efficiency technology similar to one used by Toyota, and they estimated the cost of that technology to be \$170 in 2025.^{546 547} However, that was not enough information for us to update our gram per mile cost for all technologies. We will continue to research this issue for future analyses.

E. Consumer Responses to Manufacturer Compliance Strategies

The previous subsections in Section III have so far discussed how manufacturers might respond to changes to the standards. While the technology analysis is informative of the different compliance strategies available to manufactures, the tangible costs and benefits that accrue because of CAFE standards also depend on how consumers respond to the decisions made by manufacturers. Many of the benefits and costs resulting from changes to CAFE standards are private benefits that accrue to the buyers of new cars and trucks produced in the model years subject to this rulemaking. These benefits and costs largely flow from the changes to vehicle purchases, ownership, and operating costs that result from improved fuel economy, as well as from the costs of the technology required to achieve those improvements. In addition, buyers’ and owners’ decisions about the use of their vehicles can impose costs or create

benefits that fall on others, which the agency refers to as “external” costs or benefits. The following subsections describe how NHTSA’s analyzes consumer responses to changing vehicles and prices.

1. Assumptions About Macroeconomic Conditions and Consumer Behavior

This final rule includes a comprehensive economic analysis of the impacts of establishing more stringent CAFE standards, and most of the effects it measures are influenced by future macroeconomic conditions that are beyond the agency’s influence. For example, domestic fuel prices are mainly determined by global petroleum supply and demand as well as refining costs, yet they determine how much technology manufacturers will employ to improve the fuel economy of cars and light trucks produced for the U.S. market, how much consumers are willing to pay for new vehicles offering different levels of fuel economy, how much new and used cars and light trucks will be driven, and the value of each gallon saved through higher CAFE standards. Similarly, projecting sales of new cars and light trucks produced during the model years subject to the standards this final rule establishes requires robust projections of demographic and macroeconomic variables that span the entire timeframe of the analysis, including U.S. population, Gross Domestic Product (GDP), consumer confidence about future economic conditions, and disposable personal income.

To ensure internal consistency within the agency’s analysis, projections of most of the economic variables used in our analysis are obtained from the same source. The analysis presented here relies on forecasts of fuel prices issued by the U.S. Energy Information Administration (EIA), an agency within the DOE that collects, analyzes, and disseminates independent and impartial energy data and forecasts to promote sound policymaking, efficient markets, and public understanding of energy and its interaction with the economy and the environment. EIA uses its National Energy Model System (NEMS) to produce its Annual Energy Outlook

⁵³⁹ Consumer Reports, Docket No. NHTSA–2021–0053–1576, at 22; UCS, at 30; ICCT, Docket No. NHTSA–2021–0053–1581, at 8.

⁵⁴⁰ Consumer Reports, at 22–23.

⁵⁴¹ ICCT, at 8.

⁵⁴² UCS, at 30.

⁵⁴³ 86 FR 49605 (Sept. 3, 2021).

⁵⁴⁴ “More accurate accounting for off-cycle incremental costs relative to MY 2020 baseline fleet.”

⁵⁴⁵ EPA Final Rule for MYs 2023–2026 RIA, Chapter 4.1.1.1, Off-Cycle Credit Cost and changes since the Proposed Rule, at p. 4–6.

⁵⁴⁶ 2021 NAS Report, at 68.

⁵⁴⁷ EPA Decision Document. “Off-Cycle Credits for Toyota Motor North America.” EPA–420–R–21–024. October 2021. <https://nepis.epa.gov/Exec/QueryPDF.cgi?Dockey=P1013CFE.pdf>. (Accessed: March 15, 2022)

(AEO), which includes forecasts of future U.S. macroeconomic growth and fuel prices among many other energy-related variables. NHTSA's main analysis uses forecasts of fuel prices, from the AEO 2021 Reference Case. The agency also uses forecasts of the U.S. population, the number of U.S. households, the Nation's Gross Domestic product (GDP), disposable personal income, and consumer confidence to develop its projections of new car and light truck sales as well as of total light-duty vehicle travel. For the current analysis, NHTSA obtained forecasts of these variables from the IHS Markit Global Insight October 2021 Macroeconomic Outlook base case, which represents the most likely scenario from that organization's most current forecast. EIA also relies on the IHS Markit Global Insight Macroeconomic Outlook to develop the macroeconomic and energy price forecasts included as part of its Annual Energy Outlook. However, the forecasts EIA presents in its Annual Energy Outlook 2021 are based on the IHS Markit Global Insight March 2021 Macroeconomic Outlook, rather than the more recent October 2021 Outlook the agency relies on in this analysis. Because the forecasts of population, GDP, disposable income, and other variables in the March 2021 and October 2021 Macroeconomic Outlooks are very similar, the forecasts the agency relies on in this analysis are generally consistent with those reported in EIA's AEO 2021. TSD Chapter 4.1 includes a more complete discussion of the macroeconomic assumptions made for the analysis.

While these macroeconomic assumptions are some of the most critical inputs to the analysis, they are also subject to the most uncertainty—particularly over the lifetimes of the vehicles subject to this final rule, which can extend as far as forty years into the future. The agency also uses low and high economic growth and global oil price forecasts issued by EIA as part of its Annual Energy Outlook as alternative cases in its sensitivity analyses. The purpose of these sensitivity analyses, which are discussed in greater detail in FRIA Chapters 6 and 7, is not to posit a more credible future state of the world than the central case, which the agency assumes represents the most likely future state of the world. Instead, the sensitivity analyses are intended to illustrate the degree to which important future outcomes resulting from this final rule might change under different assumptions about fuel prices, economic growth, and other factors.

The agency received several comments about the macroeconomic assumptions used in the analysis. Auto Innovators correctly noted that fuel prices will influence the adoption of advanced technologies and the cost and benefits realized under the new standards, and commented that EIA's projections may overestimate fuel prices. In support of its claim, Auto Innovators notes that EIA's projections have historically overestimated fuel prices and speculates that the current forecasts could overestimate domestic demand if the "EIA Central Case gasoline forecast assumes fewer than 50 [percent] plug-in vehicles by 2030."⁵⁴⁸ In that event, Auto Innovators recommended that NHTSA instead rely on the IHS Markit Global Insight forecast of fuel prices throughout its main analysis, which as its comment showed falls considerably below the AEO 2021 Reference Case forecast after about the year 2030. Auto Innovators recognized that NHTSA does use the Global Insight forecast it recommended for the purpose of sensitivity analysis but encouraged the agency to feature it more prominently.

In contrast, Consumer Reports asserted that the AEO 2021 projections underestimated how quickly fuel prices would rebound from the diminished demand caused by onset of COVID-19. Consumer Reports suggested that the agency use the AEO 2020 reference case instead of that from AEO 2021 to avoid the potential for fuel prices from calendar year 2020 to unduly influence the rest of the analysis.⁵⁴⁹ As discussed earlier, projections are inherently uncertain and actual prices are likely to deviate from those forecast for any given future year, and the accuracy of a multi-year forecast should not be judged by its ability to predict the value realized in a single period. In any case, the agency determined that the AEO 2021 projections of fuel prices were more appropriate for this analysis, because they incorporate the potential long-term impacts of the COVID-19 pandemic and its effects on travel activity, gasoline demand, and future fuel prices.⁵⁵⁰

⁵⁴⁸ Auto Innovators, Docket No. NHTSA-2021-0053-0021, at 58-59. The AEO 2021 Reference Case forecasts that less than 2 percent of new car and light truck sales during 2030 will be plug-in hybrid models and including projected sales of conventional hybrid models increases that figure to somewhat more than 6 percent.

⁵⁴⁹ Consumer Reports, Comment Body, Docket No. NHTSA-2021-0053-1576, at 23.

⁵⁵⁰ EIA reports that actual retail gasoline prices during 2021 averaged \$3.10 per gallon, considerably higher than the \$2.36 average price projected for 2021 as part of AEO 2021. While part of this discrepancy probably owes to an overly cautious view of how rapidly global demand for petroleum

Commenters also raised concerns about the included electricity price forecast. Auto Innovators, for example, proposed electricity rate inputs are too low in the face of anticipated increases in renewable electricity generation and may therefore overestimate benefits of the regulatory action.⁵⁵¹ The commenters pointed to research from the National Renewable Energy Laboratory that suggests price increases are possible and noted EPA's fuel price inputs increase to \$0.133 per kWh in 2040 (compared to \$0.120 in the NHTSA's NPRM). Auto Innovators did not suggest alternative price series and NHTSA is wary of varying fuel prices without simultaneously varying assumptions about electricity grid mix. Further, the CAFE Model is unable to simulate regional differences in electricity generation and fuel prices and cannot capture regional differences in electricity prices, which may arise from heterogeneity in grid mix. The agency did include a sensitivity case that varied projections about electricity supply and included a case with high levels of renewable energy generation from EIA. These results are included in FRIA Chapter 7.

Another key assumption that has important ramifications throughout the agency's analysis is how much consumers are willing to pay for improved fuel economy. If buyers fully value the savings in fuel costs that result from driving (and potentially re-selling) vehicles with higher fuel economy and manufacturers supply all improvements in fuel economy that buyers demand, market-determined levels of fuel economy would reflect both the cost of improving it and the private benefits from doing so.⁵⁵² In that case, regulations on fuel economy would only be necessary to reflect environmental or other benefits other than to buyers themselves. But if consumers instead undervalue future fuel savings or are otherwise unable to purchase their optimal levels of fuel economy due to market failures, they will underinvest in fuel economy and manufacturers would spend too little on fuel-saving technology (or deploy its energy-saving benefits to improve vehicles' other

products would return to its pre-pandemic level, other unforeseen factors apparently contributed as well. This is evidenced by the fact that actual gasoline prices during 2021 were well above their levels during the pre-pandemic years of 2018 and 2019, when they averaged \$2.81 and \$2.69 per gallon.

⁵⁵¹ Auto Innovators, A1, at 85.

⁵⁵² Besides fuel savings, the private benefits from increased fuel economy may also include increased driving range, decreased costs per mile driven, and refueling benefits such as the experience of not having to stop as often to refuel.

attributes). In that case, more stringent fuel economy standards could lead manufacturers to adopt improvements in fuel economy that not only reduce external costs from producing and consuming fuel to appropriate levels but also improve consumer welfare.

Increased fuel efficiency offers vehicle owners significant potential savings; in fact, our analysis shows that the value of prospective fuel savings exceeds manufacturers' technology costs to comply with even the most stringent standards considered for this final rule when both are discounted at a either a 3 percent or 7 percent rate. It would seem reasonable to assume that well-informed vehicle shoppers, if without time constraints or other barriers to rational decision-making, will recognize the full value of fuel savings from purchasing a model that offers higher fuel economy, since they would enjoy an equivalent increase in their disposable income and the other consumption opportunities it affords them. If consumers did value the full amount of fuel savings, more fuel-efficient vehicles would functionally be less costly for consumers to own when considering both their initial purchase prices and subsequent operating costs, thus making the models that manufacturers are likely to offer under stricter alternatives more attractive than those available under the No-Action Alternative.

Recent econometric research is divided between studies concluding that consumers value most or all of the potential savings in fuel costs from driving higher-mpg vehicles, and those concluding that consumers significantly undervalue expected fuel savings. Based on a detailed analysis of changes in recent sale values of cars and light trucks in response to variation in fuel prices, Busse et al. (2013) estimated that buyers value 54 to 117 percent of fuel savings from purchasing higher-mpg models, with the exact value depending on the discount rate they apply to future savings; their estimates for new car buyers ranged from 75 to 133 percent of future fuel savings. Using similar methods and an extremely large sample of used vehicle sales, Allcott and Wozny (2014) estimated a corresponding range of 55 to 76 percent depending on their assumptions about buyers' discount rates and expectations for future fuel prices, with a figure of 93 percent for buyers of the newest (1–3 year old) cars in their sample. Again using similar methods, Sallee et al. (2016) estimated that car and light truck buyers are willing to pay from 60 percent to perhaps as much as 142 percent of the value of future fuel savings to purchase

models offering higher fuel economy. Most recently, Leard and Zhou's (2021) analysis puts the most likely value for this figure at slightly above half (54 percent), and Gillingham et al. (2021) find that "consumers systematically undervalue fuel economy in vehicle purchases to a larger degree than reported by much of the recent literature."^{553 554}

More circumstantial evidence appears to show that consumers do not fully value the expected lifetime fuel savings from purchasing higher-mpg models. Although the average fuel economy of new vehicles reached an all-time high of 25.7 MPG in MY 2020, this is still significantly below the fuel economy of the fleet's most efficient vehicles that are readily available for consumers to purchase.^{555 556} Manufacturers have repeatedly informed the agency that consumers value only 2 to 3 years of the future fuel savings that higher-mpg cars and light trucks offer when choosing among available models.

The potential for car buyers to voluntarily forgo improvements in fuel

⁵⁵³ Busse, M., C. Knittel, and F. Zettelmeyer. 2013. "Are Consumers Myopic? Evidence from New and Used Car Purchases." *American Economic Review* 103(1): 220–56; Allcott, H., and N. Wozny. 2014. "Gasoline Prices, Fuel Economy, and the Energy Paradox." *The Review of Economics and Statistics* 96(5): 779–95; Sallee, J., J. West, and W. Fan. 2016. "Do Consumers Recognize the Value of Fuel Economy? Evidence from Used Car Prices and Gasoline Price Fluctuations." *Journal of Public Economics* 135: 61–73; Leard, B., J. Linn, and Y. Zhou. 2021. "How Much Do Consumers Value Fuel Economy and Performance? Evidence from Technology Adoption." *The Review of Economics and Statistics*: 1–45 (forthcoming); Gillingham, K.T., S. Houde, and A. van Bentham, 2021. "Consumer Myopia in Vehicle Purchases: Evidence from a Natural Experiment." *American Economic Journal: Economic Policy* 13(3): 207–238.

⁵⁵⁴ Other research asks the more fundamental questions of whether consumers are adequately informed about and attentive to potential fuel savings from buying higher-mpg models when they shop for new cars, and again arrives at mixed conclusions. This includes Allcott, H. and C. Knittel, 2019. "Are Consumers Poorly Informed about Fuel Economy? Evidence from Two Experiments", *AEJ: Economic Policy*, 11(1): 1–37, and D. Duncan, A. Ku, A. Julian, S. Carley, S. Siddiki, N. Zirogiannis and J. Graham, 2019. "Most Consumers Don't Buy Hybrids: Is Rational Choice a Sufficient Explanation?", *J. of Benefit-Cost Analysis*, 10(1): 1–38. The former analysis concludes that consumers appear to be relatively well-informed about the value of higher fuel economy when they shop for new vehicles, while the latter concludes that some buyers appear inattentive to savings available from buying higher-MPG hybrid versions of certain vehicle models.

⁵⁵⁵ See EPA 2020 Automotive Trends Report at 6 and 9, available at <https://nepis.epa.gov/Exe/ZyPDF.cgi?Dockey=P1010U68.pdf>. (Accessed: March 15, 2022)

⁵⁵⁶ Of course, this could simply suggest that the future savings in fuel costs those models offer—given potential buyers' expectations about future fuel prices—do not justify manufacturers' costs for providing them, since those are presumably reflected in their higher purchase prices.

economy that appear to offer future savings exceeding their initial costs is one example of what is often termed the "energy-efficiency gap." The appearance of a gap between the level of energy efficiency that would minimize consumers' overall expenses and what they actually purchase is typically based on engineering calculations that compare the initial cost for providing higher energy efficiency to the discounted present value of the resulting savings in future energy costs. There has long been an active debate about why such a gap might arise and whether it exists. Economic theory predicts that economically rational individuals will purchase more energy-efficient products only if the savings in future energy costs they offer promise to offset their higher initial costs. On the other hand, various market failures, including information asymmetries between consumers, dealerships, and manufacturers; market power; first-mover disadvantages for both consumers and manufacturers; split incentives between vehicle purchasers and vehicle drivers; and other failures may prevent consumers from purchasing the optimal level of fuel economy in an unregulated market. Furthermore, behavioral economics has documented numerous situations in which the decision-making of consumers differs in important ways from the predictions of the model of the fully optimizing consumer (e.g., Dellavigna, 2009).⁵⁵⁷

One explanation for such 'undervaluation' of the savings from purchasing higher-mpg models is myopia or present bias, where consumers focus unduly on short-term costs while giving insufficient attention to long-term benefits.⁵⁵⁸ This situation could arise because buyers are unsure whether they will actually realize the fuel savings indicated by test data posted on cars' fuel economy labels under the conditions where they drive, what future fuel prices will be, how long they will own a new vehicle, or whether they will drive it enough to realize the promised savings. As a consequence, they may view choosing

⁵⁵⁷ Dellavigna, S., 2009. "Psychology and economics: Evidence from the field," *Journal of Economic Literature*, 47(2), 315–372. Available at <https://pubs.aeaweb.org/doi/pdfplus/10.1257/jel.47.2.315>. (Accessed: Mar. 24, 2022).

⁵⁵⁸ Gillingham et al., 2021, which is an AEJ: Economic Policy paper, just published on consumer myopia in vehicle purchases; a standard reference on present bias generally is O'Donoghue, Ted, and Matthew Rabin. 2015. "Present Bias: Lessons Learned and To Be Learned." *American Economic Review: Papers & Proceedings* 105(5): 273–79. Available at <https://pubs.aeaweb.org/doi/pdfplus/10.1257/aer.p20151085>. (Accessed: Mar. 30, 2022).

to purchase a more fuel-efficient vehicle as a risky “bet,” and experimental research has shown that when faced with a risky choice, some consumers appear to weigh the potential loss from an adverse outcome approximately twice as heavily as the potential gain from “winning” the bet, leading them to significantly undervalue that choice relative to its probabilistic “expected” value (e.g., Kahneman and Tversky, 1979;⁵⁵⁹ Kahneman, 2011).⁵⁶⁰ Viewed in the context of a choice to pay more for a higher-mpg car, loss aversion has been shown to have the potential to cause undervaluation of future fuel savings like that reported by manufacturers (Greene, 2011;⁵⁶¹ Greene et al., 2013).⁵⁶²

The “behavioral” model of consumer choice also holds that consumers’ decisions are affected by the context of choices and its effect on how consumers “frame” decisions. From this perspective, it is possible that consumers respond to changes in the fuel economy new vehicles offer required by government regulations such as CAFE standards differently than they respond to manufacturers voluntarily offering buyers the option to purchase models featuring the same fuel economy levels those regulations would require.⁵⁶³ The intuition behind this possibility is that if a consumer is shopping for a new car in an unregulated market and considering two models—one that offers higher fuel economy but is more expensive and another that does not but is cheaper—she may buy the less fuel efficient version even if choosing the more expensive model could save money in the long run. If instead the consumer faced the decision to buy a new car or keep an older one, and all new car models were required to meet fuel economy standards, she may view the decision differently and elect to purchase a new model offering the same

price and fuel economy that she previously declined to purchase. Further, if fuel economy standards increased gradually over a period of years, this would allow time for consumers to consult other information sources and verify that potential fuel savings are likely to prove real and of substantial value.

Another alternative explanation for consumers’ reluctance to purchase more costly models whose lower fuel costs would ultimately repay their higher purchase prices is that consumers view those higher prices in the context of tradeoffs they make among their purchasing decisions. Households must choose how to spread their limited incomes over many competing goods and services, including deciding how much to spend on a new vehicle, or even whether to opt for another form of transportation instead. While a consumer may correctly recognize the cumulative long-term value of fuel savings, they may also prefer to spend the extra cost of buying a car that offers those savings on other items, whether other vehicle attributes—more interior space and comfort, for example, or a more luxurious trim package—or on other unrelated goods and services. Some of the same technologies that manufacturers have available to increase fuel economy can also enable increased vehicle size, power, or weight while maintaining fuel economy.⁵⁶⁴ While increased fuel efficiency will free up disposable income throughout the lifetime of the vehicle (and may ultimately exceed the additional upfront costs to purchase a more expensive but more fuel-efficient vehicle), the value of owning a different good sooner may provide consumers with even more benefit.⁵⁶⁵

NHTSA’s NPRM included an extensive theoretical discussion of consumer valuation of fuel economy, including a detailed theoretical analysis of consumer choices between vehicle performance and fuel economy when buyers are constrained by limited budgets and manufacturers by fuel economy standards. That analysis showed that when fuel economy standards are binding, consumers might

prefer that manufacturers employ newly available technologies that could be used to improve performance or increase fuel economy to improve performance, and that manufacturers would be likely to do so. NHTSA’s analysis also suggested that if fuel economy standards no longer constrained consumers’ choices, due either to shifting preferences for fuel economy (for example, in response to changes in the price of gasoline) or to changes in buyers’ income levels, manufacturers would be likely to use new technologies to improve both performance and fuel economy. NHTSA then presented trends in new vehicle fuel economy and performance over time and suggested that its theoretical analysis was consistent with the historical record, which shows the fuel economy of the new vehicle fleet increases when the price of gasoline increases.⁵⁶⁶ NHTSA solicited comments on its theoretical analysis and the potential implications for its FRIA, and also sought potential approaches for valuing the tradeoff between performance and fuel economy when NHTSA’s standards constrain consumers to choose more fuel-efficient options.

NHTSA noted in the NPRM that the substantial literature on the topic of consumer valuation of fuel economy is approximately evenly divided between studies that suggest consumer undervalue fuel economy and studies that support valuation at the full discounted present value (no undervaluation). This potential undervaluation, frequently referred to as the “energy paradox” or “fuel efficiency gap,” has prompted an extensive exploration of potential behavioral explanations why consumers might undervalue fuel economy. NHTSA explored the possibility that the context and framing around consumer decisions may influence consumer choices—and that consumers may value fuel-saving technology differently when their choices are constrained to more fuel-efficient options. NHTSA also discussed how the value consumers place on fuel economy may change over time, and that they may come to value the future stream of fuel savings more once they begin to experience those savings when the rule is in place. NHTSA noted that if fuel economy standards lead consumers to value fuel economy more once they experience a savings, the new higher valuation of fuel economy may offset some or all of the negative impact

⁵⁵⁹ Kahneman, D. and A. Tversky, 1979. “Prospect theory: An analysis of decision making under risk,” *Econometrica*, 47, 263–291.

⁵⁶⁰ Kahneman, D., 2011. *Thinking Fast and Slow*. Farrar, Straus and Giroux, New York.

⁵⁶¹ Greene, D.L., 2011. “Uncertainty, Loss Aversion and Markets for Energy Efficiency,” *Energy Economics*, 33, 608–616.

⁵⁶² Greene, D.L., D.H. Evans, and J. Hiestand, 2013. “Survey evidence on the willingness of U.S. consumers to pay for automotive fuel economy,” *Energy Policy*, 61, 1539–1550. Application of investment under uncertainty will yield similar results as costs may be more certain and up front while the fuel savings or benefits of the investment may be perceived as more uncertain and farther into future, thereby reducing investments in fuel saving technologies.

⁵⁶³ See NASEM (2021), Ch. 11.3.3, We explain this potential differential response more thoroughly in TSD Chapter 4.2.1.1.

⁵⁶⁴ Other technologies may simultaneously increase both fuel economy and certain performance attributes.

⁵⁶⁵ While households have budgets, both individual vehicle purchasers and the purchasers of large fleets of vehicles may have access to financing for vehicle purchases. Given sufficient financing, a rational consumer could both purchase fuel economy improvements that will pay for themselves over time as well as other desired goods. Failure to do so would seem to indicate either a lack of efficient access to financing or some market failure.

⁵⁶⁶ For additional details, see 86 FR 49723–31 (Sept. 3, 2021).

on sales due to the higher prices of fuel-efficient vehicles.

As explained in more detail in TSD Chapter 4.2.1.1, the agency's analyses of the extent to which manufacturers will voluntarily improve fuel economy and of the response of new car and light truck sales to higher sales prices assume that potential buyers of new cars and light trucks value only the undiscounted savings in fuel costs they would expect to realize over the first 30 months they own a newly purchased vehicle. Depending on the discount rate buyers are assumed to apply, this amounts to 25–30 percent of the expected savings in fuel costs they (and any subsequent owners) would ultimately realize over the vehicle's entire expected lifetime. However, NHTSA establishes CAFE standards by comparing vehicles' *lifetime* savings in fuel costs and other economic benefits from reducing fuel consumption to manufacturers' costs to improve fuel economy, which leads the agency to set standards that require much higher levels of fuel economy than it assumes buyers are willing to pay for. Thus, the agency's analysis does assume that new car shoppers are somewhat myopic—and that an “energy paradox” exists in the case of fuel economy—but only at the time they are consider purchasing a new car or light truck, and that they ultimately value the lifetime fuel savings that purchasing a higher-mpg model provides.⁵⁶⁷ The agency also assumes that manufacturers' compliance costs will ultimately be borne by vehicle buyers in the form of higher purchase prices for new cars and light trucks. This means that the fraction of savings in future fuel costs buyers are assumed to take into account at the time of purchase (again, 25–30 percent) when choosing among models would offset only that same fraction of the expected increase in new car and light truck prices.

NHTSA sought comment on the length of time that should be used for this “payback period” assumption, and asked commenters to specify the length of time they believed it should span, provide an explanation of why that period is preferable to the agency's assumption, include reference to any data or information on which an alternative payback period is based, and discuss how changing this assumption

⁵⁶⁷ In addition to myopia, other market failures may also cause consumers to undervalue fuel savings at the time of purchase but still fully value the lifetime fuel savings they actually experience, including information asymmetries, split incentives, first-mover effects, and others. Moreover, it is appropriate in a social cost-benefit analysis to fully value the resource savings that will result from the purchase of vehicles with greater fuel economy.

would interact with other elements in the analysis. In response, NHTSA received a handful of comments on this apparent “energy efficiency gap” and the agency's assumption about consumers' willingness to pay. NADA and Auto Innovators agreed with the agency's assumption of a 30-month payback period, while stressing the need to account for the utility of other vehicle attributes that might be improved in the absence of mandates to provide higher fuel economy.⁵⁶⁸ NADA commented that consumers are not myopic, and any appearance that they are actually reflects their wide range of preferences for other vehicle attributes, which also explains their willingness to forgo some fuel savings in favor of improvements to vehicles' other features. NADA asserted that potential buyers of new cars and light trucks focus on the total lifetime cost of vehicle ownership, and by doing so consider the cost and value of purchasing models that offer higher levels of not just fuel economy, but other desirable features as well. To support its claim, NADA cited to data from the 2021 Strategic Vision New Vehicle Efficiency Survey that found fuel economy ranked as the 12th most important attribute to consumers. NADA argued that NHTSA needed to examine “actual sales and lease data or studies assessing how new light-duty vehicle consumers value fuel economy technology when making purchasing decisions,” and implored the agency to account for the “temporal shifting of consumer preferences.” Auto Innovators supported analyzing sensitivity cases with payback periods ranging from 1 to 4 years.⁵⁶⁹

EDF commented that the agency should assume a longer repayment period and cited as support a Consumer Reports study showing that 64 percent of consumers rank fuel economy as extremely or very important, and view fuel economy as “the number one attribute that has room for improvement.”⁵⁷⁰ NHTSA notes that the same Consumer Report study also polled consumers about how quickly fuel savings would have to offset higher vehicle purchase prices for them to be willing to pay for increased fuel efficiency. Responses to this question showed that the average consumer is willing to pay for only 2–3 years of fuel savings, which aligns well with the agency's estimate of 30 months, and that only 39 percent of consumers are

⁵⁶⁸ NADA, Docket No. NHTSA–2021–0053–1471, at 8–9.

⁵⁶⁹ Auto Innovators, at 83–84.

⁵⁷⁰ Environmental Defense Fund, Docket No. NHTSA–2021–0053–1617, at 5.

willing to pay for fuel economy improvements with a payback period longer than 3 years.⁵⁷¹

CBD et al. commented that the agency is underestimating consumers' willingness to pay by assuming that they require a 30-month payback period, but did not explain why it believes this is the case or suggest an alternative estimate.⁵⁷²

Institute for Policy Integrity at New York School of Law (IPI) urged the agency consider using different payback assumptions at different points throughout its analysis. Specifically, IPI commented that NHTSA should use a lower willingness to pay under the baseline scenario to determine how much manufacturers would voluntarily improve fuel economy in the absence of stricter standards, but should assume a higher willingness to pay when analyzing how the standards will affect sales of new vehicles and the turnover of the used vehicle fleet.⁵⁷³ IPI endorsed the possibility the agency raised in its proposal that CAFE regulations can ameliorate myopia among potential buyers or information asymmetries between vehicle manufacturers and buyers, and by doing so lead potential buyers to value a larger fraction of future fuel savings from choosing a higher-mpg model. IPI also listed other potential market failures that CAFE regulations could potentially mitigate.⁵⁷⁴

Specifically, IPI suggested that the agency use a 1.7-year payback period to identify the technologies manufacturers would adopt and to estimate the resulting increase in fuel economy under the baseline, but assume that actual buyers of new cars and light trucks would value fuel savings over the first 7 years of their lifetimes when evaluating whether to scrap a vehicle. Scrapage rates. However, IPI did not offer NHTSA a framework for implementing differing payback periods, or explain whether the difference in payback periods was intended to reflect manufacturers

⁵⁷¹ Consumer Reports, “Consumer Attitudes Towards Fuel Economy” 2020 Survey Results (Feb. 2021), page 5, <https://advocacy.consumerreports.org/wp-content/uploads/2021/02/National-Fuel-Economy-Survey-Report-Feb-2021-FINAL.pdf>. (Accessed: March 15, 2022).

⁵⁷² Center for Biological Diversity, Chesapeake Bay Foundation, Conservation Law Foundation, Earthjustice, Environmental Law & Policy Center, Natural Resources Defense Council, Public Citizen, Inc., Sierra Club, and Union of Concerned Scientists (NHTSA–2021–0053–1572) (CBD et al.), Joint Summary Comments, Docket No. NHTSA–2021–0053–1572, at 6.

⁵⁷³ IPI, Docket No. NHTSA–2021–0053–1579–A1, at 16–17.

⁵⁷⁴ See generally, *id.*, at 9–14.

underestimation of buyers' valuation of fuel economy and if so, why manufacturers would do so only under the No-Action Alternative. Nor did IPI specify how long after new standards were adopted would be required for consumers to begin to value additional fuel economy, or why they would revert to their original lower valuation once new standards took effect and became the baseline for evaluating further increases. IPI also commented that if the agency opted not to use differing payback assumptions, then the agency should use a shorter payback period (1.7 years) throughout the analysis to avoid overestimating overcompliance in the baseline,⁵⁷⁵ and suggested that the agency conduct expert elicitation to derive a better estimate.⁵⁷⁶

IPI also commented that NHTSA's theoretical analysis of constrained consumer choice lacked an empirical test of its validity and that other explanations for the historical pattern of increases in fuel economy and changes to vehicles' other attributes may be more plausible than that offered by the agency. IPI also argued that consumers' choices involving higher-mpg models cannot be constrained by their budgets because fuel savings compensate consumers for paying the higher upfront costs (thus enabling buyers to finance those additional costs). IPI argued further that failures in the market for auto financing that make consumers unable to obtain favorable financing to purchase more fuel-efficient vehicles may constrain consumers' choices more than any budgetary limits. IPI continued that NHTSA's prior estimates of the opportunity cost of other vehicle attributes lacked an empirical basis and ignored potential countervailing effects such as reduced compliance costs.

In contrast, NADA commented that a consumer's willingness to purchase fuel-economy technology must be viewed in the context of losses in other vehicle attributes like power or safety, and argued that consumers are not myopic. In support of its position, NADA cited Leard et al.'s (2021) finding that consumers undervalue fuel economy but place high values on performance and other attributes,⁵⁷⁷ as well as Klier and Linn's (2016) finding that tighter vehicle standards reduce horsepower and torque relative to their

levels where standards remain unchanged.⁵⁷⁸ Finally, IPI cited the conclusion of EPA's Scientific Advisory Board that it found little "useful consensus" on the subject of the opportunity cost of other vehicle attributes⁵⁷⁹ and Greene (2018), who found extensive variation in willingness-to-pay estimates across the literature.

NHTSA agrees with IPI that the theoretical discussion of constrained consumer choice under binding fuel economy standards has not been tested empirically, and for this reason has not incorporated an estimate of the opportunity cost of sacrifices in other vehicle attributes in its FRIA. NHTSA notes that the alternative explanations posited by IPI to explain the fuel efficiency gap also lack an empirical basis—instead, both the agency's and IPI's explanations are consistent with consumers' apparent willingness to forgo *some* fuel savings in favor of improvements to vehicles' other features. However, NHTSA notes that, because—as acknowledged later in its comment—IPI's comment overlooks the theoretical possibility that automakers could at some point run out of technologies that could improve performance such that the use of a technology to improve fuel economy rather than performance would necessarily mean a lack of availability of performance enhancements. Even if all available technologies were deployed to improve fuel economy rather than performance, and those technologies fully paid for themselves with discounted future fuel savings, then manufacturers would have no remaining technologies available to meet buyers' demands for improved performance. However, no such absolute technological constraint has been observed. Furthermore, the agency notes

⁵⁷⁸ Klier, Thomas, and Joshua Linn. 2016. "The Effect of Vehicle Fuel Economy Standards on Technology Adoption." *Journal of Public Economics* 133, pp. 41–63.

⁵⁷⁹ EPA Sci. Advisory Bd., Consideration of the Scientific and Technical Basis for the EPA's Proposed Rule Titled *The Safer Affordable Fuel-Efficient (SAFE) Vehicles Rule for Model Years 2021–2026 Passenger Cars and Light Trucks*, at 2 (Feb. 27, 2020), available at https://sab.epa.gov/ords/sab/f?p=100:18:6529621058907::RP,18:P18_ID:2550 ("We concur with the agencies that it is not yet feasible to quantify the impact on new vehicle sales of additional vehicle characteristics (beyond fuel economy) that are desired by consumers but restrained by federal standards."). David Greene et al., *Consumer Willingness to Pay for Vehicle Attributes: What Do We Know?*, 118 *TRANSP. RES. PART A: POL'Y & PRAC.* 258, 264, 273 (2018); see also *id.* at 274 (finding that, even after trimming outliers, "one standard deviation exceeds the mean of the [willingness to pay] estimates for most of the attributes" and that "the interquartile range also exceeds the median").

that IPI's comment lacks any consideration of how much households can afford to spend on vehicle loan payments, instead assuming that households will assume as much debt as necessary to purchase a vehicle with their preferred bundle of attributes. NADA commented that most households *already* cannot afford to purchase new vehicles, and noted that financing does not take into consideration potential fuel savings but instead relies on a borrower's income, finance amount, and credit worthiness.⁵⁸⁰

NHTSA acknowledges that the opportunity cost of regulations on other vehicle attributes is still an under-researched topic and relies heavily on economic theory, and for this reason, we are excluding estimates of this particular theoretical opportunity cost in its primary analysis. NADA provided some literature that it believes may assist the agency in developing an estimate of the opportunity cost of other vehicle attributes in the future, but NHTSA agrees with the EPA's Scientific Advisory board that there is little consensus on this issue. For illustrative purposes, NHTSA has included a sensitivity analysis estimating the theoretical opportunity cost of other vehicle attributes in the FRIA, although as discussed elsewhere, NHTSA is not confident that the assumptions used to generate this estimate are sound. NHTSA notes that the sensitivity analysis of opportunity costs is a rough, speculative proxy with multiple limitations that does not reflect many other effects that may largely offset such opportunity costs. The sensitivity estimate should be considered as an overestimate of the potential effects, and is not sufficiently robust to include in the main analysis. Opportunity cost from other vehicle attributes, to the extent it exists, may be small. NHTSA notes that consideration of such sensitivity analysis does not change NHTSA's conclusion that Alternative 2.5 is the maximum feasible and most appropriate standard under its statutory factors.

NADA also comments that the agency's assumption that potential buyers consider their expected future fuel savings over some assumed "payback period" when deciding whether to purchase models offering higher fuel economy oversimplified buyer's choices, even if other attributes

⁵⁸⁰ NADA, at 6–7. We note that EPA disagrees and has found that some lenders give discounts for loans to purchase more fuel-efficient vehicles. See EPA, Revised 2023 and Later Model Year Light-Duty Vehicle GHG Emissions Standards: Regulatory Impact Analysis at 8–27 and n.87 (2021).

⁵⁷⁵ *Id.*

⁵⁷⁶ *Id.* at 15.

⁵⁷⁷ Leard, B., J. Linn, and Y. Zhou. 2021. "How Much Do Consumers Value Fuel Economy and Performance? Evidence from Technology Adoption." *The Review of Economics and Statistics*: 1–45 (forthcoming). Adoption, *The Review of Economics and Statistics* 2021 (Leard, et al.).

of models they are comparing are closely comparable.⁵⁸¹ Specifically, NADA argues that both the importance of vehicle shoppers attach to higher fuel economy and the time horizon over which they evaluate savings in fuel costs from buying higher-MPG models vary in response to the direction and speed of recent movements in fuel prices, and that potential buyers appear to make the calculations the agency assumes only when fuel prices are increasing rapidly. When fuel prices are more stable, NADA argues that consumers appear to focus on vehicles' other attributes, and at current fuel prices NADA asserts that buyers are unlikely to demand more fuel-efficient cars and light trucks, particularly as their preferences continue to evolve toward SUV and CUV models.

On these points, NADA does not offer specific recommendations about how the agency could represent its interpretation of buyers' choice process, and the agency's interpretation is that doing so would require it to vary the assumed duration of buyers' payback period in response to both the direction and pace of recent changes in fuel prices, lengthening it when fuel prices are rising rapidly and shortening it when prices are stable or declining. While the agency does not believe that this approach is reasonable or practical, it has included sensitivity cases in the accompanying FRIA that consider both shorter and longer payback periods than the 2.5 years assumed in the central analysis, and believes their results should shed useful light on the potential effects of NADA's recommended approach.

For several reasons, we decided to retain our 30-month payback assumption for evaluating the alternatives we considered for the final rule. First, there was no consensus among commenters about a more appropriate payback period; approximately equal numbers of commenters urged the agency to lengthen, maintain, and shorten the duration of its assumed payback period. Second, none of the commenters who urged the agency to change the duration of its assumed payback period provided any additional evidence to support doing so, and thus NHTSA continues to believe that the information on which the payback decision is based is reasonable and appropriate. Finally, none provided plausible explanations for why adopting fuel economy standards should change vehicle buyers' time perspectives on future fuel savings, why their longer-term perspectives

would revert to their original shorter terms once those standards took effect, or why repeat buyers' values would once again adopt a longer-term perspective when valuing future fuel savings when standards were once again raised.

While we will continue to explore whether payback periods should differ between the baseline and regulatory alternatives that would establish higher standards, the agency still lacks a clear basis for identifying whether, how much, or how quickly future changes in CAFE standards could alter consumer perceptions of fuel economy and its value. In addition, neither the agency nor commenters has identified a satisfactory explanation for why once having adapted to the presence of higher fuel economy standards by lengthening the time horizon over which they value fuel savings, consumers would revert to their former lower values once those new standards became the reference point for evaluating further increases in required fuel economy. The agency will also re-examine whether a 30-month payback period is appropriate to use in analyzing future increases in standards, and will consider whether an expert elicitation is appropriate.

2. Fleet Composition

The composition of the on-road fleet—and how it changes in response to CAFE standards—determines many of the costs and benefits of the final standards. For example, how much fuel the light-duty fleet consumes is dependent on the number of new vehicles sold, how many older (and less efficient) vehicles are retired, and how many vehicles are driven.

Until recently, all previous CAFE rulemaking analyses used static fleet forecasts that were based on a combination of manufacturer compliance data, public data sources, and proprietary forecasts (or product plans submitted by manufacturers). When simulating compliance with regulatory alternatives, those analyses projected identical sales and retirements across the alternatives, for each manufacturer down to the make/model level—where the exact same number of each model variant was assumed to be sold in a given model year under both the least stringent alternative (typically the baseline) and the most stringent alternative considered (intended to represent “maximum technology” scenarios in some cases). To the extent that an alternative matched the assumptions made in the production of the proprietary forecast, using a static fleet based upon those assumptions may have been warranted.

However, a fleet forecast is unlikely to be representative of a broad set of regulatory alternatives with significant variation in the cost of new vehicles. Several commenters on previous regulatory actions and peer reviewers of the CAFE Model encouraged consideration of the potential impact of fuel efficiency standards on new vehicle prices and sales, the changes to compliance strategies that those shifts could necessitate, and the downstream impact on vehicle retirement rates. In particular, the continued growth of the utility vehicle segment causes changes within some manufacturers' fleets as sales volumes shift from one region of the footprint curve to another, or as mass is added to increase the ride height of a vehicle on a sedan platform to create a crossover utility vehicle, which exists on the same place of the footprint curve as the sedan upon which it might be based.

The analysis now dynamically simulates changes in the vehicle fleet's size, composition, and usage as manufacturers and consumers respond to regulatory alternatives, fuel prices, and macroeconomic conditions. The analysis of fleet composition comprises two forces, how new vehicle sales—the flow of new vehicles into the registered population—change in response to regulatory alternatives, and the influence of economic and regulatory factors on vehicle retirement (otherwise known as scrappage).

While commenters raised specific objections to several of the assumptions within the sales and scrappage modules—which are described below—commenters generally were supportive of the agency's approach to modeling fleet turnover. We did receive one comment from IPI suggesting that we should consider returning to a static fleet model if we were unable to correct what they perceived as modeling flaws. We disagree with IPI's assessment, because it is widely acknowledged that CAFE standards and other regulations on new vehicles can influence consumers' decisions about both purchasing new vehicles and retiring used ones, so to assume that the composition of the vehicle fleet is unaffected by regulations would ignore these well documented impacts. The agency feels that it is important to provide policymakers with the most comprehensive and complete analysis of the regulations, which includes understanding how CAFE standards will affect fleet turnover.

Below are brief descriptions that of how the agency models sales and scrappage. For a full explanation, refer to TSD Chapter 4.2.

⁵⁸¹ NADA, at 9.

(a) Sales

For the purposes of regulatory evaluation, the relevant sales metric is the difference in sales between alternatives rather than the absolute number of sales in any of the alternatives. As such, the sales response model currently contains three parts: A nominal forecast that provides the level of sales in the baseline (based upon macroeconomic inputs, exclusively), a price elasticity that creates sales differences relative to that baseline in each year, and a fleet share model that produces differences in the passenger car and light truck market share in each alternative. The nominal forecast does not include price and is merely a (continuous) function of several macroeconomic variables that are provided to the model as inputs. The price elasticity is also specified as an input. In the proposal, the agency assumed a price elasticity of sales of -1.0 and sought comment on this assumption.

Many commenters argued that NHTSA's unit elastic response assumption of -1.0 is inaccurate. The California Attorney General et al., IPI, ICCT, UCS, CBD et al., CARB and Dr. Kenneth Gillingham, all commented that -1.0 is too large and unsupported by the evidence.⁵⁸² CBD et al. and the California Attorney General noted that recent literature suggests a much lower figure, with California's Attorney General suggesting using the estimate from *Leard* (2021) of -0.34 and the CBD et al. suggesting between -0.2 or -0.4 (or lower). IPI suggested reducing the figure to at least -0.4 , the figure used by EPA in a recent sensitivity analysis. ICCT suggested that NHTSA use -0.5 , and further recommended that NHTSA consider using different elasticity estimates for different vehicle classes.

IPI and CBD et al. supported their suggested estimates by arguing that NHTSA should utilize a long-run elasticity estimate, not a short-run elasticity estimate.⁵⁸³ IPI explained that long-run price elasticity of demand for vehicles tends to be much lower than short run elasticity, because, due to the limited substitution options for personal vehicles, consumers will delay purchases when prices increase but are likely to still purchase a vehicle down the road. CBD et al. noted that that a

long-run estimate is more appropriate because consumers replace vehicles in the long run as they age and because it more closely matches the timeline of this agency action in which fuel economy standards apply years into the future. They also argued that a "more reasonable" price elasticity estimate would likely lead to greater projected increases in employment than already estimated in the proposed rule.

Dr. Mark Jacobsen commented that the demand elasticity that the agency used in the proposal is the improper measurement. Dr. Jacobsen argued that NHTSA should instead employ a "policy elasticity" since CAFE regulations will influence not only new vehicles prices but also used vehicle prices, since the two are substitutes.⁵⁸⁴ Because used vehicle prices are anticipated to increase, the change in sales in response to increasing CAFE standards will be less than what would be anticipated if only new vehicle prices were affected. Dr. Jacobsen suggested the policy elasticity ranges from -0.5 in the short-run to -0.28 in the long-run.

In contrast, NADA expressed support for a sales elasticity of -1.0 .⁵⁸⁵

While evaluating the concerns raised by commenters, NHTSA identified an error in the CARs report that the agency relied upon as a key source for selecting -1.0 . The CARs report erroneously reported the own-price elasticity of cars (-0.79) and trucks (-0.85) instead of the long-run elasticity of all light-duty vehicles (-0.39) for *Fischer* (2007). When considering the actual long-run elasticity in *Fischer* (2007), the totality of the evidence presented in the CARs report no longer supports an elasticity of -1.0 . In addition, after the publication of NHTSA's proposed rule, EPA issued a new report exploring the effects of changes in vehicle prices that arise from due to fuel efficiency regulations on vehicle sales. Since that report was authored by Dr. Jacobsen, it unsurprisingly echoed his comments summarized above, and recommended that the agency reduce the magnitude of the sales price elasticity it uses in its analysis to the range suggested above.⁵⁸⁶

For these reasons, NHTSA has elected to use a price elasticity of sales equal to -0.4 —meaning that a ten percent increase in the average price of a new

vehicle produces a four percent decrease in total sales—for the final rule. The price change to which this elasticity is applied is calculated as the per-vehicle average of manufacturers' estimated costs to meet higher CAFE standards, net of the fraction of vehicles expected lifetime fuel savings that new vehicle buyers are assumed to value (2.5 years or 25–30 percent of lifetime savings, as discussed in Section III.E.1. above). NADA commented that it believed the agency's sales model was not appropriately applying the sales elasticity to the assumed price increase and thus underestimated the likely decline in sales.⁵⁸⁷ However, the agency notes that NADA's rough sales estimates excluded any value of future fuel savings, and that this omission was likely to have caused the divergence between NADA's and NHTSA's estimates of changes in sales.

The current baseline sales module reflects the idea that total new vehicle sales are primarily driven by conditions in the economy that are exogenous to the automobile industry. Over time, new vehicle sales have followed macroeconomic cycles closely, rising when prevailing economic conditions are positive (periods of growth) and falling during periods of economic contraction. While the kinds of changes to vehicle offerings that occur because of manufacturers' compliance actions exert some influence on the total volume of new vehicle sales, their effects on new vehicle sales are secondary to those of overall economic conditions. Instead, they drive the kinds of marginal differences between regulatory alternatives that the current sales module is designed to simulate—making vehicles more expensive generally reduces total sales, although only modestly.

The first component of the sales response model is a nominal forecast, which is a statistical model (using a small set of inputs) that projects the size of the new vehicle market in each calendar year in the analysis period under the baseline (No-Action Alternative). Past reviewers expressed concerns about the possibility of econometrically estimating an industry average price elasticity in a way that isolates the causal effect of new vehicle prices on new vehicle sales (and properly addresses the issue of endogeneity between sales and price). However, the agency's current nominal forecast model does not include prices and is not intended for statistical inference around the question of price response in the new vehicle market;

⁵⁸² California Attorney General et al., Docket No. NHTSA–2021–0053–1499, Appendix A, at 32; IPI, A1, at 26–28; ICCT, Docket No. NHTSA–2021–0053–1581, at 3, 14, 19; UCS Docket No. NHTSA–2021–0053–1567, at 29; CBD et al., Joint Summary Comments, at 3–4, 6; CARB, Docket No. NHTSA–2021–0053–1542, Attachment 2, at 3.

⁵⁸³ IPI, at 26; CBD et al., Joint Summary Comments, at 6.

⁵⁸⁴ Dr. Mark Jacobsen, Docket No. NHTSA–2021–0053–1586, at 2.

⁵⁸⁵ NADA, at 11.

⁵⁸⁶ Chapter 4.3.2 of the FRIA accompanying this final rule includes a detailed discussion of the interactions between new and used vehicle markets identified in Dr. Jacobsen's report to EPA and their implications for the sensitivity of new vehicle sales and retirement of used vehicles to higher sales prices.

⁵⁸⁷ NADA, at 12.

instead, it is intended to simulate the general trajectory of the market for light duty vehicles. As discussed in more detail in Section III below, the current economic climate and the economy's performance during the continuing pandemic has created unusually extreme uncertainty about this year-to-year forecast. Particularly in the near-term, there is significant uncertainty about the pace at which the market for automobiles will recover—and the scale and timing of the recovery's peak—before the market returns to its long-term trend.

The second component of the sales response model captures how price changes affect the number of vehicles sold, by applying an assumed price elasticity to the percentage change in average price (in each future year) to determine the percent change in sales from its projected baseline value. This price change does not represent an increase/decrease over the last observed year, but rather the percentage difference under each regulatory alternative relative to the estimated baseline price during that year. In the baseline, the average price is defined as the observed new vehicle price in 2019 (the last historical year before the simulation begins) plus the average regulatory cost associated with the No-Action Alternative.⁵⁸⁸ The central analysis in this final rule simulates multiple programs simultaneously (CAFE final standards, EPA final greenhouse gas standards, ZEV, and the California Framework Agreements), and the regulatory cost includes both technology costs and civil penalties paid for non-compliance (with CAFE standards) in a model year. Because the elasticity assumes no perceived change in the quality of the product, and the vehicles produced under different regulatory scenarios have inherently different operating costs, the price metric must account for this difference. The price to which the elasticity is applied in this analysis represents the residual price change *between scenarios* after accounting for 2.5 years' worth of fuel savings to the new vehicle buyer.

The third and final component of the sales model is the dynamic fleet share module (DFS). Some commenters to previous rules noted that the market share of SUVs continues to grow, while

conventional passenger car body-styles continue to lose market share. For instance, in the 2012 final rule, the agencies projected fleet shares based on the continuation of the baseline standards (MYs 2012–2016) and a fuel price forecast that was much higher than the realized prices since that time. As a result, that analysis assumed passenger car body-styles would comprise about 70 percent of the new vehicle market by 2025, which was internally consistent. The reality, however, has been quite different: In MY 2020, light truck models accounted for 57 percent of new light-duty vehicle sales.⁵⁸⁹ The CAFE Model includes the DFS model in an attempt to address these market realities. The DFS distributes the total industry sales across two different body-types: “cars” and “light trucks.” While there are specific definitions of “passenger cars” and “light trucks” that determine a vehicle's regulatory class, the distinction used in this phase of the analysis is more simplistic. All body-styles that are obviously cars—sedans, coupes, convertibles, hatchbacks, and station wagons—are defined as “cars” for the purpose of determining fleet share. Everything else—SUVs, smaller SUVs (crossovers), vans, and pickup trucks—are defined as “light trucks”—even though they may not be treated as such for compliance purposes. The DFS uses two functions from the National Energy Modeling System (NEMS) used in the 2017 AEO to independently estimate the share of passenger cars and light trucks, respectively, given average new market attributes (fuel economy, horsepower, and curb weight) for each group and current fuel prices, as well as the prior year's market share and prior year's attributes. The two independently estimated shares are then normalized to ensure that they sum to one. These shares are applied to the total industry sales derived in the first stage of the sales response. This produces total industry volumes of car and light truck body styles. Individual model sales are then determined from there based on the following sequence: (1) Individual manufacturer shares of each body style (either car or light truck) times the total industry sales of that body style, then (2) each vehicle within a manufacturer's volume of that body-style is given the same percentage of sales as appear in the 2020 fleet. This implicitly assumes that consumer preferences for particular

styles of vehicles are determined in the aggregate (at the industry level), but that manufacturers' sales shares of those body styles are consistent with MY 2020 sales. Within a given body style, a manufacturer's sales shares of individual models are also assumed to be constant over time. This approach implicitly assumes that manufacturers are currently pricing individual vehicle models within market segments in a way that maximizes their profit. Without more information about each OEM's true cost of production and operation, fixed and variables costs, and both desired and achievable profit margins on individual vehicle models, there is no basis to assume that strategic shifts within a manufacturer's portfolio will occur in response to standards.

The DFS model shows passenger car styles gaining share with higher fuel prices and losing them when prices are decline. Similarly, as fuel economy increases in light truck models, which offer consumers other desirable attributes beyond fuel economy (ride height or interior volume, for example) their relative share increases. However, this approach does not suggest that consumers dislike fuel economy in passenger cars, but merely recognizes the fact that fuel economy has diminishing returns in terms of fuel savings. As the fuel economy of light trucks increases, the tradeoff between passenger car and light truck purchases increasingly involves a consideration of other attributes. The coefficients also show a relatively stronger preference for power improvements in cars than light trucks because that is an attribute where trucks have typically outperformed cars, just as cars have outperformed trucks for fuel economy.

NHTSA received a several comments about the dynamic fleet share model. ICCT commented that the coefficient for horsepower for passenger cars was negative, implying that passenger cars with lower fuel economy and less power are more attractive to consumers.⁵⁹⁰ Both ICCT and IPI also noted the counterintuitive sign for fuel economy, and suggested that the model was inadequate because it estimates the share of cars and trucks independently and fails to consider other vehicle attributes such as sales prices.⁵⁹¹ Neither IPI nor ICCT suggested revisions to the current DFS model structure that would address these concerns. Alternative approaches such as the simplified discrete choice model of market share suggested by ICCT or

⁵⁸⁸ The CAFE Model currently operates as if all costs incurred by the manufacturer as a consequence of meeting regulatory requirements, whether those are the cost of additional technology applied to vehicles in order to improve fleetwide fuel economy or civil penalties paid when fleets fail to achieve their standard, are “passed through” to buyers of new vehicles in the form of price increases.

⁵⁸⁹ Calculated from summary data tables accompanying EPA Automotive Trends Report, 2021 edition, <https://www.epa.gov/automotive-trends/explore-automotive-trends-data#SummaryData>. (Accessed: March 15, 2022).

⁵⁹⁰ ICCT, Appendix: Additional Comments, at 14.

⁵⁹¹ ICCT, Appendix: Additional Comments, at 14, 20; IPI, at 29.

assuming that fleet shares remain constant could be readily implemented, although both have potentially important drawbacks.

The agency agrees with ICCT that a discrete choice model calibrated to aggregate market share data may avoid some of the challenges of discrete choice modeling using data on individual buyers' choices but notes that other impediments to using it would undoubtedly still arise—for example, accounting for future changes in the classification of some individual vehicle models, or for shifts in buyers' preferences toward car or truck-based designs. The agency also believes that assuming fixed fleet shares is clearly an unsatisfactory approach in light of both gradual longer-term changes in buyers' apparent preferences and the very rapid recent shifts in market shares for cars and light trucks.

NHTSA agrees that a dynamic fleet share model that includes the attributes identified by commenters, such as IPI, would be preferable. In fact, the agency developed a number of simplified market share models for potential use in this analysis, each of which estimated the shares of cars and light trucks jointly using different combinations of attributes buyers are likely to consider when choosing among competing models. We also attempted to incorporate vehicle prices and develop specifications that would produce logically consistent coefficients for each variable they included. The agency was unable to produce a model that met all three criteria—including vehicle prices proved particularly troublesome—and these alternative models each suffered from their own limitations.⁵⁹² For two main reasons, the agency ultimately decided to retain the DFS used in the proposal instead of employing one of the newer models it developed: First, the alternative models did not clearly meet the criteria we established to be considered a better model. Second, the agency feels that the DFS used in the proposal produced logically consistent results *among* the alternatives it considered in this analysis. As noted elsewhere in this rule, isolating the impact of alternatives is more an art of internal precision within the model than an exercise in “external validity” or accuracy. The agency will continue to explore alternative DFS models for future rulemakings.⁵⁹³

⁵⁹² See “Exploration of alternate fleet share module” in Docket No. NHTSA–2021–0053.

⁵⁹³ As with all aspects of this analysis, uncertainty abounds. If NHTSA's current approach to modeling fleet share inaccurately overestimates the future fleet's proportion of light trucks, then NHTSA may have underestimated fuel savings and

Over the course of past rulemakings, many commenters have encouraged the agency to consider vehicle attributes beyond price and fuel economy when estimating a sales response to fuel economy standards. Some have suggested that a more detailed representation of the new vehicle market would enable the agency to incorporate the effect of additional vehicle attributes on buyers' choices among competing models, reflect consumers' differing preferences for specific vehicle attributes, and provide the capability to simulate responses such as strategic pricing strategies by manufacturers intended to alter the mix of models they sell and enable them to comply with new CAFE standards. For these purposes, nearly all of those commenters have suggested that the agency develop a disaggregate model of buyers' vehicle choices.⁵⁹⁴

A correctly specified choice model with parameters estimated from characteristics of individual shoppers (or households) and their choices among vehicle models—including decisions by some not to purchase new vehicles—offers the potential to produce consistent forecasts of total sales of new vehicles and the shares represented by cars and light trucks (as well as specific body styles and potentially even individual models). Developing such a model would also provide estimates of the value buyers attach to improved fuel economy and other vehicle attributes that were consistent with and reflected in its forecasts of total sales and market shares for individual vehicle types. For these reasons, the agency has invested considerable resources in developing such a discrete choice model of the new automobile market, although those investments have not yet produced a satisfactory and operational model.

The agency's experience partly reflects the fact that discrete choice models are highly sensitive to their data inputs and estimation procedures, and even versions that fit well when calibrated to data from a single period—usually a cross-section of vehicles and shoppers or actual buyers—often produce unreliable forecasts for future periods, which the agency's regulatory analyses invariably require. This occurs because they are often unresponsive to relevant shifts in economic conditions or consumer preferences, and also

overestimated emissions of the regulatory alternatives included in this analysis.

⁵⁹⁴ Comments to this effect on the proposed rule were infrequent, and the only example generally cited much more detailed applications or advantages of discrete choice models; see Auto Innovators, Docket No. NHTSA–2021–0053–1492, at 56.

because it is difficult to incorporate factors such as the introduction of new model offerings—particularly those utilizing advances in technology or vehicle design—or shifts in manufacturers' pricing strategies into their representations of choices and forecasts of future sales or market shares. For these reasons, most vehicle choice models have been better suited for analysis of the determinants of historical variation in sales patterns than to forecasting future sales volumes and market shares of particular categories.

Although these challenges have so far precluded the agency from employing a discrete choice model in its regulatory analyses, we believe they are not insurmountable and recognize the considerable advantages such a model could offer.⁵⁹⁵ Thus, the agency intends to continue its attempts to develop some suitable variant of such a model for use in future fuel economy rulemakings.

(b) Scrappage

New and used vehicles are substitutes. When the price of a good's substitute increases (decreases), the demand curve for that good shifts upwards (downwards) and the equilibrium price and quantity supplied also increases (decreases). Thus, increasing the quality-adjusted price of new vehicles will result in an increase in equilibrium price and quantity of used vehicles. Since, by definition, used vehicles are not being “produced” but rather “supplied” from the existing fleet, the increase in quantity must come via a reduction in their scrappage rates. Practically, when new vehicles become more expensive, demand for used vehicles increases (and they become more expensive). Because used vehicles are more valuable in such circumstances, they are scrapped at a lower rate, and just as rising new vehicle prices push marginal prospective buyers into the used vehicle market, rising used vehicle prices force marginal prospective buyers of used vehicles to acquire older vehicles or vehicles with fewer desired attributes. The effect of fuel economy standards on scrappage is partially dependent on how consumers value future fuel savings and our assumption that consumers value only the first 30 months of fuel savings.

Many competing factors influence the decision to scrap a vehicle, including the cost to maintain and operate it, the household's demand for VMT, the cost of alternative means of transportation,

⁵⁹⁵ For an additional overview of the challenges of employing a discrete choice model, see TSD Section 4.2.1.

and the value that can be attained through reselling or scrapping the vehicle for parts. A car owner will decide to scrap a vehicle when the value of the vehicle is less than the value of the vehicle as scrap metal, plus the cost to maintain or repair the vehicle. In other words, the owner gets more value from scrapping the vehicle than continuing to drive it, or from selling it. Typically, the owner that scraps the vehicle is not the first owner.

While scrappage decisions are made at the household level, the agency is unaware of sufficient household data to capture scrappage at that level. Instead, the agency uses aggregate data measures that capture broader market trends. Additionally, the aggregate results are consistent with the rest of the CAFE Model as the model does not attempt to model how manufacturers will price new vehicles; the model instead assumes that all regulatory costs to make a particular vehicle compliant are passed onto the purchaser who buys the vehicle. It is more likely that manufacturers will defray a portion of the increased regulatory cost across its vehicles or to other manufacturers' buyers through the sale of credits.

The most predictive element of vehicle scrappage is "engineering scrappage." This source of scrappage is largely determined by the age of a vehicle and the durability of a specific model year vintage. The agency uses proprietary vehicle registration data from IHS/Polk to compute vehicle age and durability for each model year or vintage. Other factors affecting scrappage include fuel economy and new vehicle prices. For historical data on new vehicle transaction prices, the agency uses National Automobile Dealers Association (NADA) data.⁵⁹⁶ These data consist of the average transaction price of all light-duty vehicles; since the transaction prices are not broken-down by body style, the model may miss unique trends within a particular vehicle body style. The transaction prices are the amount consumers paid for new vehicles and exclude any trade-in value credited towards the purchase. This may be particularly relevant for pickup trucks, which have experienced considerable changes in average price as luxury and high-end options entered the market over the past decade. Future models will further consider incorporating price series that represent the price trends for cars, SUVs and vans, and pickups separately. Vehicle scrappage is also

influenced by cyclical market trends, which the model captures using forecasts of GDP and fuel prices.

Vehicle scrappage follows a roughly "S-shaped" pattern with increasing age—that is, when a model year (or "vintage") is relatively new few vehicles of its age are scrapped; progressively more are retired as they age and accumulate use, but after some age retirements again slow. Although fewer and fewer of the vehicles originally produced during a model year remain on the road as they age, the annual *rate* at which they are retired typically reaches a peak sometime around age 20 and declines gradually after that.⁵⁹⁷ The agency's model employs a logistic function to capture this relationship of vehicle scrappage rates to age.

Historical registration data show that vehicles produced during more recent model years generally last longer than those from earlier vintages, indicating that the durability of successive model years has improved over time, although there are occasional exceptions to this broader pattern. Annual scrappage rates for vehicles produced during more recent model years are also observed to be lower than those of earlier vintages up to a certain age, but are necessarily higher after that age to account for the fact that the share of original vehicles remaining in use ultimately converges toward the minimal share (zero, in the extreme) observed for earlier vintages.⁵⁹⁸

The agency includes indicator variables for each model year in its scrappage model to capture these historical improvements in vehicles' durability over successive model years. Additionally, to ensure that vehicles approaching the end of their assumed 40-year service life are retired, the agency applies a decay function to the number remaining in use after they reach age 30. Retirement rates for individual model years are modeled primarily as a polynomial function of age to capture the non-linear shape described above. The effective change in new vehicle prices projected in the model (defined as technology costs minus 30 months of fuel savings, as

discussed previously) is also included in the model, which produces differing scrappage rates across regulatory alternatives since each one includes different estimates of technology costs and fuel savings. Finally, the model also includes year-to-year differences in U.S. GDP (to capture the effects of macroeconomic cycles on owners' decisions to keep older vehicles in use), fuel prices, and fuel costs for used vehicles of each age, as well as the share of vehicles originally produced during each model year remaining in use.

In addition to the variables included in the scrappage model, the agency considered several other variables that may influence scrappage in the real world including, maintenance and repair costs, the value of scrapped metal, vehicle characteristics, the quantity of new vehicles purchased, higher interest rates, and unemployment. These variables were excluded from the model either because of a lack of underlying data or modeling constraints. Their exclusion from the model is not intended to reflect their unimportance, but rather highlights the practical constraints of modeling intricate decisions like scrappage.

The agency received some comments on modeling approaches that could explicitly represent interactions between the new and used vehicle markets, such as the influence of prices for new models on demand for used vehicles (and the reverse), and the relationship between scrappage rates and consumers' decisions about replacing retired vehicles (*e.g.*, Jacobsen as discussed in Section III.E.2.a) and FRIA Chapter 4.3.2). On scrappage rates specifically, the American Fuel & Petrochemical Manufacturers (AFPM) cautioned the agency against overestimating scrappage rates, highlighting the effect of current macroeconomic conditions on new and used car prices and thus on owners' decision to retire used vehicles.⁵⁹⁹ While we agree with the assertion of AFPM that scrappage rates are important in accurately representing fleet turnover and the resulting composition of the light duty vehicle fleet, the agency found it difficult to quantitatively isolate the effect of economic conditions on short-term scrappage decisions from longer term trends in vehicle durability and other factors affecting retirement rates when developing its scrappage model. For this reason, NHTSA has elected to maintain the existing treatment of scrappage for this rule, but will continue to monitor

⁵⁹⁷ The retirement *rate* is usually measured by the number of vehicles originally produced during a model year that are retired during a subsequent (calendar) year, expressed as a fraction of the number that remained in use at its outset.

⁵⁹⁸ Examples of why durability may have changed are new automakers entering the market or general changes to manufacturing practices like switching some models from a car chassis to a truck chassis. The agency caps model years' lifetimes at 40 years in its accounting; by that age a slightly larger share of each successive model year tends to remain in use, although this share so far remains below 2 percent of those originally produced.

⁵⁹⁶ The data can be obtained from NADA. For reference, the data for MY 2020 may be found at <https://www.nada.org/nadadata/>.

⁵⁹⁹ AFPM, Docket No. NHTSA–2021–0053–1530, at 18.

research related to both short- and long-term scrappage patterns in the vehicle fleet.

Changes in Vehicle Miles Traveled (VMT)

The anticipated level of future vehicle use, usually measured by the number of vehicle-miles driven annually (VMT), directly influences most of the effects of raising fuel economy standards that decision-makers consider in determining what standards to establish. Most important, the amount and value of fuel saved by requiring new cars and light trucks to achieve higher fuel economy both depend on the number of miles they are driven each year over their lifetimes, as well as of course on how much raising CAFE standards improves their fuel economy and on future fuel prices. Similarly, critical indirect impacts from raising fuel economy standards such as changes in emissions of criteria air pollutants and greenhouse gases, potential increases in fatalities and injuries, and congestion levels also depend directly on the consequences of higher standards for vehicle use.

NHTSA's CAFE Model estimates total yearly VMT as the product of average annual usage per vehicle and the number of vehicles making up each future year's fleet, which itself depends on new vehicle sales during the current and previous years and owners' decisions about when to retire used vehicles. Since cars and light trucks of different model years (or "vintages") and body styles will experience different cost increases and varying increases in their fuel economy when CAFE standards are raised—particularly when standards increase over a succession of model years—the costs necessary to achieve their required fuel economy levels as well as the resulting fuel savings and indirect benefits will differ. Vehicles originally produced during a model year are gradually retired and the usage of those remaining in service tends to decline as they age (at least on average), so fuel savings and other benefits from requiring them to achieve higher fuel economy also decline gradually over their lifetimes. In any future calendar year, the contributions of progressively older model years to total benefits will also decline gradually, since fewer will remain in use and those that do will be driven less, although this pattern will also be affected by the increases in fuel economy required for earlier model years.⁶⁰⁰

⁶⁰⁰ A vehicle's age during a future calendar year is equal to that calendar year minus the model year

Thus, accounting properly for the effects of vehicle use on the costs and benefits from establishing higher CAFE standards requires estimates of VMT in each future calendar year accounted for by vehicles of different types and original model years (which determines their current age during that year). The agency estimates VMT by vehicles of different types and ages during future calendar years as the product of the number of vehicles of each type and age in service during that year and their average annual use. Because vehicles' annual use throughout their lifetimes is influenced by their fuel economy—through its effect on the cost of driving each mile—the VMT accounted for by vehicles of each body type and model year will vary among regulatory alternatives that require larger increases in fuel economy from its baseline level.

To develop estimates of average vehicle use by body type and model year for future calendar years, the agency used odometer readings collected at different dates for a very large sample of vehicles to estimate average annual use at each age for cars and light trucks of different body types (automobiles, SUVs/vans, and pickups). These initial "mileage accumulation schedules" summarize how much vehicles of each body type and age were driven during 2016, and provide a basis to estimate how much vehicles produced during future model years will be driven at each age throughout their lifetimes. As described in detail in TSD Chapter 4.3, these initial schedules are adjusted to incorporate the effects of both differences in fuel prices between 2016 and future calendar years, and differences in the fuel economy of vehicles of each age during 2016 and those that will be of that same during each future calendar year.

The agency's CAFE Model uses the estimates of future sales of new cars and light trucks and annual retirement rates for used vehicles of different ages constructed as described previously to project the number of vehicles of each type and age that will be in use during each future calendar year it analyzes. It combines these with the estimates of average vehicle use at each age for different vehicle types to calculate their total VMT and uses the shares operating on different fuels (gasoline, diesel, and electricity) and their on-road fuel

in which it was originally produced (and assumed to be sold); for example, model year 2020 cars and light trucks will be 10 or 11 years old during calendar year 2030, depending on whether they were considered to be 0 or 1 year old during 2020. (The agency's analysis uses the former convention, so as an illustration, model year 2010 vehicles are considered to be 11 years old during 2020.)

efficiency to estimate total consumption of each fuel. Finally, the model applies per-mile and per-gallon emission rates to estimate total emissions accounted for vehicles of each type and age during future calendar years. For more aggregate reporting of costs and benefits, the agency sums these estimates to obtain total vehicle use, fuel consumption, emissions, and other measures by vehicle type in each calendar year, as well as lifetime travel, fuel use, emissions, etc. for vehicles of each type and model year.

NHTSA's perspective is that total demand for car and light truck travel should not vary significantly among the regulatory alternatives it considers, since the basic travel demands of a typical household are unlikely to be influenced much by the differences in vehicle prices or driving costs likely to be associated with different CAFE standards. However, the method the CAFE Model uses to calculate total VMT described above (and in more detail in TSD Chapter 4.3), can create modest differences in total VMT across the range of regulatory alternatives, even without considering the potential effect of fuel economy differences among those alternatives on vehicle use. These arise from the effects of differences in new vehicle sales and retirement rates for used vehicles among alternatives on the composition of the vehicle fleet—its makeup by vehicle type and age or original model year—during future years. Although small, these differences in the representation of vehicle types and model years in the future fleet can have significant impacts on the incremental costs and benefits of different regulatory alternatives when those are measured against the baseline.

To prevent the estimated effects of our standards from having unrealistic implications for household vehicle ownership or travel demand, the agency sought in this analysis to ensure that the fuel consumption, emissions, safety, and other impacts it reports for different regulatory alternatives reflect only differences in total vehicle use that are specifically attributable to their differing fuel economy requirements, and do not incorporate differences in the number of cars and light trucks in use under each alternative. To do this the CAFE Model constrains the level of future vehicle use under each regulatory alternative *before applying the fuel economy rebound effect* to match values projected using the Federal Highway Administration's VMT forecasting model. In future years where this total "pre-rebound effect" VMT calculated internally by the CAFE Model differs from the FHWA forecast, each model year cohort's average VMT

is adjusted up or down so that the two estimates match. This process ensures that any differences in total VMT among regulatory alternatives is attributable to the fuel economy rebound effect. It also ensures that the forecasts of total VMT for future years constructed using the “bottom up” process of estimating VMT separately for each vehicle type and age and summing the results, as described immediately above, are consistent with forecasts of aggregate VMT that are based on an underlying theory of household travel demand and independent forecasts of its demographic and economic determinants.

The agency’s analysis of this final rule begins with the year 2020 and relies on actual data rather than forecasts for that year wherever possible. The elements of the analysis that rely most heavily on macroeconomic inputs—aggregate demand for VMT, new vehicle sales, and used vehicle retirement rates—all reflect the economy’s unexpectedly rapid return to pre-pandemic levels of activity and expected future growth, and these conditions prevail under each of the regulatory alternatives considered. The Federal Highway Administration (FHWA) publishes annual estimates of VMT for the light-duty vehicle fleet; while FHWA’s definition of light-duty vehicles differs slightly from those subject to CAFE standards, over the period from 2016 through 2019 FHWA’s estimates of VMT have agreed closely with those generated internally by NHTSA’s CAFE Model.⁶⁰¹ In 2020, however, the effects of the COVID pandemic—including sharply reduced demand for travel and mandated travel restrictions—reduced light-duty VMT significantly from its 2019 level, and this decline persisted through much of 2021.

Although this downturn in travel activity was accurately reflected in FHWA’s published estimates of light-duty vehicle travel for the year 2020 and

monthly travel volumes during 2021, it was not captured in the VMT estimates produced internally by NHTSA’s CAFE Model because those rely on vehicle use and registration estimates that could not readily be adjusted to account for sharply reduced commuting, shopping, and recreational travel or for restrictions on vehicle use that were imposed in some locations. To avoid the problems that relying on the models’ internally generated forecasts for 2020 and 2021 would have caused, the agency’s analysis for this final rule relied on FHWA’s published estimate of light-duty VMT for 2020 and extrapolated the volumes reported in that agency’s monthly travel updates through October of 2021 to develop an estimate of annual VMT for 2021.

The fuel economy rebound effect—a specific example of the well-documented energy efficiency rebound effect for energy-consuming capital goods—refers to the tendency of motor vehicles’ use to increase when their fuel economy is improved and the fuel cost to drive each mile declines as a result. A regulatory alternative that establishes more stringent CAFE standards than those assumed to prevail under the baseline scenario will increase the fuel economy of new cars and light trucks, thereby reducing their pre-mile fuel consumption and fuel costs and increasing the number of miles they are driven annually over their lifetimes. The assumed magnitude of this fuel economy rebound effect influences the overall costs and benefits associated with each regulatory alternative considered, as well as the estimates of its effects on fatalities and other safety measures. Thus, its value—together with fuel prices, technology costs, and other analytical inputs—is part of the body of information that agency decision-makers have considered in selecting the CAFE standards this final rule establishes. By magnifying the effect of higher fuel economy on vehicle use, larger values of the fuel economy rebound effect also reduce the economic and environmental benefits associated with increased fuel efficiency.

The agency received a number of comments on the value of the rebound effect. Most commenters argued that the agency rebound selection of 15 percent was too high and suggested that the literature supported a rebound magnitude ranging from 5 to 10 percent; most commenters supported using a rebound of 10 percent.⁶⁰³ A few

commenters argued that an even lower value such as 5 percent should be used instead.⁶⁰⁴ While Auto Innovators did not comment directly on the agency’s choice of 15 percent, it argued that the agency’s estimate of rebound did not take into consideration of “attribute substitution,” whereby a household will buy a less fuel efficient vehicle as their second vehicle and will make a decision on which vehicle to use depending on the purpose for any particular trip.⁶⁰⁵ The agency notes that Auto Innovators did not provide any guidance on the likely direction of this “attribute substitution” effect—which is not clear *a priori*—in its comment, nor provide any suggestions for how to account for it in the analysis.

ICCT commented in general support of the methodology used to construct the vehicle mileage accumulation schedules, but suggested that the agency could further improve them by considering how increased durability of successive models could cause newer vehicles to be driven more as they age than their older counterparts.⁶⁰⁶ The agency notes that ICCT is correct that increased durability can increase VMT. NHTSA captures this possibility in the scrappage model, where more recent model years tend to be retained in service longer, and also in its application of the fuel economy rebound effect, where vehicles featuring higher fuel economy are assumed to be used more intensively throughout their lifetimes. The agency notes that the data and methods it used to develop the mileage accumulation schedules capture the increasing durability of recent model year to some extent, because as described in detail in TSD Chapter 4.3 those data include a range of model years observed over several decades, and increased durability is not a recent phenomenon. Treating model years as a “panel” when estimating the pattern of vehicle use with age explicitly accounts for both increases in the fraction of vehicles produced during successive model years that remain in use at each age and any accompanying increase in the average use of vehicles of different ages.

Several of the commenters also seemed to suggest that we should not consider the impacts of rebound driving at all since they are freely chosen.⁶⁰⁷ We note that rebound driving is an expected

⁶⁰¹ See Highway Statistics 2017, Table VM-1, available at <https://www.fhwa.dot.gov/policyinformation/statistics/2017/vm1.cfm>.

(Accessed: March 15, 2022) FHWA’s estimates of VMT include travel by light-duty trucks up to 10,000 lbs. GVW, while the CAFE program excludes trucks with GVWs exceeding 8,500 lbs. FHWA reported light-duty VMT of 2.86 trillion for calendar year 2016, while NHTSA’s model generated an internal estimate of 2.85 trillion VMT by vehicles subject to CAFE standards. The two estimates did not compare as closely for subsequent years, but never differed by more than 2 percent.

⁶⁰² NHTSA’s estimates of total VMT rely on estimates of average annual mileage for light-duty vehicles at each age, calibrated to 2016 data, together with the number of registered light-duty vehicles at each age. Chapter 4 of the TSD accompanying this rulemaking describes these data and the process NHTSA uses to estimate total VMT in detail.

⁶⁰³ See California Attorney General et al., Docket No. NHTSA-2021-0053-1526-A1, at 2; UCS, Docket No. NHTSA-2021-0053-1567-A1, at 32; CBD et al., Joint Summary Comments, at 2-3; ICCT,

A1, at 14; Lucid, Docket No. NHTSA-2021-0053-1584-A1, at 6; IPI, at 35-37; and CARB, Docket No. NHTSA-2021-0053-1521-A2, at 2-3.

⁶⁰⁴ See e.g., CFA, Docket No. NHTSA-2021-0053-1535, at 4-5.

⁶⁰⁵ Auto Innovators, at 93-94.

⁶⁰⁶ ICCT, at 22-23.

⁶⁰⁷ See, e.g., CBD et al., at 17.

result of this final rule, and that understanding how increased fuel efficiency will affect additional mobility deserves consideration even if there is an offsetting mobility benefit. In addition, the question of whether and how to consider the rebound effect and its consequences is an aspect of the agency's determination of what standard represents the "maximum feasible," which is a separate question from the more technical issue of what the appropriate value for the rebound effect should be in the analysis.

As described in detail in TSD Chapter 4.3.5, the agency conducted a thorough and detailed review of recent research on the fuel economy rebound effect, which includes several new estimates it had not previously considered and also incorporates statistical uncertainty surrounding different estimates. The agency's updated review shows that research measuring the response of vehicle use to fuel economy itself suggests a rebound effect ranging from 5 to 15 percent, while studies examining the association of vehicle use to fuel costs of driving suggest that the rebound effect is most likely to lie in the range from 10 to 20 percent.

Based on this updated analysis, the agency selected a rebound effect of 10 percent for this analysis, because it was well-supported by the totality of the evidence and aligned closely with the response of total vehicle use to fuel costs incorporated in FHWA's forecasting model (approximately 14 percent). This value is also consistent with the value used in EPA's recent final rule. To recognizing the wide range of uncertainty surrounding the true value of the fuel economy rebound effect, we also examine the sensitivity of estimated impacts to values ranging from 5 to 20 percent.

To calculate levels of total light-duty that incorporate the fuel economy rebound effect, the CAFE Model interprets the assumed magnitude of the rebound effect as an elasticity of average vehicle use with respect to fuel cost per mile, and applies this to changes in fuel costs resulting from the higher fuel economy levels each regulatory alternative requires. It then adds the resulting proportional increases in average vehicle use to their values under the No-Action Alternative, as previously adjusted to reconcile the CAFE Model's estimate of total VMT with that produced by FHWA's travel forecasting model. TSD Chapter 4.3 provides an extensive discussion of how the agency calculates changes in VMT to account for the rebound effect.

Jacobsen and Liao commented on the agency's procedures for estimating VMT

and incorporating the rebound effect, noting that while still in progress, their recent research shows that by raising prices for new cars and light trucks, higher CAFE standards increase the depreciation cost their owners incur in driving each mile.⁶⁰⁸ They assert that the response of vehicle use to higher per-mile depreciations costs outweighs its response to the reduction in fuel costs from required increases in their fuel economy, although they do not report empirical results demonstrating this effect. These commenters also argue that the reduction in sales of new vehicles in response to higher new car and light truck prices will reinforce this effect, because households owning fewer vehicles will drive less in total as complementarity between the number of vehicles households own and their trip-making frequency operates in reverse. They argue that as these two effects interact with the usual fuel economy rebound effect, higher CAFE standards will reduce average vehicle use on balance rather than increasing it as the agency estimates.⁶⁰⁹

The agency agrees that higher per-mile depreciation costs are likely by themselves to reduce vehicle use but notes that only some fraction of vehicles' total depreciation costs owes to their usage, with the remainder attributable to the passage of time and technological progress in new vehicle designs and utility. Empirical estimates of this breakdown are scarce, so it is difficult to assess how large the increase in per-mile depreciation costs associated with a given increase in new vehicles' prices might be. We also note that increasing durability of new cars and light trucks over time tends to reduce the depreciation costs associated with their use, simply because their lifetime use-related depreciation is distributed over a larger number of miles. The agency notes further that the increases in new car and light truck prices it estimates will occur as consequences of the alternatives it considered for this analysis are quite modest, particularly after they are adjusted to reflect their buyers' assumed valuation of the higher fuel economy they provide. Combined with their increased durability and the fact that only a fraction of their higher prices is reflected in increased use-related depreciation, the implied increases in their per-mile depreciation costs are likely to be extremely small. Finally, we also note that empirical estimates of the fuel economy rebound effect generally

⁶⁰⁸ Jacobsen and Liao, NHTSA-2021-0053-0065, at 1.

⁶⁰⁹ Jacobsen and Liao, at 2.

do not control for potential increases in vehicles' purchase prices and accompanying depreciation costs. As a consequence, the association between higher fuel economy (or lower per-mile fuel costs) and higher per-mile depreciation is likely to be incorporated to some extent in estimates the rebound effect, in which case they can be interpreted as the combined or net effect of these countervailing changes on vehicle use.

4. Changes to Fuel Consumption

The agency combines modeled fuel economy levels with age and body-style VMT estimates to determine changes in fuel consumption over time and across alternatives. The agency computes the amount of fuel consumed by dividing expected total travel by predicted MPG at the vehicle level and then aggregates to produce estimates of total fuel consumed in each alternative.⁶¹⁰

F. Simulating Environmental Impacts of Regulatory Alternatives

In estimating the environmental impacts of each regulatory alternative we considered, the agency accounted for the projected application of many fuel-saving technologies to vehicles that could continue to use only gasoline or diesel fuel (including hybrid electric vehicles that do not require external charging), as well as the projected increased application of plug-in hybrid electric vehicles and, with some analytical constraints, battery electric vehicles.⁶¹¹ By reducing overall energy consumption and the production and use of petroleum-based fuels, the alternatives the agency considered would thus have important consequences for the environment and public health. These occur because each alternative would reduce tailpipe emissions of both GHGs and criteria air pollutants during vehicle operation, as well as "upstream" emissions that occur during petroleum extraction, transportation, and refining to produce fuel, as well as during the transportation, storage, and distribution of refined fuel. In turn, reduced emissions of GHGs and air pollutants would improve environmental quality, reduce the health consequences of

⁶¹⁰ Total value of fuel consumed is computed across all fuel types and draws fuel price values (e.g., retail prices for gasoline and electricity) from the set of model inputs.

⁶¹¹ This document and FRIA do not consider the potential for manufacturers to respond to new standards for MYs 2024-2026 by introducing new BEV models in MYs 2024-2026. However, the accompanying Supplemental Environmental Impact Analysis (SEIS) does account for such potential introductions of new BEV models in these model years.

exposure to air pollution (whether climate-exacerbated or not), and mitigate economic damages attributable to changes in the global climate and air pollution levels.

This section provides an overview of how we develop the assumptions and parameters used to estimate emissions of criteria air pollutants, greenhouse gases, and air toxics. It also describes how we develop and apply estimates of the air quality and climate-related impacts of these emissions and their consequences for human health, focusing particularly on the rule's effects on emissions of criteria air pollutants that cause poor air quality and can damage human health. The agency's analysis utilizes the "emissions inventory" approach to estimate these impacts. Vehicle-related emissions inventories are often described as three-legged stools, since they depend on measures of vehicle activity (*i.e.*, miles traveled, hours operated, or gallons of fuel burned), the number of vehicles in use, and emission factors per unit of vehicle activity.

An emissions factor is a rate that measures the quantity of a pollutant released to the atmosphere per unit of vehicle activity.⁶¹² This analysis relies on vehicle-miles traveled (VMT) as its measure of vehicle activity, and emission rates are measured by emissions (in mass units) per vehicle-mile; the vehicle-related or "tailpipe" emission inventory for most pollutants is the product of their per-mile emissions factor and the appropriate estimate of the number of miles traveled. Exceptions include tailpipe emissions of sulfur oxides (SO_x) and carbon dioxide (CO₂), which are estimated by applying emissions factors per gallon of fuel consumed derived from the chemical properties of different fuels to the appropriate values of fuel consumption in gallons. Vehicle activity levels—both the number of miles traveled and the number of gallons of fuel consumed—are generated by the CAFE Model (as described in Sections III.E.3. and 4. above), while the per-mile and per-gallon emission factors have been extracted from other models developed by other Federal agencies. In this rulemaking, vehicle-related emissions also include those that occur throughout the process of supplying fuel and other forms of vehicle energy (such as electric power), and these are termed upstream emissions. The agency estimates these upstream emissions

from the volume or energy content of fuel supplied and consumed by cars and light trucks, together with factors that express emissions of air pollutants and GHGs in mass per unit of fuel volume (usually grams per gallon) or fuel energy (*e.g.*, grams per million Btu) supplied. Total upstream emissions of each pollutant are estimated as the product of the number of gallons of fuel supplied and the relevant per-gallon emission factor, or as the product of total energy supplied and emissions per unit of energy produced and delivered.

For this rule, vehicle tailpipe (sometimes called "downstream") and upstream emission factors as well as estimates of total emissions from both sources were developed independently using separate data sources. Tailpipe emission factors are estimated from the highway emissions model developed for use in regulatory analysis by the U.S. Environmental Protection Agency's (EPA) National Vehicle and Fuel Emissions Laboratory, known as the Motor Vehicle Emission Simulator (MOVES). Upstream emission factors are estimated from a lifecycle emissions model developed by the U.S. Department of Energy's (DOE) Argonne National Laboratory, the Greenhouse Gases, Regulated Emissions, and Energy Use in Transportation (GREET) Model.⁶¹³ For this final rule, we updated the CAFE Model to utilize data from the most current versions of each model, MOVES 3 and GREET 2021.

Adverse human health outcomes caused by exposure to harmful accumulations of criteria air pollutants, such as asthma episodes and respiratory or cardiovascular distress requiring hospitalization, are generally reported as incidences per ton of emissions of each pollutant (or its chemical precursors). The incidence per ton values used to estimate changes in health impacts were developed using several EPA studies and recently updated to better account for the specific sources of emissions estimated by the CAFE Model. Finally, EPA also applies estimates of the affected population's willingness to pay to avoid each incidence of these adverse health impacts and sums the results to obtain estimates of the economic cost of air pollutant emissions in dollars per ton, which can be interpreted as estimates of the economic benefit from reducing each ton of emissions of different

pollutants. Chapter 5 of the TSD accompanying this final rule includes a detailed discussion of the procedures we used to simulate the environmental impacts of the different regulatory alternatives that were considered, and the implementation of these procedures within the CAFE Model is discussed in detail in the supporting Model Documentation. Further discussion of how the health impacts of upstream and tailpipe emissions of criteria air pollutants have been monetized and the resulting values used in this analysis can be found in Section III.G.2.b)(2). The Final SEIS accompanying this analysis also includes a detailed discussion of both criteria pollutant and GHG emissions and their impacts on human health as well as on the natural environment.

1. Activity Levels Used To Calculate Emissions Impacts

The CAFE Model estimates the annual number of miles driven (VMT) for each individual car and light truck model produced in every future model year at each age over their lifetimes, which extend for a maximum of 40 years. Since a vehicle's age is equal to the current calendar year minus the model year in which it was originally produced, the age span of each vehicle model's lifetime corresponds to a sequence of 40 calendar years beginning in the calendar year corresponding to the model year it was produced.⁶¹⁴ These estimates reflect the gradual decline in the fraction of each car and light truck model's original model year production volume that is expected to remain in service during each year of its lifetime, as well as the well-documented decline in their typical use as they age. Using this relationship, the CAFE Model calculates total VMT for cars and light trucks in service during each calendar year spanned in this analysis.

Based on these estimates, the model also calculates quantities of each type of fuel or energy, including gasoline, diesel, and electricity, consumed in each calendar year. By combining these with estimates of each model's fuel or energy efficiency, the model also estimates the quantity and energy content of each type of fuel consumed (including gasoline, diesel, and electricity) by cars and light trucks at

⁶¹² U.S. EPA, Basics Information of Air Emissions Factors and Quantification, <https://www.epa.gov/air-emissions-factors-and-quantification/basic-information-air-emissions-factors-and-quantification>. (Accessed: March 15, 2022)

⁶¹³ U.S. Department of Energy, Argonne National Laboratory, Greenhouse gases, Regulated Emissions, and Energy use in Transportation (GREET) Model, Last Update: 11 Oct. 2021, <https://greet.es.anl.gov/>. (Accessed: March 15, 2022) Upstream emission factors for criteria air pollutants may be undercounted, but are nonetheless important.

⁶¹⁴ In practice, many vehicle models bearing a given model year designation become available for sale in the preceding calendar year, and their sales can extend through the calendar year following their designated model year as well. However, the CAFE Model does not attempt to distinguish between model years and calendar years; vehicles bearing a model year designation are assumed to be produced and sold in that same calendar year.

each age, or viewed another way, during each calendar year of their lifetimes. As with the accounting of VMT, these estimates of annual fuel or energy consumption for each vehicle model and model year combination are combined to calculate the total volume of each type of fuel or energy consumed during each calendar year, as well as its aggregate energy content.

The procedures the CAFE Model uses to estimate annual VMT for individual car and light truck models produced during each model year over their lifetimes and to combine these into estimates of annual fleet-wide travel during each future calendar year, together with the sources of its estimates of their survival rates and average use at each age, are described in detail in Section III.E.2. The data and procedures it employs to convert these estimates of VMT to fuel and energy consumption by individual model, and to aggregate the results to calculate total consumption and energy content of each fuel type during future calendar years, are also described in detail in that same section.

The model documentation accompanying this final rule also describes these procedures in detail.⁶¹⁵ The quantities of travel and fuel consumption estimated for the cross section of model years and calendar years constitutes a set of “activity levels” based on which the model calculates emissions. The model does so by multiplying activity levels by emission factors. As indicated in the previous section, the resulting estimates of vehicle use (VMT), fuel consumption, and fuel energy content are combined with emission factors drawn from various sources to estimate emissions of GHGs, criteria air pollutants, and airborne toxic compounds that occur throughout the fuel supply and distribution process, as well as during vehicle operation, storage, and refueling. Emission factors measure the mass of each GHG, or criteria pollutant emitted per vehicle-mile of travel, gallon of fuel consumed, or unit of fuel energy content. The following sections identifies the sources of these emission factors and explains in detail how the CAFE Model applies them to its estimates of vehicle travel, fuel use, and fuel energy consumption to estimate total annual emissions of each GHG, criteria pollutant, and airborne toxic.

⁶¹⁵ CAFE Model documentation is available at <https://www.nhtsa.gov/corporate-average-fuel-economy/compliance-and-effects-modeling-system>.

2. Simulating Upstream Emissions Impacts

Building on the methodology for simulating upstream emissions impacts used in prior CAFE rules, this final rule analysis uses emissions factors developed with the U.S. Department of Energy’s Greenhouse gases, Regulated Emissions, and Energy use in Transportation (GREET) Model, specifically GREET 2021.⁶¹⁶ The analysis includes emissions impacts estimates for regulated criteria pollutants,⁶¹⁷ greenhouse gases,⁶¹⁸ and air toxics.⁶¹⁹

The upstream emissions factors included in the CAFE Model input files include parameters for 2020 through 2050 in five-year intervals (*e.g.*, 2020, 2025, 2030, and so on). For gasoline and diesel fuels, each analysis year includes upstream emissions factors for the four following upstream emissions processes: Petroleum extraction, petroleum transportation, petroleum refining, and fuel transportation, storage, and distribution (TS&D). In contrast, the upstream electricity emissions factor is only a single value per analysis year. We briefly discuss the components included in each upstream emissions factor here, and a more detailed discussion is included in Chapter 5 of the TSD accompanying this rule and the CAFE Model Documentation.

The first step in the process for calculating upstream emissions includes any emissions related to the extraction, recovery, and production of petroleum-based feedstocks, namely conventional crude oil, oil sands, and shale oils. Then, the petroleum transportation process accounts for the transport processes of crude feedstocks sent for domestic refining. The petroleum refining calculations are based on the aggregation of fuel blendstock processes rather than the crude feedstock processes, like the petroleum extraction and petroleum transportation calculations. The final upstream process after refining is the transportation, storage, and distribution (TS&D) of the finished fuel product.

⁶¹⁶ U.S. Department of Energy, Argonne National Laboratory, Greenhouse gases, Regulated Emissions, and Energy use in Transportation (GREET) Model, Last Update: 11 Oct. 2021, <https://greet.es.anl.gov/>.

⁶¹⁷ Carbon monoxide (CO), volatile organic compounds (VOCs), nitrogen oxides (NO_x), sulfur oxides (SO_x), and particulate matter with 2.5-micron (µm) diameters or less (PM_{2.5}).

⁶¹⁸ Carbon dioxide (CO₂), methane (CH₄), and nitrous oxide (N₂O).

⁶¹⁹ Acetaldehyde, acrolein, benzene, butadiene, formaldehyde, diesel particulate matter with 10-micron (µm) diameters or less (PM₁₀).

The upstream gasoline and diesel emissions factors are aggregated in the CAFE Model based on the share of fuel savings leading to reduced domestic oil fuel refining and the share of reduced domestic refining from domestic crude oil.⁶²⁰ The CAFE Model applies a fuel savings adjustment factor to the petroleum refining process and a combined fuel savings and reduced domestic refining adjustment to both the petroleum extraction and petroleum transportation processes for both gasoline and diesel fuels and for each pollutant. These adjustments are consistent across fuel types, analysis years, and pollutants, and are unchanged from the previous CAFE analyses. Additional discussion of the methodology for estimating the share of fuel savings leading to reduced domestic oil refining is located in Chapter 6.2.4.4 of the TSD.

Upstream electricity emissions factors are also calculated using GREET 2021. GREET 2021 projects a national default electricity generation mix for transportation use from the latest Annual Energy Outlook (AEO) data.⁶²¹ As discussed above, the CAFE Model uses a single upstream electricity factor for each analysis year.

The Environmental Defense Fund (EDF) submitted comments to the Draft SEIS docket stating that NHTSA’s estimates of reductions in global GHG emissions associated with lower domestic consumption of gasoline and diesel and its consequences for U.S. imports of crude petroleum should incorporate empirical estimates of the specific sources of U.S. imports that would be reduced and the rates of GHG emissions associated with producing crude petroleum at each of those sources and transporting it to the U.S. for refining.⁶²²

We do not have the detailed production and supply modeling capability that would be necessary to estimate reductions in U.S. imports of crude petroleum from specific sources, and the global nature of the market for crude petroleum suggests that those reductions are unlikely to be proportional to the volumes currently imported from different sources, as EDF

⁶²⁰ Upstream emissions are underestimated to the extent that they do not account for any toxic pollutants (like mercury) and criteria pollutants (*i.e.*, from refining/production in Mexico/Canada, as such pollutants can cross boundaries), as well as certain greenhouse gas emissions, that originate outside the borders of the United States and are attributable to changes in gasoline consumption as a result of these standards.

⁶²¹ For this CAFE analysis, this was AEO 2021, released February 3, 2021, <https://www.eia.gov/outlooks/archive/aeo21>.

⁶²² EDF, NHTSA–2021–0054–0016, at pp. 4–5.

appears to assume. The global nature of the market for crude petroleum also means that reductions in U.S. purchases from specific sources would not necessarily be met by corresponding reductions in petroleum production and associated GHG emissions at those locations, since those producers' reduced exports to the U.S. might simply be redirected to supply other purchasers.

In light of this situation, we believe the most reasonable assumption to use for estimating reductions in global GHG emissions associated with lower U.S. petroleum imports and global production is to apply the emission factors associated with crude petroleum production at different global locations and with current transportation patterns, weighted by each location's projected contribution to future global production. This is in fact the assumption implicitly reflected in the agency's reliance on GHG emission factors for crude petroleum transportation and distribution derived using GREET. Even this assumption is likely to lead to an overestimate of the reduction in global GHG emissions, since it implies that the estimated decline in U.S. imports will be fully reflected in an overall reduction in global petroleum production, rather than being partly or fully absorbed by other oil-consuming nations. We have therefore elected to retain this assumption and its current procedure for estimating reduced GHG emissions from petroleum production. These assumptions are discussed in further detail in Section 0.

EDF also commented that that NHTSA's estimates of reductions in domestic emissions of criteria air pollutants resulting from lower U.S. production and consumption of transportation fuels and its assumed effect on U.S. petroleum imports should include reductions in emissions that occur during the transportation of imported petroleum ". . . on U.S. soil or within established distances from our borders where emissions still affect U.S. ambient air quality." This would include emissions by tanker ships operating within U.S. Emission Control Areas (ECAs, which can extend as far as 200 miles from U.S. shores), including those to which petroleum is transferred when large oceangoing tankers cannot enter some U.S. ports, as well as emissions by petroleum-carrying barges, rail tank cars, and pipelines operating within U.S. borders.

In fact, our analysis does include emissions that occur during transportation of crude petroleum as domestic emissions associated with

petroleum imports. In effect, it assumes that transportation modes and shipment distances for moving crude petroleum from U.S. coastal ports to domestic refineries are similar to those for moving domestically extracted crude petroleum from oilfields or other domestic petroleum production facilities to U.S. refineries. Thus, some reductions in emissions that occur during transportation of imported crude petroleum within U.S. coastal and interior areas are included in the agency's estimates of total reductions in domestic emissions of criteria pollutants attributable to reduced U.S. petroleum imports. The agency believes this approach provides a satisfactory substitute for detailed estimation of movement distances and shipment modes for carrying imported crude petroleum from ports to refineries. This is discussed further in TSD Chapter 5.2 and TSD Chapter 6.2.4.2.

3. Simulating Tailpipe Emissions Impacts

Tailpipe emission factors are generated using a regulatory model for on-road emission inventories from the U.S. Environmental Protection Agency, the Motor Vehicle Emission Simulator (MOVES3), November 2020 release. MOVES3 is a state-of-the-science, mobile-source emissions inventory model for regulatory applications.⁶²³ MOVES3 tailpipe emission factors have been incorporated into the CAFE parameters, and these updates supersede tailpipe data previously provided by EPA from MOVES2014 for past CAFE analyses. MOVES3 accounts for a variety of processes related to emissions impacts from vehicle use, examples include exhaust and evaporative processes, among others.⁶²⁴

The CAFE Model uses tailpipe emissions factors for all model years from 2020 to 2060 for criteria pollutants and air toxics. To maintain continuity in the historical inventories, only emission factors for MYs 2020 and after were updated; all emission factors prior to MY 2020 were unchanged from previous CAFE rulemakings. In addition, the updated tailpipe data in the current CAFE reference case no longer account for any fuel economy improvements or changes in vehicle

miles traveled from the 2020 final rule. In order to avoid double-counting effects from the previous rulemaking in the current rulemaking, the tailpipe baseline backs out 1.5 percent year-over-year stringency increases in fuel economy, and 0.3 percent VMT increases assumed each year (20 percent rebound on the 1.5 percent improvements in stringency). Note that the MOVES3 data do not cover all the model years and ages required by the CAFE Model; MOVES only generates emissions data for vehicles made in the last 30 model years for each calendar year being run. This means emissions data for some calendar year and vehicle age combinations are missing. To remedy this, we take the last vehicle age that has emissions data and forward fill those data for the following vehicle ages. Due to incomplete available data for years prior to MY 2020, tailpipe emission factors for MY 2019 and earlier have not been modified and continue to utilize MOVES2014 data.

For tailpipe CO₂ emissions, these factors are defined based on the fraction of each fuel type's mass that represents carbon (the carbon content) along with the mass density per unit of the specific type of fuel. To obtain the emission factors associated with each fuel, the carbon content is then multiplied by the mass density of a particular fuel as well as by the ratio of the molecular weight of carbon dioxide to that of elemental carbon. This ratio, a constant value of 44/12, measures the mass of carbon dioxide that is produced by complete combustion of mass of carbon contained in each unit of fuel. The resulting value defines the emission factor attributed to CO₂ as the amount of grams of CO₂ emitted during vehicle operation from each type of fuel. This calculation is repeated for gasoline, E85, diesel, and compressed natural gas (CNG) fuel types. In the case of CNG, the mass density and the calculated CO₂ emission factor are denoted as grams per standard cubic feet (scf), while for the remainder of fuels, these are defined as grams per gallon of the given fuel source. Since electricity and hydrogen fuel types do not cause CO₂ emissions to be emitted during vehicle operation, the carbon content, and the CO₂ emission factors for these two fuel types are assumed to be zero. The mass density, carbon content, and CO₂ emission factors for each fuel type are defined in the Parameters file.

The CAFE Model calculates CO₂ tailpipe emissions associated with vehicle operation of the surviving on-road fleet by multiplying the number of gallons (or scf for CNG) of a specific fuel consumed by the CO₂ emissions factor

⁶²³ U.S. Environmental Protection Agency, Office of Transportation and Air Quality, Motor Vehicle Emission Simulator (MOVES), Last Updated: September 2021, <https://www.epa.gov/moves/latest-version-motor-vehicle-emission-simulator-moves>. For the CAFE analysis, MOVES 3.0.1 was used to generate the emission factors.

⁶²⁴ For CAFE modeling, the post-processing of emission factors for PM_{2.5} included exhaust processes (running, start, crankcase running, and crankcase start) and excluded brake and tire wear.

for the associated fuel type. More specifically, the amount of gallons or scf of a particular fuel are multiplied by the carbon content and the mass density per unit of that fuel type, and then the model applies the ratio of carbon dioxide emissions generated per unit of carbon consumed during the combustion process.⁶²⁵

4. Estimating Health Impacts From Changes in Criteria Pollutant Emissions

The CAFE Model computes select health impacts resulting from three criteria pollutants: NO_x, SO_x,⁶²⁶ and PM_{2.5}. Out of the six criteria pollutants currently regulated, NO_x, SO_x, and PM_{2.5} are known to be emitted regularly from mobile sources and have the most adverse effects to human health. These health impacts include several different morbidity measures, as well as a mortality estimate, and are measured by the number of instances predicted to occur per ton of emitted pollutant.⁶²⁷ The model reports total health impacts by multiplying the estimated tons of each criteria pollutant by the corresponding health incidence per ton value. The inputs that inform the calculation of the total tons of emissions resulting from criteria pollutants are discussed above. This section discusses how the health incidence per ton values were obtained. See Section III.G.2.b(2) and Chapter 6.2.2 of the TSD accompanying this notice for information regarding the monetized damages arising from these health impacts.

The Final SEIS associated with this document also includes a detailed discussion of the criteria pollutants and air toxics analyzed and their potential health effects. Consistent with past analyses, we have performed full-scale photochemical air quality modeling and presented those results in the Final SEIS. That analysis provides additional assessment of the human health impacts from changes in PM_{2.5} and ozone associated with this rule. We note that compliance with CAFE standards is based on the average performance of manufacturers' production for sale

⁶²⁵ Chapter 3, Section 4 of the CAFE Model Documentation provides additional description for calculation of CO₂ tailpipe emissions with the model.

⁶²⁶ Any reference to SO_x in this section refers to the sum of sulfur dioxide (SO₂) and sulfate particulate matter (pSO₄) emissions, following the methodology of the EPA papers cited.

⁶²⁷ The complete list of morbidity impacts estimated in the CAFE Model is as follows: acute bronchitis, asthma exacerbation, cardiovascular hospital admissions, lower respiratory symptoms, minor restricted activity days, non-fatal heart attacks, respiratory emergency hospital admissions, respiratory emergency room visits, upper respiratory symptoms, and work loss days.

throughout the U.S., and that the FRIA involves sensitivity analysis spanning a range of model inputs, many of which impact estimates of future emissions from passenger cars and light trucks. Chapter 6 of the FRIA includes a discussion of overall changes in health impacts associated with criteria pollutant changes across the different rulemaking scenarios.

In previous rulemakings, health impacts were split into two categories based on whether they arose from upstream emissions or tailpipe emissions. In the current analysis, these health incidence per ton values have been updated to reflect the differences in health impacts arising from each emission source sector, according to the latest publicly available EPA reports that appropriately correspond to these sectors. Five different upstream emission source sectors (petroleum extraction, petroleum transportation, refineries, fuel transportation, storage and distribution, and electricity generation) are now represented. The tailpipe source sector is now disaggregated based on fuel and vehicle type. As the health incidences for the different source sectors are all based on the emission of one ton of the same pollutants, NO_x, SO_x, and PM_{2.5}, the differences in the incidence per ton values arise from differences in the geographic distribution of the pollutants, a factor which affects the number of people impacted by the pollutants.⁶²⁸

The CAFE Model health impacts inputs are based partially on the structure of EPA's 2018 TSD, Estimating the Benefit per Ton of Reducing PM_{2.5} Precursors from 17 Sectors (referred to here as the 2018 EPA source apportionment TSD),⁶²⁹ which reported benefit per ton values for the years 2016, 2020, 2025, and 2030.⁶³⁰ For the years in between the source years used in the input structure, the CAFE Model applies values from the closest source year. For instance, 2020 values are applied for 2020–2022, and 2025 values are applied for 2023–2027. For further details, see the CAFE Model documentation, which contains a description of the model's

⁶²⁸ See Environmental Protection Agency (EPA). 2018. Estimating the Benefit per Ton of Reducing PM_{2.5} Precursors from 17 Sectors. https://www.epa.gov/sites/production/files/2018-02/documents/sourceapportionmentbptsd_2018.pdf.

⁶²⁹ Environmental Protection Agency (EPA). 2018. Estimating the Benefit per Ton of Reducing PM_{2.5} Precursors from 17 Sectors. https://www.epa.gov/sites/production/files/2018-02/documents/sourceapportionmentbptsd_2018.pdf.

⁶³⁰ As the year 2016 is not included in this analysis, the 2016 values were not used.

computation of health impacts from criteria pollutant emissions.

Despite efforts to be as consistent as possible between the upstream emissions sectors utilized in the CAFE Model with the 2018 EPA source apportionment TSD, the need to use up-to-date sources based on newer air quality modeling updates led to the use of multiple papers. In addition to the 2018 EPA source apportionment TSD used in the 2020 final rule, we used additional EPA sources and conversations with EPA staff to appropriately map health incidence per ton values to the appropriate CAFE Model emissions source category. Very recently, EPA updated its approach to estimating the benefits of changes in PM_{2.5} and ozone,^{631 632} as well as the associated changes in health impacts per ton. These updates were based on information drawn from the recent 2019 PM_{2.5} and 2020 Ozone Integrated Science Assessments (ISAs), which were reviewed by the Clean Air Science Advisory Committee (CASAC) and the public.^{633 634} EPA has not updated its health incidence estimates for mobile sources to reflect these updates in time for this analysis. Instead, based on the recommendation of EPA staff, we use the same PM_{2.5} BPT estimates and health incidence values that we used in the NPRM, to ensure consistency between the values corresponding to different source sectors. The estimates used are based on the review of the 2009 PM ISA⁶³⁵ and 2012 p.m. ISA Provisional Assessment⁶³⁶ and include

⁶³¹ U.S. Environmental Protection Agency (U.S. EPA). 2021a. Regulatory Impact Analysis for the Final Revised Cross-State Air Pollution Rule (CSAPR) Update for the 2008 Ozone NAAQS. EPA-452/R-21-002. March.

⁶³² U.S. Environmental Protection Agency (U.S. EPA). 2021b. Estimating PM_{2.5} and Ozone-Attributable Health Benefits. Technical Support Document (TSD) for the Final Revised Cross-State Air Pollution Rule Update for the 2008 Ozone Season NAAQS. EPA-HQ-OAR-2020-0272. March.

⁶³³ U.S. Environmental Protection Agency (U.S. EPA). 2019a. Integrated Science Assessment (ISA) for Particulate Matter (Final Report, 2019). U.S. Environmental Protection Agency, Washington, DC, EPA/600/R-19/188, 2019.

⁶³⁴ U.S. Environmental Protection Agency (U.S. EPA). 2019a. Integrated Science Assessment (ISA) for Ozone and Related Photochemical Oxidants (Final Report). U.S. Environmental Protection Agency, Washington, DC, EPA/600/R-20/012, 2020.

⁶³⁵ U.S. Environmental Protection Agency (U.S. EPA). 2009. Integrated Science Assessment for Particulate Matter (Final Report). EPA-600-R-08-139F. National Center for Environmental Assessment-RTP Division, Research Triangle Park, NC. December. Available at: <http://cfpub.epa.gov/ncsa/cfm/recordisplay.cfm?deid=216546>.

⁶³⁶ U.S. Environmental Protection Agency (U.S. EPA). 2012. Provisional Assessment of Recent Studies on Health Effect of Particulate Matter Exposure. EPA/600/R-12/056F. National Center for Environmental Assessment-RTP Division, Research

a mortality risk estimate derived from the Krewski et al. (2009)⁶³⁷ analysis of the American Cancer Society (ACS) cohort and nonfatal illnesses consistent with benefits analyses performed for the analysis of the final Tier 3 Vehicle Rule (79 FR 23414, April 28, 2014),⁶³⁸ the final 2012 p.m. NAAQS Revision (78 FR 3154, Jan. 15, 2013),⁶³⁹ and the final 2017–2025 Light-duty Vehicle GHG Rule (77 FR 62624, Oct. 15, 2012).⁶⁴⁰ We expect this lag in updating our health incidence and BPT estimates to have only a minimal impact on total PM benefits, since the underlying mortality risk estimate based on the Krewski study is identical to an updated PM_{2.5} mortality risk estimate derived from an expanded analysis of the same ACS cohort. We are aware of EPA's work to update its mobile source BPT and health incidence estimates to reflect these recent updates for use in future rulemaking analyses, and we will work further with EPA in future rulemakings to update and synchronize approaches.

The basis for the health impacts from the petroleum extraction sector is a 2018 oil and natural gas sector paper written by EPA staff (Fann et al.), which estimates health impacts for this sector in the year 2025.⁶⁴¹ This paper defines the oil and gas sector's emissions not only as arising from petroleum extraction but also from transportation to refineries, while the CAFE/GREET component is composed of only petroleum extraction. After consultation

Triangle Park, NC. December. Available at: <https://cfpub.epa.gov/ncea/isa/recordisplay.cfm?deid=247132>.

⁶³⁷ Krewski D., M. Jerrett, R.T. Burnett, R. Ma, E. Hughes, Y. Shi, et al. 2009. Extended Follow-Up and Spatial Analysis of the American Cancer Society Study Linking Particulate Air Pollution and Mortality. HEI Research Report, 140, Health Effects Institute, Boston, MA.

⁶³⁸ U.S. Environmental Protection Agency (2014). Control of Air Pollution from Motor Vehicles: Tier 3 Motor Vehicle Emission and Fuel Standards Final Rule: Regulatory Impact Analysis, Assessment and Standards Division, Office of Transportation and Air Quality, EPA-420-R-14-005, March 2014. Available on the internet: <http://www3.epa.gov/otaq/documents/tier3/420r14005.pdf>.

⁶³⁹ U.S. Environmental Protection Agency. (2012). Regulatory Impact Analysis for the Final Revisions to the National Ambient Air Quality Standards for Particulate Matter, Health and Environmental Impacts Division, Office of Air Quality Planning and Standards, EPA-452-R-12-005, December 2012. Available on the internet: <http://www3.epa.gov/ttnecas1/regdata/RIAs/finalria.pdf>.

⁶⁴⁰ U.S. Environmental Protection Agency (U.S. EPA). (2012). Regulatory Impact Analysis: Final Rulemaking for 2017–2025 Light-Duty Vehicle Greenhouse Gas Emission Standards and Corporate Average Fuel Economy.

⁶⁴¹ Fann, N., Baker, K. R., Chan, E., Eyth, A., Macpherson, A., Miller, E., & Snyder, J. (2018). Assessing Human Health PM_{2.5} and Ozone Impacts from U.S. Oil and Natural Gas Sector Emissions in 2025. Environmental science & technology, 52(15), 8095–8103 (hereinafter, Fann et al.).

with the authors of the EPA paper, we determined that these are the best available estimates for the petroleum extraction sector, notwithstanding this difference. Specific health incidences per pollutant were not reported in the paper, so EPA staff sent BenMAP health incidence files for the oil and natural gas sector upon request. DOT staff then calculated per ton values based on these files and the tons reported in the Fann et al. paper.⁶⁴² The only available health impacts corresponded to the year 2025. Rather than trying to extrapolate, these 2025 values were used for all the years in the CAFE Model structure: 2020, 2025, and 2030.⁶⁴³ This simplification implies an overestimate of damages in 2020 and an underestimate in 2030.⁶⁴⁴

We understand that uncertainty exists around the contribution of VOCs to PM_{2.5} formation in the modeled health impacts from the petroleum extraction sector; however, based on feedback to the 2020 final rule, we believe that the updated health incidence values specific to petroleum extraction sector emissions may provide a more appropriate estimate of potential health impacts from that sector's emissions than the previous approach of applying refinery sector emissions impacts to the petroleum extraction sector. For further discussion of the BPT estimates corresponding to the health effects discussed in this section, see Section III.G.2.b)(2).

The petroleum transportation sector and fuel TS&D sector do not correspond to any one EPA source sector in the 2018 EPA source apportionment TSD, so we use a weighted average of multiple different EPA sectors to determine the health impact per ton values for those sectors. We use a combination of different EPA mobile source sectors from two different papers, the 2018 EPA source

⁶⁴² Nitrate-related health incidents were divided by the total tons of NO_x projected to be emitted in 2025, sulfate-related health incidents were divided by the total tons of projected SO_x, and EC/OC (elemental carbon and organic carbon) related health incidents were divided by the total tons of projected EC/OC. Both Fann et al. and the 2018 EPA source apportionment TSD define primary PM_{2.5} as being composed of elemental carbon, organic carbon, and small amounts of crustal material. Thus, the EC/OC BenMAP file was used for the calculation of the incidents per ton attributable to PM_{2.5}.

⁶⁴³ These three years are used in the CAFE Model structure because it was originally based on the estimate provided in the 2018 EPA source apportionment TSD.

⁶⁴⁴ See EPA. 2018. Estimating the Benefit per Ton of Reducing PM_{2.5} Precursors from 17 Sectors. https://www.epa.gov/sites/production/files/2018-02/documents/sourceapportionmentbpttsd_2018.pdf, p. 9.

apportionment TSD,⁶⁴⁵ and a 2019 mobile source sectors paper (Wolfe et al.)⁶⁴⁶ to generate these values. The health incidence per ton values associated with the refineries sector and electricity generation sector are drawn solely from the 2018 EPA source apportionment TSD.

IPI expressed concern that the agency's domestic fuel refining share assumptions cause an underestimate in the health effects counted in this analysis.⁶⁴⁷ For discussion of NHTSA's domestic fuel refining assumptions, see Section III.G.2.b)(3), TSD Chapter 5.2, and TSD Chapter 6.2.

The CAFE Model follows a similar process for computing health impacts resulting from tailpipe emissions as it does for calculating health impacts from upstream emissions. Previous rulemakings used the 2018 EPA source apportionment TSD as the source for the health incidence per ton, matching the CAFE Model tailpipe emissions inventory to the "on-road mobile sources sector" in the TSD. However, a more recent EPA paper from 2019 (Wolfe et al.)⁶⁴⁸ computes monetized damage costs per ton values at a more disaggregated level, separating on-road mobile sources into multiple categories based on vehicle type and fuel type. Wolfe et al. did not report incidences per ton, but that information was obtained through communications with EPA staff. The Center for Biological Diversity, Chesapeake Bay Foundation, Conservation Law Foundation, Earthjustice, Environmental Law & Policy Center, Natural Resources Defense Council, Public Citizen, Inc., Sierra Club, and Union of Concerned Scientists, in their joint summary comments, stated that the estimates of the benefits of PM_{2.5} reductions have been improved with the addition of the Wolfe et al. paper.⁶⁴⁹ We agree, and continue to use these sources in the final rulemaking analysis as the categories are more expansive and specific than the original 2018 source.

The Wisconsin Department of Natural Resources (WDNR) stated that "NHTSA

⁶⁴⁵ Environmental Protection Agency (EPA). 2018. Estimating the Benefit per Ton of Reducing PM_{2.5} Precursors from 17 Sectors. https://www.epa.gov/sites/production/files/2018-02/documents/sourceapportionmentbpttsd_2018.pdf.

⁶⁴⁶ Wolfe et al. 2019. Monetized health benefits attributable to mobile source emissions reductions across the United States in 2025. <https://pubmed.ncbi.nlm.nih.gov/30296769/>.

⁶⁴⁷ IPI, Docket No. NHTSA-2021-0053-1579, at 39.

⁶⁴⁸ Wolfe et al. 2019. Monetized health benefits attributable to mobile source emissions reductions across the United States in 2025. <https://pubmed.ncbi.nlm.nih.gov/30296769/>.

⁶⁴⁹ CBD et al., Docket No. NHTSA-2021-0053-1572, at 5.

should work with EPA to offset any increases in sulfur dioxide emissions associated with the rule” and that “NHTSA should work with EPA to offset any short-term increases in NO_x and VOC emissions associated with the rule,” specifically citing the on-road emissions that contribute to ozone formation in Wisconsin. Furthermore, they state that “NHTSA’s analysis should be updated to reflect EPA’s revised area designations for the 2015 ozone NAAQS.”⁶⁵⁰

While this final rulemaking will result in small short-term increases in criteria pollutants, the number of vehicle re-fueling events and emissions of certain criteria pollutants and precursors to the emissions impact will vary from area to area depending on factors such as the composition of the local vehicle fleet and the amount of gasoline produced in the area. As discussed further in the Final SEIS, criteria pollutant impacts are by their nature diffuse and indeterminate, which makes the assessment of any potential mitigation measures difficult; however, NHTSA does not have jurisdiction to regulate criteria and air toxic pollutant emissions. However, as discussed further in the Final SEIS, NHTSA did update the Final SEIS analysis to reflect EPA’s revised area designations for the 2015 ozone NAAQS, including nonattainment area designations in Wisconsin and the Chicago area.

The Alliance for Automotive Innovation and CEI expressed the concern that the analysis overstates health effects. The Alliance argued that reductions in PM_{2.5} emissions “will not provide public health benefits that are additive to the emissions reductions accomplished by EPA’s mobile-source and stationary-source programs for criteria air pollutants.”⁶⁵¹ CEI objected to counting benefits from a reduction in PM emissions in areas that are not classified as nonattainment areas.⁶⁵² As EPA stated in their recent GHG final rule for MYs 2023–2026 (86 FR 74434,

Dec. 30, 2021),⁶⁵³ NAAQS are set with an “adequate margin of safety” but this “does not represent a zero-risk standard.” As such, it is important to count health benefits from reductions in criteria pollutants, regardless of whether they occur in nonattainment areas or not. Furthermore, the relative magnitude of the health benefits in our analysis is minimal compared to the other costs and benefits and does not significantly change net benefits.

We are aware of other limitations of using national values of health incidences per ton associated with the BPT approach, which we discuss extensively in prior rules, the NPRM, and Chapter 5 of the TSD. That said, we believe that the BPT approach provides a reasonable estimate of how different levels of CAFE standards may impact public health.

The methodology for generating values for each emissions category in the CAFE Model is discussed in further detail in Chapter 5 of the TSD. The Parameters file contains all of the health impact per ton of emissions values used in this final rule.

G. Simulating Economic Impacts of Regulatory Alternatives

This section summarizes the agency’s approach for measuring the economic costs and benefits that will result from establishing alternative CAFE standards for future model years. The benefit and cost measures the agency uses are important considerations, because as Office of Management and Budget (OMB) Circular A–4 states, benefits and costs reported in regulatory analyses must be defined and measured consistently with economic theory, and should also reflect how alternative regulations are anticipated to change the behavior of producers and consumers from a baseline scenario.⁶⁵⁴ For CAFE standards, those include vehicle manufacturers, buyers of new cars and light trucks, owners of used vehicles, and suppliers of fuel, all of whose

behavior is likely to respond in complex ways to the level of CAFE standards that DOT establishes for future model years.

It is important to report the benefits and costs of this final rule in a format that conveys useful information about how those impacts are generated and also distinguishes the impacts of those economic consequences for private businesses and households from the effects on the remainder of the U.S. economy. A reporting format will accomplish this objective to the extent that it clarifies who incurs the benefits and costs of the final rule, and shows how the economy-wide or “social” benefits and costs of the final rule are composed of its direct effects on vehicle producers, buyers, and users, plus the indirect or “external” benefits and costs it creates for the general public.

Table III–37 and Table III–38 present the incremental economic benefits and costs of the final rule and the alternatives (described in detail in Section IV) to increase CAFE standards for MYs 2024–26 at three percent and seven percent discount rates in a format that is intended to meet these objectives. The tables include costs that are transfers between different economic actors—these will appear as both a cost and a benefit in equal amounts (to separate affected parties). Societal cost and benefit values shown elsewhere in this document do not show costs that are transfers for the sake of simplicity but report the same net societal costs and benefits. The final rule and the alternatives would increase costs to manufacturers for adding technology necessary to enable new cars and light trucks to comply with fuel economy and emission regulations. It may also increase fine payments by manufacturers who would have achieved compliance with the less demanding baseline standards. Manufacturers are assumed to transfer these costs on to buyers by charging higher prices; although this reduces their revenues, on balance, the increase in compliance costs and higher sales revenue leaves them financially unaffected. Since the analysis assumes that manufacturers are left in the same economic position regardless of the standards, they are excluded from the tables.

BILLING CODE 4910–59–P

⁶⁵⁵ Average SC–GHG values are constructed using a 3 percent discount rate and are discounted back to present value using a 3 percent discount rate.

⁶⁵⁶ OMB Circular A–4, at 37–38.

⁶⁵⁷ CBD et al., Appendix, Docket No. NHTSA–2021–0053–1572, at 31.

⁶⁵⁸ IPI, at 30; Jacobsen and Liao, at 2.

⁶⁵³ EPA. Revised 2023 and Later Model Year Light-Duty Vehicle Greenhouse Gas Emissions Standards: Response to Comments (EPA–420–R–21–027, December 2021) pp. 15–31.

⁶⁵⁴ White House Office of Management and Budget, *Circular A–4: Regulatory Analysis*, September 17, 2003 (https://obamawhitehouse.archives.gov/omb/circulars_a004_a-4/), Section E.

Table III-37 – Incremental Monetized Benefits and Costs Over the Lifetimes of Total Fleet Produced Through 2029 (2018\$ Billions), 3 Percent Discount Rate, by Alternative, Average SC-GHG⁶⁵⁵

Alternative	1	2	2.5	3
Private Costs				
Technology Costs to Increase Fuel Economy	31.7	67.4	76.4	100.2
Increased Maintenance and Repair Costs	0.0	0.0	0.0	0.0
Opportunity Cost in Other Vehicle Attributes	0.0	0.0	0.0	0.0
Consumer Surplus Loss from Reduced New Vehicle Sales	0.0	0.2	0.3	0.5
Safety Costs Internalized by Drivers	5.0	7.9	8.7	10.7
Subtotal - Incremental Private Costs	36.7	75.4	85.4	111.4
External Costs				
Congestion and Noise Costs from Rebound-Effect Driving	6.1	9.8	10.8	13.0
Safety Costs Not Internalized by Drivers	4.5	8.8	9.7	12.8
Loss in Fuel Tax Revenue	11.3	20.0	22.4	28.6
Subtotal - Incremental External Costs	21.9	38.5	43.0	54.4
Total Incremental Social Costs	58.6	113.9	128.4	165.8
Private Benefits				
Reduced Fuel Costs	52.5	88.1	98.2	123.5
Benefits from Additional Driving	9.9	14.9	16.4	19.8
Less Frequent Refueling	0.3	-1.3	-0.8	0.1
Subtotal - Incremental Private Benefits	62.7	101.7	113.8	143.4
External Benefits				
Reduction in Petroleum Market Externality	0.9	1.6	1.8	2.3
Reduced Climate Damages, Average SC-GHG	14.4	24.6	27.5	34.8
Reduced Health Damages	1.2	1.5	1.5	1.7
Subtotal - Incremental External Benefits	16.5	27.7	30.8	38.8
Total Incremental Social Benefits, Average SC-GHG	79.2	129.4	144.6	182.2
Net Incremental Social Benefits, Average SC-GHG				
	20.6	15.5	16.3	16.4

⁶⁵⁵ Average SC-GHG values are constructed using a 3 percent discount rate and are discounted back to present value using a 3 percent discount rate.

Table III-38 – Incremental Benefits and Costs Over the Lifetimes of Total Fleet Produced Through 2029 (2018\$ Billions), 7 Percent Discount Rate, by Alternative, Average SC-GHG

Alternative	1	2	2.5	3
Private Costs				
Technology Costs to Increase Fuel Economy	25.8	54.7	62.0	81.4
Increased Maintenance and Repair Costs	0.0	0.0	0.0	0.0
Opportunity Cost in Other Vehicle Attributes	0.0	0.0	0.0	0.0
Consumer Surplus Loss from Reduced New Vehicle Sales	0.0	0.2	0.2	0.4
Safety Costs Internalized by Drivers	3.0	4.8	5.3	6.5
Subtotal - Incremental Private Costs	28.8	59.6	67.5	88.2
External Costs				
Congestion and Noise Costs from Rebound-Effect Driving	3.9	6.3	7.1	8.5
Safety Costs Not Internalized by Drivers	3.1	6.3	7.1	9.4
Loss in Fuel Tax Revenue	7.2	12.7	14.2	18.1
Subtotal - Incremental External Costs	14.2	25.3	28.3	36.0
Total Incremental Social Costs	43.0	84.9	95.8	124.3
Private Benefits				
Reduced Fuel Costs	32.7	54.7	61.0	76.7
Benefits from Additional Driving	6.0	9.1	10.0	12.1
Less Frequent Refueling	0.1	-0.9	-0.6	-0.1
Subtotal - Incremental Private Benefits	38.8	62.9	70.3	88.8
External Benefits				
Reduction in Petroleum Market Externality	0.5	1.0	1.1	1.4
Reduced Climate Damages, Average SC-GHG	14.4	24.6	27.5	34.8
Reduced Health Damages	0.7	0.8	0.8	0.9
Subtotal - Incremental External Benefits	15.6	26.4	29.4	37.0
Total Incremental Social Benefits, Average SC-GHG	54.5	89.3	99.7	125.8
Net Incremental Social Benefits, Average SC-GHG				
	11.5	4.3	3.9	1.5

BILLING CODE 4910-59-C

Compared to the baseline standards, the analysis shows that buyers of new cars and light trucks will incur higher purchasing prices and financing costs, which will lead to some buyers dropping out of the new vehicle market. Drivers of new vehicles will also experience a slight uptick in the risk of being injured in a crash because of mass reduction technologies employed to meet the increased standards. While this effect is not statistically significant, NHTSA provides these results for transparency, and to demonstrate that their inclusion does not affect NHTSA's policy decision. Because of the increasing price of new vehicles, some owners may delay retiring and replacing their older vehicles with newer models.

In effect, this will transfer some driving that would have been done in newer vehicles under the baseline scenario to older models within the legacy fleet, thus increasing costs for injuries (both fatal and less severe) and property damages sustained in motor vehicle crashes. This stems from the fact that cars and light trucks have become progressively more protective in crashes over time (and also slightly less prone to certain types of crashes, such as rollovers). Thus, shifting some travel from newer to older models would increase injuries and damages sustained by drivers and passengers because they are traveling in less safe vehicles and not because it changes the risk profiles of drivers themselves. These costs are largely driven by assumptions regarding

consumer valuation of fuel efficiency and an assumption that more fuel-efficient vehicles are less preferable to consumers than their total cost to improve fuel economy. The agency examines alternate assumptions regarding consumer valuation, as well as other assumptions that influence our safety impact estimates in a sensitivity analysis that can be found in the accompanying FRIA.

In exchange for these costs, consumers will benefit from new cars and light trucks with better fuel economy. Drivers will experience lower costs as a consequence of new vehicles' decreased fuel consumption, and from fewer refueling stops required because of their increased driving range. They will experience mobility benefits as they

use newly purchased cars and light trucks more in response to their lower operating costs. On balance, consumers of new cars and light trucks produced during the model years subject to this final rule will experience significant economic benefits.

Table III–37 and Table III–38 also show that the changes in fuel consumption and vehicle use resulting from this final rule will in turn generate both benefits and costs to society writ large. These impacts are “external,” in the sense that they are by-products of decisions by private firms and individuals that alter vehicle use and fuel consumption but are experienced broadly throughout society rather than by the firms and individuals who indirectly cause them. In terms of costs, additional driving by consumers of new vehicles in response to their lower operating costs will increase the external costs associated with their contributions to traffic delays and noise levels in urban areas, and these additional costs will be experienced throughout much of the society. While most of the risk of additional driving or delaying purchasing a newer vehicle are internalized by those who make those decisions, a portion of the costs are borne by other road users. Finally, since owners of new vehicles will be consuming less fuel, they will pay less in fuel taxes.

Society will also benefit from more stringent standards. Increased fuel efficiency will reduce the amount of petroleum-based fuel consumed and refined domestically, which will decrease the emissions of carbon dioxide and other greenhouse gases that contribute to climate change, and, as a result, the U.S. (and the rest of world) will avoid some of the economic damages from future changes in the global climate. Similarly, reduced fuel production and use will decrease emissions of more localized air pollutants (or their chemical precursors), and the resulting decrease in the U.S. population’s exposure to harmful levels of these pollutants will lead to lower costs from its adverse effects on health. Decreasing consumption and imports of crude petroleum for refining lower volumes of gasoline and diesel will also create some benefits throughout the U.S., in potential gains in energy security as businesses and households that are dependent on fuel are less subject to sudden and sharp changes in energy prices.

On balance, Table III–37 and Table III–38 show that both consumers and society as a whole will experience net economic benefits from the final rule.

The following subsections will briefly describe the economic costs and benefits considered by the agency. For a complete discussion of the methodology employed and the results, see TSD Chapter 6 and FRIA Chapter 6, respectively. The safety implications of the final rule—including the monetary impacts—are addressed in Section III.H.

1. Private Costs and Benefits

(a) Costs to Consumers

(1) Technology Costs

The final rule and the alternatives would increase costs to manufacturers for adding technology necessary to enable new cars and light trucks to comply with fuel economy and emission regulations. Manufacturers are assumed to transfer these costs on to buyers by charging higher prices. See Section III.C.6 and TSD Chapter 2.6.

(2) Consumer Sales Surplus

Buyers who would have purchased a new vehicle with the baseline standards in effect but decide not to do so in response to the changes in new vehicles’ prices due to more stringent standards in place will experience a decrease in welfare. The collective welfare loss to those “potential” new vehicle buyers is measured by the forgone consumer surplus they would have received from their purchase of a new vehicle in the baseline.

Consumer surplus is a fundamental economic concept and represents the net value (or net benefit) a good or service provides to consumers. It is measured as the difference between what a consumer is willing to pay for a good or service and the market price. OMB Circular A–4 explicitly identifies consumer surplus as a benefit that should be accounted for in cost-benefit analysis. For instance, OMB Circular A–4 states the “net reduction in total surplus (consumer plus producer) is a real cost to society,” and elsewhere elaborates that consumer surplus values be monetized “when they are significant.”⁶⁵⁶

Accounting for the portion of fuel savings that the average new vehicle buyer demands, and holding all else equal, higher average prices should depress new vehicle sales and by extension reduce consumer surplus. The inclusion of consumer surplus is not only consistent with OMB guidance, but with other parts of the regulatory analysis. For instance, we calculate the increase in consumer surplus associated with increased driving that results from the decrease in the cost per mile of

operation under more stringent regulatory alternatives, as discussed in Section III.G.1.b(3). The surpluses associated with sales and additional mobility are inextricably linked as they capture the direct costs and benefits accrued by purchasers of new vehicles. The sales surplus captures the welfare loss to consumers when they forgo a new vehicle purchase in the presence of higher prices and the additional mobility measures the benefit increased mobility under lower operating expenses.

The agency estimates the loss of sales surplus based on the change in quantity of vehicles projected to be sold after adjusting for quality improvements attributable to fuel economy. For additional information about consumer sales surplus, see TSD Chapter 6.1.2.

(3) Ancillary Costs of Higher Vehicle Prices

Some costs of purchasing and owning a new or used vehicle scale with the value of the vehicle. Where fuel economy standards increase the transaction price of vehicles, they will affect both the absolute amount paid in sales tax and the average amount of financing required to purchase the vehicle. Further, where they increase the MSRP, they increase the appraised value upon which both value-related registration fees and a portion of insurance premiums are based. The analysis assumes that the transaction price is a set share of the MSRP, which allows calculation of these factors as shares of MSRP.

For this final rule, NHTSA has revised its estimates of these ancillary costs to correct some mistakes in their accounting. First, NHTSA excludes financing costs from the per-vehicle analysis. The availability of vehicle financing is, if anything, a benefit to consumers that would lower the cost to consumers of fuel-economy technology by spreading out the costs over time. Second, NHTSA has reduced its estimate of insurance costs to avoid a double-counting issue it identified. Specifically, a portion of the insurance premium goes to covering replacement vehicles and including that portion of the insurance cost would be duplicative with estimates of the upfront technology cost on the replacement vehicle (which is already captured in the analysis and discussed above). For a detailed explanation of how the agency estimates these costs, see TSD Chapter 6.1.1.

These costs are included in the consumer per-vehicle cost-benefit analysis but are not included in the societal cost-benefit analysis because they are assumed to be transfers from

⁶⁵⁶ OMB Circular A–4, at 37–38.

consumers to governments, financial institutions, and insurance companies.

(b) Benefits to Consumers

(1) Fuel Savings

The primary benefit to consumers of increasing CAFE standards are the additional fuel savings that accrue to new vehicle owners. Fuel savings are calculated by multiplying avoided fuel consumption by fuel prices. Each vehicle of a given body style is assumed to be driven the same as all the others of a comparable age and body style in each calendar year. The ratio of that cohort's VMT to its fuel efficiency produces an estimate of fuel consumption. The difference between fuel consumption in the baseline, and in each alternative, represents the gallons (or energy) saved. Under this assumption, our estimates of fuel consumption from increasing the fuel economy of each individual model depend only on how much its fuel economy is increased, and do not reflect whether its actual use differs from other models of the same body type. Neither do our estimates of fuel consumption account for variation in how much vehicles of the same body type and age are driven each year, which appears to be significant (see TSD Chapter 4.3.2). Consumers save money on fuel expenditures at the average retail fuel price (fuel price assumptions are discussed in detail in TSD Chapter 4.1.2), which includes all taxes and represents an average across octane blends. For gasoline and diesel, the included taxes reflect both the Federal tax and a calculated average state fuel tax. Expenditures on alternative fuels (E85 and electricity, primarily) are also included in the calculation of fuel expenditures, on which fuel savings are based. And while the included taxes net out of the social benefit cost analysis (as they are a transfer), consumers value each gallon saved at retail fuel prices including any additional fees such as taxes. See TSD Chapter 6.1.3 for additional details. In the TSD, the agency considers the possibility that several of the assumptions made about vehicle use could lead to imprecision in projecting fuel savings. The agency notes that these simplifying assumptions are necessary to model fuel savings and likely have minimal impact to the accuracy of this analysis.

CBD et al. commented that NHTSA underestimates the fuel savings in the analysis. CBD et al. argued that NHTSA needs to account for any fuel savings that may be achieved if CAFE standards cause gasoline prices to fall due to

decreasing demand.⁶⁵⁷ The agency acknowledges that if fuel prices do decrease as a result of this rule, the analysis could understate the amount of fuel savings. However, given how pervasive fuel price projections are within the analysis, other estimates would be incorrect as well. For example, our model assumes that manufacturers will apply technology if the fuel savings in the first 30 months exceeds the technology costs. If prices drop as a result of better fuel economy, our standards would have a larger, negative impact on sales as fewer technology costs are 'worth it' in the eyes of consumers. It is not readily apparent, then, whether holding fuel prices constant across alternatives would increase or decrease the net benefits attributable to the standards. Modeling fuel prices that respond dynamically is currently outside the ability of the model. Furthermore, since fuel prices are influenced by many different factors—many of which are outside the purview of United States—it's not clear if modeling gas prices dynamically would enhance the agency's analysis.

(2) Refueling Benefit

Increasing CAFE standards, all else being equal, affects the amount of time drivers spend refueling their vehicles in several ways. First, they increase the fuel economy of ICE vehicles produced in the future, which increases vehicle range and decreases the number of refueling events for those vehicles. Conversely, to the extent that more stringent standards increase the purchase price of new vehicles, they may reduce sales of new vehicles and scrappage of existing ones, causing more VMT to be driven by older and less efficient vehicles, which require more refueling events for the same amount of VMT driven. Finally, sufficiently stringent standards may also change the number of electric vehicles that are produced, and shift refueling to occur at a charging station or at a residence, rather than at the pump—changing per-vehicle lifetime expected refueling costs.

We estimate these savings by calculating the amount of refueling time avoided—including the time it takes to find, refuel, and pay—and multiplying it by DOT's value of time of travel savings estimate. For a full description of the methodology, refer to TSD Chapter 6.1.4.

(3) Additional Mobility

Any increase in travel demand provides benefits that reflect the value to drivers and other vehicle occupants of the added—or more desirable—social and economic opportunities that become accessible with additional travel. Under the alternatives in this analysis, the fuel cost per mile of driving would decrease as a consequence of the higher fuel economy levels they require, thus increasing the number of miles that buyers of new cars and light trucks would drive as a consequence of the well-documented fuel economy rebound effect.

The fact that drivers and their passengers elect to make more frequent or longer trips to gain access to these opportunities when the cost of driving declines demonstrates that the benefits they gain by doing so exceed the costs they incur. At a minimum, the benefits must equal the cost of the fuel consumed to travel the additional miles (or they would not have occurred). The cost of that energy is subsumed in the simulated fuel expenditures, so it is necessary to account for the benefits associated with those miles traveled here. But the benefits must also offset the economic value of their (and their passengers') travel time, other vehicle operating costs, and the economic cost of safety risks due to the increase in exposure that occurs with additional travel. The amount by which the benefits of this additional travel exceeds its economic costs measures the net benefits drivers and their passengers experience, usually referred to as increased consumer surplus.

TSD Chapter 6.1.5 explains the agency's methodology for calculating additional mobility. The benefit of additional mobility over and above its costs is measured by the change in consumers' surplus. This is calculated using the rule of one-half, and is equal to one-half of the change in fuel cost per mile times the increase in vehicle miles traveled due to the rebound effect.

In contrast to the societal cost-benefit analysis, calculation of average costs and benefits to consumers is done on a per-vehicle basis and is intended to describe how alternative standards affect the costs and benefits of owning vehicles from the consumers' perspective. The mobility costs and benefits per vehicle are affected by the assumption that total VMT before adding the rebound effect will be the same in the baseline and all alternative cases (See TSD Chapter 4.3.1). Because the standards affect vehicle sales and scrappage which changes the number of vehicles in the alternative cases, the

⁶⁵⁷ CBD et al., Appendix, Docket No. NHTSA–2021–0053–1572, at 31.

CAFE Model changes VMT per vehicle in the alternative cases to maintain a constant total non-rebounded VMT. When vehicle sales decrease in the alternative cases, VMT per vehicle increases. IPI and Drs. Jacobsen and Liao of the University of California at San Diego (UCSD) commented that changes in the size and age composition of the vehicle stock will change total VMT.⁶⁵⁸ IPI suggested VMT will change only “slightly,” while the UCSD commenters suggest reallocating only 50 percent of the difference in non-rebounded VMT between the baseline and alternative cases. We recognize that the assumption of constant non-rebounded VMT is an approximation, and we may consider the possibility of refining this method in the future.

When the size of the vehicle stock decreases in the alternative cases, VMT and fuel cost per vehicle increase. Because maintaining constant non-rebounded VMT assumes consumers are willing to pay the full cost of the reallocated vehicle miles, we offset the increase in fuel cost per vehicle by adding the product of the reallocated VMT and fuel cost per mile to the mobility value. This corrects an error in the NPRM per vehicle analysis, which included the fuel cost per vehicle of reallocated miles but not the mobility benefit per vehicle. Because we do not estimate other changes in cost per vehicle that could result from the reallocated miles (e.g., maintenance, depreciation, etc.) we do not estimate the portion of the transferred mobility benefits that would correspond to consumers’ willingness to pay for those costs. We do not estimate the consumers’ surplus associated with the reallocated miles because there is no change in total non-rebounded VMT and thus no change in consumers’ surplus per consumer.

2. External Costs and Benefits

(a) Costs

(1) Congestion and Noise

Increased vehicle use associated with the rebound effect also contributes to increased traffic congestion and highway noise. Although drivers obviously experience these impacts themselves, they do not fully value the costs these impacts impose on other road users and surrounding residents, just as they do not fully value the emissions impacts of their own driving. Congestion and noise costs are largely “external” to the vehicle owners whose decisions about how much, where, and when to drive more in response to

changes in fuel economy create these costs. Thus, unlike changes in the fuel costs drivers incur or the safety risks they assume when they decide to travel more, changes in congestion and noise costs are not offset by corresponding changes in the benefits drivers experience by making more frequent trips or traveling to more distant destinations.

While largely external to individual drivers, congestion costs are limited to road users as a whole; since road users include a significant fraction of the U.S. population, however, we treat changes in congestion costs as part of this rule’s broader economic impacts on society instead of as a private cost to those whose choices impose it. Costs resulting from road and highway noise are even more widely dispersed, because they are borne partly by surrounding residents, pedestrians, and other non-road users, and for this reason are also considered as a cost to the society as a whole.

To estimate the economic costs associated with changes in congestion and noise caused by differences in miles driven for the proposal, NHTSA updated FHWA’s 1997 Highway Cost Allocation Study’s estimates of marginal congestion costs to reflect changes in three factors that affect them: The time delays caused by the contribution of additional travel to congestion, increases in typical vehicle occupancy, and the hourly value of each occupant’s time. The agency assumed that delay per additional mile driven by cars and light trucks has increased in proportion to growth in annual vehicle travel per lane-mile of road and highway capacity in urban areas (where virtually all congestion occurs) since the date of the original FHWA study. Noise costs per additional mile driven were assumed to remain constant at their levels originally estimated by the FHWA study. Both congestion and noise costs were also updated to reflect changes in the economy-wide price level since their original publication and make them comparable to other economic values used in this analysis. The agency previously relied on this study in its 2010 (75 FR 25324, May 7, 2010), 2011 (76 FR 57106, Sept. 15, 2011), and 2012 (77 FR 62624, Oct. 15, 2012) final rules, and, like the estimates used in the proposal, a revised version for the 2020 final rule (85 FR 24174, April 30, 2020). Updating the individual underlying components for congestion costs in this analysis improves their currency and internal consistency with the rest of the analysis.

Some commenters objected to the agency’s use of increases in vehicle volumes per mile of roadway to

approximate the change in the incremental contribution to congestion and delays caused by additional car and light truck use. For example, CARB argued the revised values led the analysis to overestimate congestion costs. CARB claimed that the miscalculation arises from the scaling of vehicles per lane “because (1) it compares a figure for passenger cars to a figure for light-duty vehicles that includes sport-utility vehicles and vans, and (2) it is limited to interstate highways instead of all roads.”⁶⁵⁹ CARB further argued that the revised numbers do not account for changes in average speeds and improved road designs. California Attorney General et al. concurred with CARB’s comment and suggested using the 1997 estimates updated only for inflation.⁶⁶⁰

The agency disagrees with CARB’s argument for several reasons. First, the agency’s scaling of vehicle-miles per lane-mile uses figures that include all vehicle classes rather than those for light-duty vehicles alone. SUVs had only begun to enter the fleet in 1997; since then, they have increasingly substituted for passenger cars, and travel by both cars and SUVs is included in the figures that the agency compares for 1997 and more recent years.⁶⁶¹ Today’s SUVs are used interchangeably with passenger cars, and it is more than reasonable to assume that an additional SUV mile will produce the same marginal increase in congestion costs as an additional passenger car mile.

Second, the original 1997 FHWA estimate of congestion costs and the scaling that NHTSA used to update it both apply to all roads and highways, and this comparison is consistent with the approach NHTSA has taken across the last 5 rulemakings. Third, the comment did not explain the expected direction of changes in speed or provide support for the commenter’s claim that better road design has mitigated the effect of increased traffic volumes on travel speeds. Further, the commenter’s claims are difficult to reconcile: If we assume that better roads enable higher speeds despite increased traffic volumes, more frequent (and possibly more severe) crashes would result, and

⁶⁵⁹ CARB, Attachment 2, NHTSA–2021–0053–1521, at 13.

⁶⁶⁰ California Attorney General et al., Detailed Comments, NHTSA–2021–0053–1499, at 32.

⁶⁶¹ See, e.g., Tom Voelk, *Rise of S.U.V.s: Leaving Cars in Their Dust, With No Signs of Slowing*, N.Y. Times, May 21, 2020, available at <https://www.nytimes.com/2020/05/21/business/suv-sales-best-sellers.html>.

⁶⁵⁸ IPI, at 30; Jacobsen and Liao, at 2.

incidents are an important contributor to congestion.⁶⁶²

In response to these comments, the agency also analyzed changes in estimates of congestion delays reported by the Texas Transportation Institute (TTI), which are widely cited, use well-documented methods, and offer the only available measure of long-term trends in the economic costs of traffic congestion and delays.⁶⁶³ TTI's estimates of congestion delays are derived using well-established patterns of travel throughout the day and relationships between vehicle travel volumes and travel speeds for major roads and highways, and more recently on highly detailed measures of actual hourly travel speeds and vehicle volumes. The agency's calculations using TTI's detailed historical database show that from 1997 (the date of the original FHWA study) through 2017 (the end year used in the agency's update), person-hours of delay per vehicle-mile traveled increased 57 percent in the Nation's 100 largest urban areas and 52 percent in all (nearly 500) U.S. urban areas. More suggestively, *incremental* hours of delay per additional vehicle-mile traveled—a more direct measure of the impact of additional travel on congestion delays and one more comparable to that reported in the 1997 FHWA study—grew by 86 percent in the largest areas and by 131 percent in all U.S. urban areas over that same period. These calculations suggest that the 58 percent increase in person-hours of delay per additional vehicle-mile of travel reflected in the agency's updated estimate of incremental congestion costs is reasonable, so the agency has elected to retain its earlier estimate.

(2) Fuel Tax Revenue

As discussed previously in III.G.1.b)(1), a significant fraction of the fuel savings experienced by consumers includes avoided fuel taxes, which average nearly \$0.50 per gallon when Federal, state, and local excise and sales taxes levied on gasoline are included. Fuel taxes are treated as a transfer within the agency's analysis, which includes an offsetting loss in revenue to government agencies as a cost of raising CAFE standards, and thus do not affect net benefits from this rule; the agency reports this offsetting loss to illustrate

⁶⁶² See, e.g., https://safety.fhwa.dot.gov/speedmgt/ref_mats/fhwasa1304/Resources3/08%20-%20The%20Relation%20Between%20Speed%20and%20Crashes.pdf. The agency also notes that if the average speed has increased, then our safety costs would require adjustment as well.

⁶⁶³ For an overview and links to detailed reports and documentation, see <https://mobility.tamu.edu/umr/>.

the potential impact on government agencies that rely on fuel tax revenue to support the activities they fund.⁶⁶⁴

CFA erroneously commented that lost gasoline taxes were improperly included—for the first time—as a cost of the rule.⁶⁶⁵ Not only have both EPA and NHTSA previously reported changes in gasoline tax payments by consumers and in revenues to government agencies, but NHTSA's proposal explains in multiple places that gasoline taxes are considered a transfer—a cost to governments and an identical benefit to consumers that has already been accounted for in reported fuel savings—and has no impact on net benefits. In contrast, Walter Kreucher commented that billions in gasoline tax revenue would be lost if we finalized stricter standards.⁶⁶⁶ As indicated above, however, any reduction in tax revenue received by governments that levy taxes on fuel is exactly offset by lower fuel tax payments by consumers, so from an economy-wide standpoint reductions in gasoline tax revenues are simply a transfer of economic resources and has no effect on net benefits.

(b) Benefits

(1) Reduced Climate Damages

Extracting and transporting crude petroleum, refining it to produce transportation fuels, and distributing fuel all generate additional emissions of GHGs and criteria air pollutants beyond those from cars' and light trucks' use of fuel. By reducing the volume of petroleum-based fuel produced and consumed, adopting higher CAFE standards will thus mitigate global climate-related economic damages caused by accumulation of GHGs in the atmosphere, as well as the more immediate and localized health damages caused by exposure to criteria pollutants. Because they fall broadly on the U.S. population—and globally, in the case of climate damages—reducing them represents an external benefit from requiring higher fuel economy. The following subsections discuss the values used to estimate the economic consequences associated with climate damages and the discount rates applied to those benefits.

(a) Valuation of the Social Cost of Greenhouse Gases

In the proposal, NHTSA estimated the global social benefits from the

⁶⁶⁴ See OMB Circular A-4 for more information on transfer payments, and how they should be accounted for in regulatory analysis.

⁶⁶⁵ CFA, Docket No. NHTSA-2021-0053-1535, at 5.

⁶⁶⁶ Walt Kreucher, Docket No. NHTSA-2021-0053-0013, at 14.

reductions in emissions of CO₂, CH₄, and N₂O expected to result from this rule using the SC-GHG estimates presented in “Technical Support Document: Social Cost of Carbon, Methane, and Nitrous Oxide Interim Estimates under Executive Order 13990” (“February 2021 TSD”). These SC-GHG estimates are interim global values developed pursuant to E.O. 13990 for use in benefit-cost analysis.

The SC-GHG estimates used in our analysis were developed over many years, using a transparent process, peer-reviewed methodologies, and input from the public. Specifically, in 2009, an interagency working group (IWG) that included experts from the DOT and other executive branch agencies and offices was established to support agencies in using the most comprehensive available science and to promote consistency in the SC-GHG values used across agencies. The IWG published SCC estimates in 2010 that were developed using three peer-reviewed Integrated Assessment Models relating CO₂ and other GHG emissions to climate change and its potential economic impacts, and updated these estimates in 2013 using new versions of each IAM. In August 2016, the IWG published estimates of the social cost of methane (SC-CH₄) and nitrous oxide (SC-N₂O) using methodologies consistent with the underlying the SCC estimates. E.O. 13990 (issued on January 20, 2021) re-established an IWG, and directed it to publish interim SC-GHG values for CO₂, CH₄, and N₂O within thirty days. Furthermore, the E.O. tasked the IWG with updating the methodologies used in calculating these SC-GHG values. The E.O. instructed the IWG to utilize “the best available economics and science,” and incorporate principles of “climate risk, environmental justice, and intergenerational equity.”⁶⁶⁷ The E.O. also instructed the IWG to take into account the recommendations from the NAS committee convened on this topic published in 2017.⁶⁶⁸ The February 2021 TSD provides a complete discussion of the IWG's initial review conducted under E.O. 13990, and

⁶⁶⁷ Executive Order on Protecting Public Health and the Environment and Restoring Science to Tackle the Climate Crisis. (2021). Available at <https://www.whitehouse.gov/briefing-room/presidential-actions/2021/01/20/executive-order-protecting-public-health-and-environment-and-restoring-science-to-tackle-climate-crisis/>.

⁶⁶⁸ National Academy of Sciences (NAS). (2017). Valuing Climate Damage: Updating Estimation of the Social Cost of Carbon Dioxide. Available at <https://www.nap.edu/catalog/24651/valuing-climate-damages-updating-estimation-of-the-social-cost-of>.

NHTSA incorporates that discussion by reference into this preamble.

NHTSA is using the IWG's interim values, published in February 2021 in a technical support document, for this CAFE analysis.⁶⁶⁹ As a member of the IWG, DOT has thoroughly reviewed the inputs and methodological choices for these estimates, and DOT affirms that, in its expert judgment, the Interim Estimates reflect the best available science and economics and are the most appropriate values to use in the analysis of this rule. This use of the IWG estimates is the same approach as that taken in DOT regulatory analyses between 2009 and 2016, and is consistent with the proposal.

NHTSA indicated in the NPRM that if the Interagency Working Group issued revised estimates of climate damages in time for NHTSA to evaluate whether to incorporate them into this final rule, NHTSA would consider using them. The IWG has not issued revised estimates.

The following section provides further discussion of the discount rates that NHTSA uses in its regulatory analysis. For a full discussion of the agency's quantification of GHGs, see TSD Chapter 6.2.1 and the FRIA.

(b) Discount Rates for Climate Related Benefits

A standard function of regulatory analysis is to evaluate tradeoffs between impacts that occur at different points in time. Many Federal regulations involve costly upfront investments that generate future benefits in the form of reductions in health, safety, or environmental damages. To evaluate these tradeoffs, the analysis must account for the social rate of time preference—the broadly observed social preference for benefits that occur sooner versus those that occur further in the future.⁶⁷⁰ This is accomplished by discounting impacts that occur further in the future more than impacts that occur sooner.

OMB Circular A–4 affirmed the appropriateness of accounting for the social rate of time preference in regulatory analyses and recommended discount rates of 3 and 7 percent for

doing so. The recommended 3 percent discount rate was chosen to represent the “consumption rate of interest” approach, which discounts future costs and benefits to their present values using the rate at which consumers appear to make tradeoffs between current consumption and equal consumption opportunities deferred to the future. OMB Circular A–4 reports an inflation-adjusted or “real” rate of return on 10-year Treasury notes of 3.1 percent between 1973 and its 2003 publication date and interprets this as approximating the rate at which society is indifferent between consumption today and in the future.

The 7 percent rate reflects the opportunity cost of capital approach to discounting, where the discount rate approximates the forgone return on private investment if the regulation were to divert resources from capital formation.⁶⁷¹ OMB Circular A–4 cites pre-tax rates of return on capital as part of its selection of the 7 percent rate.⁶⁷² The IWG rejected the use of the opportunity cost of capital approach to discounting reductions in climate-related damages, concluding that the “consumption rate of interest is the correct discounting concept to use when future damages from elevated temperatures are estimated in consumption-equivalent units as is done in the IAMs used to estimate the SC–GHG (National Academies 2017).”⁶⁷³ In fact, Circular A–4 indicates that discounting at the consumption rate of interest is the “analytically preferred method” when effects are presented in consumption-equivalent units.⁶⁷⁴ DOT concurs that in light of Circular A–4's

guidance on discount rates spanning displacement of investments and/or consumption, and given the considerations that climate damages are modeled in consumption equivalent units and intergenerational equity, the use of consumption based discount rates is superior for estimating SC–GHG.

As the IWG states, “GHG emissions are stock pollutants, where damages are associated with what has accumulated in the atmosphere over time, and they are long lived such that subsequent damages resulting from emissions today occur over many decades or centuries depending on the specific greenhouse gas under consideration.”⁶⁷⁵ OMB Circular A–4 states that impacts occurring over such intergenerational time horizons require special treatment:

Special ethical considerations arise when comparing benefits and costs across generations. Although most people demonstrate time preference in their own consumption behavior, it may not be appropriate for society to demonstrate a similar preference when deciding between the well-being of current and future generations. Future citizens who are affected by such choices cannot take part in making them, and today's society must act with some consideration of their interest.⁶⁷⁶

Furthermore, NHTSA notes that in 2015, OMB—along with the rest of the IWG—articulated that “Circular A–4 is a living document, which may be updated as appropriate to reflect new developments and unforeseen issues,” and that “the use of 7 percent is not considered appropriate for intergenerational discounting. There is wide support for this view in the academic literature, and it is recognized in Circular A–4 itself.”⁶⁷⁷ Following this statement from OMB, and in light of the need to weigh welfare to current and future generations, it would be inappropriate to apply an opportunity cost of capital rate to estimate SC–GHG.

In addition to the ethical considerations, Circular A–4 also identifies uncertainty in long-run interest rates as another reason why it is appropriate to use lower rates to discount intergenerational impacts, since recognizing such uncertainty causes the appropriate discount rate to decline gradually over progressively longer time horizons. Circular A–4 also acknowledges the difficulty in estimating appropriate discount rates for

⁶⁶⁹ Interagency Working Group on Social Cost of Greenhouse Gases, United States Government. (2021). *Technical Support Document: Social Cost of Carbon, Methane, and Nitrous Oxide Interim Estimates under Executive Order 13990*, available at https://www.whitehouse.gov/wp-content/uploads/2021/02/TechnicalSupportDocument_SocialCostofCarbonMethaneNitrousOxide.pdf.

⁶⁷⁰ This preference is observed in many market transactions, including by savers that expect a return on their investments in stocks, bonds, and other equities; firms that expect positive rates of return on major capital investments; and banks that demand positive interest rates in lending markets.

⁶⁷¹ As the IWG explained, use of the 7 percent opportunity cost of capital approach in fact “at best creat[es] a lower bound on the estimate of net benefits that would only be met in an extreme case where regulatory costs fully displace investment.” Interagency Working Group on Social Cost of Greenhouse Gases, United States Government, *Technical Support Document: Social Cost of Carbon, Methane, and Nitrous Oxide, Interim Estimates under Executive Order 13990*, February 2021. NHTSA agrees and observes that this rule does not represent such an “extreme case.” NHTSA's analysis assumes that most of the rule's costs and benefits, including technology costs passed through to consumers, will affect consumption choices. The focus on consumption rates is therefore especially appropriate.

⁶⁷² OMB Circular A–4.
⁶⁷³ Interagency Working Group on Social Cost of Greenhouse Gases, United States Government, *Technical Support Document: Social Cost of Carbon, Methane, and Nitrous Oxide, Interim Estimates under Executive Order 13990*, February 2021.

⁶⁷⁴ OMB, Circular A–4. See also Declaration of Dominic J. Mancini. Submitted in Support of Defendants' Motion for a Stay Pending Appeal, *Louisiana v. Biden*, Case No. 2:21–cv–01074–JDC–KK (W.D. La., filed Feb. 19, 2022) (confirming the appropriateness of this approach to discounting).

⁶⁷⁵ Ibid.

⁶⁷⁶ OMB Circular A–4.

⁶⁷⁷ Interagency Working Group on the Social Cost of Carbon, United States Government, *Response to Comments: Social Cost of Carbon for Regulatory Impact Analysis under Executive Order 12866*, July 2015. Note that OMB, as a co-chair of the IWG, published the request for comments.

“intergenerational” time horizons, noting that “[p]rivate market rates provide a reliable reference for determining how society values time within a generation, but for extremely long time periods no comparable private rates exist.”⁶⁷⁸ The social costs of distant future climate damages—and by implication, the value of reducing them by lowering emissions of GHGs—are highly sensitive to the discount rate, and the present value of reducing future climate damages grows at an increasing rate as the discount rate used in the analysis declines. This “non-linearity” means that even if uncertainty about the exact value of the long-run interest rate is equally distributed between values above and below the 3 percent consumption rate of interest, the probability-weighted (or “expected”) present value of a unit reduction in climate damages will be higher than the value calculated using a 3 percent discount rate. The effect of such uncertainty about the correct discount rate can be accounted for by using a lower “certainty-equivalent” rate to discount distant future damages, defined as the rate that produces the expected present value of a reduction in future damages implied by the distribution of possible discount rates around what is believed to be the most likely single value.

The IWG identifies “a plausible range of certainty-equivalent constant consumption discount rates: 2.5, 3, and 5 percent per year,” each intended to reflect the effect of uncertainty surrounding alternative estimates of the correct discount rate. The IWG’s justification for its selection of these rates is summarized in this excerpt from its 2021 guidance:

The 3 percent value was included as consistent with estimates provided in OMB’s Circular A-4 (OMB 2003) guidance for the consumption rate of interest. . . . The upper value of 5 percent was included to represent the possibility that climate-related damages are positively correlated with market returns, which would imply a certainty equivalent value higher than the consumption rate of interest. The low value, 2.5 percent, was included to incorporate the concern that interest rates are highly uncertain over time. It represents the average certainty-equivalent rate using the mean-reverting and random walk approaches from Newell and Pizer (2003) starting at a discount rate of 3 percent. Using this approach, the certainty equivalent is about 2.2 percent using the random walk model and 2.8 percent using the mean reverting approach. Without giving preference to a particular model, the average of the two rates is 2.5 percent. Additionally, a rate below the consumption rate of interest would also be justified if the return to

investments in climate mitigation are negatively correlated with the overall market rate of return. Use of this lower value was also deemed responsive to certain judgments based on the prescriptive or normative approach for selecting a discount rate and to related ethical objections that have been raised about rates of 3 percent or higher.

Because the certainty-equivalent discount rate will lie progressively farther below the best estimate of the current rate as the time horizon when future impacts occur is extended, the IWG’s recent guidance also suggests that it may be appropriate to use a discount rate that declines over time to account for interest rate uncertainty, as has been recommended by NAS and EPA’s Science Advisory Board.⁶⁷⁹ The IWG noted that it will consider these recommendations and the relevant academic literature on declining rates in developing its final guidance on the social cost of greenhouse gases.

The IWG 2021 interim guidance also presented new evidence on the consumption-based discount rate suggesting that a rate lower than 3 percent may be appropriate. For example, the IWG replicated OMB Circular A-4’s original 2003 methodology for estimating the consumption rate using the average return on 10-year Treasury notes over the last 30 years and found a discount rate close to 2 percent. They also presented rates over a longer time horizon, finding an average rate of 2.3 percent from 1962 to the present. Finally, they summarized results from surveys of experts on the topic and found a “surprising degree of consensus” for using a 2 percent consumption rate of interest to discount future climate-related impacts.⁶⁸⁰

NHTSA notes that the primary analysis of the NPRM estimated benefits from reducing emissions of CO₂ and other GHGs using per-ton values of reducing their emissions that incorporated a 2.5 percent discount rate for distant future climate damages, while it discounted costs and non-climate related benefits using a 3 percent rate. NHTSA also presented cost and benefits estimates in the primary analysis that reflected unit values of reducing GHG emissions constructed using a 3 percent discount rate for reductions in climate-related damages, while discounting costs and non-climate related benefits at 7 percent. NHTSA

believed at the time this approach represented an appropriate treatment of the intergenerational issues presented by emissions that result in climate-related damages over a very-long time horizon, and was within scope of the IWG’s *Technical Support Document: Social Cost of Carbon, Methane, and Nitrous Oxide* that recommends discounting future climate damages at rates of 2.5, 3, and 5 percent.⁶⁸¹

In addition, NHTSA emphasized the importance and value of considering the benefits calculated using all four SC-GHG estimates for each of three greenhouse gases. NHTSA included the social costs of CO₂, CH₄, and N₂O calculated using the four different estimates recommended in the February 2021 TSD (model average at 2.5 percent, 3 percent, and 5 percent discount rates; 95th percentile at 3 percent discount rate) in the FRIA.

The IWG TSD does not address the question of how agencies should combine its estimates of benefits from reducing GHG emissions that reflect these alternative discount rates with the discount rates for nearer-term benefits and costs prescribed in OMB Circular A-4. However, the February 2021 TSD identifies 2.5 percent as the “average certainty-equivalent rate using the mean-reverting and random walk approaches from Newell and Pizer (2003) starting at a discount rate of 3 percent.”⁶⁸² As such, NHTSA believed using a 2.5 percent discount rate for climate-related damages was consistent with the IWG TSD.

As indicated above, NHTSA’s PRIA presented cost and benefit estimates using a 2.5 percent discount rate for reductions in climate-related damages and 3 percent for non-climate related impacts. NHTSA also presented cost and benefits estimates using a 3 percent discount rate for reductions in climate-related damages alongside estimates of non-climate related impacts discounted at 7 percent. This latter pairing of a 3 percent rate for discounting benefits from reducing climate-related damages with a 7 percent discount rate for non-climate related impacts is consistent with NHTSA’s past practice.⁶⁸³ However, NHTSA’s pairing in the PRIA of 2.5 percent for climate-related damage reductions with 3 percent for non-climate related impacts was novel.

⁶⁷⁹ Interagency Working Group on Social Cost of Greenhouse Gases, United States Government, *Technical Support Document: Social Cost of Carbon, Methane, and Nitrous Oxide, Interim Estimates under Executive Order 13990*, February 2021.

⁶⁸⁰ *Ibid.*

⁶⁸¹ Interagency Working Group on Social Cost of Greenhouse Gases, United States Government, *Technical Support Document: Social Cost of Carbon, Methane, and Nitrous Oxide, Interim Estimates under Executive Order 13990*, February 2021.

⁶⁸² *Ibid.*

⁶⁸³ See, e.g., the 2012 and 2020 final CAFE rules.

⁶⁷⁸ *Ibid.*

In this final rule, NHTSA has not selected a primary discount rate for the social cost of greenhouse gases and instead presents non-GHG related impacts of the final rule discounted at 3 and 7 percent alongside estimates of the social cost of greenhouse gases reflecting each of the three discount rates presented by the IWG. This approach was selected because, as NHTSA pointed out in the NPRM, the IWG does not specify which of the discount rates it recommends should be considered the agency's primary estimate. The agency's analysis showing our primary non-GHG impacts at 3 and 7 percent alongside climate-related benefits discounted at each rate recommended by the IWG may be found in FRIA Chapter 6.5.6. For the sake of simplicity, most tables throughout this analysis pair both the 3 percent and the 7 percent discount rates with the social costs of greenhouse gases discounted at a 3 percent rate. To calculate the present value of climate benefits, we also use the same discount rate as the rate used to discount the value of damages from future GHG emissions, for internal consistency.⁶⁸⁴ We believe that this approach provides policymakers with a range of costs and benefits associated with the rule using a reasonable range of discounting approaches and associated climate benefits, as well as the 95th percentile value that illustrates the potential for climate change to cause damages that are much higher than the "best guess" damage estimates. This approach is also consistent with the options outlined by NAS's 2017 recommendations on how SC-GHG estimates can "be combined in RIAs with other cost and benefits estimates that may use different discount rates." NAS reviewed "several options," including "presenting all discount rate combinations of other costs and benefits with [SC-GHG] estimates."

(c) Comments and Responses About the Agency's Choice of Social Cost of Carbon Estimates and Discount Rates

California Attorney General et al. commented that the 3 percent discount rate was too high, referencing the discussion in the IWG's interim guidance showing rates on 10-year Treasury notes hovering around 2 percent over the last 30 years. Our Children's Trust commented that the use of any discount rate on reductions in future climate damages is

unconstitutional because it treats them "as less valuable or not equal under the eyes of the law when it comes to life, liberty, personal security and a climate system that sustains human life, among other unalienable rights." AFPM argued that we should discount the benefit of reduced climate-related costs at the same rate as is used to discount other costs and benefits.⁶⁸⁵

As noted above, NHTSA presented and considered a range of discount rates, including 2.5 percent and 5 percent. The above discussion also explained why it is important to adjust the discounting approach in the context of intergenerational effects and uncertainty about long-run interest rates. NHTSA disagrees, however, with the argument that the use of discounting where there are intergenerational effects is a violation of the Constitution. The impacts on future generations are reflected in the estimates used in this analysis.

IPI et al. commented in general support of the agency's approach to estimating SC-GHG. They argued that the agency should acknowledge that the IWG's estimates are appropriate but may underestimate the effects of climate change,⁶⁸⁶ and that the transparent and rigorous methodology employed by IWG was based on the available science which adds credibility to their estimates.⁶⁸⁷ Their comment continued by arguing that the agency should continue to use a global estimate of SCC-GHG because doing so is supported by science and a domestic estimate would understate U.S. extraterritorial interests, damages such as security threats and transboundary damages that spillover into the U.S., and harm U.S. citizens and assets that are extraterritorial.⁶⁸⁸ Finally, IPI et al. commented that the agency's approach to discounting climate-related benefits was appropriate, but argued that the agency should consider aligning with EPA's methodology of reporting climate benefits at 3 percent for the majority of the tables and include a sensitivity analysis at a 2 percent discount rate.⁶⁸⁹ Many of the points raised by IPI et al. are aligned with the agency's approach in both the proposal and final rule.

Competitive Enterprise Institute recommended against the agency's use of the Interagency Working Group's Interim Estimates of the social cost of carbon. CEI argued that the degree of

global warming mitigation projected by NHTSA is too small to generate climate benefits valued at the scale valued by NHTSA using the IWG Interim Estimates. CEI also argued that the 7 percent discount rate is the appropriate discount rate for climate damage reduction benefits and that using a lower rate would justify mitigation projects with a lower rate of return than could be found in private markets. CEI's rationale was that investing in higher rate of return projects today would pass along more wealth to future generations, making them better able to overcome the adversity posed by potential climate change. They argued that the SC-GHG is highly sensitive to the time horizon of the analysis and that the SC-GHG drops significantly if the time horizon for estimating climate damages is shortened from 300 years to 150 years, and suggested that the outer years of the 300-year time-horizon were speculative. CEI also argued that the IWG uses an outdated equilibrium climate sensitivity distribution and that more recent studies present distributions with lower modal and central values. They argued that CO₂ emissions have important benefits to agriculture and plant growth through carbon fertilization, which increases internal plant water use efficiency. Finally, they argued that the IWG's assumptions regarding human adaptation mitigating the costs of climate change and projected baseline carbon emissions were unduly pessimistic.

Estimating the social costs of future climate damages caused by emissions of greenhouse gases, or SC-GHG, requires analysts to make a number of projections that necessarily involve uncertainty—for example, about the likely future pattern of global emissions of GHGs—and to model multifaceted scientific phenomena, including the effect of cumulative emissions and atmospheric concentrations of GHGs on climate measures including global surface temperatures and precipitation patterns. Each of these entail critical judgements about complex scientific and modeling questions. Doing so requires specialized technical expertise, accumulated experience, and expert judgment, and highly trained, experienced, and informed analysts can reasonably differ in their judgements.

CEI's comments raise questions about the IWG's selection of the specific assumptions and parameter values it used to produce the estimates of the social costs of various GHGs that NHTSA relies on in this regulatory analysis, and contends that using alternative assumptions and values would reduce the IWG's recommended

⁶⁸⁴ This approach follows the same approach that the IWG's February 2021 TSD recommended "to ensure internal consistency—i.e., future damages from climate change using the SC-GHG at 2.5 percent should be discounted to the base year of the analysis using the same 2.5 percent rate."

⁶⁸⁵ AFPM, NHTSA-2021-0053-1530, at 19-21.

⁶⁸⁶ IPI et al., Docket No. NHTSA-2021-0053-1547, at 4-7.

⁶⁸⁷ *Id.* at 31-41.

⁶⁸⁸ *Id.* at 7-14.

⁶⁸⁹ *Id.* at 14-31.

values significantly. However, the agency notes that the IWG's membership includes experts in climate science, estimation of climate-related damages, and economic valuation of those impacts, and that these members applied their collective expertise to review and evaluate available empirical evidence and alternative projections of important measures affecting the magnitude and cost of such damages. The agency also notes that the IWG members employed a collaborative, consensus-based process to arrive at their collective judgements about the most reliable assumptions and parameter values. In addition, the IWG uses its consensus assumptions and estimates in conjunction with three different widely recognized, peer-reviewed models of climate economic impacts, and its recommended values represent a synthesis of the costs each one estimates on the basis of that common set of inputs. Finally, DOT uses its own judgment in applying the estimates in this analysis.

Thus, the agency believes that the SC-GHG estimates developed by the IWG have two important advantages over other available estimates: First, they are the product of consensus estimates of the critical inputs necessary to estimate damage costs for GHGs; and second, they synthesize the results of multiple estimation methods represented in different widely regarded models. As a consequence, NHTSA views the IWG's recommended values as the most reliable among those that were available for it to use in its analysis. While the agency acknowledges that—as CEI notes—selecting certain input assumptions and parameter estimates different from those the IWG chose could reduce those values, it also agrees with the IWG that equally and perhaps more plausible assumptions and parameter values would have resulted in estimated SC-GHG values that were far higher than those the group ultimately recommended. Furthermore, due to omitted damage categories, NHTSA concurs with the IWG that its estimates are likely conservative underestimates. Unlike the IWG's work, we feel that CEI, Children's Trust, and the other commenters did not address the inherent uncertainty in estimating the SC-GHG. Specifically, we note that any alternative model that attempts to project the costs of GHGs over the coming decades—and centuries—will be subject to the same uncertainty and criticisms raised by commenters. Commenters essentially ask NHTSA to replace this working group's expertise in favor of specific alternative

perspectives presented outside of the full context of the IWG's significantly technical and multifaceted assessments. Furthermore, these alternative estimates are reliant on the commenters' specific set of assumptions of the future being correct.⁶⁹⁰ The IWG's analysis considered the possibility that its assumptions were either too conservative or extreme, and based its guidance on a robust review of potential outcomes.

CEI commented that the probability distribution function the IWG uses to simulate the equilibrium climate sensitivity is outdated and that more recent empirical work suggests the distribution should have a lower central tendency. However, CEI's comment overlooked the seminal work published in 2021 by the Intergovernmental Panel on Climate Change (IPCC)—an organization of expert scientists with 195 members chartered by the United Nation and the World Meteorological Organization that reviews the scientific work of thousands of contributors all over the world and provides a comprehensive summary “about what is known about the drivers of climate change, its impacts and future risks, and how adaptation and mitigation can reduce those risks.”⁶⁹¹ This work was subjected to a transparent review by experts and governments all around the world to “ensure an objective and complete assessment and to reflect a diverse range of views and expertise.”⁶⁹² The IPCC's most recent report states that “[i]mproved knowledge of climate processes, paleoclimate evidence and the response of the climate system to increasing radiative forcing gives a best estimate of equilibrium climate sensitivity of 3 degrees Celsius.”⁶⁹³ This is the same value the IWG's probability distribution function uses as the median estimate of equilibrium climate sensitivity. While the IWG may choose to revisit the

⁶⁹⁰ For example, CEI argued that the IWG estimates “err[ed] on the side of alarm and regulatory ambition.” However, if CEI is being overly optimistic about how mankind can deal with a changing climate or the possibility that carbon may have some benefits on agriculture, IWG's estimate could be an accurate—or even underestimate—of the SC-GHG.

⁶⁹¹ Intergovernmental Panel on Climate Change website, <https://www.ipcc.ch/about/>.

⁶⁹² *Ibid.*

⁶⁹³ IPCC, 2021: Summary for Policymakers. In: Climate Change 2021: The Physical Science Basis. Contribution of Working Group I to the Sixth Assessment Report of the Intergovernmental Panel on Climate Change [Masson-Delmotte, V., P. Zhai, A. Pirani, S.L. Connors, C. Péan, S. Berger, N. Caud, Y. Chen, L. Goldfarb, M. I. Gomis, M. Huang, K. Leitzell, E. Lonnoy, J.B.R. Matthews, T.K. Maycock, T. Waterfield, O. Yelekçi, R. Yu and B. Zhou (eds.)]. Cambridge University Press. In Press. SPM-13.

distribution it uses for simulating the equilibrium climate sensitivity in a future forthcoming update, it is clear that the distribution used for the interim values is reasonable and scientifically defensible.

CEI also commented that we should use an SC-GHG in our main analysis that only reflects damages to the United States. As an initial matter, such an estimate would undermine the many rationales for a global estimate articulated by the IWG, which emphasizes the value of a global analysis to sufficiently and comprehensively estimate climate damages. NHTSA believes that continued reliance on the IWG's recommendations in this respect remains appropriate for all of the reasons outlined above, which underscore the reasonableness of the IWG's consensus-based approach.

However, even beyond the recommendations of the IWG, NHTSA agrees with the IWG that climate change is a global problem and that the global SC-GHG values are appropriate for this analysis. Emitting greenhouse gases creates a global externality, in that GHG emitted in one country mix uniformly with other gases in the atmosphere and the consequences of the resulting increased concentration of GHG are felt all over the world.

The effects of climate change are global and affect the United States through many different pathways. These include through destabilization that affects our national security, economic impacts due to interlinked global economies, in danger and risk to U.S. military assets abroad, harm to soldiers stationed outside the United States, increased migration to the United States due to climate events like drought, the provision of disaster aid in response to disasters caused by climate change, interruptions to supply chains from extreme weather events, and in many other ways. Given methodological challenges, it has not yet been possible to derive a robust social cost estimate that isolates impacts to the United States and its inhabitants and, in many respects, such an estimate represents an artificial distinction that fails to account for the comingling of interests throughout the world. The models used both for the Interim Estimates and for the 2020 rule's SC-GHG value do not organize all of the relevant economic and welfare impacts by country, and as such, it is not possible to develop robust estimates of U.S.-specific damages. As the Government Accountability Office concluded in a June 2020 report examining the SC-GHG values used in the 2020 rule, the models “were not

premised or calibrated to provide estimates of the social cost of carbon based on domestic damages.”⁶⁹⁴ Further, the report noted that NAS found that country-specific social costs of carbon estimates were “limited by existing methodologies, which focus primarily on global estimates and do not model all relevant interactions among regions.”⁶⁹⁵ It is also important to note that the 2020 rule’s SC–GHG values were never peer reviewed, and when their use in a specific regulatory action was challenged, a Federal court determined that use of a U.S.-only value had been “soundly rejected by economists as improper and unsupported by science,” and that the values themselves omitted key U.S.-specific damages including to supply chains, U.S. assets and companies, and geopolitical security. *California v. Bernhardt*, 472 F.Supp.3d 573, 613–14 (N.D. Cal. 2020).

Furthermore, the United States cannot address the domestic consequences of climate change for the United States by itself. Instead, we need other nations to take action to reduce their own domestic emissions and to consider the benefits of their emission reductions to the United States. In order to ensure other nations take similar actions to reduce GHG emissions, the United States is actively involved in developing and implementing international commitments to secure reductions in GHG emissions. If the United States fails to consider the benefits (and harms) of its actions to other countries, our bargaining position is significantly weakened. It is hard to argue that a large emitter like China, for example, should consider the global consequences of its actions—including to the United States—if the United States fails to do so. As a result, the United States may fail to secure sufficient emission reduction commitments from its counterparts to reduce adverse consequences from climate change that will affect the United States if it were to use U.S.-specific values for the SC–GHG. A wide range of scientific and economic experts have emphasized the issue of reciprocity as support for considering global damages of GHG emissions. Using a global estimate of damages in U.S. analyses of regulatory actions allows the United States to continue to actively encourage other nations, including emerging major economies, to take significant steps to

reduce emissions. The only way to achieve an efficient allocation of resources for emissions reduction on a global basis—and so benefit the United States and its citizens—is for all countries to base their policies on global estimates of damages.

Further, in practice, data and modeling limitations naturally restrain the ability of estimates of SC–GHG to include all of the important physical, ecological, and economic impacts of climate change, such that the estimates are a partial accounting of climate change impacts and will therefore tend to be underestimates of the marginal benefits of abatement. As an empirical matter, the development of a U.S.-specific SC–GHG is greatly complicated by the relatively few region- or country-specific estimates of the SC–GHG in the literature.

Importantly, due to methodological constraints, NHTSA is not aware of a robust analysis that isolates damages to the United States. Due to these constraints, the SC–GHG value used in the 2020 final rule is an underestimate of damages to the United States, and as such is inappropriately low for purposes of informing the current analysis. However, NHTSA explored an analysis incorporating a U.S.-specific social cost of carbon as promoted by commenters such as CEI in order to comply with a preliminary injunction issued by the United States District Court for the Western District of Louisiana on February 11, 2022, that enjoined NHTSA from, among other activities, “[a]dopting, employing, treating as binding, or relying upon any [SC–GHG] estimates based on global effects,” as well as from “adopting, employing, treating as binding, or relying upon the work product of the [IWG].”⁶⁹⁶ When NHTSA considered that analysis, the agency determined that the selected standards continue to remain maximum feasible.

Even with the underestimate of climate benefits, the analysis still contained numerous quantitative indicia that the new standards remained appropriate. For instance, fuel savings for the preferred alternative still exceeded the price increase due to the rule by \$290.⁶⁹⁷ Likewise, a calendar year accounting using a 3 percent discount rate still revealed a net benefit for the preferred alternative of \$28.1

billion. Moreover, these figures—like any cost-benefit analysis results in a CAFE rulemaking—offered only one informative data point in addition to the host of considerations that NHTSA must balance by statute when determining maximum feasible standards. Even taking the severely reduced climate benefit estimates into account, the overall balance of other significant qualitative and quantitative considerations and factors support the selection of the preferred alternative, as described at length throughout this final rule. Accordingly, even the limited perspective of impacts urged by commenters such as CEI would not alter the standards necessitated in this rulemaking.

NHTSA believes that the three issues raised by CEI and specifically addressed in this section on the IWG’s interim values—regarding the use of opportunity cost of capital discounting, the use of global values for the social costs of greenhouse gases, and the probability distribution function of equilibrium climate sensitivity—are representative of their comments overall in that they choose to highlight areas of uncertainty and dynamics that would tend to reduce the social cost of carbon. In each case, CEI has chosen to ignore sources of uncertainty and dynamics that may increase the social cost of carbon and asserts scientific authority only where the cited papers or dynamics would tend to reduce it.

Contrary to the position put forward by Children’s Trust that it is unlawful to discount the estimated costs of SC–GHG, we also believe that discounting the SC–GHG estimate to develop a present value of the benefits of reducing GHG emissions is consistent with the law, and that the discounting approach used by the IWG is reasonable. Unsurprisingly, when the cost-benefit analysis is the predominant basis for an agency’s decision, courts have previously reviewed and affirmed rules that discount climate-related costs.⁶⁹⁸ Courts have likewise advised agencies to approach cost-benefit analyses with impartiality, to ensure that important factors are captured in the analysis, including climate benefits,⁶⁹⁹ and to ensure that the decision rests “on a consideration of the relevant factors.”⁷⁰⁰ NHTSA has followed these principles here.

For these reasons, NHTSA believes that the Interim Estimates employed in

⁶⁹⁴ GAO, Social Cost of Carbon: Identifying a Federal Entity to Address the National Academies’ Recommendations Could Strengthen Regulatory Analysis, GAO–20–254 (June 2020) at 29.

⁶⁹⁵ Id. at 26.

⁶⁹⁶ *Louisiana v. Biden*, Order, No. 2:21–CV–01074, ECF No. 99 (W.D. La. Feb. 11, 2022). That injunction was subsequently stayed. *Louisiana v. Biden*, Order, No. 22–30087, Doc. No. 00516242341 (5th Cir. Mar. 16, 2022).

⁶⁹⁷ This final rule is estimated to increase the price of model year 2029 vehicles by \$1,087 and save consumer \$1,387.

⁶⁹⁸ See, e.g., *E.P.A. v. EME Homer City Generation, L.P.*, 572 U.S. 489 (2015).

⁶⁹⁹ *CBD v. NHTSA*, 538 F.3d 1172, 1197 (9th Cir. 2008).

⁷⁰⁰ *State Farm*, 463 U.S. 29, 43 (1983) (internal quotation marks omitted).

this analysis and the results they produce are the most reliable estimates of what are inherently uncertain values it could have selected, and that the range of values used to examine the sensitivity of its results adequately incorporate the range of uncertainty surrounding the values used in its central analysis.

(2) Reduced Health Damages

The CAFE Model estimates monetized health effects associated with emissions from three criteria pollutants: NO_x, SO_x, and PM_{2.5}. As discussed in Section III.F above, although other criteria pollutants are currently regulated, we only calculate impacts from these three pollutants since they are known to be emitted regularly from mobile sources, have the most adverse effects to human health, and are based on EPA papers that estimate the benefits per ton of reducing these pollutants.

CBD et al. stated that NHTSA improved the monetization of PM_{2.5} attributable to fuel economy standards (discussed further below); however, the commenters also argued that NHTSA should monetize benefits from reductions in ozone and air toxics.⁷⁰¹

As we discussed in the proposal, other pollutants, especially those that are precursors to ozone, are difficult to model due to the complexity of their formation in the atmosphere, and EPA does not calculate benefit-per-ton estimates for these. We will continue to explore this concept for future analyses. Chapter 5.4 of the TSD includes a section on uncertainty related to monetizing health impacts. The Final SEIS also includes a section describing the health effects of ozone and air toxics (see Section 4.1.1.2).

The CAFE Model computes the monetized impacts associated with health damages from each pollutant by multiplying monetized health impact per ton values by the total tons of these pollutants, which are emitted from both upstream and tailpipe sources. Chapter 5 of the TSD accompanying this final rule includes a detailed description of the emission factors that inform the CAFE Model's calculation of the total tons of each pollutant associated with upstream and tailpipe emissions.

These monetized health impacts per ton values are closely related to the health incidence per ton values described above in Section III.F and in detail in Chapter 5.4 of the TSD. We use the same EPA sources that provide health incidence values to determine which monetized health impacts per ton

values to use as inputs in the CAFE Model. Like the estimates associated with health incidences per ton of criteria pollutant emissions, we use multiple EPA papers and conversations with EPA staff to appropriately account for monetized damages for each pollutant associated with the source sectors included in the CAFE Model, based on which papers contain the most up-to-date data corresponding to the relevant source sectors.⁷⁰² The various emission source sectors included in the EPA papers do not always correspond exactly to the emission source categories used in the CAFE Model.⁷⁰³ In those cases, we map multiple EPA sectors to a single CAFE source category and compute a weighted average of the health impact per ton values.

CBD et al. stated that the estimates of the benefits of PM_{2.5} reductions were improved by the addition of the Wolfe et al. paper to the sources used by NHTSA.⁷⁰⁴ We agree, and continue to use these sources in the final rulemaking analysis as they allow us to map sectors to categories that are more expansive and specific than the original 2018 source.

EPA uses the value of a statistical life (VSL) to estimate premature mortality impacts, and a combination of willingness to pay estimates and costs of treating the health impact for estimating the morbidity impacts.⁷⁰⁵ EPA's 2018 TSD, "Estimating the Benefit per Ton of Reducing PM_{2.5} Precursors from 17 Sectors,"⁷⁰⁶ (referred to here as the 2018 EPA source apportionment TSD) contains a more detailed account of how health incidences are monetized. It is important to note that the EPA sources cited frequently refer to these monetized health impacts per ton as "benefits per

ton," since they describe these estimates in terms of emissions avoided. In the CAFE Model input structure, these are generally referred to as monetized health impacts or damage costs associated with pollutants emitted, not avoided, unless the context states otherwise.

The Competitive Enterprise Institute questioned the use of the specific EPA studies that inform the BPT values that NHTSA uses, namely the Six Cities Study.⁷⁰⁷ We report only one BPT estimate in this final rule, based on the Krewski et al. study, to be consistent with EPA in their final GHG rule. We consulted with EPA staff at the Office of Air Quality Planning and Standards (OAQPS) on the most appropriate benefit per ton values to use for the various upstream and tailpipe emission categories. EPA bases its benefits analyses on peer-reviewed studies of air quality and health effects and peer-reviewed studies of the monetary values of public health and welfare improvements. Very recently, EPA updated its approach to estimating the benefits of changes in PM_{2.5} and ozone.^{708 709} These updates were based on information drawn from the recent 2019 PM_{2.5} and 2020 Ozone Integrated Science Assessments (ISAs), which were reviewed by the Clean Air Science Advisory Committee (CASAC) and the public.^{710 711} EPA has not updated its mobile source BPT estimates to reflect these updates in time for this analysis. Instead, based on the recommendation of EPA staff, we use the same PM_{2.5} BPT estimates that we used in the NPRM to ensure consistency between the values corresponding to different source sectors. The BPT estimates used are based on the review of the 2009 PM ISA⁷¹² and 2012 PM ISA Provisional

⁷⁰² Environmental Protection Agency (EPA). 2018. Estimating the Benefit per Ton of Reducing PM_{2.5} Precursors from 17 Sectors. https://www.epa.gov/sites/production/files/2018-02/documents/sourceapportionmentbpttsd_2018.pdf; Wolfe et al. 2019. Monetized health benefits attributable to mobile source emissions reductions across the United States in 2025. <https://pubmed.ncbi.nlm.nih.gov/30296769/>; Fann et al. 2018. Assessing Human Health PM_{2.5} and Ozone Impacts from U.S. Oil and Natural Gas Sector Emissions in 2025. <https://www.ncbi.nlm.nih.gov/pmc/articles/PMC6718951/>.

⁷⁰³ The CAFE Model's emission source sectors follow a similar structure to the inputs from GREET. See Chapter 5.2 of the TSD accompanying this notice for further information.

⁷⁰⁴ CBD et al., at 5.

⁷⁰⁵ Although EPA and DOT's VSL values differ, DOT staff determined that using EPA's VSL was appropriate here, since it was already included in these monetized health impact values, which were best suited for the purposes of the CAFE Model.

⁷⁰⁶ See Environmental Protection Agency (EPA). 2018. Estimating the Benefit per Ton of Reducing PM_{2.5} Precursors from 17 Sectors. https://www.epa.gov/sites/production/files/2018-02/documents/sourceapportionmentbpttsd_2018.pdf.

⁷⁰⁷ Competitive Enterprise Institute, Docket No. NHTSA–2021–0053–1546, at 3.

⁷⁰⁸ U.S. Environmental Protection Agency (U.S. EPA). 2021a. Regulatory Impact Analysis for the Final Revised Cross-State Air Pollution Rule (CSAPR) Update for the 2008 Ozone NAAQS. EPA–452/R–21–002. March.

⁷⁰⁹ U.S. Environmental Protection Agency (U.S. EPA). 2021b. Estimating PM_{2.5}- and Ozone-Attributable Health Benefits. Technical Support Document (TSD) for the Final Revised Cross-State Air Pollution Rule Update for the 2008 Ozone Season NAAQS. EPA–HQ–OAR–2020–0272. March.

⁷¹⁰ U.S. Environmental Protection Agency (U.S. EPA). 2019a. Integrated Science Assessment (ISA) for Particulate Matter (Final Report, 2019). U.S. Environmental Protection Agency, Washington, DC, EPA/600/R–19/188, 2019.

⁷¹¹ U.S. Environmental Protection Agency (U.S. EPA). 2019a. Integrated Science Assessment (ISA) for Ozone and Related Photochemical Oxidants (Final Report). U.S. Environmental Protection Agency, Washington, DC, EPA/600/R–20/012, 2020.

⁷¹² U.S. Environmental Protection Agency (U.S. EPA). 2009. Integrated Science Assessment for

⁷⁰¹ CBD et al., Docket No. NHTSA–2021–0053–1572, at 5.

Assessment⁷¹³ and include a mortality risk estimate derived from the Krewski et al. (2009)⁷¹⁴ analysis of the American Cancer Society (ACS) cohort and nonfatal illnesses consistent with benefits analyses performed for the analysis of the final Tier 3 Vehicle Rule,⁷¹⁵ the final 2012 PM NAAQS Revision,⁷¹⁶ and the final 2017–2025 Light-duty Vehicle GHG Rule.⁷¹⁷ We expect this lag in updating our BPT estimates to have only a minimal impact on total PM benefits, since the underlying mortality risk estimate based on the Krewski study is identical to an updated PM_{2.5} mortality risk estimate derived from an expanded analysis of the same ACS cohort. We are aware of EPA's work to update its mobile source BPT estimates to reflect these recent updates for use in future rulemaking analyses, and will work further with EPA in future rulemakings to update and synchronize approaches to BPT estimates.

Auto Innovators also suggested additional sensitivity analysis of BPT inputs, citing the EPA Science Advisory Board's "recommended sensitivity analyses of alternative values of the dose-response function, differential toxicity by type of particle, and spatially-dependent VSL values."⁷¹⁸ We

Particulate Matter (Final Report). EPA-600-R-08-139F. National Center for Environmental Assessment—RTP Division, Research Triangle Park, NC. December. Available at: <http://cfpub.epa.gov/ncea/cfm/recordisplay.cfm?deid=216546>.

⁷¹³ U.S. Environmental Protection Agency (U.S. EPA). 2012. Provisional Assessment of Recent Studies on Health Effect of Particulate Matter Exposure. EPA/600/R-12/056F. National Center for Environmental Assessment—RTP Division, Research Triangle Park, NC. December. Available at: <https://cfpub.epa.gov/ncea/isa/recordisplay.cfm?deid=247132>.

⁷¹⁴ Krewski D., M. Jerrett, R.T. Burnett, R. Ma, E. Hughes, Y. Shi, et al. 2009. Extended Follow-Up and Spatial Analysis of the American Cancer Society Study Linking Particulate Air Pollution and Mortality. HEI Research Report, 140, Health Effects Institute, Boston, MA.

⁷¹⁵ U.S. Environmental Protection Agency (2014). Control of Air Pollution from Motor Vehicles: Tier 3 Motor Vehicle Emission and Fuel Standards Final Rule: Regulatory Impact Analysis, Assessment and Standards Division, Office of Transportation and Air Quality, EPA-420-R-14-005, March 2014. Available on the internet: <http://www3.epa.gov/otaq/documents/tier3/420r14005.pdf>.

⁷¹⁶ U.S. Environmental Protection Agency. (2012). Regulatory Impact Analysis for the Final Revisions to the National Ambient Air Quality Standards for Particulate Matter, Health and Environmental Impacts Division, Office of Air Quality Planning and Standards, EPA-452-R-12-005, December 2012. Available on the internet: <http://www3.epa.gov/ttnecas1/regdata/RIAs/finalria.pdf>.

⁷¹⁷ U.S. Environmental Protection Agency (U.S. EPA). (2012). Regulatory Impact Analysis: Final Rulemaking for 2017–2025 Light-Duty Vehicle Greenhouse Gas Emission Standards and Corporate Average Fuel Economy.

⁷¹⁸ Auto Innovators, Docket No. NHTSA-2021-0053-1492, at 92.

include other BPT values in one health effects sensitivity case described in Chapter 7 of the FRIA. Further sensitivity cases were not deemed necessary for the purposes of this analysis, since criteria pollutant health impacts make up a very small portion of overall benefits.

Our Children's Trust objected to using discount rates when monetizing health benefits, stating that "to apply a discount rate to monetized health impacts is also completely inappropriate and unlawful and discriminates against children."⁷¹⁹ The health impacts of exposure to criteria pollutants occur well after exposure to air pollution (*i.e.*, the impacts have long "latency periods"), and therefore it is appropriate to reflect some difference in timing (through discounting) in the monetized values.

We disagree with Our Children's Trust's assertion that applying a discount rate to health benefits is illegal. Our Children's Trust did not provide any specific laws that we were allegedly violating, nor are we aware of any such law. Guidance from OMB Circular A-4 recommends using discount rates of 3 and 7 percent in benefit-cost analyses and has been used for regulatory analyses for decades, including in the evaluation of regulations with health impacts similar to those of this final rule.

However, OMB Circular A-4 also acknowledges the ethical considerations involved in analyzing impacts occurring over intergenerational time horizons:

Special ethical considerations arise when comparing benefits and costs across generations. Although most people demonstrate time preference in their own consumption behavior, it may not be appropriate for society to demonstrate a similar preference when deciding between the well-being of current and future generations. Future citizens who are affected by such choices cannot take part in making them, and today's society must act with some consideration of their interest.⁷²⁰

Factoring in competing social interests presents additional difficulties in weighing these ethical considerations. As of this time, we include health benefits at the 3 percent as well as 7 percent discount rate and will consider the question of lower discount rates for health benefits in future analyses.

The CAFE Model health impacts inputs are based partially on the structure of the 2018 EPA source apportionment TSD, which reports benefits per ton values for the years

2020, 2025, and 2030. For the years in between the source years used in the input structure, the CAFE Model applies values from the closest source year. For instance, the model applies 2020 monetized health impact per ton values for calendar years 2020–2022 and applies 2025 values for calendar years 2023–2027. For some of the monetized health damage values, in order to match the structure of other impacts costs, we developed proxies for 7 percent discounted values for specific source sectors by using the ratio between a comparable sector's 3 and 7 percent discounted values. In addition, we used implicit price deflators from the Bureau of Economic Analysis (BEA) to convert different monetized estimates to 2018 dollars, to be consistent with the rest of the CAFE Model inputs.

This process is described in more detail in Chapter 6.2.2 of the TSD accompanying this final rule. In addition, the CAFE Model documentation contains more details of the model's computation of monetized health impacts. All resulting emissions damage costs for criteria pollutants are located in the Criteria Emissions Cost worksheet of the Parameters file.

(3) Reduction in Petroleum Market Externalities

By amending existing standards, this action will reduce domestic consumption of gasoline, producing a corresponding decrease in the Nation's demand for crude petroleum, a commodity that is traded actively in a worldwide market. U.S. consumption and imports of petroleum products have three potential effects on the domestic economy that are often referred to collectively as "energy security externalities." Increases in their magnitude are sometimes cited as possible social costs of increased U.S. demand for petroleum, and analogously, any reduction in their value in response to lower U.S. consumption or imports of petroleum represent potential economic benefits.

First, the U.S. accounts for a sufficiently large (although declining) share of global petroleum demand such that changes in domestic consumption of petroleum products can affect global petroleum prices. Any increase in global petroleum prices that results from higher U.S. gasoline demand will cause a transfer of revenue from consumers of petroleum to oil suppliers worldwide, because consumers throughout the world are ultimately subject to the higher global price that results. Although this transfer is simply a shift of resources that produces no change in global economic welfare, the financial

⁷¹⁹ Our Children's Trust, Docket No. NHTSA-2021-0053-1587, at 3.

⁷²⁰ OMB Circular A-4.

drain it produces on the U.S. economy is sometimes cited as an external cost of increased U.S. petroleum consumption because consumers of petroleum products are unlikely to consider it. Similarly, a decline in U.S. consumption of petroleum-derived transportation fuel will reduce global petroleum demand and exert some downward pressure on worldwide prices. Although the resulting savings to worldwide consumers of petroleum products is again a transfer—this time from oil producers to consumers—it may reduce the financial drain on the U.S. economy caused by domestic oil production and imports.

As the U.S. approaches self-sufficiency in petroleum production (the Nation became a net exporter of petroleum in 2020), any effect of reduced domestic demand on global petroleum prices increasingly results in a transfer from U.S. petroleum producers to domestic consumers of refined products.⁷²¹ Thus not only does it leave net U.S. welfare unaffected, it also ceases even to be a financial burden on the U.S. economy. In fact, as the U.S. becomes a larger net petroleum exporter, any transfer from global consumers to petroleum producers would become a financial *benefit* to the U.S. economy, although uncertainty in the Nation's long-term import-export balance makes it difficult to project precisely how these effects might change in response to increased consumption.

Higher U.S. petroleum consumption also increases domestic consumers' exposure to oil price shocks and by doing so impose potential costs on all U.S. petroleum users (including those outside the light duty vehicle sector, whose consumption would be unaffected by this final rule) from possible interruptions in the global supply of petroleum or rapid fluctuations in global oil prices. These potential costs arise from petroleum users' need to pay more for oil-based products, to switch energy sources, or adjust production methods rapidly in response to reduced supplies or higher prices, which they cannot recover once supplies are restored or prices return to pre-disruption levels, and from losses in economic output while supplies are disrupted. Because users of petroleum products are unlikely to consider the effect of their increased purchases on the risk of these effects, their probability-weighted (or "expected") economic value is often cited as an

external cost of increased U.S. consumption of petroleum products. Conversely, reducing domestic consumption of refined products reduces exposure to supply disruptions or rapid price changes and petroleum users' costs for adjusting rapidly to them, which will reduce the external economic costs associated with domestic petroleum consumption. When U.S. oil consumption is linked to the globalized and tightly interconnected oil market, as it is now, the only means of reducing the exposure of U.S. consumers to global oil shocks is to reduce their consumption. Thus the reduction in oil consumption driven by fuel economy standards creates an energy security benefit.

This benefit is the original purpose behind the CAFE standards. Oil prices are inherently volatile, in part because geopolitical risk affects prices. International conflicts, sanctions, civil conflicts targeting oil production infrastructure, pandemic-related economic upheaval, and cartels have all had dramatic and sudden effects on oil prices in recent years. U.S. net exporter status does not insulate U.S. drivers from higher gas prices, because those prices are currently largely determined by oil prices set in the globally integrated market. Given these dynamics, the effective policies to protect consumers from oil price spikes are those that reduce the oil-intensity of the economy, including fuel economy standards.

Finally, some analysts argue that domestic demand for imported petroleum may also influence U.S. military spending. Because the increased cost of military activities would not be reflected in the prices drivers pay at the gas pump, increased military spending to secure oil imports is often represented as a third category of external costs from increased U.S. petroleum consumption. NHTSA has received extensive comments to past actions on this topic.

Each of these three factors would be expected to decrease—albeit by a limited magnitude—as a consequence of decreasing U.S. petroleum consumption resulting from more stringent CAFE standards. TSD Chapter 6.2.4 provides a comprehensive explanation of the agency's analysis of these three impacts and explains how it values potential economic benefits from reducing each one. The agency's proposed rule also presented this same explanation and drew numerous comments, most asserting that the value the agency attached to reducing the expected economic costs of oil supply disruptions and price volatility was too low.

As one illustration of the comments that the agency received on this issue, the Applied Economics Clinic (AEC) argued on behalf of the California Attorney General and the CARB that the expert assessment of the likelihood of petroleum supply disruptions underlying the agency's estimate of macroeconomic disruption costs estimated disruption probabilities that were far too low to be consistent with recent experience, causing the agency's cost estimate to be unrealistically low. AEC also noted that NHTSA's estimates were presented as a single value without acknowledging the range of uncertainty customarily estimated to surround it, and that other estimates reported in the same source on which NHTSA relies for its disruption costs are significantly higher. AEC argued that the agency should return to using the estimates of disruption probabilities and expected costs from Oak Ridge National Laboratories (ORNL) that it had relied on in previous analyses, whose central value it estimated at more than twice the figure the agency used to analyze its proposed rule. However, the agency notes that both ORNL's estimates of supply disruption costs and the alternative estimates presented in the source NHTSA relies on use exactly the same type of expert elicitation of the probabilities and magnitudes of disruptions used in the study from which NHTSA's cost estimates were derived, and also reflect less up to date assumptions about other factors such as petroleum prices and global petroleum supply elasticities that affect its cost estimates. For these reasons, the agency's analysis of this final rule continues to rely on its earlier estimates.

In addition, AEC argues that net financial transfers between U.S. suppliers and consumers of petroleum products are unlikely to be zero in any single year because of year-to-year variation in U.S. gross imports and exports of petroleum, and that the agency's analysis should explicitly account for forecast variation in these volumes. The agency notes that this would force it to rely on inherently uncertain forecasts of U.S. and global petroleum production and demand, and in any case, would be unlikely to produce a significantly different outcome from the analysis presented here because AEC's assumption depends primarily on the Nation's net imports over the entire period it spans. Discounting of net transfers projected to occur in distant future years would also reduce their present values, particularly or distant future years.

Finally, AEC also argues that even if net dollar-valued revenue transfers

⁷²¹ See <https://www.eia.gov/energyexplained/oil-and-petroleum-products/imports-and-exports.php> (accessed March 17, 2022).

between U.S. consumers and suppliers are zero, their net welfare impacts will not necessarily be neutral and should be accounted for. The agency notes that while this assertion is correct, accounting for the true welfare rather than the financial consequences of revenue transfers would require detailed information on the income distributions of U.S. consumers of petroleum products and of equity holders (and other investors) in domestically based oil companies, as well as estimates of the marginal utility of income and its variation over the income spectrum. This level of detail is well beyond the scope of the agency's analyses of other, much more significant economic impacts of this final rule, and employing it would complicate the analysis and its interpretation enormously without a commensurate improvement in its usefulness to decision-makers or the public.

In the proposal, the agency reviewed its previous assumption that 90 percent of any reduction in domestic petroleum refining to produce gasoline that results from the proposal would reduce U.S. petroleum imports, with the remaining 10 percent reducing domestic production. The California Attorney General requested that we revisit this assumption, asserting that only a small portion of U.S. gasoline demand is supplied by foreign-refined oils today. The agency neglected to make this change in the analysis supporting the proposal, and has refrained from revising the analysis for the final rule. While we believe that there remains a strong case to assume that any reduction in refining of crude petroleum to produce gasoline would reduce U.S. oil imports, rather than changing U.S. petroleum output, we are going to continue to evaluate assumption given the concerns raised by the California Attorney General. In the interim, we will continue to assume that 90 percent of any reduction in domestic petroleum refining to produce gasoline that results from the proposal would reduce U.S. petroleum imports, with the remaining 10 percent reducing domestic production. We conducted a sensitivity analysis to scope the difference between the two assumptions and observed that the difference in estimated total and net benefits is less than 0.1 percent when viewed from either the model year or calendar year perspective and discounted at either 3 or 7 percent.⁷²²

(4) Changes in Labor

As vehicle prices rise, we expect consumers to purchase fewer vehicles

than they would have at lower prices. If manufacturers produce fewer vehicles as a consequence of lower demand, manufacturers may need less labor to produce their fleet and dealers may need less labor to sell the vehicles. Conversely, as manufacturers add equipment to each new vehicle, the industry will require labor resources to develop, sell, and produce additional fuel-saving technologies.⁷²³ We also account for the possibility that new standards could shift the relative shares of passenger cars and light trucks in the overall fleet. Since the production of different vehicles involves different amounts of labor, this shift impacts the quantity of estimated labor.

The analysis considers the direct labor effects that the CAFE standards have across the automotive sector. The facets include (1) dealership labor related to new light-duty vehicle unit sales; (2) assembly labor for vehicles, engines, and transmissions related to new vehicle unit sales; and (3) labor related to mandated additional fuel savings technologies, accounting for new vehicle unit sales. The labor utilization analysis is intentionally narrow in its focus and does not represent an attempt to quantify the overall labor or economic effects of this rulemaking because adjacent employment factors and consumer spending factors for other goods and services are uncertain and difficult to predict. We do not consider how direct labor changes may affect the macro economy and potentially change employment in adjacent industries. For instance, we do not consider possible labor changes in vehicle maintenance and repair, nor changes in labor at retail gas stations. We also do not consider possible labor changes due to raw material production, such as production of aluminum, steel, copper, and lithium, nor does the agency consider possible labor impacts due to changes in production of oil and gas, ethanol, and electricity.

Auto Innovators recommended NHTSA consider the geographic differences in employment losses and gains in its labor analysis and present additional results based on such regional differences. Auto Innovators pointed out that the impacts of BEVs on U.S. employment, specifically in gasoline engine and transmission plants and supply chains, as well as in the petroleum and biofuels sector, may differ based on region. They also noted that the employment impacts of BEV

production elsewhere should be studied.⁷²⁴ As discussed above, NHTSA's labor utilization analysis is intentionally narrow in focus and all effects are reported at a national level. While we appreciate the benefits of identifying how employment may shift between geographic areas as different suites of technologies are employed, identifying where to deploy resources and trainings within the Nation is outside the scope of this rulemaking. We may consider expanding the scope of the labor utilization analysis or reporting subnational results in future rulemaking analyses.

All labor effects are estimated and reported at a national level, in person-years, assuming 2,000 hours of labor per person-year.⁷²⁵ These labor hours are not converted into monetized values because we assume that the labor costs are included into a new vehicle's purchasing price. The analysis estimates labor effects from the forecasted CAFE Model technology costs and from review of automotive labor for the MY 2020 fleet. The agency uses information about the locations of vehicle assembly, engine assembly, and transmission assembly, and the percent of U.S. content of vehicles collected from American Automotive Labeling Act (AALA) submissions for each vehicle in the reference fleet.⁷²⁶ The analysis assumes the portion of parts that are made in the U.S. will remain constant for each vehicle as manufacturers add fuel-savings technologies. This should not be misconstrued as a prediction that the percentage of U.S.-made parts—and by extension U.S. labor—will remain constant, but rather that the agency does not have a clear basis to project where future productions may shift. The analysis also uses data from the 2016 National Automotive Dealers Association (NADA) annual report to derive dealership labor estimates. We considered using data from NADA's 2020 report but concluded that 2020 was too affected by COVID-19 to be an appropriate basis to project future dealership labor values.

In sum, the analysis shows that the increased labor from production of new technologies used to meet the Preferred Alternative will outweigh any decreases attributable to the change in new vehicle sales. For a full description of the process the agency uses to estimate labor impacts, see TSD Chapter 6.2.5.

⁷²⁴ Auto Innovators, at 122.

⁷²⁵ The agencies recognize a few local production facilities may contribute meaningfully to local economies, but the analysis reports only on national effects.

⁷²⁶ 49 CFR part 583.

⁷²³ For the purposes of this analysis, DOT assumes a linear relationship between labor and production volumes.

⁷²² See FRIA Chapter 7.

3. Costs and Benefits not Quantified

In addition to the costs and benefits described above, Table III–37 and Table III–38 each include two line-items without values. The first is maintenance and repair costs. Many of the technologies manufacturers apply to vehicles to meet CAFE standards are sophisticated and costly. The technology costs capture only the initial or “upfront” costs to incorporate this equipment into new vehicles; however, if the equipment is costlier to maintain or repair—which is likely either because the materials used to produce the equipment are more expensive or the equipment is significantly more complex than less fuel efficient alternatives and requires more time and labor—then consumers will also experience increased costs throughout the lifetime of the vehicle to keep it operational. The agency does not calculate the additional cost of repair and maintenance currently because it lacks a basis for estimating the incremental change attributable to the standards. NHTSA sought comment on how to estimate these costs from the public but did not receive any suggestions.

The second item is the potential tradeoff with other vehicle attributes that could create an opportunity cost for some consumers. In addition to fuel economy, potential buyers of new cars and light trucks value other features such as their seating and cargo-carrying capacity, ride comfort, safety, and performance. Changing some of these other features, however, can sometimes affect vehicles’ fuel economy, so manufacturers will carefully consider any tradeoffs among them when deciding how to comply with stricter CAFE standards. Currently the analysis assumes that these vehicle attributes will not change as a result of these rules,⁷²⁷ but in practice manufacturers may make practical design changes to meet the standards and minimize their compliance costs.

If manufacturers do so, they may lower compliance costs relative to those estimated here,⁷²⁸ but the change to other attributes could in theory involve an opportunity cost to consumers who value specific attributes, if those consumers cannot purchase a vehicle

with those attributes. Similarly, if manufacturers could use the same technology to either improve efficiency or improve performance relative to current attributes, and choose to use the technology only to improve efficiency, the consumer may not experience the performance enhancement. Of course, unless automakers reach an absolute technology limit, which has not been observed, and unless there is a technical or engineering constraint that makes it impossible or much more expensive to add additional performance features after increasing fuel economy, they can still improve other vehicle attributes while improving fuel economy—as is always the case, those improvements would come at a cost, but that cost would be borne only by consumers who value the attribute improvement more than its cost. Because fuel efficiency improvements can save consumers money on net by reducing fuel expenditures, assuming consumers are completely financing their vehicle purchases, the fuel economy improvements can only reduce a consumer’s “budget” for other vehicle attributes to the extent that the monthly car payment increases due to the improvements by more than the fuel savings the technologies deliver.

The agency has previously attempted to model the potential opportunity cost associated with changes in other vehicle attributes in sensitivity analyses. In those other rulemakings, the agency acknowledged that it is extremely difficult to quantify the potential changes to other vehicle attributes. To accurately do so requires extensive projections about which and how much of other attributes will be altered and a detailed accounting of how much value consumers assigned to those attributes. The agency modeled the opportunity cost associated with changes in other vehicle attributes using published empirical estimates of tradeoffs between higher fuel economy and improvements to other attributes, together with estimates of the values buyers attach to those attributes. The agency does not believe this is an appropriate methodology since there is considerable uncertainty in the literature about how much fuel economy consumers are willing to pay for and how consumers value other vehicle attributes. We note, for example, a recent EPA-commissioned study that “found very little useful consensus” regarding “estimates of the values of various vehicle attributes,” which ultimately

were “of little use for informing policy decisions.”⁷²⁹

As noted above, an analysis of opportunity costs optimally would need to assess compliance with these standards while allowing manufacturers to adjust vehicle attributes. This requires detailed information about how much different consumers value various vehicle attributes, which is not currently available. Such an analysis could show lower compliance costs for the standards, but could identify any opportunity costs where consumers value other vehicle attributes that are not incorporated into the vehicle they purchase.

Still, there is some evidence that consumers are myopic with respect to future savings well beyond any attribute tradeoff. Gillingham et al. (2021) use an error in fuel efficiency marketing and subsequent change in the market equilibrium price for the vehicles in question to assess the willingness to pay for fuel efficiency and find that consumers are only willing to pay \$0.16–0.39 per discounted value of a dollar of fuel savings. The intriguing feature of this study is that it uses identical cars made by Hyundai and Kia, which means the features of the car with and without the reported fuel savings are identical and the discount paid for future fuel saving cannot be attributed to an omitted feature. Therefore, the undervaluation observed in this study is not due to consumers valuing other vehicle attributes more than fuel economy. The findings of this paper are consistent with consumers displaying myopia—a term they use to “describe a range of behavioral phenomena that could cause undervaluation.”

In comments to the NPRM, IPI provided extensive comments on this topic. IPI cited the 2019 EPA Automotive Trends Report as showing that horsepower and fuel economy have both steadily improved since 2008, and cited EPA’s finding in the Midterm Evaluation that simultaneous improvements in fuel economy and other vehicle attributes likely indicates that any historical trade-off between the two is far less likely to be present in the context of advanced vehicle engines. IPI also stated that many technologies that improve fuel economy also improve other vehicle attributes, and those benefits would offset any opportunity costs. Further, IPI stated that:

Economic research has long recognized the various implicit subsidies and externalities

⁷²⁹ EPA, Consumer Willingness to Pay for Vehicle Attributes: What is the Current State of Knowledge? (2018).

⁷²⁷ See TSD Chapter 2.4.5.

⁷²⁸ See Kate S. Whitefoot et al., Compliance by Design: Influence of Acceleration Trade-Offs on CO₂ Emissions and Costs of Fuel Economy and Greenhouse Gas Regulations, 51 Env’t Sci. & Tech. 10,307 (2018); Gloria Helfand & Reid Dorsey-Palmateer, The Energy Efficiency Gap in EPA’s Benefit-Cost Analysis of Vehicle Greenhouse Gas Regulations: A Case Study, 6 J. Benefit Cost Analysis 432 (2015).

imposed on society by vehicles. These include: Accidents, road congestion, road and parking construction and maintenance costs, the space used for parking, and pollution. Drivers with higher horsepower vehicles are much more likely to speed—by 10 miles per hour or more—increasing the risk of accidents, damages, and fatalities. Vehicles with features that allow faster acceleration also cause a greater number of and more consequential accidents. Vehicles with internal combustion engines are more dangerous than those with electric engines due to the latter's additional crumple space. Heavier vehicles also increase the cost of road maintenance and repair. Vehicles with greater acceleration also may be driven in ways that consume more fuel and so emit more pollution. And as discussed below, certain status features like horsepower impose negative positional externalities on other drivers.⁷³⁰

IPI further states that these negative externalities associated with other vehicle attributes would also offset opportunity costs associated with reduced deployment of these attributes where valued by consumers.

CFA commented that the agency should include a \$.90 macroeconomic stimulus for every dollar of net reduction in driving expenses.⁷³¹ CFA did not provide any details or support for their claim, nor did it describe how to handle factors like up-front costs. We find CFA's argument without support.

A number of commenters argued that the agency should include the ancillary costs of electric vehicles, such as building additional charging stations,⁷³² improving the grid,⁷³³ and potential tax credits given to individuals that purchase electric vehicles.⁷³⁴ As noted elsewhere in this rule and within many of the same comments, many of these issues are already being addressed by government at the Federal and state-level. Counting those costs here would be duplicative to include those costs in this rulemaking.

H. Simulating Safety Effects of Regulatory Alternatives

The primary objective of CAFE standards is to achieve maximum feasible fuel economy, thereby reducing fuel consumption. In setting standards to achieve this intended effect, the potential of the standards to affect vehicle safety is also considered. As a safety agency, we have long considered the potential for adverse safety

consequences when establishing CAFE standards.

This safety analysis includes the comprehensive measure of safety impacts from three factors:

1. Changes in Vehicle Mass. Similar to previous analyses, we calculate the safety impact of changes in vehicle mass made to the standards. Statistical analysis of historical crash data indicates reducing mass in heavier vehicles generally improves safety, while reducing mass in lighter vehicles generally reduces safety. Our crash simulation modeling of vehicle design concepts for reducing mass revealed similar effects. These observations align with the role of mass disparity in crashes; when vehicles of different masses collide, the smaller vehicle will experience a larger change in velocity (and, by extension, force), which increases the risk to its occupants. As discussed below, in our analysis, any effect of changes in mass on vehicle safety was not sufficiently precisely estimated to distinguish it from zero statistically.

2. Impacts of Vehicle Prices on Fleet Turnover. Vehicles have become safer over time through a combination of new safety regulations and voluntary safety improvements. We expect this trend to continue as emerging technologies, such as advanced driver assistance systems, are incorporated into new vehicles. Safety improvements will likely continue regardless of changes to CAFE standards. As discussed in Section III.E.2, technologies added to comply with fuel economy standards have an impact on vehicle prices, therefore slowing the acquisition of newer vehicles and retirement of older ones. The delay in fleet turnover caused by the effect of new vehicle prices affects safety by slowing the penetration of new safety technologies into the fleet.

The standards also influence the composition of the light-duty fleet. As the safety provided by light trucks, SUVs and passenger cars responds differently to technology that manufacturers employ to meet the standards—particularly mass reduction—fleets with different compositions of body styles will have varying numbers of fatalities, so changing the share of each type of light-duty vehicle in the projected future fleet impacts safety outcomes.

3. Increased driving because of better fuel economy. The “rebound effect” predicts consumers will drive more when the cost of driving declines. More stringent standards reduce vehicle operating costs, and in response, some consumers may choose to drive more. Additional driving increases exposure to risks associated with motor vehicle travel, and this added exposure translates into higher fatalities and injuries.

The contributions of the three factors described above generate the differences in safety outcomes among regulatory alternatives.⁷³⁵ Our analysis makes

extensive efforts to allocate the differences in safety outcomes between the three factors. Fatalities expected during future years under each alternative are projected by deriving a fleet-wide fatality rate (fatalities per vehicle mile of travel) that incorporates the effects of differences in each of the three factors from baseline conditions and multiplying it by that alternative's expected VMT. Fatalities are converted into a societal cost by multiplying fatalities with the DOT-recommended value of a statistical life (VSL) supplemented by economic impacts that are external to VSL measurements. Traffic injuries and property damage are also modeled directly using the same process and valued using costs that are specific to each injury severity level.

All three factors influence predicted fatalities, but only two of them—changes in vehicle mass and in the composition of the light-duty fleet in response to changes in vehicle prices—impose increased risks on drivers and passengers that are not compensated for by accompanying benefits. In contrast, increased driving associated with the rebound effect is a consumer choice that reveals the benefit of additional travel. Consumers who choose to drive more have apparently concluded that the utility of additional driving exceeds the additional costs for doing so, including the crash risk that they perceive additional driving involves. As discussed in Chapter 7 of the accompanying TSD, the benefits of rebound driving are accounted for by offsetting a portion of the added safety costs.

We categorize safety outcome through three measures of light-duty vehicle safety: Fatalities to occupants occurring in crashes, serious injuries sustained by occupants, and the number of vehicles involved in crashes that cause property damage but no injuries. Counts of fatalities to occupants of automobiles and light trucks are obtained from the Fatal Accident Reporting System (FARS). Estimates of the number of serious injuries to drivers and passengers of light-duty vehicles are tabulated from the General Estimates System (GES), an annual sampling of motor vehicle crashes occurring throughout the U.S. Weights for different types of crashes were used to expand the samples of each type to

performance, we are discussing the intrinsic safety of a vehicle based on its design and features, while safety outcome is used to describe whether a vehicle has been involved in an accident and the severity of the accident. While safety performance influences safety outcomes, other factors such as environmental and behavioral characteristics also play a significant role.

⁷³⁰ IPI, Docket No. NHTSA–2021–0053–1579–A1, at 22.

⁷³¹ CFA, Docket No. NHTSA–2021–0053–1535, at 5.

⁷³² See, e.g., NATSO and SIGMA, NHTSA–2021–0053–1570, at 10.

⁷³³ Walter Kreucher, NHTSA–2021–0053–0013, at 14.

⁷³⁴ *Id.* At 14.

⁷³⁵ The terms safety performance and safety outcome are related but represent different concepts. When we use the term safety

estimates of the total number of crashes occurring during each year. Finally, estimates of the number of automobiles and light trucks involved in property damage-only (PDO) crashes each year were also developed using GES.

1. Changes in Vehicle Mass

Similar to previous analyses, we calculate the safety impact of changes in vehicle mass made to reduce fuel consumption and comply with the standards. While reduction in mass should have a beneficial safety effect overall by reducing average fleet mass, a statistical analysis of historical crash data indicates that reducing mass in heavier vehicles generally improves safety, while reducing mass in lighter vehicles generally reduces safety. Our crash simulation modeling of vehicle design concepts for reducing mass revealed similar effects. These observations align with the role of mass disparity in crashes: When vehicles of different masses collide, the smaller vehicle will experience a larger change in velocity (and, by extension, force), which increases the risk to its occupants. As discussed below, while NHTSA's current analysis did not find a statistically significant relationship between mass and safety, it did find results that are directionally consistent with previous NHTSA and other studies, illustrating a common pattern across all studies is that changes in mass disparity are associated with changes in motor vehicle safety: Increased disparity increases fatality risk, while decreased disparity decreases risk. The historical relationship may be changing, however, and merits ongoing study, which NHTSA is pursuing.

2. Mass Reduction Impacts

Vehicle mass reduction can be one of the more cost-effective means of improving fuel economy, particularly for makes and models not already built with much high-strength steel or aluminum closures or low-mass components. Manufacturers have stated that they will continue to reduce vehicle mass to meet more stringent standards, and therefore, this expectation is incorporated into the modeling analysis supporting the standards. Safety trade-offs associated with mass-reduction have occurred in the past, particularly before CAFE standards were attribute-based; past safety trade-offs may have occurred because manufacturers chose at the time, in response to CAFE

standards, to build smaller and lighter vehicles. In cases where fuel economy improvements were achieved through reductions in vehicle size and mass, the smaller, lighter vehicles did not fare as well in crashes as larger, heavier vehicles, on average. We now, however, use attribute-based standards, in part to reduce or eliminate the incentive to downsize vehicles to comply with CAFE standards, but we must continue to be mindful of the possibility of related safety trade-offs.

For this final rule, we employed the modeling technique developed in the 2016 Puckett and Kindelberger report to analyze the updated crash and exposure data by examining the cross sections of the societal fatality rate per billion vehicle miles of travel (VMT) by mass and footprint, while controlling for driver age, gender, and other factors, in separate logistic regressions for five vehicle groups and nine crash types.⁷³⁶ We utilized the relationships between weight and safety from this analysis, expressed as percentage increases in fatalities per 100-pound weight reduction (which is how mass reduction is applied in the technology analysis; see Section III.D.4, to examine the weight impacts applied in this CAFE analysis. The effects of mass reduction on safety were estimated relative to (incremental to) the regulatory baseline in the CAFE analysis, across all vehicles for MY 2021 and beyond.

In computing the impact of changes in mass on safety, we are faced with competing challenges. Research has consistently shown that mass reduction affects "lighter" and "heavier" vehicles differently across crash types. The 2016 Puckett and Kindelberger report found mass reduction concentrated among the heaviest vehicles is likely to have a beneficial effect on overall societal fatalities, while mass reduction concentrated among the lightest vehicles is likely to have a detrimental effect on fatalities. This represents a relationship between the dispersion of mass across vehicles in the fleet and societal fatalities: Decreasing dispersion is associated with a decrease in fatalities. Mass reduction in heavier vehicles is more beneficial to the occupants of lighter vehicles than it is harmful to the occupants of the heavier vehicles. Mass reduction in lighter vehicles is more harmful to the occupants of lighter vehicles than it is

beneficial to the occupants of the heavier vehicles.

To accurately capture the differing effect on lighter and heavier vehicles, we split vehicles into lighter and heavier vehicle classifications in the analysis. However, this poses a challenge of producing statistically meaningful results. There are limited relevant crash data to use for the analysis. Each partition of the data reduces the number of observations per vehicle classification and crash type, and thus reduces the statistical robustness of the results. The methodology we employed was designed to balance these competing forces as an optimal trade-off to accurately capture the impact of mass-reduction across vehicle curb weights and crash types while preserving the potential to identify robust estimates.

The boundary between "lighter" and "heavier" cars is 3,201 pounds (which is the median mass of MY 2004–2011 cars in fatal crashes in CY 2006–2012, up from 3,106 pounds for MY 2000–2007 cars in CY 2002–2008 in the 2012 NHTSA safety database, and up from 3,197 pounds for MY 2003–2010 cars in CY 2005–2011 in the 2016 NHTSA safety database). Likewise, for truck-based LTVs, curb weight is a two-piece linear variable with the boundary at 5,014 pounds (again, the MY 2004–2011 median, higher than the median of 4,594 pounds for MY 2000–2007 LTVs in CY 2002–2008 and the median of 4,947 pounds for MY 2003–2010 LTVs in CY 2005–2011). CUVs and minivans are grouped together in a single group covering all curb weights of those vehicles; as a result, curb weight is formulated as a simple linear variable for CUVs and minivans. Historically, CUVs and minivans have accounted for a relatively small share of new-vehicle sales over the range of the data, resulting in fewer crash data available than for cars or truck-based LTVs. In sum, vehicles are distributed into five groups by class and curb weights: Passenger cars <3,201 pounds; passenger cars 3,201 pounds or greater; truck-based LTVs <5,014 pounds; truck-based LTVs 5,014 pounds or greater; and all CUVs and minivans.

Table III–39 presents the estimated percent increase in U.S. societal fatality risk per ten billion VMT for each 100-pound reduction in vehicle mass, while holding footprint constant, for each of the five vehicle classes.

⁷³⁶ Puckett, S.M. and Kindelberger, J.C. (2016, June). Relationships between Fatality Risk, Mass,

and Footprint in Model Year 2003–2010 Passenger Cars and LTVs—Preliminary Report. (Docket No.

2016–0068). Washington, DC: National Highway Traffic Safety Administration.

Table III-39 – Fatality Increase (%) per 100-Pound Mass Reduction While Holding Footprint Constant - MY 2004-2011, CY 2006-2012

Vehicle Class	Point Estimate	95% Confidence Bounds
Cars < 3,201 pounds	1.20	-.35 to +2.75
Cars > 3,201 pounds	0.42	-.67 to +1.50
CUVs and minivans	-0.25	-1.55 to +1.04
Truck-based LTVs < 5,014 pounds	0.31	-.51 to +1.13
Truck-based LTVs > 5,014 pounds	-0.61	-1.46 to +.25

Techniques developed in the 2011 (preliminary) and 2012 (final) Kahane reports have been retained to test statistical significance and to estimate 95 percent confidence bounds (sampling error) for mass effects and to estimate the combined annual effect of removing 100 pounds of mass from every vehicle (or of removing different amounts of mass from the various classes of vehicles), while holding footprint constant. Confidence bounds estimate only the sampling error internal to the data used in the specific analysis that generated the point estimate. Point estimates are also sensitive to the modification of components of the analysis, as discussed at the end of this section. However, this degree of uncertainty is methodological in nature rather than statistical.

None of the estimated effects has 95-percent confidence bounds that exclude zero, and thus are not statistically significant at the 95-percent confidence level. We have evaluated these results and provided them for the purposes of transparency. Sensitivity analyses have confirmed that the exclusion of these statistically insignificant results would not affect our policy determination, because the net effects of mass reduction on safety costs are small relative to predominant estimated benefit and cost impacts. Among the estimated effects, the most important effects of mass reduction are, as expected, concentrated among the lightest and heaviest vehicles. Societal fatality risk is estimated to: (1) Increase by 1.2 percent if mass is reduced by 100 pounds in the lighter cars; and (2) decrease by 0.61 percent if mass is reduced by 100 pounds in the heavier truck-based LTVs. These estimates align with the predominant view regarding the relationship between mass disparity in the vehicle fleet and societal fatalities: All else being equal, making the heaviest vehicles lighter (*i.e.*,

reducing mass disparity in the fleet) will reduce societal fatalities, while making the lightest vehicles lighter (*i.e.*, increasing mass disparity) will increase societal fatalities. IPI commented that we “should give additional weight to externalities such as pedestrian fatalities and the impact of increased weight distribution between vehicles.”⁷³⁷ Pedestrian fatalities are weighted within the above analysis directly proportional to their frequency among all societal fatalities involving light-duty vehicles. Any change to the weighting of pedestrian fatalities would thus involve valuing the societal cost of a pedestrian fatality as being worth a different amount from other fatalities involving light-duty vehicle crashes. IPI did not provide a basis to support their proposal to value fatalities based on occupancy status differently. We are confident that the current (and historical) specification of relationships among vehicle curb weights and societal fatality risk represents the role of mass disparity in societal fatality risk appropriately, by scaling societal fatality risk as a positive function of mass disparity through the intuitive coefficients for the lightest and heaviest vehicles (and through muted coefficients for vehicles with mass closer to the median).

The ACC commented that groups including NAS/NASEM have noted that future improvements in vehicle design could weaken the relationship between mass disparity and societal fatality rates over time.⁷³⁸ We acknowledge this view, and remain confident that our approach is the best available representation of the relationship between mass disparity and societal fatality rates subject to the data available for analysis, and note again that in our analysis, any effect of changes in mass

⁷³⁷ IPI, Docket No. NHTSA–2021–0053–1579, at 3, 22.

⁷³⁸ ACC, Docket No. NHTSA–2021–0053–1564–A1, at 7.

on vehicle safety was not sufficiently precisely estimated to distinguish it from zero at all standard confidence levels used in the scientific literature.

Multiple commenters proposed that, due to the limited statistical significance of the estimates, it would be more appropriate to assume that changes in vehicle mass in response to CAFE standards will have no effect on societal fatalities.⁷³⁹ NHTSA’s current analysis did not find a statistically significant relationship between mass and safety. This may reflect the effects of a decreased sample size (the current study was based on 32 percent fewer fatal cases than the Kahane 2012 study), as well as possible mitigating effects from newer safety technologies or vehicle designs. While not finding statistical significance, NHTSA’s current study did find results that are directionally consistent with previous NHTSA studies and a fleet simulation study by George Washington University.⁷⁴⁰ The common pattern across all studies is that changes in mass disparity are associated with changes in motor vehicle safety: Increased disparity increases fatality risk, while decreased disparity decreases risk. The agency will

⁷³⁹ IPI, at 30–1; Consumer Reports, Docket No. NHTSA–2021–0053–1576, Appendix 9, at 17–8; CARB, Docket No. NHTSA–2021–0053–1537, Appendix 11, at 269; CBD et al., Docket No. NHTSA–2021–0053–1572, Appendix 2, at 20; CBD et al., Appendix 1, at 4.

⁷⁴⁰ In response to questions of whether designs and materials of more recent model year vehicles may have weakened the historical statistical relationship between mass, size, and safety, NHTSA updated its public database for statistical analysis consisting of crash data. The database incorporates the full range of real-world crash types. NHTSA also sponsored a study conducted by George Washington University to develop a fleet simulation model and study the impact and relationship of light-weighted vehicle design with crash injuries and fatalities. That study is discussed in detail in Chapter 7.1.5 of the TSD. The study focused on vehicles from MY 2001 to MY 2011, as discussed in the TSD, and found results that are directionally consistent with NHTSA’s statistical analyses of vehicle mass and fatality risk.

continue to conduct research on the effects of mass disparity on vehicle safety in an effort to identify the impacts of evolving vehicle fleets.

We have assessed whether the inclusion of these results would affect the overall analysis. Because the impacts are very small, we concluded that it does not have a significant effect on the analysis or any effect on the choice of standards. Given this conclusion, we maintain that it is reasonable for the analysis to use the best available estimates of the impacts of mass reduction that results from changes in mass disparities on crash fatalities, even if the estimates are not statistically significant at the 95-percent confidence level. The estimated statistical significance is limited, but the results offer some evidence that the relevant point estimates are meaningfully different from zero (*e.g.*, approximately five to six times more likely to be non-zero than zero). They are also consistent with a time series of estimates that represent a relationship that is consistent with predominant views regarding mass disparity. We believe it would be inappropriate to ignore these data or to use values of zero for the rulemaking analysis. Specifically, negative point estimates for heavier LTVs and positive point estimates for lighter passenger cars have been found consistently across prior rulemakings. Smaller estimates corresponding to vehicles near the median of the fleet curb weight distribution are likely to be less informative due to both statistical (*i.e.*, small coefficients are less likely to be statistically significant for a given level of sampling error) and physical (*i.e.*, a given change in mass will have a smaller effect on societal fatalities for vehicles near the median mass) concerns.

An additional factor supporting continuing to quantify the safety impacts related to changes in mass is the sensitivity analysis including passenger cars with AWD summarized below; when including cars with AWD, the estimated coefficients are likewise consistent with previous NHTSA analyses and have statistical significance near the 95-percent confidence level. Chapter 5 of the FRIA discusses four sensitivity analyses that were presented for public comment in the NPRM. We did not identify any comments on the alternative approaches; in turn, we will defer the decision whether to incorporate the results into the CAFE Model to subsequent rulemakings. The relevant alternative with respect to statistical significance centers on aligning

passenger cars with the rest of the sample by including cars that are equipped with AWD. In previous analyses, passenger cars with AWD were excluded from the analysis because they represented a sufficiently low share of the vehicle fleet that statistical relationships between AWD status and societal fatality risk were highly prone to being conflated with other factors associated with AWD status (*e.g.*, location, luxury vehicle status). However, the share of AWD passenger cars in the fleet has grown. Approximately one-quarter of the passenger cars in the database have AWD, compared to an approximately five-percent share in the MY 2000–2007 database. Furthermore, all other vehicle types in the analysis include AWD as an explanatory variable. Thus, we find expanding the sample size to include a considerable portion of the real-world fleet (*i.e.*, passenger cars with AWD) to be a meaningful consideration.

Including passenger cars with AWD in the analysis has little effect on the point estimate for lighter passenger cars (increase in societal fatality rates of approximately 1.1 percent per 100-pound mass reduction, versus 1.2 percent in the central analysis). However, this revision has a strong effect on the point estimate for heavier passenger cars (increase in societal fatality rates of between 0.84 and 0.89 percent per 100-pound mass reduction, versus 0.42 percent in the central analysis). This result supports a hypothesis that, after taking AWD status into account, mass reduction in heavier passenger cars is a more important driver of societal fatality rates than previously estimated. Although this result could be spurious, estimated 95-percent confidence bounds (from –0.57 to 2.80 percent for lighter passenger cars, and from –0.14 to 1.82 percent for heavier passenger cars for the CYs evaluated in the sensitivity analysis) indicate that accounting for AWD status reduces uncertainty in the point estimate.

A more detailed description of the mass-safety analysis can be found in Chapter 7 of the accompanying TSD.

3. Sales/Scrapage Impacts

The sales and scrapage responses to higher vehicle prices discussed in Section III.E.2 have important safety consequences and influence safety through the same basic mechanism, fleet turnover. In the case of the scrapage response, delaying fleet turnover keeps drivers in older vehicles which tend to

be less safe than newer vehicles.⁷⁴¹ Similarly, the sales response slows the rate at which newer vehicles, and their associated safety improvements, enter the on-road population. The sales response also influences the mix of vehicles on the road—with more stringent CAFE standards leading to a higher share of light trucks sold in the new vehicle market, assuming all else is equal. This occurs because there is diminishing value to marginal improvements in fuel economy (there are fewer gallons to be saved), and as the difference in consumption between light trucks and passenger cars diminishes, the other attributes of the trucks will likely lead to increases in their market share—especially under lower gas prices. Light trucks have higher rates of fatal crashes when interacting with passenger cars and, as earlier discussed, different directional responses to mass reduction technology based on the existing mass and body style of the vehicle.

Any effects on fleet turnover (either from delayed vehicle retirement or deferred sales of new vehicles) will affect the distribution of both ages and model years present in the on-road fleet. Because each of these vintages carries with it inherent rates of fatal crashes, and newer vintages are generally safer than older ones, changing that distribution will change the total number of on-road fatalities under each regulatory alternative. Similarly, the dynamic fleet share model captures the changes in the fleet's composition of cars and trucks. As cars and trucks have different fatality rates, differences in fleet composition across the alternatives will affect fatalities.

At the highest level, the agency calculates the impact of the sales and scrapage effects by multiplying the VMT of a vehicle by the fatality risk of that vehicle. For this analysis, calculating VMT is rather simple: The agency uses the distribution of miles calculated in TSD Chapter 4.3. The trickier aspect of the analysis is creating fatality rate coefficients. The fatality risk measures the likelihood that a vehicle will be involved in a fatal accident per mile driven. The agency calculates the fatality risk of a vehicle based on the vehicle's model year, age, and style, while controlling for factors which are

⁷⁴¹ See Passenger Vehicle Occupant Injury Severity by Vehicle Age and Model Year in Fatal Crashes, Traffic Safety Facts Research Note, DOT–HS–812–528, National Highway Traffic Safety Administration, April 2018, and The Relationship Between Passenger Vehicle Occupant Injury Outcomes and Vehicle Age or Model Year in Police-Reported Crashes, Traffic Safety Facts Research Note, DOT–HS–812–937, National Highway Traffic Safety Administration, March, 2020.

independent of the intrinsic nature of the vehicle, such as behavioral characteristics. Using this same approach, the agency designed separate models for fatalities, non-fatal injuries, and property damaged vehicles.

The fatality risk projections described above capture the historical evolution of safety. Given that modern technologies are proliferating faster than ever and offer greater safety benefits than traditional safety improvements, the agency augmented the fatality risk projections with knowledge about forthcoming safety improvements. The agency applied detailed empirical estimates of the market uptake and improving effectiveness of crash avoidance technologies to estimate their effect on the fleet-wide fatality rate, including explicitly incorporating both the direct effect of those technologies on the crash involvement rates of new vehicles equipped with them, as well as the “spillover” effect of those technologies on improving the safety of occupants of vehicles that are not equipped with these technologies.⁷⁴²

The agency’s approach to measuring these impacts is to derive effectiveness rates for these advanced crash-avoidance technologies from safety technology literature. The agency then applies these effectiveness rates to specific crash target populations for which the crash avoidance technology is designed to mitigate and adjusted to reflect the current pace of adoption of the technology, including the public commitment by manufacturers to install these technologies. The products of these factors, combined across all 6 advanced technologies, produce a fatality rate reduction percentage that is applied to the fatality rate trend model discussed above, which projects both vehicle and non-vehicle safety trends. The combined model produces a projection of impacts of changes in vehicle safety technology as well as behavioral and infrastructural trends. A much more detailed discussion of the methods and inputs used to make these projections of safety impacts from advanced technologies is included in Chapter 7 of the accompanying TSD.

⁷⁴² These technologies included Forward Collision Warning (FCW), Crash Imminent Braking (CIB), Dynamic Brake Support (DBS), Pedestrian AEB (PAEB), Rear Automatic Braking, Semi-automatic Headlamp Beam Switching, Lane Departure Warning (LDW), Lane Keep Assist (LKA), and Blind Spot Detection (BSD). While Autonomous vehicles offer the possibility of significantly reducing or eventually even eliminating the effect of human error in crash causation, a contributing factor in roughly 94 percent of all crashes, there is insufficient information and certainty regarding autonomous vehicles eventual impact to include them in this analysis.

Securing America’s Future Energy commented that our analysis should account for improvements in safety over time as crash-avoidance technologies become more prevalent in the vehicle fleet.⁷⁴³ We agree with this approach, and have accounted for this expected effect in this and the previous rulemaking by projecting baseline fatality and injury rates to decrease as a function of the adoption of crash-avoidance technologies.

4. Rebound Effect Impacts

The additional VMT resulting from the rebound effect is accompanied by more exposure to risk, though rebound miles are not imposed on consumers by regulation. They are a freely chosen activity resulting from reduced vehicle operational costs and reflect the perceived benefit of additional travel. Consumers who choose to drive more have concluded that the utility of additional driving exceeds the additional costs for doing so, including the crash risk that they perceive additional driving involves. As such, we believe a large portion of the safety risks associated with additional driving are offset by the benefits drivers gain from added driving. The level of risk internalized by drivers is uncertain. This analysis assumes that consumers internalize 90 percent of this risk, which mostly offsets the societal impact of any added fatalities from this voluntary consumer choice. A more detailed discussion of the rebound effect is contained in TSD Chapter 7.4.

5. Value of Safety Impacts

Fatalities, nonfatal injuries, and property damage crashes are valued as a societal cost within the CAFE Model’s cost and benefit accounting. Their value is based on the comprehensive value of a fatality, which includes lost quality of life and is quantified in the value of a statistical life (VSL) as well as economic consequences such as medical and emergency care, insurance administrative costs, legal costs, and other economic impacts not captured in the VSL alone. These values were derived from data in Blincoe et al. (2015), adjusted to 2018 dollars, and updated to reflect the official DOT guidance on the value of a statistical life. Nonfatal injury costs, which differ by severity, were weighted according to the relative incidence of injuries across the Abbreviated Injury Scale (AIS). To determine this incidence, the agency applied a KABCO/MAIS translator to GES KABCO based injury counts from

⁷⁴³ Securing America’s Future Energy, Docket No. NHTSA–2021–0053–1513–A1, at 14–15.

2010 through 2015. This produced the MAIS based injury profile. This profile was used to weight nonfatal injury unit costs derived from Blincoe et al., adjusted to 2018 economics and updated to reflect the official DOT guidance on the value of a statistical life. Property-damaged vehicle costs were also taken from Blincoe et al. and adjusted to 2018 economics. VSL does not affect property damage. This gives societal values of \$10.8 million for each fatality, \$132,000 for each nonfatal injury, and \$7,100 for each property damaged vehicle.

Multiple commenters proposed that we should focus on how the policy alternatives affect fatality rates rather than total fatalities, reflecting concerns that fatalities occurring in incremental travel due to improved fuel economy (*i.e.*, the rebound effect) should not be represented as a safety impact associated with a given change in fuel economy standards.⁷⁴⁴ As discussed above, we agree that consumers who choose to drive more are doing so because they value the benefit of increased driving more than the associated costs. We also agree that effects on the fatality rate is a useful method for assessing a policy change. However, the numerical projection of changes to fatalities is needed for the purpose of conducting a cost-benefit analysis and Circular A–4. As summarized above, we have already acknowledged the differential roles of direct changes in safety (*i.e.*, changes in fatality rates that are independent of the volume of incremental VMT) and changes in safety outcomes (*i.e.*, changes in fatalities influenced by incremental VMT) by offsetting 90 percent of the safety costs associated with rebound VMT.

Walter Kreucher commented broadly on EV battery safety, mentioning vehicle recalls due to battery fire risks and Tesla’s BEV fire mitigation guidelines.⁷⁴⁵ Mr. Kreucher did not address whether he felt this was an issue that warranted inclusion in our analysis, nor did he offer any empirical research concerning the potential fire risk of BEVs. Conversely, Tesla commented that BEVs are safer than their ICE counterparts and will improve safety because of “[t]he basic characteristics of EV design, including small or no motors in front, large crush space for energy absorption, lack of combustible fuel, and low centered

⁷⁴⁴ Office of the California Attorney General, et al., Docket No. NHTSA–2021–0053–1499, at 2–3; CBD et al., Docket No. NHTSA–2021–0053–1572, at 3.

⁷⁴⁵ Walter Kreucher, Docket No. NHTSA–2021–0053–0015, at 9.

batteries that result in extremely low center of gravity and nearly perfect weight distribution.”⁷⁴⁶ Tesla did not provide any empirical or engineering research to support its claim.

While it may be true that the safety risks associated with BEVs and ICE vehicles are *different*, at this point we lack empirical evidence in the record that one technology is *safer*. Furthermore, there is an insufficient sample size of crashes involving BEVs in our database to identify differences in safety effects. As such, we treat the different powertrain technologies equally for the purposes of CAFE. We recognize that commenters’ concerns are relevant and note that NHTSA is establishing a Battery Safety Initiative.⁷⁴⁷ This effort will continue to

⁷⁴⁶ Tesla, Docket No. NHTSA–2021–0053–1480–A1, at 10.

⁷⁴⁷ <https://www.nhtsa.gov/battery-safety-initiative#research>.

collect and analyze data, perform research, develop standards and guidelines, and work with other Federal partners to investigate and understand causes of fire due to safety defect. NHTSA is conducting research on high-voltage battery safety, including expanded research into battery prognostics and diagnostics systems that can detect issues before fires begin. At the same time, NHTSA is working closely with industry, EMS groups, and other government agencies to enhance battery safety during a crash and develop best practices for emergency responders.

6. Impacts of the Final Standards on Safety

Table III–40 through Table III–42 summarize the projected impacts of the standards on safety broken down by factor. These impacts are summarized over the lifetimes of MY 1981 through 2029 vehicles for all light passenger

vehicles (including passenger cars and light trucks). Economic impacts are shown separately under both 3 and 7 percent discount rates. Model years 1981 through 2029 were examined because they represent the model years that might be affected by shifts in fleet composition due to the impact of higher new vehicle prices on sales of new vehicles and retention of older vehicles. Earlier years will be affected by slower scrappage rates and we expect the impacts of these standards will be fully realized in vehicle designs by MY 2029. We note again that the results described below for mass changes are based on a statistical analysis of the relationship between changes in mass and safety that could not be estimated with sufficient precision to distinguish it from zero at standard confidence levels used in the scientific literature. As such, the fatality numbers presented below could in reality be zero, or negative.

BILLING CODE 4910–59–P

Table III-40 – Change in Safety Parameters from Alternative 0 (Baseline) for MY 1981-2029 for Total Fleet, 3 Percent Discount Rate, by Alternative

Alternative	1	2	2.5	3
Fatalities				
Fatalities From Mass Changes	72	95	95	134
Fatalities from Rebound Effect	360	561	620	758
Fatalities from Sales/Scrappage	245	548	620	812
Total Changes in Fatalities	677	1,204	1,335	1,704
Fatality Costs (\$b)				
Fatality Costs From Mass Changes	0.5	0.7	0.7	0.9
Fatality Costs From Rebound Effect	2.4	3.8	4.2	5.1
Fatality Costs from Sales/Scrappage	2.1	4.7	5.4	7.1
Total - Fatality Costs (\$b)	4.9	9.1	10.2	13.1
Non-Fatal Crash Costs (\$b)				
Non-Fatal Crash Costs From Mass Changes	0.6	0.7	0.7	1.1
Non-Fatal Crash Costs From Rebound Effect	2.6	4.2	4.6	5.6
Non-Fatal Crash Costs from Sales/Scrappage	0.6	1.4	1.6	2.0
Total - Non-Fatal Crash Costs (\$b)	3.8	6.3	6.9	8.7
Property Damage Costs (\$b)				
Property Damage Costs From Mass Changes	0.1	0.2	0.2	0.2
Property Damage Costs From Rebound Effect	0.5	0.9	1.0	1.2
Property Damage Costs From Sales/Scrappage	0.1	0.2	0.3	0.3
Total - Property Damage Costs (\$b)	0.8	1.2	1.4	1.7
Societal Crash Costs (\$b)				
Crash Costs from Mass Changes	1.2	1.5	1.5	2.2
Crash Costs from Rebound Effect	5.5	8.8	9.7	11.9
Crash Costs from Sales/Scrappage	2.8	6.3	7.2	9.5
Total - Societal Crash Costs (\$b)	9.5	16.7	18.5	23.5

Table III-41 – Change in Safety Parameters from Alternative 0 (Baseline) for MY 1981-2029 for Total Fleet, 7 Percent Discount Rate, by Alternative

Alternative	1	2	2.5	3
Fatalities				
Fatalities From Mass Changes	72	95	95	134
Fatalities from Rebound Effect	360	561	620	758
Fatalities from Sales/Scrappage	245	548	620	812
Total Changes in Fatalities	677	1,204	1,335	1,704
Fatality Costs (\$b)				
Fatality Costs From Mass Changes	0.3	0.4	0.4	0.5
Fatality Costs From Rebound Effect	1.4	2.2	2.4	2.9
Fatality Costs from Sales/Scrappage	1.5	3.5	4.0	5.4
Total - Fatality Costs (\$b)	3.2	6.1	6.8	8.8
Non-Fatal Crash Costs (\$b)				
Non-Fatal Crash Costs From Mass Changes	0.4	0.5	0.5	0.7
Non-Fatal Crash Costs From Rebound Effect	1.6	2.6	2.9	3.5
Non-Fatal Crash Costs from Sales/Scrappage	0.5	1.1	1.3	1.7
Total - Non-Fatal Crash Costs (\$b)	2.5	4.2	4.6	5.9
Property Damage Costs (\$b)				
Property Damage Costs From Mass Changes	0.1	0.1	0.1	0.1
Property Damage Costs From Rebound Effect	0.3	0.5	0.6	0.7
Property Damage Costs From Sales/Scrappage	0.1	0.2	0.2	0.3
Total - Property Damage Costs (\$b)	0.5	0.8	0.9	1.2
Societal Crash Costs (\$b)				
Crash Costs from Mass Changes	0.7	1.0	1.0	1.4
Crash Costs from Rebound Effect	3.3	5.3	5.9	7.2
Crash Costs from Sales/Scrappage	2.1	4.8	5.5	7.3
Total - Societal Crash Costs (\$b)	6.1	11.1	12.4	15.9

Table III-42 – Change in Non-Fatal Safety Parameters from Alternative 0 (Baseline) for MY 1981-2029 for Total Fleet, by Alternative

Alternative	1	2	2.5	3
Non-Fatal Injuries				
Non-Fatal Injuries From Mass Changes	6,310	8,238	8,234	11,733
Non-Fatal Injuries from Rebound Effect	29,554	46,915	51,936	63,338
Non-Fatal Injuries from Sales/Scrappage	5,455	11,684	12,986	16,206
Total Changes in Non-Fatal Injuries	41,318	66,837	73,156	91,278
Property Damaged Vehicles				
Property Damaged Vehicles From Mass Changes	24,159	31,543	31,530	44,932
Property Damaged Vehicles from Rebound Effect	112,966	179,371	198,576	242,157
Property Damaged Vehicles from Sales/Scrappage	17,287	36,723	40,597	49,865
Total Changes in Property Damaged Vehicles	154,412	247,637	270,704	336,953

As seen in the tables, all three safety factors—changes in mass, fleet turnover, and rebound—increase as the standards become more stringent. As expected, rebound fatalities grow at a constant rate as vehicles become more fuel efficient and are used more frequently. Mass reduction has a relatively minimal impact on safety. This may point to the fleet becoming more homogeneous and hence less mass disparate in crashes, or the use of new materials in vehicle construction. Alternatively, the model may be capturing that there is little room for more mass reductions in particular models. The slowing of fleet turnover due to higher vehicle prices has the largest impact of the three factors on fatalities.

FRIA Chapter 5.6 discusses the results of the analysis in more detail and FRIA Chapter 5.7 provides an overview of sensitivity analyses performed to isolate the uncertainty parameters of each of the three safety impacts.

IV. Regulatory Alternatives Considered in This Final Rule

A. Basis for Alternatives Considered

Agencies typically consider regulatory alternatives as a way of evaluating the comparative effects of different potential ways of accomplishing their desired goal. NEPA requires agencies to compare the potential environmental

impacts of their actions to those of a reasonable range of alternatives. Executive Orders 12866 and 13563, as well as OMB Circular A–4, also request that agencies to evaluate regulatory alternatives in their rulemaking analyses.

Alternatives analysis begins with a “No-Action” Alternative, typically described as what would occur in the absence of any regulatory action. This notice includes a No-Action Alternative, described below, and four “action alternatives.” The new standards may, in places, be referred to as the “Preferred Alternative,” which is NEPA parlance, but NHTSA intends “new standards,” “final standards,” and “Preferred Alternative” to be used interchangeably for purposes of this rulemaking.

Regulations regarding implementation of NEPA require agencies to “rigorously explore and objectively evaluate all reasonable alternatives, and for alternatives which were eliminated from detailed study, briefly discuss the reasons for their having been eliminated.” This does not amount to a requirement that agencies evaluate the widest conceivable spectrum of alternatives. Rather, the range of alternatives must be reasonable and consistent with the purpose and need of the action.

The different regulatory alternatives are defined in terms of percent-increases in CAFE stringency from year to year. Readers should recognize that those year-over-year changes in stringency are not measured in terms of mile per gallon differences (as in, 1 percent more stringent than 30 miles per gallon in one year equals 30.3 miles per gallon in the following year), but rather in terms of shifts in the footprint functions that form the basis for the actual CAFE standards (as in, on a gallon per mile basis, the CAFE standards change by a given percentage from one model year to the next). The rate of change can be the same or different from year to year, and the rate of change can be different for cars and for trucks. For this final rule, NHTSA believes that the alternatives considered here represent a reasonable range of possible final agency actions.

B. Regulatory Alternatives and Final CAFE Standards for MYs 2024–2026

The regulatory alternatives considered by the agency are presented here as the percent-increases-per-year that they represent. The sections that follow will present the alternatives as the literal coefficients which define standards curves increasing at the given percentage rates and will also further explain the basis for the alternatives selected.

Table IV-1 – Regulatory Alternatives Considered in this Final Rule

Regulatory Alternative	Year-Over-Year Stringency Increases (Passenger Cars)			Year-Over-Year Stringency Increases (Light Trucks)		
	2024	2025	2026	2024	2025	2026
Alternative 0 (No Action)	1.5%	1.5%	1.5%	1.5%	1.5%	1.5%
Alternative 1	9.14%	3.26%	3.26%	11.02%	3.26%	3.26%
Alternative 2	8%	8%	8%	8%	8%	8%
Alternative 2.5 (Preferred)	8%	8%	10%	8%	8%	10%
Alternative 3	10%	10%	10%	10%	10%	10%

As for past rulemaking analyses, NHTSA has analyzed each of the regulatory alternatives in a manner that estimates manufacturers’ potential application of technology in response to the corresponding CAFE requirements and the estimated market demand for fuel economy, considering estimated fuel prices, estimated product development cadence, and the estimated availability, applicability,

cost, and effectiveness of fuel-saving technologies. The analysis sometimes shows that specific manufacturers could increase CAFE levels beyond requirements in ways estimated to “pay buyers back” very quickly (*i.e.*, within 30 months) for the corresponding additional costs to purchase new vehicles through avoided fuel outlays. Consistent with the analysis published with the 2020 final rule, this analysis

shows that if battery costs decline as projected while fuel prices increase as projected, BEVs should become increasingly attractive on this basis, such that the modeled application of BEVs (and some other technologies) clearly outstrips regulatory requirements after the mid-2030s.

The analysis accompanying the 2020 final rule presented such results for CAFE standards as well as—

separately—CO₂ standards. New in this rulemaking, DOT has modified the CAFE Model to account for the *combined* effect of both CAFE and CO₂ standards, simulating technology application decisions each manufacturer could possibly make when faced with both CAFE standards and CO₂ standards (and also estimated market demand for fuel economy). This capacity was exercised in order to account for CO₂ standards applicable under the baseline National Program (*i.e.*, the CO₂ standards in place when the current rulemaking was initiated). Also, for this final rule, DOT has further modified the

CAFE Model to account for the “Framework” agreements California has reached with BMW, Ford, Honda, Volkswagen, and Volvo, and for the ZEV mandate that California and the “Section 177” states have adopted. The TSD elaborates on these model capabilities. Generally speaking, the model treats each manufacturer as applying the following logic when making technology decisions:

What do I need to carry over from last year?

What should I apply more widely in order to continue sharing (of, *e.g.*, engines) across different vehicle models?

What new PHEVs or BEVs do I need to build in order to satisfy the ZEV mandates?

What further technology, if any, could I apply that would enable buyers to recoup additional costs within 30 months after buying new vehicles?

What additional technology, if any, should I apply in order to respond to CAFE and CO₂ standards?

All of the regulatory alternatives considered here include, for passenger cars, the following coefficients defining the combination of baseline Federal CO₂ standards and the California Framework Agreements.

Table IV-2 – Passenger Car CO₂ Target Function Coefficients

	2022	2023	2024	2025	2026
<i>a</i> (g/mi)	159	156	154	151	149
<i>b</i> (g/mi)	217	214	210	207	203
<i>c</i> (g/mi per s.f.)	3.88	3.82	3.77	3.71	3.65
<i>d</i> (g/mi)	-0.1	-0.4	-0.6	-0.9	-1.2
<i>e</i> (s.f.)	41	41	41	41	41
<i>f</i> (s.f.)	56	56	56	56	56
<i>g</i> (g/mi)	151	146	140	135	130
<i>h</i> (g/mi)	207	199	192	185	178
<i>i</i> (g/mi per s.f.)	3.70	3.56	3.43	3.30	3.18
<i>j</i> (g/mi)	-0.4	-0.4	-0.4	-0.3	-0.3

Coefficients *a*, *b*, *c*, *d*, *e*, and *f* define the baseline Federal CO₂ standards for passenger cars. Analogous to coefficients defining CAFE standards, coefficients *a* and *b* specify minimum and maximum passenger car CO₂ targets in each model year. Coefficients *c* and *d* specify the slope and intercept of the

linear portion of the CO₂ target function, and coefficients *e* and *f* bound the region within which CO₂ targets are defined by this linear form. Coefficients *g*, *h*, *i*, and *j* define the CO₂ targets applicable to BMW, Ford, Honda, Volkswagen, and Volvo, pursuant to the agreements these manufacturers have

reached with California. Beyond 2026, the MY 2026 Federal standards apply to all manufacturers, including these five manufacturers. The coefficients shown in Table IV-3 define the corresponding CO₂ standards for light trucks.

Table IV-3 – Light Truck CO₂ Target Function Coefficients

	2022	2023	2024	2025	2026
<i>a</i> (g/mi)	203	200	196	193	190
<i>b</i> (g/mi)	324	319	314	309	304
<i>c</i> (g/mi per s.f.)	4.44	4.37	4.31	4.23	4.17
<i>d</i> (g/mi)	20.6	20.2	19.6	19.6	19.0
<i>e</i> (s.f.)	41	41	41	41	41
<i>f</i> (s.f.)	74	74	74	74	74
<i>g</i> (g/mi)	188	181	174	168	162
<i>h</i> (g/mi)	324	312	300	289	278
<i>i</i> (g/mi per s.f.)	4.12	3.97	3.82	3.68	3.54
<i>j</i> (g/mi)	19.1	18.4	17.7	17.0	16.4

All of the regulatory alternatives considered here also include NHTSA's estimates of ways each manufacturer could introduce new PHEVs and BEVs in response to ZEV mandates. As discussed in greater detail below, these

estimates force the model to convert specific vehicle model/configurations to either a BEV200, BEV300, or BEV400 at the earliest estimated redesign. These "ZEV Candidates" define an incremental response to ZEV mandates

(i.e., beyond PHEV and BEV production through MY 2020) comprise the following shares of manufacturers' MY 2020 production for the U.S. market as shown in Table IV-4.

Table IV-4 – ZEV “Candidates” as Share of MY 2020 Production

Manufacturer	BEV200	BEV300	BEV400
BMW		1.9%	
Daimler	2.6%		0.8%
FCA		1.1%	
Ford	0.1%	1.1%	
GM		1.0%	
Honda		1.8%	
Hyundai		1.3%	
Kia	1.7%	0.5%	
Jaguar – Land Rover	0.2%	1.4%	
Mazda	3.1%		
Mitsubishi	0.6%	1.2%	
Nissan		0.5%	
Subaru		2.2%	
Tesla			
Toyota	1.2%	0.7%	
Volvo	2.3%	0.7%	
VWA		1.5%	

BILLING CODE 4910-59-C

For example, while Tesla obviously need not introduce additional BEVs to comply with ZEV mandates, our analysis indicates Nissan could need to increase BEV offerings modestly to do so, and Mazda and some other manufacturers may need to do considerably more than Nissan to introduce new BEV offerings.

This representation of CO₂ standards and ZEV mandates applies equally to all regulatory alternatives, and NHTSA's analysis applies the CAFE Model to examine each alternative treating each manufacturer as responding jointly to the entire set of requirements. This is distinct from model application of BEVs for compliance purposes under the compliance simulations of the different action alternatives which inform decision-makers regarding potential effects of the standards.

Chapter 1 of the TSD contains extensive discussion of the development of the No-Action Alternative and explains the reasons for and effect of apparent "over-compliance" with the No-Action Alternative, which reduces

costs and benefits attributable to the new CAFE standards and other action alternatives. In the proposal preceding this document, NHTSA sought comment broadly on its approach to developing the No-Action Alternative for the final rule, and also specifically sought comment on whether and how to add to the No-Action Alternative for the final rule an estimation of GHG standards that California and the Section 177 states might separately enforce if California's waiver of CAA preemption was re-established.

Comments were mixed regarding whether commenters agreed that it was appropriate for NHTSA to account for State ZEV standards as part of the No-Action Alternative, with state and local government commenters,⁷⁴⁸ electric vehicle manufacturers,⁷⁴⁹ and

alternative-fueled vehicle organizations⁷⁵⁰ supporting their inclusion, and other automaker commenters,⁷⁵¹ NADA,⁷⁵² AVE,⁷⁵³ and Mr. Kreucher⁷⁵⁴ opposing their inclusion. NCAT, for example, stated that "[i]t would be an absurd interpretation of EPCA to find that the agency should create a fictional baseline that does not reflect the alternative fuel vehicles that are already being sold and those that will be required to be sold under ZEV mandates and GHG emissions standards in the future, in particular as alternative fuel vehicles are an increasingly substantial part of the U.S. market."⁷⁵⁵ NCAT argued that

⁷⁵⁰ NCAT, Docket No. NHTSA-2021-0053-1508, at 2, 6-7.

⁷⁵¹ Auto Innovators, Docket No. NHTSA-2021-0053-1492, at 45-46; Stellantis, Docket No. NHTSA-2021-0053-1527, at 12; Kia, Docket No. NHTSA-2021-0053-1525, at 2.

⁷⁵² NADA, Docket No. NHTSA-2021-0053-1471, at 4-5.

⁷⁵³ AVE, Docket No. NHTSA-2021-0053-1488-A1, at 5.

⁷⁵⁴ Walt Kreucher, Docket No. NHTSA-2021-0053-0013, at 3.

⁷⁵⁵ NCAT, at 2.

⁷⁴⁸ California Attorney General et al., Docket No. NHTSA-2021-0053-1499, at 3; CARB, Docket No. NHTSA-2021-0053-1521, at 9; South Coast AQMD, Docket No. NHTSA-2021-0053-1477, at 2.

⁷⁴⁹ Lucid, Docket No. NHTSA-2021-0053-1584, at 5; Rivian, Docket No. NHTSA-2021-0053-1562, at 2; Tesla, Docket No. NHTSA-2021-0053-1480-A1, at 8.

there was no conflict between the statutory prohibition in 49 U.S.C. 32902(h) on considering the fuel economy of dedicated alternative fueled vehicles and the statutory requirement in 49 U.S.C. 32902(f) to consider “other motor vehicle standards of the Government,” because “ZEV mandates or vehicle GHG emissions standards . . . do not involve consideration of ‘fuel economy . . .’”⁷⁵⁶ NCAT went so far as to argue that NHTSA had overstated costs for all of the regulatory alternatives by not including *more* ZEV penetration in its baseline.⁷⁵⁷ CARB, California Attorney General et al., and South Coast Air Quality Management District (South Coast (South Coast AQMD) all agreed that if EPA reinstated the waiver for California’s programs prior to NHTSA finalizing these standards, then including those standards in the baseline would be reasonable. As California Attorney General et al. put it, “It is plainly reasonable for an agency to include the preexisting legal obligations of regulated parties in No Action baselines, since these baselines aim to capture, as accurately as possible, how regulated parties would behave but for the regulatory changes under consideration.”⁷⁵⁸ Rivian urged NHTSA to expand its analysis by including Minnesota, Nevada, and Virginia as additional “Section 177” states.⁷⁵⁹ Commenters opposing NHTSA’s inclusion of the ZEV program in the baseline generally argued that it was contrary to the prohibition in 49 U.S.C. 32902(h) against considering the fuel economy of dedicated alternative fueled vehicles in determining maximum feasible standards.

NHTSA has kept the ZEV program in the No-Action Alternative for the analysis supporting this final rule. We disagree with comments from Auto Innovators and others that 32902(h) prohibits inclusion of ZEVs in the analytical baseline. Section 32902(h) states that in *setting standards*, including “[w]hen deciding maximum feasible fuel economy,” NHTSA “may not consider the fuel economy of dedicated automobiles.” The baseline is supposed to reflect the world in the absence of further CAFE standards. The baseline is not itself the decision on what standards are maximum feasible. Auto Innovators also commented that if NHTSA relied on the “other motor vehicle standards of the Government” factor as a basis for accounting for ZEV

programs in its analytical baseline, that would violate the statutory construction rule of *generalia specialibus non derogant* (generally, a specific statutory provision prevails over a more general one, if in conflict). NHTSA is not relying on the “other motor vehicle standards of the Government” factor as a basis for accounting for ZEV programs in the baseline. Rather, NHTSA is including other relevant legal requirements that automakers will meet during the regulatory timeframe in order to reflect the state of the world without the CAFE standards. Unless the baseline accurately reflects the world without the CAFE standards, the regulatory analysis will not identify the effects of the CAFE standards. It is perfectly possible to give meaningful effect⁷⁶⁰ to the 49 U.S.C. 32902(h) prohibition by not allowing the CAFE Model to rely on ZEV (or other dedicated alternative fuel) technology during the rulemaking time frame, while still acknowledging the clear reality that the state ZEV programs exist, and manufacturers are complying with them, just like the agency acknowledges that electric vehicles exist in the fleet independent of the ZEV program. EPA issued a notice to reconsider its SAFE 1 (SAFE 1 rule; 84 FR 51310, Sept. 27, 2019) actions that included the waiver withdrawal of California’s ZEV sales mandate and greenhouse gas emission standards in April 2021.⁷⁶¹ EPA has since published its final decision regarding the reconsideration of its SAFE 1 actions with the result that the waiver issued in 2013 for the ZEV sales mandate and greenhouse gas emission standards is back in force.⁷⁶² NHTSA withdrew its SAFE 1 rule on December 29, 2021.⁷⁶³ California, and the Section 177 states (subject to the criteria in Section 177), are free to enforce the ZEV mandate, and manufacturers are building ZEVs in response to it. These standards are real and would be in force whether or not NHTSA increased the stringency of the CAFE standards. By accounting for them in the baseline, NHTSA acknowledges this reality; by withholding ZEV technology as a model option during the rulemaking timeframe, NHTSA respects the 49 U.S.C. 32902(h) prohibition. This is how we give effect to Section 32902(h). NHTSA agrees with NCAT

⁷⁶⁰ The reason that NHTSA knows this effect is meaningful is because compliance with all regulatory alternatives is more cost-effective under the “unconstrained” or “EIS” model runs, in which NHTSA allows the model to build BEVs, than under the “standard-setting” runs, in which NHTSA implements the 32902(h) restrictions.

⁷⁶¹ 86 FR 22421 (Apr. 28, 2021).

⁷⁶² 87 FR 14332 (Mar. 14, 2022).

⁷⁶³ 86 FR 74236 (Dec. 29, 2021).

that it would be an absurd result to build a fictional baseline that pretended as though these standards, and the vehicles produced in response to them, were not real. Agency decision-makers would not be well-informed as to the consequences of different regulatory actions with a baseline that ignored these non-NHTSA standards.

Nor does NHTSA agree that reflecting ZEV mandates in the baseline somehow “thwarts Congress’ intent” in providing compliance boosts for dedicated and dual-fueled alternative fuel vehicles. ZEVs produced in response to ZEV mandates are not produced to comply *with CAFE standards*, even if they improve manufacturers’ compliance with CAFE standards, because those vehicles are going to be produced anyway to comply *with the ZEV mandates*. Manufacturers get the full compliance benefit of these vehicles in the CAFE program.

It thus seems both reasonable and preferable to try to give meaningful effect to Section 32902(h), while meaningfully informing decision-makers about the effects of their decision. We also note that in the sensitivity analyses for this final rule, NHTSA ran a case in which ZEV compliance was *not* reflected in the baseline. As documented in the FRIA, not accounting for ZEV mandates would have increased estimated incremental benefits and costs attributable to new CAFE standards by about 3 percent.⁷⁶⁴ Chapter 7 of the FRIA discusses this finding in more detail. These small differences were not dispositive for NHTSA in choosing the Preferred Alternative; nor would removing ZEV from the baseline in the main analysis have led NHTSA to reach a different conclusion regarding maximum feasible CAFE standards.

Some commenters also addressed NHTSA’s question of whether to include state GHG standards in the baseline. Arguments for and against including state GHG standards in the baseline were fairly similar to those regarding ZEV mandates. Tesla, however, argued that because “California and the Section 177 states have written the GHG standards into their EPA approved SIPs,” . . . “these more stringent standards have remained in place and [are] enforceable while the waiver gets reinstated because EPA never compelled any of these SIPs to be

⁷⁶⁴ While Rivian encouraged NHTSA to add Minnesota, Nevada, and Virginia to the list of ZEV states, NHTSA believes that accounting for these States’ recent adoption of ZEV mandates would only have slightly impacted the 3 percent difference, and also would not have impacted NHTSA’s conclusions.

⁷⁵⁶ *Id.*

⁷⁵⁷ *Id.*, at 8.

⁷⁵⁸ California State Attorney General et al., at 3.

⁷⁵⁹ Rivian, at 2.

amended or revised to remove the purportedly preempted standards.”⁷⁶⁵

As explained in the NPRM, NHTSA does not currently have the capability to model a sub-national fleet concurrently with a national fleet and remains concerned about potentially important differences between the Section 177 states that would complicate finding a workable approach to doing so. NHTSA thus has not reflected the state GHG standards in this final rule analysis, despite Tesla’s recommendation. That said, noting that all of the vehicles that manufacturers ultimately sell in these States will be among those vehicles that manufacturers produce for sale in the United States, NHTSA anticipates that if California and other States enforce requirements regarding the average CO₂ performance of vehicles sold in these States, and NHTSA concurrently enforces requirements regarding the average fuel economy levels of vehicles produced for sales nationwide, manufacturers will be able to meet the State-level requirements by selling different proportions of vehicles in states with GHG requirements than in states that lack them. Manufacturers could sell a higher proportion of vehicles (such as the BEVs and PHEVs some of these States also encourage through ZEV mandates) with CO₂ levels well below corresponding CO₂ targets in these States than in the rest of the country, and by selling a smaller proportion of vehicles (such as some performance and luxury models, and some sport-utility vehicles) that perform especially poorly relative to CO₂ targets.⁷⁶⁶

A few commenters addressed NHTSA’s inclusion in the baseline of the California Framework Agreements with BMW, Ford, Honda, Volkswagen, and Volvo, binding those companies to more stringent GHG standards than the

2020 final rule would have required. Rivian⁷⁶⁷ and NCAT agreed that including the Framework Agreements was appropriate. For example, NCAT commented that it was reasonable to consider the Framework Agreements, because the five manufacturers involved represent a significant portion of the market, and the agreements are contractual.⁷⁶⁸ NADA argued, in contrast, that “The OEMs that entered those agreements represent only about a third of U.S. vehicle sales,” and that “their actions should not be incorporated into the baseline for any revised CAFE standards with which all OEMs must comply,” because “That OEMs representing the other two-thirds of U.S. vehicle sales did not enter similar agreements is telling and raises significant questions as to whether the ‘framework’ standards are reasonable and appropriate.”⁷⁶⁹

In response, NHTSA reiterates that the purpose of a baseline is to reflect the world in the absence of further regulatory action by NHTSA, so that NHTSA can then attempt to evaluate the effects of taking different regulatory actions. Only the Framework-Agreement manufacturers were reflected in the baseline, not the fleet as a whole. Because those agreements were contractual, NHTSA found it reasonable to assume that automakers would meet their terms and that this approach would best reflect the state of the world in the absence of further regulatory action by NHTSA, and therefore included them in the baseline for this analysis. NADA’s comment more likely pertains to the feasibility of standards that would require similar (or higher) levels of fuel economy improvement from all manufacturers. The feasibility of different alternatives will be discussed in Section VI of this preamble.

Other commenters indicated that NHTSA should, in effect, assume that manufacturers would never increase CAFE beyond levels required by CAFE

standards, *i.e.*, that there is no real-world market-driven increase in fuel economy (regardless of fuel price) that could or should be reflected in NHTSA’s analysis.⁷⁷⁰ NHTSA has carefully considered these comments, and finds that the comments conflict with the historical record showing manufacturers sometimes achieving CAFE levels beyond those required by CAFE standards. Historical record aside, NHTSA recognizes that future fuel prices cannot be predicted with certainty yet will almost certainly impact manufacturers’ and buyers’ future decisions. The aforementioned comments imply an approach that would not respond at all to fuel prices, such that manufacturers’ estimated application of technology would be the same if gasoline costs more than \$7 per gallon as if gasoline costs less than \$2 per gallon. Under NHTSA’s analytical approach, fuel economy increases beyond requirements grow as fuel prices increase, and the sensitivity analysis documented in the FRIA accompanying this document suggests that to ignore this response would have led NHTSA to overstate significantly the incremental benefits and costs of new CAFE standards. Commenters have provided no basis for predicting with confidence how manufacturers and buyers will act in the future, or any logical basis to assume that fuel prices will not impact their decisions. NHTSA maintains that fuel prices are almost certain to play a role, and that it remains reasonable to NHTSA to assume that having met fuel economy requirements, manufacturers may apply additional fuel-saving technologies that pay back within the first 30 months of vehicle ownership.

1. No-Action Alternative

The No-Action Alternative (also referred to as “Alternative 0”) applies the CAFE target curves set in 2020 for MYs 2024–2026, which raised stringency by 1.5 percent per year for both passenger cars and light trucks.

BILLING CODE 4910–59–P

⁷⁷⁰ See, *e.g.*, UCS, Docket No. NHTSA–2021–0053–1567, at 25–29.

⁷⁶⁵ Tesla, at 8.

⁷⁶⁶ Examples of such vehicles can be identified in the published vehicle-level model results (in the archive posted at <https://www.nhtsa.gov/corporate-average-fuel-economy/cape-compliance-and-effects-modeling-system>) (accessed: March 15, 2022) by comparing “CO₂ Rated” and “CO₂ Target” values for specific vehicle model/configurations.

⁷⁶⁷ Rivian, at 2.

⁷⁶⁸ NCAT, at 7–8.

⁷⁶⁹ NADA, at 4–5.

Table IV-5 – Characteristics of No-Action Alternative – Passenger Cars

	2024	2025	2026
<i>a (mpg)</i>	51.78	52.57	53.37
<i>b (mpg)</i>	38.74	39.33	39.93
<i>c (gpm per s.f.)</i>	0.000433	0.000427	0.000420
<i>d (gpm)</i>	0.00155	0.00152	0.00150

Table IV-6 – Characteristics of No-Action Alternative – Light Trucks

	2024	2025	2026
<i>a (mpg)</i>	41.55	42.18	42.82
<i>b (mpg)</i>	26.82	27.23	27.64
<i>c (gpm per s.f.)</i>	0.000484	0.000477	0.000469
<i>d (gpm)</i>	0.00423	0.00417	0.00410

These equations are presented graphically in Figure IV-1 and Figure IV-2, where the x-axis represents

vehicle footprint and the y-axis represents fuel economy, showing that in “CAFE space,” targets are higher in

fuel economy for smaller footprint vehicles and lower for larger footprint vehicles.

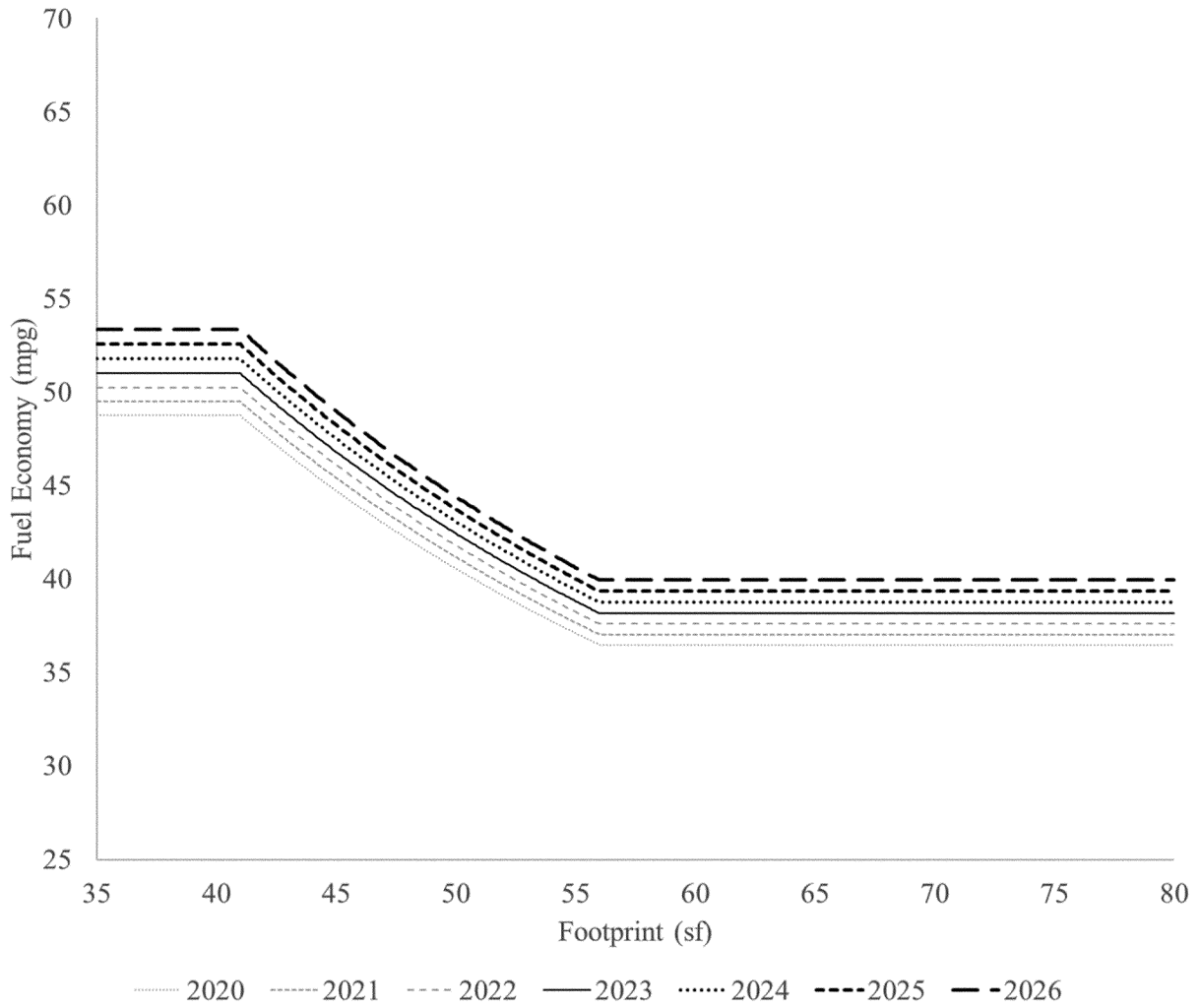

Figure IV-1 – No-Action Alternative, Passenger Car Fuel Economy Target Curves

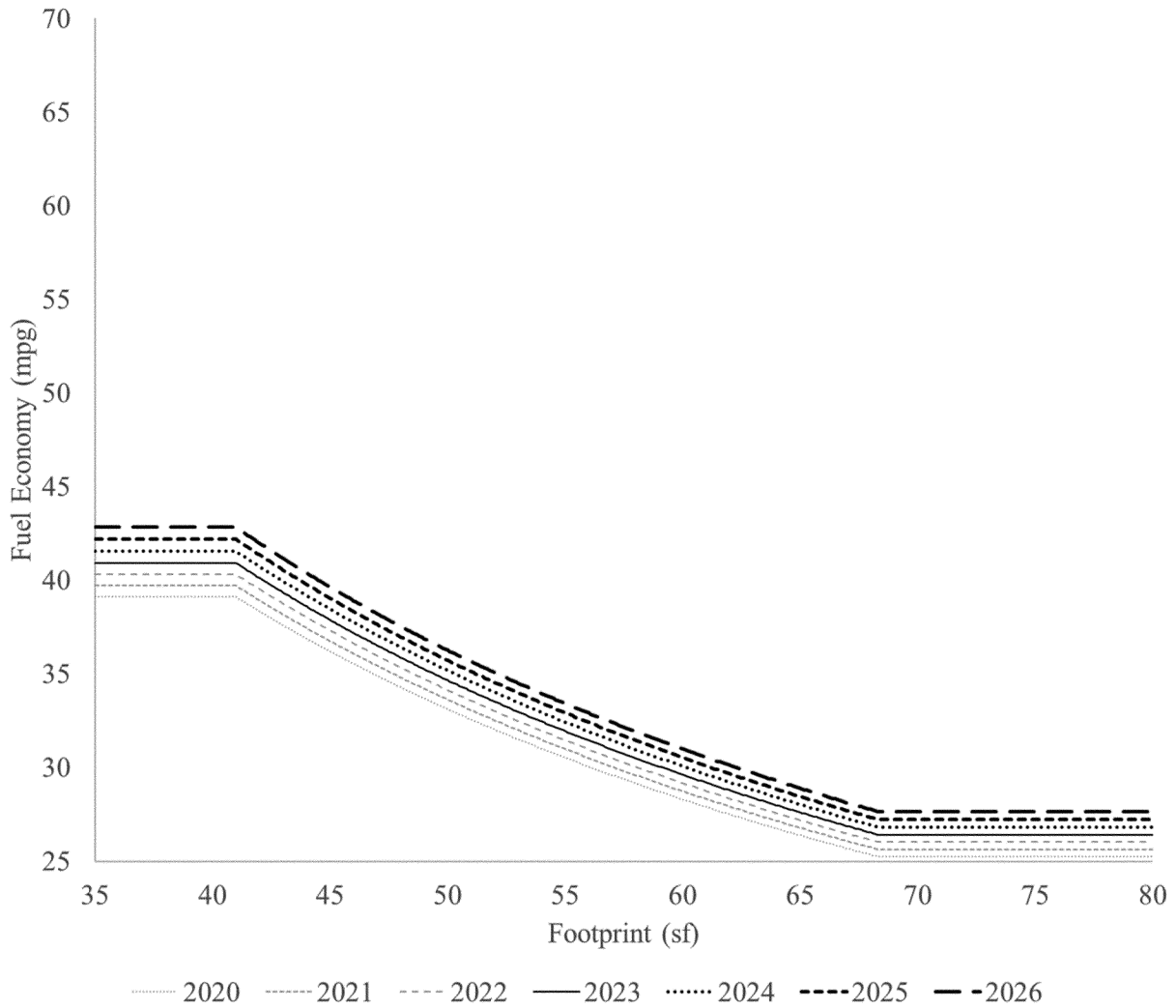

Figure IV-2 – No-Action Alternative, Light Truck Fuel Economy Target Curves

NHTSA must also set a minimum standard for domestically manufactured passenger cars, which is often referred to as the “MDPCS.” Any time NHTSA

establishes or changes a passenger car standard for a model year, the MDPCS must also be evaluated or re-evaluated and established accordingly, but for

purposes of the No-Action Alternative, the MDPCS is as it was established in the 2020 final rule, as shown in Table IV-7.

Table IV-7 – No-Action Alternative - Minimum Domestic Passenger Car Standard

2024	2025	2026
41.8 mpg	42.4 mpg	43.1 mpg

As the baseline against which the Action Alternatives are measured, the No-Action Alternative includes several policies and agreements already in effect as well as manufacturer choices that NHTSA believes will occur absent the revised CAFE standards. First, as discussed extensively above, NHTSA has included California’s ZEV mandate as part of the No-Action Alternative. Second, NHTSA has included the agreements made between California

and BMW, Ford, Honda, VWA, and Volvo, because these agreements by their terms are contracts, even though they were entered into voluntarily.⁷⁷¹ NHTSA did so by including EPA’s baseline (*i.e.*, 2020) GHG standards in its analysis, and then introducing more stringent GHG target functions during MYs 2022–2026 consistent with those

⁷⁷¹ See <https://ww2.arb.ca.gov/news/framework-agreements-clean-cars>.

agreements, but treating only these five manufacturers as subject to these more stringent target functions. As in past analyses, NHTSA’s analysis further assumes that, beyond any technology applied in response to CAFE standards, EPA GHG standards, California/OEM agreements, and ZEV mandates applicable in California and the Section 177 states, manufacturers will also make any additional fuel economy improvements estimated to reduce

owners' estimated average fuel outlays during the first 30 months of vehicle operation by more than the estimated increase in new vehicle price.

NHTSA accomplished much of this through expansion of the CAFE Model after the prior rulemaking. The previous version of the model had been extended to apply to GHG standards as well as CAFE standards but had not been published in a form that simulated simultaneous compliance with both sets of standards. As discussed at greater length in the current CAFE Model documentation, the updated version of the model simulates all the following simultaneously:

- Compliance with CAFE standards
- Compliance with GHG standards applicable to all manufacturers
- Compliance with alternative GHG standards applicable to a subset of manufacturers
- Compliance with ZEV mandates
- Further fuel economy improvements applied if sufficiently cost-effective for buyers

As explained in the NPRM, the impacts of all the alternatives evaluated here are against the backdrop of these other obligations applicable to and voluntary actions taken by automakers. This is important to remember, because it means that automakers will be taking

actions to comply with these other obligations or voluntarily that will at times affect fuel economy even in the absence of new CAFE standards, and that costs and benefits attributable to those actions are therefore *not* attributable to CAFE standards.

2. Alternative 1

Alternative 1 would increase CAFE stringency for MY 2024 by 9.14 percent for passenger cars and 11.02 percent for light trucks and increase stringency in MYs 2025 and 2026 by 3.26 percent per year for both passenger cars and light trucks.⁷⁷²

Table IV-8 – Characteristics of Alternative 1 – Passenger Cars

	2024	2025	2026
<i>a (mpg)</i>	56.15	58.04	60.00
<i>b (mpg)</i>	42.00	43.41	44.88
<i>c (gpm per s.f.)</i>	0.000400	0.000387	0.000374
<i>d (gpm)</i>	0.00141	0.00136	0.00132

Table IV-9 – Characteristics of Alternative 1 – Light Trucks⁷⁷³

	2024	2025	2026
<i>a (mpg)</i>	46.17	47.73	49.34
<i>b (mpg)</i>	27.73	28.67	29.63
<i>c (gpm per s.f.)</i>	0.000436	0.000422	0.000408
<i>d (gpm)</i>	0.00377	0.00365	0.00353

These equations are represented graphically in Figure IV-3 and Figure IV-4.

⁷⁷² Increases of MY 2024 stringencies as compared to MY 2023 are based on computed averages of manufacturers' required CAFE levels. Increases of MYs 2025 and 2026 stringencies are based on mathematical progression of coefficients defining applicable fuel economy targets.

⁷⁷³ For this and other action alternatives, readers may note that the cutpoint for large trucks is further to the right than in the 2020 final rule. The 2020 final rule (and its preceding NPRM) did not contain an adjustment to the right cutpoint that had been finalized in 2012. Because comments were not received to the NPRM, the lack of adjustment was

finalized. Considering the question again for this action, NHTSA believes that moving the cutpoint to the right for large trucks (consistent with the intent and requirements in 2012) is reasonable, given the rate of increase in stringency for this action. NHTSA did not receive any comments addressing this change.

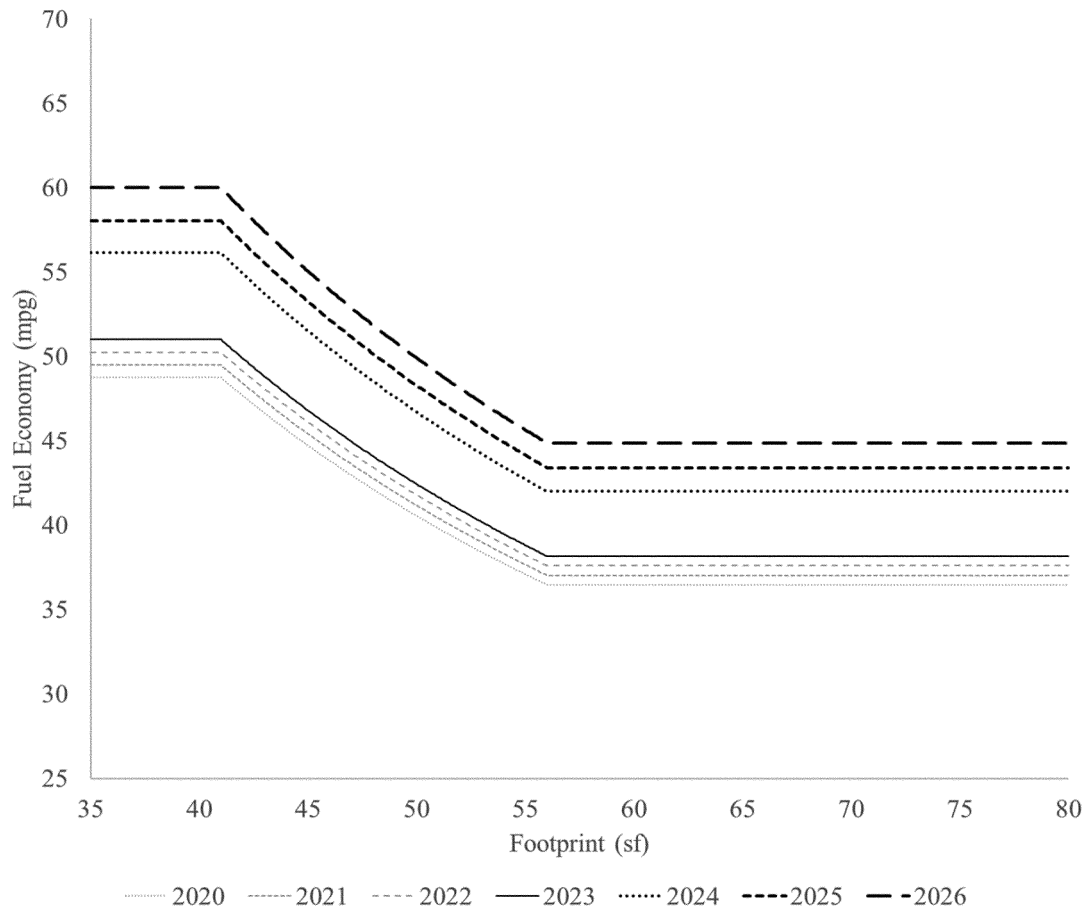

Figure IV-3 – Alternative 1, Passenger Car Fuel Economy, Target Curves

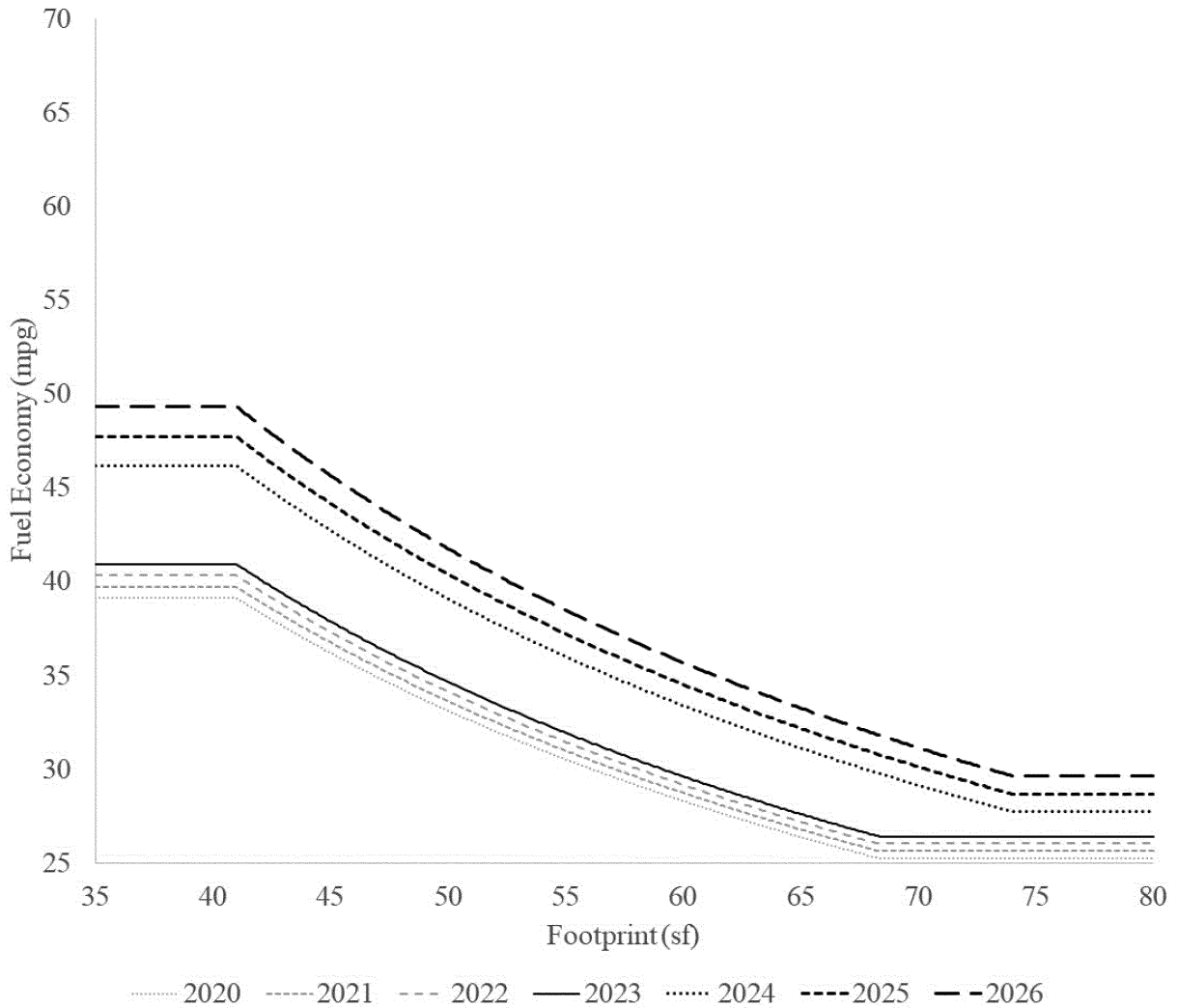

Figure IV-4 – Alternative 1, Light Truck Fuel Economy, Target Curves

Under this alternative, the MDPCS is as shown in Table IV-10.

Table IV-10 – Alternative 1 - Minimum Domestic Passenger Car Standard

2024	2025	2026
44.9 mpg	46.4 mpg	48.0 mpg

3. Alternative 2

Alternative 2 would increase CAFE stringency at 8 percent per year.⁷⁷⁴

⁷⁷⁴ Increases of MY 2024–2026 stringencies are based on mathematical progression of coefficients defining applicable fuel economy targets.

Table IV-11 – Characteristics of Alternative 2 – Passenger Cars

	2024	2025	2026
a (mpg)	55.44	60.26	65.50
b (mpg)	41.48	45.08	49.00
c (gpm per s.f.)	0.000405	0.000372	0.000343
d (gpm)	0.00144	0.00133	0.00122

Table IV-12 – Characteristics of Alternative 2 – Light Trucks

	2024	2025	2026
<i>a (mpg)</i>	44.48	48.35	52.56
<i>b (mpg)</i>	26.74	29.07	31.60
<i>c (gpm per s.f.)</i>	0.000452	0.000416	0.000382
<i>d (gpm)</i>	0.00395	0.00364	0.00334

Under this alternative, the MDPCS is as shown in Table IV-13.

Table IV-13 – Alternative 2 - Minimum Domestic Passenger Car Standard

2024	2025	2026
44.3 mpg	48.2 mpg	52.4 mpg

4. Alternative 2.5

In the proposal preceding this final rule, NHTSA sought comment on a

possible modification to Alternative 2, which would have increased the stringency of CAFE standards by 10 percent between MYs 2025 and 2026,

rather than by 8 percent. Shown graphically, this possibility appeared as shown in Figure IV-5.

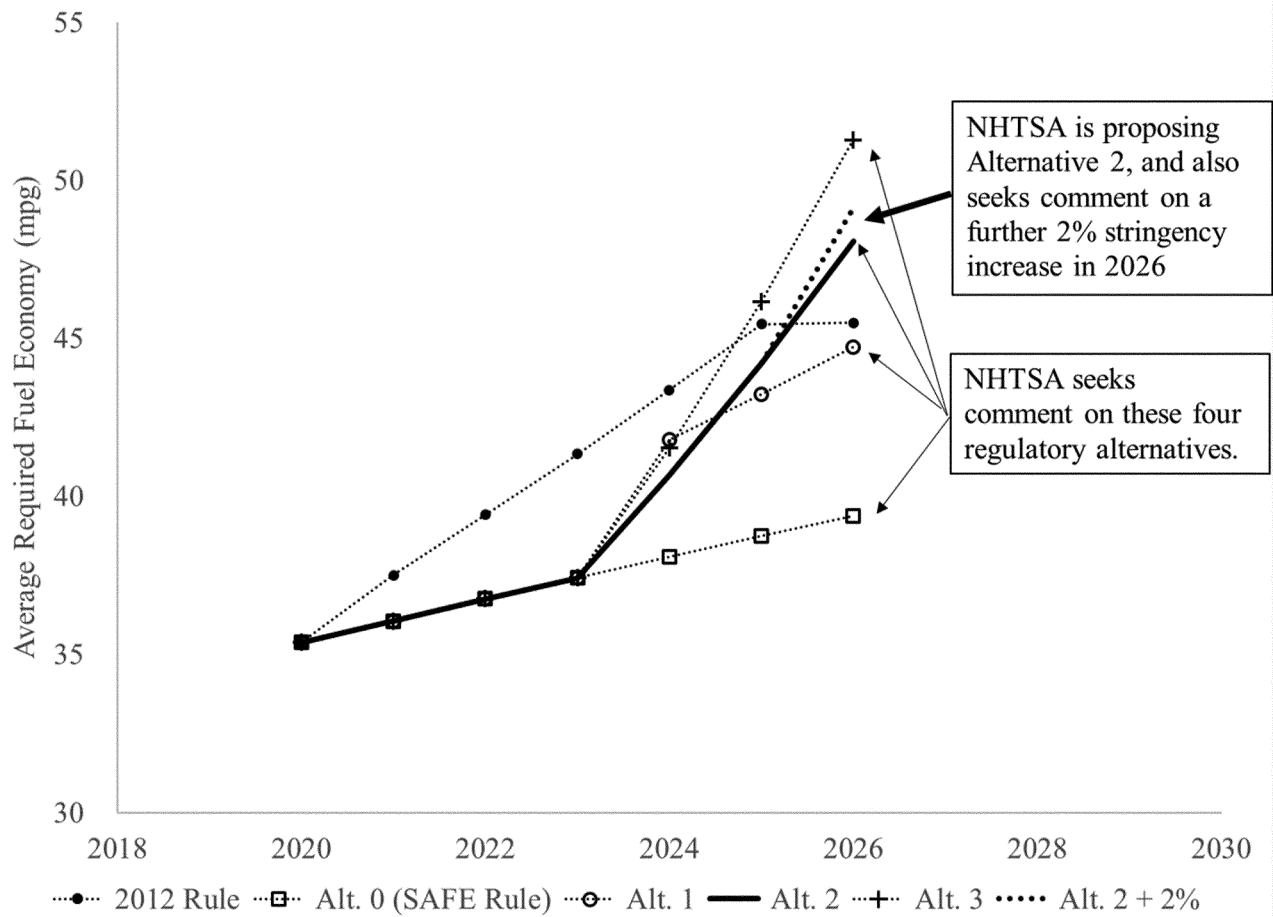

Figure IV-5 – NPRM’s Graphic Representation of Possible Other Alternative

The coefficients associated with this alternative have been determined as follows:

Table IV-14 – Characteristics of Alternative 2.5 – Passenger Cars

	2024	2025	2026
a (mpg)	55.44	60.26	66.95
b (mpg)	41.48	45.08	50.09
c (gpm per s.f.)	0.000405	0.000372	0.000335
d (gpm)	0.00144	0.00133	0.00120

Table IV-15 – Characteristics of Alternative 2.5 – Light Trucks

	2024	2025	2026
a (mpg)	44.48	48.35	53.73
b (mpg)	26.74	29.07	32.30
c (gpm per s.f.)	0.000452	0.000416	0.000374
d (gpm)	0.00395	0.00364	0.00327

These equations are represented graphically in Figure IV-6 and Figure IV-7.

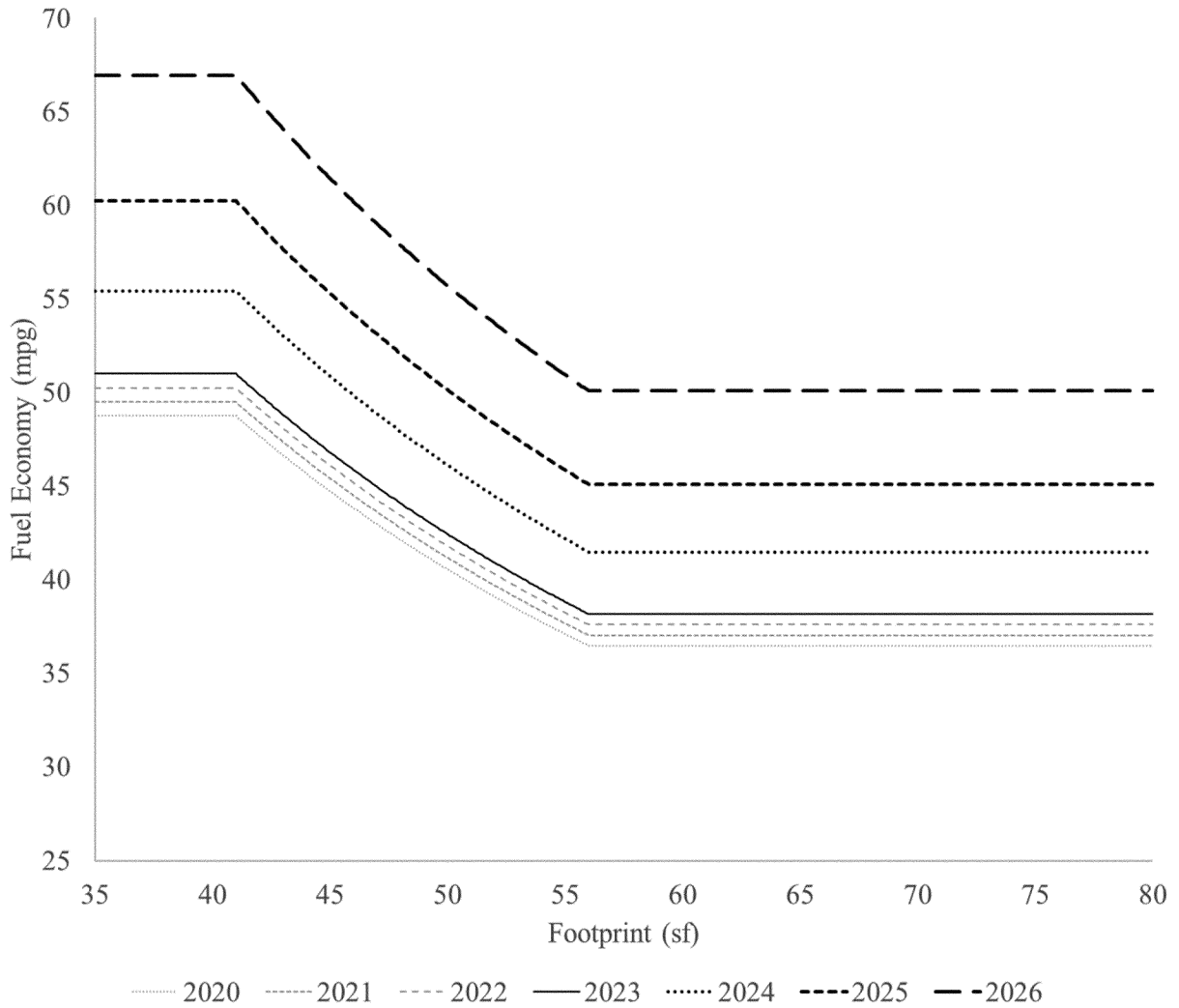

Figure IV-6 – Alternative 2.5, Passenger Car Fuel Economy, Target Curves

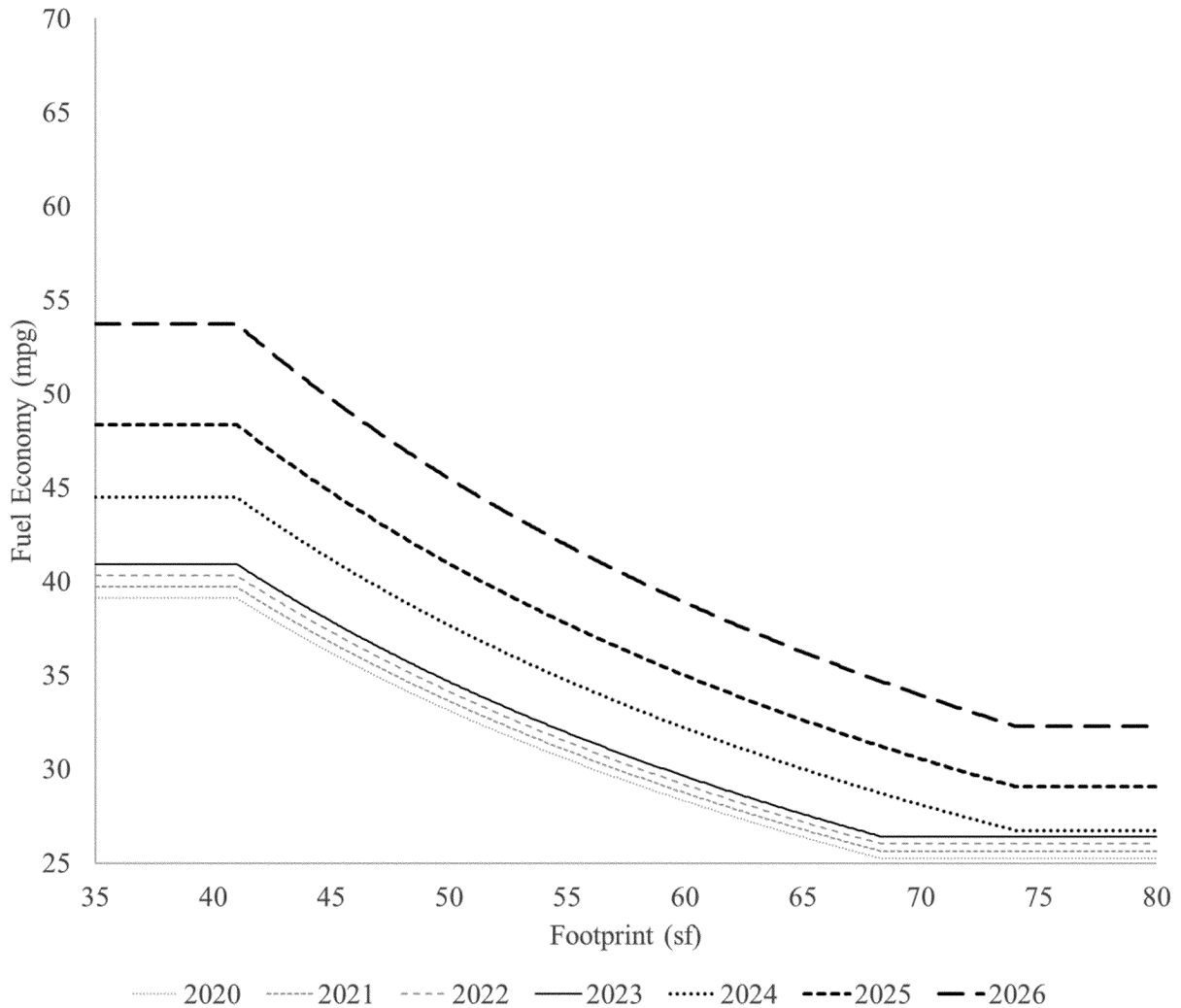

Figure IV-7 – Alternative 2.5, Light Truck Fuel Economy, Target Curves

Under the alternative, the MDPCS is as follows in Table IV-16.

Table IV-16 – Alternative 2.5 – Minimum Domestic Passenger Car Standard

2024	2025	2026
44.3 mpg	48.2 mpg	53.5 mpg

NHTSA considered this alternative as a way to evaluate the effects of CAFE standards that could be considered a middle ground between Alternative 2 and Alternative 3 allowing for a slower ramp in stringency than Alternative 3 but providing additional lead time to return to a fuel consumption trajectory

similar to the standards announced in 2012.

5. Alternative 3

Alternative 3 would increase CAFE stringency at 10 percent per year.⁷⁷⁵ In the NPRM preceding this document, NHTSA calculated that Alternative 3 would result in total lifetime fuel

savings from vehicles produced during MYs 2021–2029 similar to total lifetime fuel savings that would have occurred if NHTSA had promulgated final CAFE standards for MYs 2021–2025 at the augural levels announced in 2012. In addition, Alternative 3 contemplated capturing fuel savings as if NHTSA had

⁷⁷⁵ Increases of MY 2024–2026 stringencies are based on mathematical progression of coefficients defining applicable fuel economy targets.

also promulgated MY 2026 standards that reflected a continuation of that average rate of stringency increase (4.48

percent for passenger cars and 4.54 percent for light trucks).

Table IV-17 – Characteristics of Alternative 3 – Passenger Cars

	2024	2025	2026
a (mpg)	56.67	62.97	69.96
b (mpg)	42.40	47.11	52.34
c (gpm per s.f.)	0.0003 96	0.000356	0.000321
d (gpm)	0.0014 1	0.00127	0.00114

Table IV-18 – Characteristics of Alternative 3 – Light Trucks

	2024	2025	2026
a (mpg)	45.47	50.53	56.14
b (mpg)	27.34	30.38	33.75
c (gpm per s.f.)	0.000442	0.000398	0.000358
d (gpm)	0.00387	0.00348	0.00313

These equations are represented graphically in Figure IV-8 and Figure

IV-9. For this final rule, NHTSA retained this definition of Alternative 3.

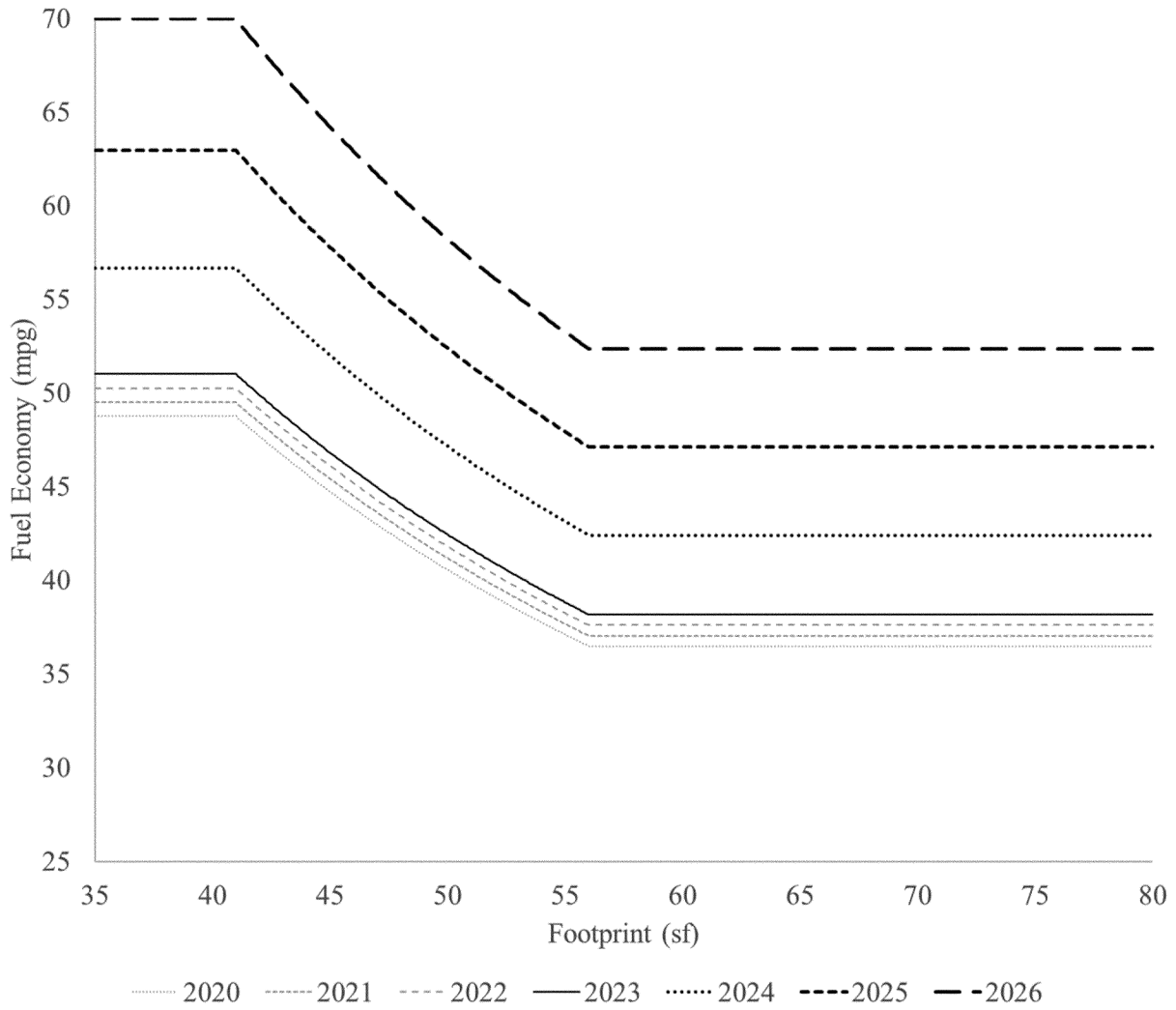

Figure IV-8 – Alternative 3, Passenger Car Fuel Economy, Target Curves

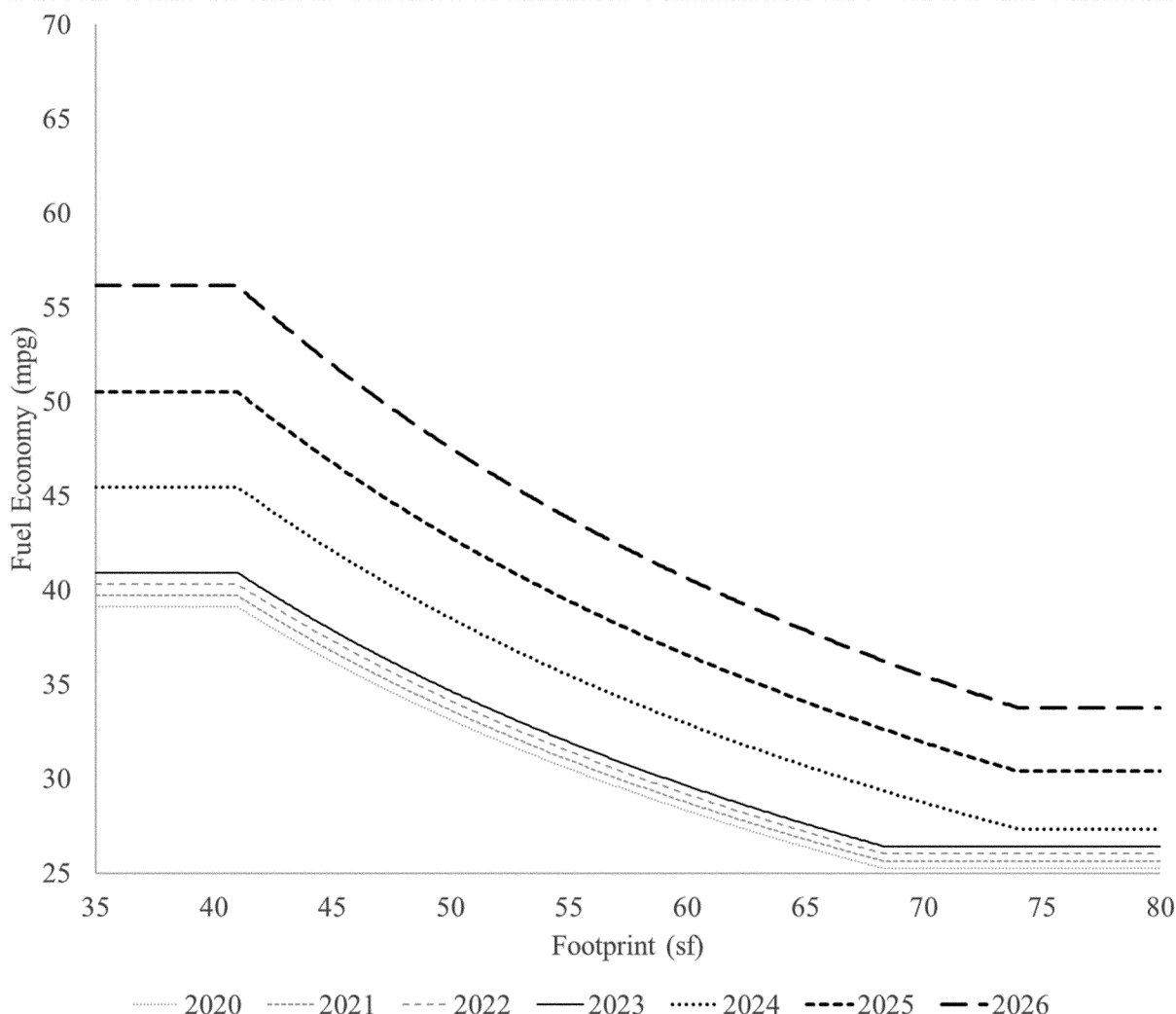

Figure IV-9 – Alternative 3, Light Truck Fuel Economy, Target Curves

Under this alternative, the MDPCS is as follows in Table IV-19.

Table IV-19 – Alternative 3 – Minimum Domestic Passenger Car Standard

2024	2025	2026
45.3 mpg	50.4 mpg	56.0 mpg

NHTSA considered this alternative as a way to evaluate the effects of CAFE standards that would return to a fuel consumption trajectory similar to the standards announced in 2012.

Besides the aforementioned alternatives, some commenters indicated that NHTSA should also consider action alternatives *less* stringent than the No-Action Alternative, while others indicated that NHTSA should also consider action

alternatives *more* stringent than Alternative 3. CEI, for example, argued that less stringent alternatives would result in better safety outcomes, and that not including such alternatives was arbitrary and capricious, such that NHTSA must commence a new rulemaking.⁷⁷⁶ Noting the considerable overcompliance estimated to potentially

⁷⁷⁶ CEI, Docket No. NHTSA-2021-0053-1546, at 2, 8.

occur given reference case fuel price projections, NHTSA concludes that alternatives less stringent than the No-Action Alternative would clearly have fallen short of the maximum feasible, as cost-effective technology to address even modest energy-related economic externalities would have been forgone. Considering such alternatives would not have been a fruitful use of agency resources in this rulemaking. Moreover, NHTSA has accounted for safety

considerations as part of its determination of which standards would be maximum feasible, as discussed in Section VI.

On the other hand, Securing America’s Future Energy commented that NHTSA should explore more stringent alternatives “if the analysis indicates that it will achieve greater fuel economy and there is no obvious obstacle to automakers meeting the more stringent standard.”⁷⁷⁷ Our Children’s Trust and Elders Climate Action both asked NHTSA to consider alternatives that led to greater ZEV penetration. Our Children’s Trust asked specifically for “at least one alternative tiered to a fully electric fleet by 2030” and also “at least one alternative that is aligned with putting the United States transportation system vehicle fleet on an emission reductions pathway consistent with <350 ppm CO₂ by 2100.”⁷⁷⁸ Elders Climate Action asked that the rulemaking be reopened for MY 2026 in order to consider an alternative that would impose a zero emission vehicle standard that would be fully phased in by 2030, beginning with 30 percent ZEV in MY 2026.⁷⁷⁹

In response, while NHTSA appreciates these comments, NHTSA notes that under Alternative 3, average CAFE requirements would increase by nearly 30 percent over a three-year period. While developing circumstances may warrant consideration of even more aggressive regulatory alternatives in future CAFE rulemakings, NHTSA cannot ignore that manufacturers will begin producing MY 2024 vehicles in

less than two years, and that designs and contractual arrangements (e.g., with suppliers) for many MY 2026 vehicles are likely already somewhat firmly established, such that alternatives more aggressive than Alternative 3 would likely not be economically practicable. NHTSA also does not believe it likely has authority to establish a specific ZEV-mandate-type standard as requested by Elders Climate Action, given the restrictions in 49 U.S.C. 32902(h). With regard to the request that NHTSA create and consider an alternative “that is aligned with putting the United States transportation system vehicle fleet on an emission reductions pathway consistent with <350 ppm CO₂ by 2100,” in this action, NHTSA is regulating only the fuel economy of new light-duty vehicles. NHTSA does not have an integrated model of global emissions with which we could assess precisely what emissions reduction pathway for the entire U.S. transportation system (and then, the new light-duty fleet in particular) would need to be on in order to achieve this goal. NHTSA will discuss this question further with relevant interagency partners and consider whether it can be better answered as part of a subsequent rulemaking.

V. Effects of the Regulatory Alternatives

A. Effects on Vehicle Manufacturers

Each of the regulatory alternatives NHTSA considered for this final action would increase the stringency of both passenger car and light truck CAFE standards in each of MYs 2024–2026 as

compared to the standards set in 2020. To estimate the potential impacts of each of these alternatives, NHTSA has, as for all recent rulemakings, assumed that standards would continue unchanged after the last model year (in this case, 2026) to be covered by newly issued standards. NHTSA recognizes that it is possible that the size and composition of the fleet (i.e., in terms of distribution across the range of vehicle footprints) could change over time, affecting the average fuel economy requirements under both the passenger car and light truck standards, and for the overall fleet. If fleet changes ultimately differ from NHTSA’s projections, average requirements could, therefore, also differ from NHTSA’s projections.

Following are both the proposed and final estimated required average fuel economy values for the passenger car, light truck, and total fleets for each regulatory alternative that the agency considered. Overall, the estimated required fuel economy values are generally the same as the proposal, although for some years the values have changed minimally. These minimal changes result from the final rule modeling input revisions, where technology assumptions and costs influence the estimated capabilities of the fleet to attain the required values. We note that in the case of every fleet, the final MY 2029 values did not change from the proposal to the final estimated values.

BILLING CODE 4910–59–P

Table V-1 – Proposed Estimated Required Average Fuel Economy (mpg), Passenger Car Fleet for Manufacturer (Total)

Model Year	2020	2021	2022	2023	2024	2025	2026	2027	2028	2029
Alternative 0 (Baseline)	43.3	43.9	44.6	45.2	45.9	46.6	47.3	47.3	47.3	47.3
Alternative 1	43.3	43.9	44.6	45.2	49.8	51.5	53.2	53.2	53.2	53.2
Alternative 2	43.3	43.9	44.6	45.2	49.2	53.4	58.1	58.1	58.1	58.1
Alternative 3	43.3	43.9	44.6	45.2	50.2	55.8	62.0	62.0	62.0	62.0

⁷⁷⁷ Securing America’s Future Energy, Docket No. NHTSA–2021–0053–1513, at 8.

⁷⁷⁸ Our Children’s Trust, Docket No. NHTSA–2021–0053–1587, at 4.

⁷⁷⁹ Elders Climate Action, Docket No. NHTSA–2021–0053–1589, at 2–3.

Table V-2 – Final Estimated Required Average Fuel Economy (mpg), Passenger Car Fleet

Model Year	2020	2021	2022	2023	2024	2025	2026	2027	2028	2029
Alternative 0 (Baseline)	43.3	43.9	44.6	45.2	45.9	46.6	47.3	47.3	47.3	47.3
Alternative 1	43.3	43.9	44.6	45.2	49.8	51.5	53.2	53.2	53.2	53.2
Alternative 2	43.3	43.9	44.6	45.2	49.2	53.4	58.1	58.1	58.1	58.1
Alternative 2.5	43.3	43.9	44.6	45.2	49.2	53.4	59.4	59.4	59.3	59.3
Alternative 3	43.3	43.9	44.6	45.2	50.2	55.8	62.0	62.0	62.0	62.0

Table V-3 – Proposed Estimated Required Average Fuel Economy (mpg), Light Truck Fleet for Manufacturer (Total)

Model Year	2020	2021	2022	2023	2024	2025	2026	2027	2028	2029
Alternative 0 (Baseline)	31.0	31.5	31.9	32.4	32.9	33.5	33.9	33.9	33.9	33.9
Alternative 1	31.0	31.5	31.9	32.4	36.4	37.7	39.0	39.0	39.0	39.0
Alternative 2	31.0	31.5	31.9	32.4	35.1	38.2	41.5	41.5	41.5	41.5
Alternative 3	31.0	31.5	31.9	32.4	35.9	39.9	44.3	44.3	44.3	44.3

Table V-4 – Final Estimated Required Average Fuel Economy (mpg), Light Truck

Model Year	2020	2021	2022	2023	2024	2025	2026	2027	2028	2029
Alternative 0 (Baseline)	31.0	31.5	31.9	32.4	32.9	33.5	33.9	33.9	33.9	33.9
Alternative 1	31.0	31.5	31.9	32.4	36.4	37.7	39.0	39.0	39.0	39.0
Alternative 2	31.0	31.5	31.9	32.4	35.1	38.2	41.5	41.5	41.5	41.5
Alternative 2.5	31.0	31.5	31.9	32.4	35.1	38.2	42.4	42.4	42.4	42.4
Alternative 3	31.0	31.5	31.9	32.4	35.9	39.9	44.3	44.3	44.3	44.3

Table V-5 – Estimated Required Average Fuel Economy (mpg), Total Fleet for Manufacturer (Total)

Model Year	2020	2021	2022	2023	2024	2025	2026	2027	2028	2029
Alternative 0 (Baseline)	35.4	36.0	36.8	37.4	38.1	38.7	39.4	39.4	39.5	39.5
Alternative 1	35.4	36.0	36.8	37.4	41.8	43.2	44.7	44.8	44.8	44.9
Alternative 2	35.4	36.0	36.8	37.4	40.7	44.2	48.1	48.1	48.2	48.2
Alternative 3	35.4	36.0	36.8	37.4	41.5	46.2	51.3	51.3	51.3	51.4

Table V-6 – Final Estimated Required Average Fuel Economy (mpg), Total Fleet

Model Year	2020	2021	2022	2023	2024	2025	2026	2027	2028	2029
Alternative 0 (Baseline)	35.4	36.0	36.7	37.4	38.1	38.7	39.4	39.4	39.5	39.5
Alternative 1	35.4	36.0	36.7	37.4	41.8	43.2	44.7	44.8	44.8	44.9
Alternative 2	35.4	36.0	36.7	37.4	40.6	44.2	48.1	48.1	48.2	48.2
Alternative 2.5	35.4	36.0	36.7	37.4	40.6	44.2	49.1	49.1	49.2	49.3
Alternative 3	35.4	36.0	36.7	37.4	41.5	46.1	51.3	51.3	51.3	51.4

Manufacturers do not always comply exactly with each CAFE standard in each model year. To date, some manufacturers have tended to regularly exceed one or both requirements. Many manufacturers make use of EPCA's provisions allowing CAFE compliance credits to be applied when a fleet's CAFE level falls short of the corresponding requirement in a given model year. Some manufacturers have paid civil penalties (*i.e.*, fines) required under EPCA when a fleet falls short of a standard in a given model year and the manufacturer lacks compliance credits sufficient to address the compliance

shortfall. As discussed in the accompanying FRIA and TSD, NHTSA simulates manufacturers' responses to each alternative given a wide range of input estimates (*e.g.*, technology cost and efficacy, fuel prices), and, per EPCA requirements, setting aside the potential that any manufacturer would respond to CAFE standards in MYs 2024–2026 by applying CAFE compliance credits or introducing new models of alternative fuel vehicles. Many of these inputs are subject to uncertainty and, in any event, as in all CAFE rulemakings, NHTSA's analysis merely illustrates one set of ways manufacturers could potentially

respond to each regulatory alternative. For this final rule, NHTSA estimates that manufacturers' responses to standards defining each alternative could lead average fuel economy levels to increase through MY 2029 as shown in the following tables. Changes are shown to occur in MY 2023 even though NHTSA is not explicitly proposing to regulate that model year because NHTSA anticipates that manufacturers could potentially make changes as early as that model year to affect future compliance positions (*i.e.*, multi-year planning) for the model years being regulated.

Table V-7 – Proposed Estimated Achieved Average Fuel Economy (mpg), Passenger Car Fleet for Manufacturer (Total)

Model Year	2020	2021	2022	2023	2024	2025	2026	2027	2028	2029
Alternative 0 (Baseline)	41.7	43.6	46.6	48.3	50.4	51.5	52.4	52.8	53.0	53.4
Alternative 1	41.7	43.6	46.6	49.3	52.6	54.6	55.8	56.3	56.7	57.0
Alternative 2	41.7	43.6	46.6	49.7	53.9	57.1	59.6	60.5	61.3	61.4
Alternative 3	41.7	43.6	46.6	50.1	55.3	59.4	62.9	64.1	65.3	65.5

Table V-8 – Final Estimated Achieved Average Fuel Economy (mpg), Passenger Car Fleet

Model Year	2020	2021	2022	2023	2024	2025	2026	2027	2028	2029
Alternative 0 (Baseline)	41.8	43.7	46.9	48.4	50.4	51.5	52.4	52.8	52.9	53.3
Alternative 1	41.8	43.7	46.9	49.0	52.3	54.1	55.7	56.1	56.5	56.8
Alternative 2	41.8	43.7	46.9	49.8	54.1	57.2	59.7	60.6	61.1	61.2
Alternative 2.5	41.8	43.7	46.9	50.0	54.7	57.9	60.9	61.8	62.5	62.6
Alternative 3	41.8	43.7	46.9	50.3	55.8	59.6	63.0	64.2	65.1	65.2

Table V-9 – Proposed Estimated Achieved Average Fuel Economy (mpg), Light Truck Fleet for Manufacturer (Total)

Model Year	2020	2021	2022	2023	2024	2025	2026	2027	2028	2029
Alternative 0 (Baseline)	30.2	31.5	33.1	34.4	35.5	36.0	37.0	37.2	37.4	37.7
Alternative 1	30.2	31.5	33.1	34.6	36.6	37.5	38.7	39.2	39.5	39.8
Alternative 2	30.2	31.5	33.1	34.8	36.5	37.9	40.2	40.7	41.1	41.4
Alternative 3	30.2	31.5	33.1	34.9	37.4	39.1	41.8	42.5	43.0	43.2

Table V-10 – Final Estimated Achieved Average Fuel Economy (mpg), Light Truck Fleet

Model Year	2020	2021	2022	2023	2024	2025	2026	2027	2028	2029
Alternative 0 (Baseline)	30.2	31.5	33.0	34.6	35.6	36.1	36.9	37.1	37.3	37.5
Alternative 1	30.2	31.5	33.0	34.9	36.7	37.5	38.8	39.3	39.7	40.0
Alternative 2	30.2	31.5	33.0	35.0	36.7	37.9	40.2	40.8	41.2	41.6
Alternative 2.5	30.2	31.5	33.0	35.0	36.8	38.0	40.7	41.4	41.8	42.1
Alternative 3	30.2	31.5	33.0	35.2	37.5	39.1	41.9	42.6	43.2	43.4

Table V-11 – Proposed Estimated Achieved Average Fuel Economy (mpg), Total Fleet for Manufacturer (Total)

Model Year	2020	2021	2022	2023	2024	2025	2026	2027	2028	2029
Alternative 0 (Baseline)	34.3	35.9	38.2	39.8	41.3	42.1	43.2	43.5	43.8	44.2
Alternative 1	34.3	35.9	38.2	40.3	42.8	44.1	45.5	46.0	46.4	46.8
Alternative 2	34.3	35.9	38.2	40.5	43.2	45.1	47.6	48.3	48.9	49.2
Alternative 3	34.3	35.9	38.2	40.7	44.2	46.6	49.7	50.6	51.4	51.7

Table V-12 – Final Estimated Achieved Average Fuel Economy (mpg), Total Fleet

Model Year	2020	2021	2022	2023	2024	2025	2026	2027	2028	2029
Alternative 0 (Baseline)	34.4	36.0	38.2	40.0	41.4	42.2	43.2	43.4	43.7	44.1
Alternative 1	34.4	36.0	38.2	40.3	42.7	44.0	45.5	46.0	46.4	46.8
Alternative 2	34.4	36.0	38.2	40.7	43.3	45.2	47.7	48.4	48.9	49.3
Alternative 2.5	34.4	36.0	38.2	40.8	43.5	45.4	48.4	49.1	49.7	50.0
Alternative 3	34.4	36.0	38.2	41.0	44.4	46.7	49.8	50.7	51.4	51.7

While these increases in average fuel economy reflect currently estimated changes in the composition of the fleet (*i.e.*, the relative shares of passenger cars and light trucks), they result almost wholly from the projected application of fuel-saving technology. As mentioned above, NHTSA’s analysis merely illustrates one set of ways manufacturers could potentially respond to each regulatory alternative. Manufacturers’ actual responses will almost assuredly differ from NHTSA’s current estimates.

At the time of the proposal, NHTSA estimated that manufacturers’ application of advanced gasoline engines (*i.e.*, gasoline engines with cylinder deactivation, turbocharging, high or variable compression ratios) could increase through MY 2029 under the No-Action Alternative and through at least MY 2024 under each of the action alternatives. However, NHTSA also estimated that in MY 2024, reliance on advanced gasoline engines could begin to decline under the more stringent action alternatives, as

manufacturers shift toward electrification (which includes hybridization). Based on the updated analysis used for the final rule, these trends continue to mirror the trends identified in the proposal, but at more aggressive rates. Overall, advanced gasoline engine penetration rates increase. Under Alternatives 2, 2.5, and 3, the shift to electrification appears to continue, notably for both passenger cars and light trucks under Alternative 3.

BILLING CODE 4910-59-P

Table V-13 – Proposed Estimated Advanced Gasoline Engine Penetration Rate, Passenger Car Fleet for Manufacturer (Total)

Model Year	2020	2021	2022	2023	2024	2025	2026	2027	2028	2029
Alternative 0 (Baseline)	53%	56%	61%	59%	64%	62%	61%	62%	61%	65%
Alternative 1	53%	56%	61%	59%	63%	62%	64%	64%	65%	69%
Alternative 2	53%	56%	61%	59%	66%	63%	62%	62%	62%	62%
Alternative 3	53%	56%	61%	58%	65%	58%	55%	52%	52%	52%

Table V-14 – Final Estimated Advanced Gasoline Engine Penetration Rate, Passenger Car Fleet

Model Year	2020	2021	2022	2023	2024	2025	2026	2027	2028	2029
Alternative 0 (Baseline)	39%	39%	42%	43%	42%	42%	42%	43%	43%	47%
Alternative 1	39%	39%	42%	41%	40%	39%	40%	41%	41%	45%
Alternative 2	39%	39%	42%	41%	43%	40%	41%	41%	40%	40%
Alternative 2.5	39%	39%	42%	40%	42%	39%	39%	39%	38%	38%
Alternative 3	39%	39%	42%	39%	37%	34%	33%	32%	31%	31%

Table V-15 – Proposed Estimated Advanced Gasoline Engine Penetration Rate, Light Truck Fleet for Manufacturer (Total)

Model Year	2020	2021	2022	2023	2024	2025	2026	2027	2028	2029
Alternative 0 (Baseline)	55%	55%	56%	56%	57%	59%	61%	61%	63%	64%
Alternative 1	55%	55%	56%	57%	57%	57%	58%	57%	57%	56%
Alternative 2	55%	55%	56%	56%	56%	54%	53%	52%	52%	52%
Alternative 3	55%	55%	56%	56%	55%	53%	48%	46%	45%	45%

Table V-16 – Final Estimated Advanced Gasoline Engine Penetration Rate, Light Truck Fleet

Model Year	2020	2021	2022	2023	2024	2025	2026	2027	2028	2029
Alternative 0 (Baseline)	52%	54%	59%	61%	60%	60%	67%	68%	71%	72%
Alternative 1	52%	54%	59%	61%	61%	60%	69%	70%	72%	73%
Alternative 2	52%	54%	59%	61%	61%	57%	62%	63%	66%	68%
Alternative 2.5	52%	54%	59%	61%	60%	56%	60%	61%	64%	65%
Alternative 3	52%	54%	59%	60%	59%	53%	60%	60%	62%	63%

Table V-17 – Proposed Estimated Advanced Gasoline Engine Penetration Rate, Total Fleet for Manufacturer (Total)

Model Year	2020	2021	2022	2023	2024	2025	2026	2027	2028	2029
Alternative 0 (Baseline)	54%	55%	58%	58%	60%	60%	61%	62%	62%	65%
Alternative 1	54%	55%	58%	58%	60%	59%	61%	60%	61%	62%
Alternative 2	54%	55%	58%	58%	61%	58%	57%	57%	57%	57%
Alternative 3	54%	55%	58%	57%	60%	55%	51%	49%	48%	48%

Table V-18 – Final Estimated Advanced Gasoline Engine Penetration Rate, Total Fleet

Model Year	2020	2021	2022	2023	2024	2025	2026	2027	2028	2029
Alternative 0 (Baseline)	57%	61%	66%	69%	71%	72%	77%	77%	78%	81%
Alternative 1	57%	61%	66%	69%	72%	75%	78%	80%	82%	84%
Alternative 2	57%	61%	66%	68%	72%	72%	75%	76%	75%	76%
Alternative 2.5	57%	61%	66%	67%	71%	71%	72%	71%	73%	73%
Alternative 3	57%	61%	66%	68%	68%	67%	67%	68%	69%	70%

As in the NPRM, the aforementioned estimated shift to electrification under the more stringent regulatory alternatives is the most pronounced for hybrid-electric vehicles (*i.e.*, “mild” ISG

HEVs and “strong” P2 and Power-Split HEVs) for the total fleet under the final rule analysis, which may be a result of the reduction in strong hybrid costs. Passenger cars adopt hybridization at a

slightly higher rate than light trucks; this is most likely a result of the adjustments to off-cycle credit caps analyzed for the final rule.

Table V-19 – Proposed Estimated Hybrid Electric Vehicle (HEV) Penetration Rate, Passenger Car Fleet for Manufacturer (Total)

Model Year	2020	2021	2022	2023	2024	2025	2026	2027	2028	2029
Alternative 0 (Baseline)	4%	4%	4%	4%	7%	7%	8%	8%	8%	8%
Alternative 1	4%	4%	4%	4%	7%	9%	9%	10%	11%	11%
Alternative 2	4%	4%	4%	4%	8%	10%	11%	12%	13%	13%
Alternative 3	4%	4%	4%	5%	11%	17%	20%	21%	23%	23%

Table V-20 – Final Estimated Hybrid Electric Vehicle (HEV) Penetration Rate, Passenger Car Fleet

Model Year	2020	2021	2022	2023	2024	2025	2026	2027	2028	2029
Alternative 0 (Baseline)	4%	4%	4%	5%	7%	8%	8%	8%	8%	8%
Alternative 1	4%	4%	4%	6%	9%	10%	11%	11%	11%	11%
Alternative 2	4%	4%	4%	5%	9%	14%	18%	18%	19%	19%
Alternative 2.5	4%	4%	4%	6%	12%	17%	22%	23%	23%	23%
Alternative 3	4%	4%	4%	7%	14%	20%	25%	25%	26%	26%

Table V-21 – Proposed Estimated Hybrid Electric Vehicle (HEV) Penetration Rate, Light Truck Fleet for Manufacturer (Total)

Model Year	2020	2021	2022	2023	2024	2025	2026	2027	2028	2029
Alternative 0 (Baseline)	6%	9%	10%	12%	15%	15%	17%	17%	17%	17%
Alternative 1	6%	9%	10%	11%	20%	22%	26%	26%	28%	28%
Alternative 2	6%	9%	10%	12%	16%	19%	27%	27%	29%	30%
Alternative 3	6%	9%	10%	13%	19%	21%	29%	30%	32%	32%

Table V-22 – Final Estimated Hybrid Electric Vehicle (HEV) Penetration Rate, Light Truck Fleet

Model Year	2020	2021	2022	2023	2024	2025	2026	2027	2028	2029
Alternative 0 (Baseline)	6%	7%	8%	9%	11%	11%	11%	11%	11%	11%
Alternative 1	6%	7%	8%	9%	15%	16%	16%	16%	16%	16%
Alternative 2	6%	7%	8%	10%	15%	20%	29%	29%	29%	29%
Alternative 2.5	6%	7%	8%	10%	15%	20%	28%	28%	28%	28%
Alternative 3	6%	7%	8%	11%	19%	22%	31%	31%	32%	32%

Table V-23 – Proposed Estimated Hybrid Electric Vehicle (HEV) Penetration Rate, Total Fleet for Manufacturer (Total)

Model Year	2020	2021	2022	2023	2024	2025	2026	2027	2028	2029
Alternative 0 (Baseline)	5%	7%	7%	8%	11%	11%	13%	13%	13%	13%
Alternative 1	5%	7%	7%	8%	14%	16%	18%	18%	20%	20%
Alternative 2	5%	7%	7%	8%	12%	15%	19%	20%	21%	21%
Alternative 3	5%	7%	7%	9%	15%	19%	24%	26%	28%	28%

Table V-24 – Final Estimated Hybrid Electric Vehicle (HEV) Penetration Rate, Total Fleet

Model Year	2020	2021	2022	2023	2024	2025	2026	2027	2028	2029
Alternative 0 (Baseline)	5%	6%	6%	7%	9%	10%	10%	10%	10%	10%
Alternative 1	5%	6%	6%	8%	12%	13%	14%	14%	14%	14%
Alternative 2	5%	6%	6%	8%	13%	17%	24%	24%	24%	24%
Alternative 2.5	5%	6%	6%	8%	14%	19%	25%	25%	26%	26%
Alternative 3	5%	6%	6%	9%	17%	21%	28%	29%	29%	29%

As in the NPRM, under the more stringent action alternatives, NHTSA estimates that manufacturers could increase production of plug-in hybrid

electric vehicles (PHEVs) well over current rates. The PHEV rates decrease for the final rule resulting from the increase in SHEVs, which in turn result

from the previously mentioned cost reductions for that technology.

Table V-25 – Proposed Estimated Plug-In Hybrid Electric Vehicle (PHEV) Penetration Rate, Passenger Car Fleet for Manufacturer (Total)

Model Year	2020	2021	2022	2023	2024	2025	2026	2027	2028	2029
Alternative 0 (Baseline)	1%	1%	1%	1%	1%	1%	2%	2%	2%	1%
Alternative 1	1%	1%	1%	1%	2%	2%	3%	3%	3%	3%
Alternative 2	1%	1%	1%	1%	2%	5%	8%	8%	8%	8%
Alternative 3	1%	1%	1%	1%	2%	7%	10%	10%	10%	10%

Table V-26 – Final Estimated Plug-In Hybrid Electric Vehicle (PHEV) Penetration Rate, Passenger Car Fleet

Model Year	2020	2021	2022	2023	2024	2025	2026	2027	2028	2029
Alternative 0 (Baseline)	1%	1%	1%	1%	1%	1%	2%	1%	1%	1%
Alternative 1	1%	1%	1%	1%	2%	2%	3%	3%	3%	3%
Alternative 2	1%	1%	1%	1%	2%	2%	3%	3%	3%	3%
Alternative 2.5	1%	1%	1%	1%	2%	2%	4%	4%	4%	3%
Alternative 3	1%	1%	1%	1%	2%	3%	5%	5%	5%	4%

Table V-27 – Proposed Estimated Plug-In Hybrid Electric Vehicle (PHEV) Penetration Rate, Light Truck Fleet for Manufacturer (Total)

Model Year	2020	2021	2022	2023	2024	2025	2026	2027	2028	2029
Alternative 0 (Baseline)	0%	0%	0%	0%	1%	1%	1%	1%	1%	1%
Alternative 1	0%	0%	0%	0%	2%	2%	2%	2%	2%	2%
Alternative 2	0%	0%	0%	0%	2%	4%	7%	7%	7%	7%
Alternative 3	0%	0%	0%	0%	4%	8%	12%	12%	12%	11%

Table V-28 – Final Estimated Plug-In Hybrid Electric Vehicle (PHEV) Penetration Rate, Light Truck Fleet

Model Year	2020	2021	2022	2023	2024	2025	2026	2027	2028	2029
Alternative 0 (Baseline)	0%	1%	1%	1%	1%	2%	2%	2%	2%	2%
Alternative 1	0%	1%	1%	1%	2%	2%	2%	3%	3%	3%
Alternative 2	0%	1%	1%	2%	2%	2%	3%	3%	3%	4%
Alternative 2.5	0%	1%	1%	2%	2%	3%	3%	3%	3%	4%
Alternative 3	0%	1%	1%	2%	2%	3%	3%	3%	3%	4%

Table V-29 – Proposed Estimated Plug-In Hybrid Electric Vehicle (PHEV) Penetration Rate, Total Fleet for Manufacturer (Total)

Model Year	2020	2021	2022	2023	2024	2025	2026	2027	2028	2029
Alternative 0 (Baseline)	0%	0%	0%	0%	1%	1%	1%	1%	1%	1%
Alternative 1	0%	0%	0%	0%	2%	2%	3%	3%	3%	2%
Alternative 2	0%	0%	0%	0%	2%	4%	7%	7%	7%	7%
Alternative 3	0%	0%	0%	0%	3%	8%	11%	11%	11%	11%

Table V-30 – Final Estimated Plug-In Hybrid Electric Vehicle (PHEV) Penetration Rate, Total Fleet

Model Year	2020	2021	2022	2023	2024	2025	2026	2027	2028	2029
Alternative 0 (Baseline)	1%	1%	1%	0%	1%	1%	1%	1%	1%	1%
Alternative 1	1%	1%	1%	0%	1%	1%	2%	2%	2%	2%
Alternative 2	1%	1%	1%	0%	1%	1%	3%	3%	3%	2%
Alternative 2.5	1%	1%	1%	0%	1%	2%	3%	3%	3%	3%
Alternative 3	1%	1%	1%	0%	2%	3%	5%	5%	5%	5%

For this notice and accompanying FRIA, NHTSA's analysis excludes the introduction of new dedicated alternative fuel vehicle (AFV) models during MYs 2024–2026 as a response to CAFE standards.⁷⁸⁰ However, NHTSA's

analysis does consider the potential that manufacturers might respond to CAFE standards by introducing new BEV models outside of MYs 2024–2026, and NHTSA's analysis does account for the potential that ZEV mandates could lead

manufacturers to introduce new BEV models even during MYs 2024–2026. Also accounting for shifts in fleet mix, NHTSA projects increased production of BEVs through MY 2029. As shown in the following tables, there is a slight

⁷⁸⁰ The Final SEIS does not make this analytical exclusion.

reduction in estimated BEV penetration rates, which, again, is attributable to an increase in SHEV rates resulting from estimated cost reductions for those technologies.

Table V-31 – Proposed Estimated Battery Electric Vehicle (BEV) Penetration Rate, Passenger Car Fleet for Manufacturer (Total)

Model Year	2020	2021	2022	2023	2024	2025	2026	2027	2028	2029
Alternative 0 (Baseline)	4%	5%	6%	7%	7%	8%	8%	8%	8%	9%
Alternative 1	4%	5%	6%	8%	9%	9%	9%	10%	10%	10%
Alternative 2	4%	5%	6%	9%	9%	10%	10%	10%	11%	11%
Alternative 3	4%	5%	6%	9%	10%	10%	10%	11%	12%	12%

Table V-32 – Final Proposed Estimated Battery Electric Vehicle (BEV) Penetration Rate, Passenger Car Fleet

Model Year	2020	2021	2022	2023	2024	2025	2026	2027	2028	2029
Alternative 0 (Baseline)	4%	5%	6%	6%	7%	7%	7%	8%	8%	8%
Alternative 1	4%	5%	6%	7%	7%	8%	8%	8%	8%	8%
Alternative 2	4%	5%	6%	8%	8%	9%	9%	10%	10%	10%
Alternative 2.5	4%	5%	6%	8%	8%	9%	9%	10%	10%	10%
Alternative 3	4%	5%	6%	8%	9%	9%	9%	10%	10%	11%

Table V-33 – Proposed Estimated Battery Electric Vehicle (BEV) Penetration Rate, Light Truck Fleet for Manufacturer (Total)

Model Year	2020	2021	2022	2023	2024	2025	2026	2027	2028	2029
Alternative 0 (Baseline)	0%	0%	1%	1%	2%	2%	2%	2%	2%	3%
Alternative 1	0%	0%	1%	2%	2%	2%	2%	2%	2%	3%
Alternative 2	0%	0%	1%	2%	2%	2%	3%	3%	3%	3%
Alternative 3	0%	0%	1%	2%	2%	3%	3%	3%	3%	3%

Table V-34 – Final Estimated Battery Electric Vehicle (BEV) Penetration Rate, Light Truck Fleet

Model Year	2020	2021	2022	2023	2024	2025	2026	2027	2028	2029
Alternative 0 (Baseline)	0%	1%	1%	1%	1%	2%	2%	2%	2%	2%
Alternative 1	0%	1%	1%	1%	2%	2%	2%	3%	3%	3%
Alternative 2	0%	1%	1%	2%	2%	2%	3%	3%	3%	4%
Alternative 2.5	0%	1%	1%	2%	2%	3%	3%	3%	3%	4%
Alternative 3	0%	1%	1%	2%	2%	3%	3%	3%	3%	4%

Table V-35 – Proposed Estimated Battery Electric Vehicle (BEV) Penetration Rate, Total Fleet for Manufacturer (Total)

Model Year	2020	2021	2022	2023	2024	2025	2026	2027	2028	2029
Alternative 0 (Baseline)	2%	2%	3%	4%	4%	5%	5%	5%	5%	6%
Alternative 1	2%	2%	3%	5%	5%	6%	6%	6%	6%	6%
Alternative 2	2%	2%	3%	5%	6%	6%	6%	6%	7%	7%
Alternative 3	2%	2%	3%	6%	6%	6%	6%	7%	7%	8%

Table V-36 – Final Estimated Battery Electric Vehicle (BEV) Penetration Rate, Total Fleet

Model Year	2020	2021	2022	2023	2024	2025	2026	2027	2028	2029
Alternative 0 (Baseline)	2%	3%	3%	4%	4%	4%	5%	5%	5%	5%
Alternative 1	2%	3%	3%	4%	4%	5%	5%	5%	5%	6%
Alternative 2	2%	3%	3%	5%	5%	6%	6%	6%	6%	7%
Alternative 2.5	2%	3%	3%	5%	5%	6%	6%	6%	6%	7%
Alternative 3	2%	3%	3%	5%	5%	6%	6%	6%	7%	7%

The FRIA provides a wider-ranging summary of NHTSA's estimates of manufacturers' potential application of fuel-saving technologies (including other types of technologies, such as advanced transmissions, aerodynamic improvements, and reduced vehicle mass) in response to each regulatory alternative. Appendices I and II of the accompanying FRIA provide much more detailed and comprehensive results, and the underlying CAFE Model output files provide all information, including the specific combination of technologies estimated to be applied to every specific vehicle model/configuration in each of MYs 2020–2050.

As with the NPRM, NHTSA's analysis shows manufacturers' regulatory costs

for CAFE standards, CO₂ standards, and ZEV mandates increasing through MY 2029, and (logically) increasing more under the more stringent alternatives. NHTSA estimates that relative to the continued application of MY 2020 technologies, manufacturers' *cumulative* costs during MYs 2023–2029 could total \$137b under the No-Action Alternative, and \$179b, \$224b, \$237b, and \$268b under alternatives 1, 2, 2.5 and 3, respectively, when accounting for fuel-saving technologies estimated to be added under each regulatory alternative (including air conditioning improvements and other off-cycle technologies), and also accounting for CAFE civil penalties that NHTSA estimates some manufacturers could

elect to pay rather than achieving full compliance with CAFE standards in some model years. The table below shows how these costs are estimated to vary among manufacturers, accounting for differences in the quantities of vehicles produced for sale in the U.S. Appendices I and II of the accompanying FRIA present results separately for each manufacturer's passenger car and light truck fleets in each model year under each regulatory alternative, and the underlying CAFE Model output files also show results specific to manufacturers' domestic and imported car fleets. For the final rule analysis, in nearly all cases, the total costs are lower than those estimated in the NPRM.

Table V-37 – Proposed Estimated Cumulative Costs (\$b) During MYs 2023-2029

Manufacturer	Alternative 0	Alternative 1	Alternative 2	Alternative 3
BMW	4	4	5	6
Daimler	5	6	6	7
Stellantis (FCA)	18	21	23	25
Ford	18	22	27	33
General Motors	18	34	39	48
Honda	10	10	15	22
Hyundai	5	8	11	14
Kia	4	6	9	11
Jaguar - Land Rover	1	2	2	2
Mazda	3	4	5	5
Mitsubishi	1	1	1	2
Nissan	6	9	22	24
Subaru	6	9	10	10
Tesla	0	0	0	0
Toyota	12	19	22	29
Volvo	2	2	2	3
Volkswagen	9	8	9	10
Industry Total	121	166	208	251

Table V-38 – Final Estimated Cumulative Costs (\$b) During MYs 2023-2029

Manufacturer	Alternative 0	Alternative 1	Alternative 2	Alternative 2.5	Alternative 3
BMW	5.1	5.2	6.0	6.3	6.9
Daimler	5.3	6.7	7.4	7.7	8.4
Stellantis (FCA)	20.5	25.2	27.9	28.9	31.3
Ford	24.2	25.2	33.0	34.5	39.1
General Motors	19.7	35.0	41.8	44.1	49.8
Honda	12.0	11.6	16.6	19.4	22.8
Hyundai	5.4	8.5	11.3	11.9	13.9
Kia	3.7	5.6	8.3	8.9	10.2
Jaguar - Land Rover	1.3	2.2	2.4	2.5	2.7
Mazda	4.0	4.5	5.3	5.5	5.8
Mitsubishi	0.4	0.9	1.1	1.2	1.5
Nissan	6.7	9.9	21.4	22.2	24.2
Subaru	6.0	7.8	8.3	8.4	9.6
Tesla	0.1	0.1	0.1	0.1	0.1
Toyota	13.0	20.1	22.7	23.6	29.5
Volvo	1.7	2.1	2.3	2.4	2.7
Volkswagen	8.0	8.7	8.6	8.8	9.6
Industry Total	137.1	179.1	224.4	236.5	267.9

As discussed in the TSD, these estimates reflect technology cost inputs that, in turn, reflect a “markup” factor that includes manufacturers’ profits. In

other words, if costs to manufacturers are reflected in vehicle price increases as in the past, NHTSA estimates that the average costs to new vehicle purchasers

could increase through MY 2029 as summarized in Table V–39 through Table V–44.

Table V-39 – Proposed Estimated Average Per Vehicle Regulatory Costs (\$), Passenger Car Fleet

Model Year	2020	2021	2022	2023	2024	2025	2026	2027	2028	2029
Alternative 0 (Baseline)	265	369	586	694	873	1,008	1,076	1,058	1,028	1,001
Alternative 1	265	369	586	896	1,242	1,455	1,550	1,507	1,473	1,426
Alternative 2	265	369	586	1,055	1,521	1,968	2,264	2,198	2,157	2,073
Alternative 3	265	369	586	1,147	1,748	2,327	2,733	2,649	2,607	2,506

Table V-40 – Final Estimated Average Per Vehicle Regulatory Costs (\$), Passenger Car Fleet

Model Year	2020	2021	2022	2023	2024	2025	2026	2027	2028	2029
Alternative 0 (Baseline)	250	328	560	667	827	956	1,029	1,012	983	960
Alternative 1	250	328	560	748	1,106	1,321	1,455	1,417	1,395	1,358
Alternative 2	250	328	560	994	1,441	1,853	2,136	2,063	2,020	1,943
Alternative 2.5	250	328	560	1,031	1,528	1,952	2,294	2,212	2,167	2,084
Alternative 3	250	328	560	1,076	1,709	2,210	2,588	2,490	2,444	2,353

Table V-41 – Proposed Estimated Average Per Vehicle Regulatory Costs (\$), Light Truck Fleet

Model Year	2020	2021	2022	2023	2024	2025	2026	2027	2028	2029
Alternative 0 (Baseline)	155	365	633	833	1,056	1,153	1,257	1,260	1,251	1,240
Alternative 1	155	365	633	888	1,456	1,616	1,748	1,715	1,717	1,684
Alternative 2	155	365	633	933	1,413	1,795	2,210	2,159	2,134	2,086
Alternative 3	155	365	633	980	1,760	2,255	2,810	2,730	2,687	2,619

Table V-42 – Final Estimated Average Per Vehicle Regulatory Costs (\$), Light Truck Fleet

Model Year	2020	2021	2022	2023	2024	2025	2026	2027	2028	2029
Alternative 0 (Baseline)	150	297	531	873	1,075	1,165	1,254	1,255	1,248	1,240
Alternative 1	150	297	531	951	1,445	1,604	1,750	1,718	1,729	1,701
Alternative 2	150	297	531	1,000	1,435	1,779	2,248	2,184	2,173	2,127
Alternative 2.5	150	297	531	1,002	1,461	1,808	2,420	2,344	2,335	2,283
Alternative 3	150	297	531	1,061	1,742	2,224	2,835	2,730	2,719	2,650

Table V-43 – Proposed Estimated Average Per Vehicle Regulatory Costs (\$), Total Fleet

Model Year	2020	2021	2022	2023	2024	2025	2026	2027	2028	2029
Alternative 0 (Baseline)	203	367	611	768	969	1,083	1,169	1,160	1,140	1,120
Alternative 1	203	367	611	892	1,354	1,539	1,653	1,614	1,598	1,557
Alternative 2	203	367	611	991	1,464	1,877	2,236	2,177	2,145	2,080
Alternative 3	203	367	611	1,058	1,754	2,289	2,773	2,692	2,649	2,565

Table V-44 – Final Estimated Average Per Vehicle Regulatory Costs (\$), Total Fleet

Model Year	2020	2021	2022	2023	2024	2025	2026	2027	2028	2029
Alternative 0 (Baseline)	194	311	544	776	957	1,064	1,144	1,135	1,116	1,100
Alternative 1	194	311	544	856	1,283	1,468	1,608	1,572	1,566	1,532
Alternative 2	194	311	544	997	1,438	1,814	2,195	2,126	2,099	2,038
Alternative 2.5	194	311	544	1,016	1,493	1,876	2,360	2,281	2,254	2,187
Alternative 3	194	311	544	1,068	1,726	2,217	2,718	2,616	2,588	2,507

Table V-45 shows how these costs could vary among manufacturers, suggesting that disparities could

decrease as the stringency of standards increases.

Table V-45 – Proposed Average Manufacturer Per-Vehicle Costs by Alternative MY2029

Manufacturer	Alternative 0	Alternative 1	Alternative 2	Alternative 3
BMW	1,604	1,644	2,126	2,607
Daimler	1,583	2,062	2,412	2,741
Stellantis (FCA)	1,527	1,887	2,185	2,484
Ford	1,331	1,488	2,021	2,609
General Motors	1,056	2,014	2,591	3,160
Honda	965	972	1,515	2,107
Hyundai	846	1,516	2,320	2,859
Kia	850	1,295	2,006	2,595
Jaguar - Land Rover	1,168	1,829	2,137	2,479
Mazda	1,523	1,819	2,416	2,829
Mitsubishi	587	1,115	1,720	2,124
Nissan	737	1,134	2,679	3,147
Subaru	1,058	1,568	1,699	1,802
Tesla	47	47	47	47
Toyota	859	1,394	1,583	2,181
Volvo	1,867	2,578	2,855	3,201
Volkswagen	2,459	2,408	2,547	2,937
Industry Average	1,120	1,557	2,080	2,565

Table V-46 – Final Average Manufacturer Per-Vehicle Costs by Alternative MY2029

Manufacturer	Alternative 0	Alternative 1	Alternative 2	Alternative 2.5	Alternative 3
BMW	1,745	1,751	2,261	2,401	2,738
Daimler	1,607	2,135	2,487	2,594	2,870
Stellantis (FCA)	1,532	1,997	2,398	2,543	2,791
Ford	1,499	1,581	2,228	2,415	2,770
General Motors	937	1,898	2,519	2,713	3,022
Honda	1,127	1,091	1,547	1,805	2,111
Hyundai	726	1,358	2,019	2,190	2,554
Kia	607	1,094	1,722	1,823	2,135
Jaguar - Land Rover	1,186	2,293	2,487	2,637	2,943
Mazda	1,473	1,756	2,299	2,472	2,611
Mitsubishi	382	933	1,327	1,496	1,803
Nissan	704	1,092	2,474	2,590	2,882
Subaru	950	1,255	1,383	1,422	1,615
Tesla	31	31	31	31	31
Toyota	868	1,377	1,514	1,601	2,094
Volvo	1,916	2,550	2,771	2,890	3,156
Volkswagen	2,032	2,246	2,265	2,364	2,663
Industry Average	1,100	1,532	2,038	2,187	2,507

NHTSA estimates that although projected fuel savings under the more stringent regulatory alternatives could tend to increase new vehicle sales, this tendency could be outweighed by the opposing response to higher prices, such that new vehicle sales could decline slightly under the more

stringent alternatives. The magnitude of these fuel savings and vehicle price increases depends on manufacturer compliance decisions, especially technology application. In the event that manufacturers select technologies with lower prices and/or higher fuel economy improvements, vehicle sales

effects could differ. For example, in the case of the “unconstrained” Final SEIS results, manufacturer costs across alternatives are lower. As the graphs indicate, the difference between the regulatory alternatives in terms of sales effects decreased between the NPRM and final rule.

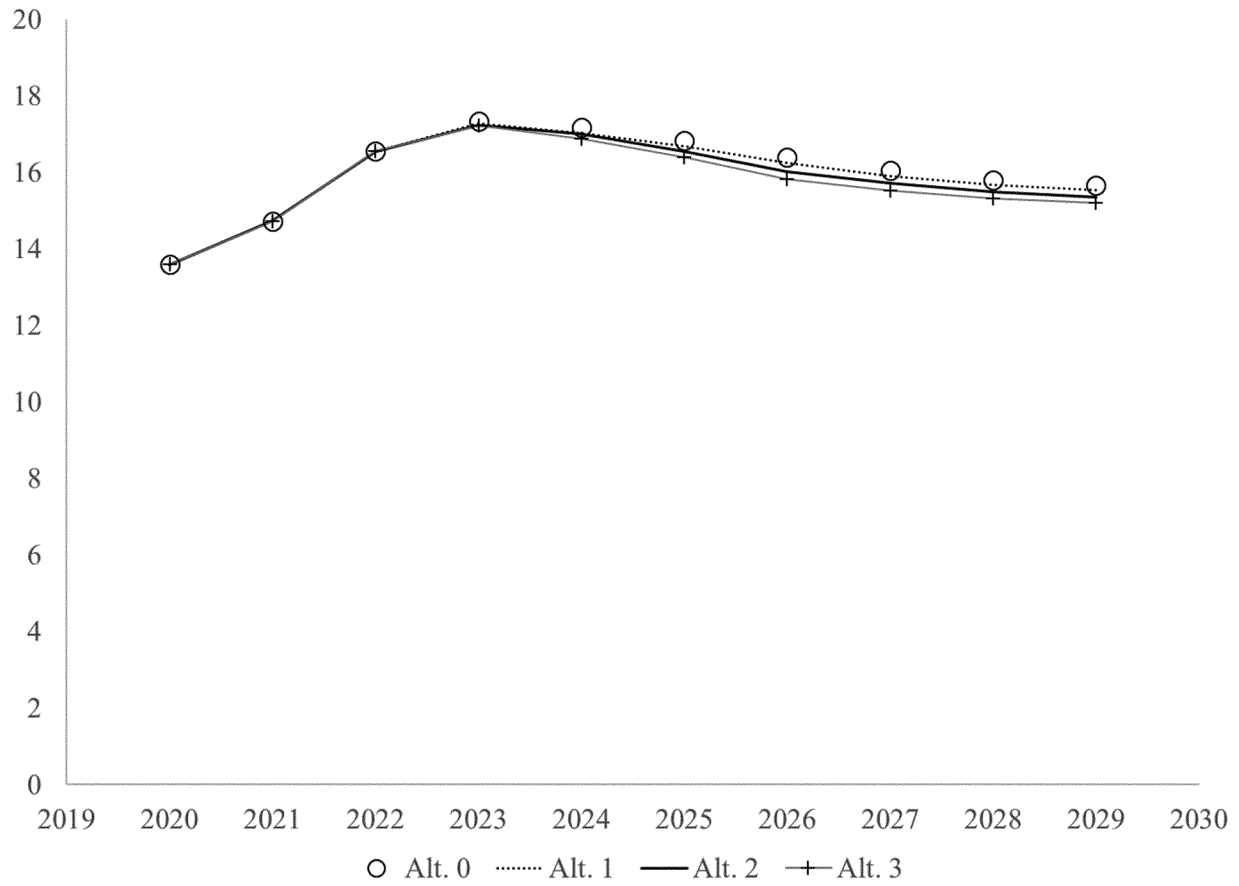

Figure V-1 – Proposed Estimated Annual New Vehicles Sales (Millions)

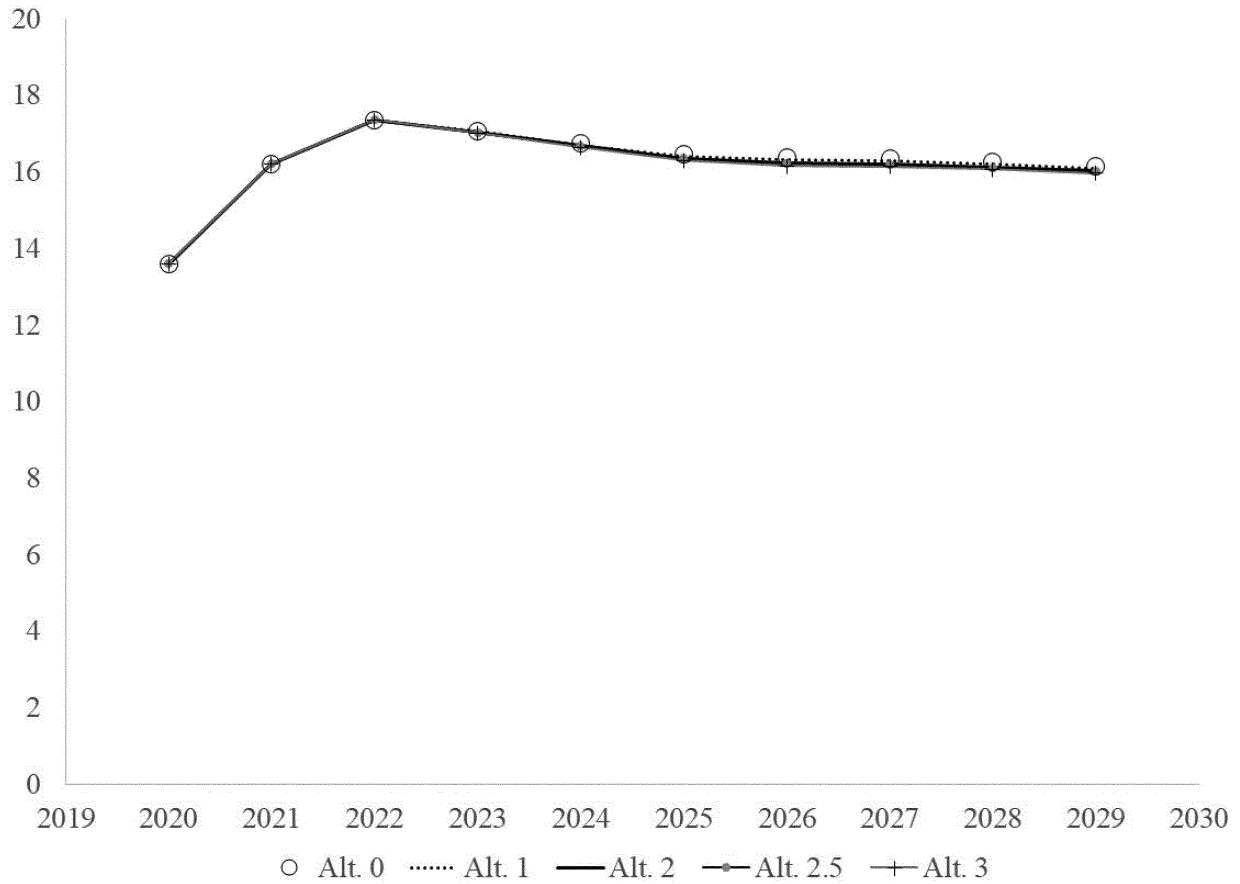

Figure V-2 – Final Estimated Annual New Vehicles Sales (Millions)

The TSD discusses NHTSA’s approach to estimating new vehicle sales, including NHTSA’s estimate that new vehicle sales could recover from 2020’s aberrantly low levels. While these slight reductions in new vehicle sales tend to slightly reduce

projected automobile industry labor, NHTSA estimates that the cost increases could reflect an underlying increase in employment to produce additional fuel-saving technology, such that automobile industry labor could about the same

under each of the four regulatory alternatives. As the graphs indicate, the difference between the regulatory alternatives in terms of employment effects increased slightly between the NPRM and final rule.

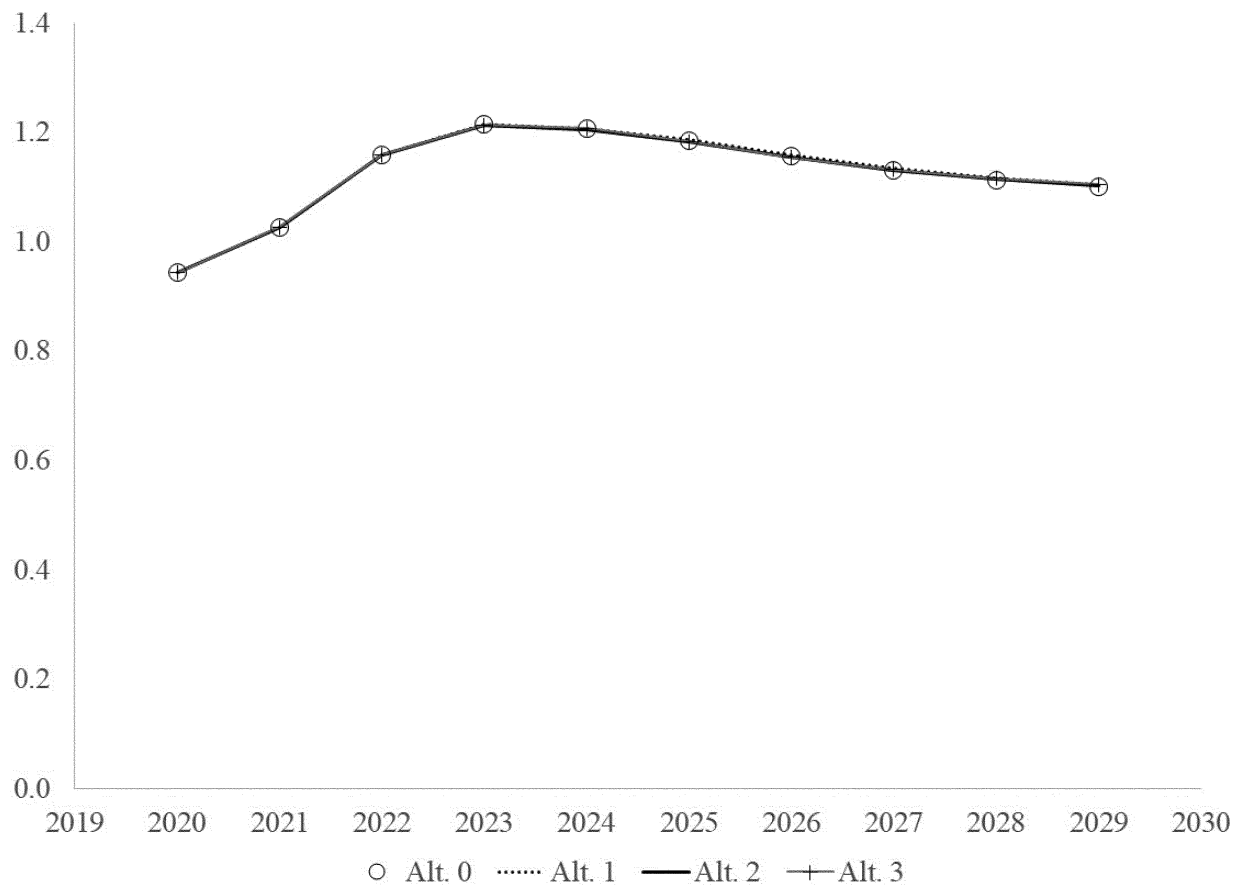

Figure V-3 – Proposed Estimated Automobile Industry Labor (as Millions of Full-Time-Equivalent Jobs)

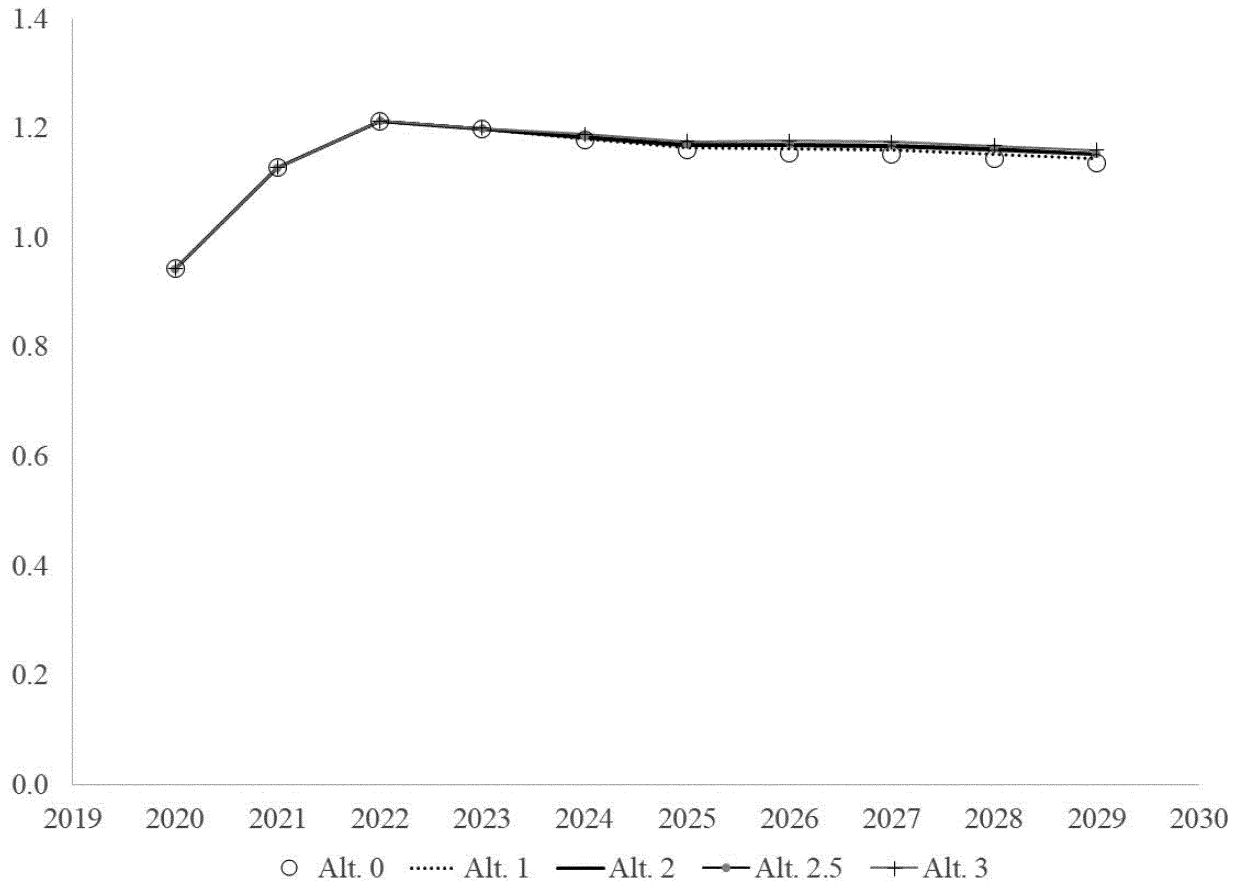

Figure V-4 – Final Estimated Automobile Industry Labor (as Millions of Full-Time-Equivalent Jobs)

The accompanying TSD discusses NHTSA’s approach to estimating automobile industry employment, and the accompanying FRIA (and its Appendices I and II) and CAFE Model output files provide more detailed results of NHTSA’s analysis.

B. Effects on New Car and Truck Buyers

As discussed above, NHTSA estimates that the average fuel economy and purchase cost of new vehicles could increase between MYs 2020 and 2029

and increase more quickly under each of the action alternatives than under the No-Action Alternative. On one hand, buyers could realize the benefits of increased fuel economy: Spending less on fuel. On the other, buyers could pay more for new vehicles, and for some costs tied directly to vehicle value (e.g., sales taxes and collision insurance). The tables that follow present metrics for new car and truck buyers for both the proposed and final rule. Table V-47 and

Table V-48 report sales-weighted MSRP values for the No-Action Alternative and relative increases in MSRP for the three regulatory alternatives. The estimates for the final action suggest slightly larger MSRP increases for light trucks and smaller increases for passenger cars in the final rule compared to the proposal (comparing Alt. 2 in MY 2029). Alternative 2.5 raises MSRP increases to just over \$1,000 by MY 2029.

Table V-47 – Proposed Sales-Weighted MSRP and Incremental Costs Under the Regulatory Alternatives by Regulatory Class, Undiscounted 2018\$

Model Year	Light Truck				Passenger Car			
	Alt. 0	Relative to Alt. 0			Alt. 0	Relative to Alt. 0		
		Alt. 1	Alt. 2	Alt. 3		Alt. 1	Alt. 2	Alt. 3
2024	42,300	400	350	700	31,220	360	640	870
2025	42,400	460	640	1,100	31,360	440	950	1,300
2026	42,500	490	950	1,550	31,440	460	1,170	1,630
2027	42,500	460	900	1,470	31,430	440	1,120	1,550
2028	42,490	470	890	1,440	31,410	430	1,100	1,540
2029	42,480	450	850	1,380	31,390	410	1,040	1,460

Table V-48 – Final Sales-Weighted MSRP and Incremental Costs Under the Regulatory Alternatives by Regulatory Class, Undiscounted 2018\$

Model Year	Light Truck					Passenger Car				
	Alt. 0	Relative to Alt. 0				Alt. 0	Relative to Alt. 0			
		Alt. 1	Alt. 2	Alt. 2.5	Alt. 3		Alt. 1	Alt. 2	Alt. 2.5	Alt. 3
2024	42,320	370	360	380	660	31,170	280	610	700	870
2025	42,410	440	610	640	1,060	31,360	300	830	930	1,180
2026	42,500	490	990	1,160	1,580	31,440	370	1,040	1,190	1,480
2027	42,500	460	930	1,090	1,470	31,430	340	980	1,120	1,390
2028	42,490	480	930	1,090	1,470	31,410	350	960	1,110	1,380
2029	42,480	460	890	1,050	1,410	31,390	340	910	1,050	1,310

Table V-49 through Table V-54 present projected consumer costs and benefits along with net benefits for MYs 2029 and 2039⁷⁸¹ vehicles for each alternative in both the proposal and final rule. Results are shown in 2018 dollars, without discounting and with benefits and costs discounted at annual rates of 3 and 7 percent. The TSD and FRIA accompanying this rule discuss underlying methods, inputs, and results

in greater detail, and more detailed tables and underlying results are contained in Appendix I and the CAFE Model output files. Comparisons of per-vehicle consumer effects between proposal and final rule are best done at the row level, as the final rule includes an additional category accounting for reallocated vehicle miles and excludes financing costs.⁷⁸² For all of the action alternatives, avoided outlays for fuel

purchases⁷⁸³ account for most of the projected incremental benefits to consumers, and increases in the cost to purchase new vehicles account for most of the projected incremental costs. For MY 2029, consumer costs increase slightly between the proposal's Alternative 2 and final rule's Alternative 2.5. Consumer benefits, especially the estimates of retail fuel outlay, also increase.

⁷⁸¹ By 2039, technology costs have been learned down, and fuel prices better reflect longer-term levels.

⁷⁸² The rationale for adjusting this calculation is discussed in TSD Chapter 6.1.5, Benefits of Additional Mobility.

⁷⁸³ Negative "retail fuel outlay" values in the table denote decreases in consumer fuel

expenditure relative to the No-Action Alternative. These decreases in expenditure are considered a benefit and are hence included as a positive value in the calculation of total consumer benefits.

Table V-49 – Proposed Average Per-Vehicle Consumer Benefits and Costs – Passenger Cars and Light Trucks, Undiscounted 2018\$

	MY 2029				MY 2039			
	Alt. 0	Relative to Alt. 0			Alt. 0	Relative to Alt. 0		
		Alt. 1	Alt. 2	Alt. 3		Alt. 1	Alt. 2	Alt. 3
Consumer Costs								
Insurance cost	5,190	73	157	232	5,128	60	116	166
Financing cost	4,153	59	125	186	4,103	48	93	132
Taxes and fees	2,016	28	61	90	1,992	23	45	64
Regulatory cost	1,120	437	960	1,444	924	324	645	934
Forgone consumer sales surplus	0	1	7	17	0	0	1	3
Maintenance and repair cost	0	0	0	0	0	0	0	0
Implicit opportunity cost	0	0	0	0	0	0	0	0
Total consumer costs	12,478	598	1,310	1,970	12,147	456	899	1,299
Consumer Benefits								
Retail fuel outlay	19,703	-738	-1,186	-1,688	19,727	-818	-1,622	-2,351
Refueling time cost	1,046	-1	-2	-15	1,191	15	89	181
Drive value	693	125	160	219	779	137	162	204
Total consumer benefits	21,442	864	1,347	1,922	21,696	940	1,694	2,373
Net benefits	8,964	266	37	-48	9,550	484	795	1,074

Table V-50 – Final Average Per-Vehicle Consumer Benefits and Costs – Passenger Cars and Light Trucks, Undiscounted 2018\$

	MY 2029					MY 2039				
	Alt. 0	Relative to Alt. 0				Alt. 0	Relative to Alt. 0			
		Alt. 1	Alt. 2	Alt. 2.5	Alt. 3		Alt. 1	Alt. 2	Alt. 2.5	Alt. 3
Consumer Costs										
Insurance cost	4,149	59	122	140	182	4,102	47	95	109	141
Taxes and fees	2,014	29	59	68	88	1,992	23	46	53	68
Regulatory cost	1,100	432	938	1,087	1,407	935	314	689	790	1,015
Forgone consumer sales surplus	0	0	2	3	6	0	0	1	1	2
Maintenance and repair cost	0	0	0	0	0	0	0	0	0	0
Implicit opportunity cost	0	0	0	0	0	0	0	0	0	0
Total consumer costs	7,263	520	1,122	1,299	1,683	7,028	383	831	953	1,225
Consumer Benefits										
Retail fuel outlay	19,831	-898	-1,543	-1,738	-2,136	19,803	-788	-1,829	-2,212	-2,785
Refueling time cost	1,025	-10	8	0	-16	1,161	-22	53	104	132
Drive value	574	95	141	154	185	723	92	127	126	142
Reallocated value	0	17	45	51	68	0	6	27	30	40
Total consumer benefits	21,430	1,020	1,721	1,943	2,405	21,687	908	1,931	2,263	2,835
Net benefits	14,167	500	599	644	722	14,659	525	1,100	1,310	1,611

Table V-51 – Proposed Average Per-Vehicle Consumer Benefits and Costs – Passenger Cars and Light Trucks, Discounted at 3 Percent, 2018\$

	MY 2029					MY 2039				
	Alt. 0	Relative to Alt. 0				Alt. 0	Relative to Alt. 0			
		Alt. 1	Alt. 2	Alt. 3	Alt. 1		Alt. 2	Alt. 3		
Consumer Costs										
Insurance cost	4,353	61	131	195	4,301	50	97	139		
Financing cost	3,874	55	117	173	3,828	45	86	124		
Taxes and fees	2,016	28	61	90	1,992	23	45	64		
Regulatory cost	1,120	437	960	1,444	924	324	645	934		
Forgone consumer sales surplus	0	1	7	17	0	0	1	3		
Maintenance and repair cost	0	0	0	0	0	0	0	0		
Implicit opportunity cost	0	0	0	0	0	0	0	0		
Total consumer costs	11,362	582	1,276	1,920	11,044	443	874	1,263		
Consumer Benefits										
Retail fuel outlay	15,510	-581	-937	-1,332	15,652	-648	-1,287	-1,866		
Refueling time cost	834	0	-1	-12	951	13	72	145		
Drive value	546	97	125	171	622	108	128	161		
Total consumer benefits	16,890	679	1,063	1,516	17,226	743	1,343	1,882		
Net benefits	5,527	96	-213	-404	6,182	300	469	619		

Table V-52 – Final Average Per-Vehicle Consumer Benefits and Costs – Passenger Cars and Light Trucks, Discounted at 3 Percent, 2018\$

	MY 2029					MY 2039				
	Alt. 0	Relative to Alt. 0				Alt. 0	Relative to Alt. 0			
		Alt. 1	Alt. 2	Alt. 2.5	Alt. 3		Alt. 1	Alt. 2	Alt. 2.5	Alt. 3
Consumer Costs										
Insurance cost	3,480	49	102	118	152	3,440	39	80	92	118
Taxes and fees	2,014	29	59	68	88	1,992	23	46	53	68
Regulatory cost	1,100	432	938	1,087	1,407	935	314	689	790	1,015
Forgone consumer sales surplus	0	0	2	3	6	0	0	1	1	2
Maintenance and repair cost	0	0	0	0	0	0	0	0	0	0
Implicit opportunity cost	0	0	0	0	0	0	0	0	0	0
Total consumer costs	6,594	511	1,102	1,276	1,654	6,367	376	816	936	1,202
Consumer Benefits										
Retail fuel outlay	15,629	-709	-1,222	-1,377	-1,692	15,741	-626	-1,457	-1,761	-2,216
Refueling time cost	818	-8	6	0	-12	929	-17	42	84	106
Drive value	456	74	111	121	145	588	73	100	99	111
Reallocated value	0	14	37	42	55	0	6	24	26	35
Total consumer benefits	16,903	805	1,363	1,539	1,904	17,258	723	1,539	1,802	2,257
Net benefits	10,309	295	261	262	251	10,891	347	723	866	1,055

Table V-53 – Proposed Average Per-Vehicle Consumer Benefits and Costs – Passenger Cars and Light Trucks, Discounted at 7 Percent, 2018\$

	MY 2029				MY 2039			
	Alt. 0	Relative to Alt. 0			Alt. 0	Relative to Alt. 0		
		Alt. 1	Alt. 2	Alt. 3		Alt. 1	Alt. 2	Alt. 3
Consumer Costs								
Insurance cost	3,619	51	109	162	3,576	42	81	115
Financing cost	3,555	50	107	159	3,512	41	79	113
Taxes and fees	2,016	28	61	90	1,992	23	45	64
Regulatory cost	1,120	437	960	1,444	924	324	645	934
Forgone consumer sales surplus	0	1	7	17	0	0	1	3
Maintenance and repair cost	0	0	0	0	0	0	0	0
Implicit opportunity cost	0	0	0	0	0	0	0	0
Total consumer costs	10,310	568	1,244	1,873	10,004	431	851	1,230
Consumer Benefits								
Retail fuel outlay	12,001	-449	-726	-1,032	12,217	-503	-1,001	-1,453
Refueling time cost	654	0	-1	-9	747	10	56	115
Drive value	422	75	96	132	489	84	100	126
Total consumer benefits	13,077	524	823	1,173	13,453	578	1,045	1,464
Net benefits	2,767	-44	-421	-700	3,449	147	194	234

Table V-54 – Final Average Per-Vehicle Consumer Benefits and Costs – Passenger Cars and Light Trucks, Discounted at 7 Percent, 2018\$

	MY 2029					MY 2039				
	Alt. 0	Relative to Alt. 0				Alt. 0	Relative to Alt. 0			
		Alt. 1	Alt. 2	Alt. 2.5	Alt. 3		Alt. 1	Alt. 2	Alt. 2.5	Alt. 3
Consumer Costs										
Insurance cost	2,894	41	85	98	127	2,861	33	67	76	98
Taxes and fees	2,014	29	59	68	88	1,992	23	46	53	68
Regulatory cost	1,100	432	938	1,087	1,407	935	314	689	790	1,015
Forgone consumer sales surplus	0	0	2	3	6	0	0	1	1	2
Maintenance and repair cost	0	0	0	0	0	0	0	0	0	0
Implicit opportunity cost	0	0	0	0	0	0	0	0	0	0
Total consumer costs	6,008	502	1,085	1,256	1,628	5,787	369	802	920	1,182
Consumer Benefits										
Retail fuel outlay	12,107	-550	-950	-1,070	-1,315	12,310	-488	-1,139	-1,377	-1,732
Refueling time cost	642	-6	5	0	-10	731	-14	33	66	83
Drive value	356	57	85	93	111	471	57	78	76	86
Reallocated value	0	11	29	33	43	0	6	21	23	31
Total consumer benefits	13,105	625	1,059	1,196	1,479	13,512	565	1,204	1,410	1,765
Net benefits	7,097	122	-26	-61	-149	7,725	196	402	490	583

C. Effects on Society

Table V-55 describes the costs and benefits of increasing CAFE standards in each alternative, as well as the party to which they accrue. Manufacturers are directly regulated under the program and incur additional production costs when they apply technology to their vehicle offerings in order to improve their fuel economy. In this analysis, we assume that those costs are fully passed through to new car and truck buyers, in the form of higher prices. Other assumptions are possible, but we do not currently have data to support attempting to model cross-subsidization. We also assume that any civil penalties—paid by manufacturers for failing to comply with their CAFE standards—are passed through to new car and truck buyers and are included in the sales price. However, those civil penalties are paid to the U.S. Treasury, where they currently fund the general business of government. As such, they are a transfer from new vehicle buyers to all U.S. citizens, who then benefit from the additional Federal revenue. While they are calculated in the analysis, and do influence consumer

decisions in the marketplace, they do not contribute to the calculation of net benefits (and are omitted from the tables below).

While incremental maintenance and repair costs would accrue to buyers of new cars and trucks affected by more stringent CAFE standards, we do not carry these costs in the analysis. They are difficult to estimate for emerging technologies but represent real costs (and benefits in the case of alternative fuel vehicles that may require less frequent maintenance events). They may be included in future analyses as data become available to evaluate lifetime maintenance costs. This analysis assumes that drivers of new vehicles internalize 90 percent of the risk associated with increased exposure to crashes when they engage in additional travel (as a consequence of the rebound effect).

Private benefits are dominated by the value of fuel savings, which accrue to new car and truck buyers at retail fuel prices (inclusive of Federal and state taxes). In addition to saving money on fuel purchases, new vehicle buyers also benefit from the increased mobility that results from the lower cost of driving

their vehicle (higher fuel economy reduces the per-mile cost of travel) and fewer refueling events. The additional travel occurs as drivers take advantage of lower operating costs to increase mobility, and this generates benefits to those drivers—equivalent to the cost of operating their vehicles to travel those miles, the consumer surplus, and the offsetting benefit that represents 90 percent of the additional safety risk from travel.

In addition to private benefits and costs, there are purely external benefits and costs that can be attributed to increases in CAFE standards. These are benefits and costs that accrue to society more generally, rather than to the specific individuals who purchase a new vehicle that was produced under more stringent CAFE standards. Of the external costs, the largest is the loss in fuel tax revenue that occurs as a result of falling fuel consumption. While drivers of new vehicles (purchased in years where CAFE stringency is increasing) save fuel costs at retail prices, the rest of U.S. road users experience a welfare loss, in two ways. First, the revenue generated by fuel

taxes helps to maintain roads and bridges, and improve infrastructure more generally, and that loss in fuel tax revenue is a social cost. And second, the additional driving that occurs as new vehicle buyers take advantage of lower per-mile fuel costs is a benefit to those drivers, but the congestion (and road noise) created by the additional travel impose a social cost to all road users.

Among the purely external benefits created when CAFE standards are increased, the largest is the reduction in damages resulting from greenhouse gas

emissions. Table V-55 shows these reduced climate damages, assuming different SC-GHG discount rates. The associated benefits related to reduced health damages from conventional pollutants and the benefit of improved energy security are both significantly smaller than the associated change in GHG damages across alternatives. Benefits from improved energy security are, however, very difficult to quantify and are likely understated. As the table also illustrates, the overwhelming majority of both costs and benefits are

private costs and benefits that accrue to buyers of new cars and trucks, rather than external welfare changes that affect society more generally. This has been consistently true in CAFE rulemakings.

The choice of discount rate affects the magnitude of the resulting benefits and costs, as shown in Table V-55. Many benefits of the regulatory alternatives, but especially Alternative 3, are concentrated in later years where a higher discount rate has a greater contracting effect.

Table V-55 – Incremental Benefits and Costs (Relative to Alternative 0) Over the Lifetimes of Total Fleet Produced Through 2029 (2018\$ Billions), by Alternative

	3% Discount Rate				7% Discount Rate			
	Alt. 1	Alt. 2	Alt 2.5	Alt. 3	Alt. 1	Alt. 2	Alt 2.5	Alt. 3
Private Costs								
Technology Costs to Increase Fuel Economy	31.7	67.4	76.4	100.2	25.8	54.7	62	81.4
Increased Maintenance and Repair Costs	0.0	0.0	0.0	0.0	0.0	0.0	0.0	0.0
Opportunity Cost in Other Vehicle Attributes	0.0	0.0	0.0	0.0	0.0	0.0	0.0	0.0
Consumer Surplus Loss from Reduced New Vehicle Sales	0.0	0.2	0.3	0.5	0.0	0.2	0.2	0.4
Safety Costs Internalized by Drivers	5.0	7.9	8.7	10.7	3.0	4.8	5.3	6.5
Subtotal - Private Costs	36.7	75.4	85.4	111.4	28.8	59.6	67.5	88.2
Social Costs								
Congestion and Noise Costs from Rebound-Effect Driving	6.1	9.8	10.8	13.0	3.9	6.3	7.1	8.5
Safety Costs Not Internalized by Drivers	4.5	8.8	9.7	12.8	3.1	6.3	7.1	9.4
Loss in Fuel Tax Revenue	11.3	20.0	22.4	28.6	7.2	12.7	14.2	18.1
Subtotal - Social Costs	21.9	38.5	43	54.4	14.2	25.3	28.3	36.0
Total Social Costs	58.6	113.9	128.4	165.8	43.0	84.9	95.8	124.3
Private Benefits								
Reduced Fuel Costs	52.5	88.1	98.2	123.5	32.7	54.7	61	76.7
Benefits from Additional Driving	9.9	14.9	16.4	19.8	6.0	9.1	10	12.1
Less Frequent Refueling	0.3	-1.3	-0.8	0.1	0.1	-0.9	-0.6	-0.1
Subtotal - Private Benefits	62.7	101.7	113.8	143.4	38.8	62.9	70.3	88.8
External Benefits								
Reduction in Petroleum Market Externality	0.9	1.6	1.8	2.3	0.5	1.0	1.1	1.4
Reduced Health Damages	1.2	1.5	1.5	1.7	0.7	0.8	0.8	0.9
Reduced Climate Damages								
SC-GHG @ 5% DR	3.7	6.3	7.1	8.9	3.7	6.3	7.1	8.9
SC-GHG @ 3% DR	14.4	24.6	27.5	34.8	14.4	24.6	27.5	34.8
SC-GHG @ 2.5% DR	21.9	37.4	41.8	52.9	21.9	37.4	41.8	52.9
SC-GHG @ 3% at 95th pctile DR	43.6	74.4	83.2	105.1	43.6	74.4	83.2	105.1
Total Social Benefits								
SC-GHG @ 5% DR	68.5	111.1	124.2	156.4	43.8	71.0	79.3	100.0
SC-GHG @ 3% DR	79.2	129.4	144.6	182.2	54.5	89.3	99.7	125.8
SC-GHG @ 2.5% DR	86.7	142.2	158.9	200.3	62.0	102.1	114.1	143.9
SC-GHG @ 3% at 95th pctile DR	108.4	179.2	200.3	252.5	83.6	139.0	155.4	196.1
Net Social Benefits								
SC-GHG @ 5% DR	9.9	-2.8	-4.2	-9.4	0.8	-13.9	-16.5	-24.3
SC-GHG @ 3% DR	20.6	15.5	16.3	16.4	11.5	4.3	3.9	1.5
SC-GHG @ 2.5% DR	28.1	28.3	30.6	34.5	19.0	17.2	18.3	19.6
SC-GHG @ 3% at 95th pctile DR	49.8	65.2	71.9	86.7	40.6	54.1	59.6	71.8

The following tables show the costs and benefits associated with external effects to society. As seen in Table V-55, the external benefits are composed of reduced climate damages (Table V-56 through Table V-59), reduced health

damages (Table V-60 and Table V-61), and reduced petroleum market externalities (Table V-64). The external costs to society include congestion and noise costs (Table V-62 and Table V-63) and safety costs (Table V-65). We show

the costs and benefits by model year (1981–2029), in contrast to the tables above, which present incremental and net costs and benefits over the lifetimes of the entire fleet produced through 2029, beginning with MY 1981.

Table V-56 – Total and Incremental Costs of GHGs (2018\$, billions), MY 1981-2029, 2.5 Percent Discount Rate, by Alternative

Model Year:	1981 - 2023	2024	2025	2026	2027	2028	2029	Total
Alternative 0 (Totals)								
CO ₂	1,242.0	90.6	86.7	83.7	82.0	80.1	78.0	1,743.1
CH ₄	44.9	3.4	3.3	3.2	3.2	3.1	3.1	64.1
N ₂ O	18.0	1.1	1.1	1.1	1.0	1.0	1.0	24.3
Alternative 1 (Relative to Alternative 0)								
CO ₂	0.24	-2.59	-3.12	-3.72	-3.88	-4.02	-3.86	-20.96
CH ₄	0.01	-0.09	-0.11	-0.14	-0.14	-0.15	-0.14	-0.76
N ₂ O	0.01	-0.03	-0.03	-0.04	-0.04	-0.04	-0.04	-0.21
Alternative 2 (Relative to Alternative 0)								
CO ₂	0.89	-3.50	-4.99	-6.91	-7.15	-7.24	-6.88	-35.78
CH ₄	0.04	-0.12	-0.18	-0.25	-0.25	-0.26	-0.25	-1.27
N ₂ O	0.02	-0.04	-0.05	-0.07	-0.08	-0.08	-0.07	-0.37
Alternative 2.5 (Relative to Alternative 0)								
CO ₂	1.10	-3.86	-5.39	-7.82	-8.06	-8.18	-7.79	-40.01
CH ₄	0.05	-0.13	-0.19	-0.28	-0.29	-0.29	-0.28	-1.41
N ₂ O	0.02	-0.04	-0.06	-0.08	-0.09	-0.09	-0.08	-0.42
Alternative 3 (Relative to Alternative 0)								
CO ₂	1.66	-5.38	-7.27	-9.73	-9.99	-10.19	-9.67	-50.56
CH ₄	0.07	-0.19	-0.25	-0.34	-0.35	-0.36	-0.35	-1.77
N ₂ O	0.03	-0.06	-0.08	-0.10	-0.11	-0.11	-0.11	-0.54

Table V-56 through Table V-59 present the total costs of GHGs in Alternative 0 and the incremental costs relative to Alternative 0 in the other three alternatives. Each table presents GHG costs using different SC-GHG values (discounted at 2.5 percent, 3 percent, 5 percent, and the 95th percentile values at 3 percent). See

Chapter 6.2.1 of the TSD accompanying this notice for discussion of the SC-GHG discount rates. Negative incremental values indicate a decrease in social costs of GHGs, while positive incremental values indicate an increase in costs relative to the baseline for the given model year. The GHG costs follow a similar pattern in all three

alternatives, decreasing across all model years, with the largest reductions associated with 2026–2029 model years. The magnitude of CO₂ emissions is much higher than the magnitudes of CH₄ and N₂O emissions, which is why the total costs are so much larger for CO₂.

Table V-57 – Total and Incremental Costs of GHGs (2018\$, billions), MY 1981-2029, 3 Percent Discount Rate, by Alternative

Model Year:	1981 - 2023	2024	2025	2026	2027	2028	2029	Total
Alternative 0 (Totals)								
CO ₂	822.63	59.54	56.96	54.87	53.72	52.33	50.83	1,150.90
CH ₄	33.66	2.53	2.43	2.36	2.33	2.29	2.24	47.84
N ₂ O	12.03	0.76	0.73	0.70	0.69	0.67	0.66	16.22
Alternative 1 (Relative to Alternative 0)								
CO ₂	0.16	-1.70	-2.05	-2.44	-2.54	-2.63	-2.52	-13.73
CH ₄	0.01	-0.07	-0.08	-0.10	-0.10	-0.11	-0.11	-0.56
N ₂ O	0.00	-0.02	-0.02	-0.02	-0.03	-0.03	-0.03	-0.14
Alternative 2 (Relative to Alternative 0)								
CO ₂	0.59	-2.30	-3.28	-4.53	-4.68	-4.73	-4.49	-23.43
CH ₄	0.03	-0.09	-0.13	-0.18	-0.19	-0.19	-0.18	-0.93
N ₂ O	0.01	-0.03	-0.04	-0.05	-0.05	-0.05	-0.05	-0.25
Alternative 2.5 (Relative to Alternative 0)								
CO ₂	0.73	-2.54	-3.54	-5.13	-5.28	-5.35	-5.08	-26.20
CH ₄	0.04	-0.10	-0.14	-0.21	-0.21	-0.22	-0.21	-1.04
N ₂ O	0.01	-0.03	-0.04	-0.05	-0.06	-0.06	-0.06	-0.28
Alternative 3 (Relative to Alternative 0)								
CO ₂	1.10	-3.54	-4.78	-6.38	-6.55	-6.66	-6.30	-33.11
CH ₄	0.05	-0.14	-0.19	-0.25	-0.26	-0.27	-0.25	-1.31
N ₂ O	0.02	-0.04	-0.05	-0.07	-0.07	-0.07	-0.07	-0.35

Table V-58 – Total and Incremental Costs of GHGs (2018\$, billions), MY 1981-2029, 5 Percent Discount Rate, by Alternative

Model Year:	1981 - 2023	2024	2025	2026	2027	2028	2029	Total
Alternative 0 (Totals)								
CO ₂	221.44	15.42	14.63	13.93	13.52	13.04	12.57	304.53
CH ₄	14.00	0.99	0.94	0.90	0.88	0.85	0.82	19.39
N ₂ O	3.59	0.21	0.20	0.19	0.19	0.18	0.18	4.75
Alternative 1 (Relative to Alternative 0)								
CO ₂	0.04	-0.44	-0.53	-0.62	-0.64	-0.66	-0.62	-3.47
CH ₄	0.00	-0.03	-0.03	-0.04	-0.04	-0.04	-0.04	-0.21
N ₂ O	0.00	-0.01	-0.01	-0.01	-0.01	-0.01	-0.01	-0.04
Alternative 2 (Relative to Alternative 0)								
CO ₂	0.15	-0.60	-0.84	-1.15	-1.18	-1.18	-1.11	-5.92
CH ₄	0.01	-0.04	-0.05	-0.07	-0.07	-0.07	-0.07	-0.35
N ₂ O	0.00	-0.01	-0.01	-0.01	-0.01	-0.01	-0.01	-0.07
Alternative 2.5 (Relative to Alternative 0)								
CO ₂	0.19	-0.66	-0.91	-1.31	-1.33	-1.33	-1.26	-6.61
CH ₄	0.01	-0.04	-0.05	-0.08	-0.08	-0.08	-0.08	-0.39
N ₂ O	0.00	-0.01	-0.01	-0.02	-0.02	-0.02	-0.01	-0.08
Alternative 3 (Relative to Alternative 0)								
CO ₂	0.29	-0.92	-1.23	-1.62	-1.65	-1.66	-1.56	-8.36
CH ₄	0.02	-0.05	-0.07	-0.10	-0.10	-0.10	-0.09	-0.49
N ₂ O	0.01	-0.01	-0.01	-0.02	-0.02	-0.02	-0.02	-0.10

Table V-59 – Total and Incremental Costs of GHGs (2018\$, billions), MY 1981-2029, 95th percentile at 3 Percent Discount Rate, by Alternative

Model Year:	1981 - 2023	2024	2025	2026	2027	2028	2029	Total
Alternative 0 (Totals)								
CO ₂	2,479.92	180.54	172.87	166.67	163.24	159.34	155.02	3,477.60
CH ₄	88.96	6.69	6.46	6.28	6.19	6.08	5.97	126.63
N ₂ O	31.81	2.01	1.93	1.86	1.83	1.78	1.74	42.97
Alternative 1 (Relative to Alternative 0)								
CO ₂	0.48	-5.17	-6.22	-7.42	-7.73	-8.00	-7.67	-41.73
CH ₄	0.02	-0.18	-0.22	-0.27	-0.28	-0.29	-0.28	-1.49
N ₂ O	0.01	-0.05	-0.06	-0.07	-0.07	-0.07	-0.07	-0.36
Alternative 2 (Relative to Alternative 0)								
CO ₂	1.78	-6.97	-9.96	-13.77	-14.23	-14.41	-13.68	-71.23
CH ₄	0.08	-0.24	-0.35	-0.48	-0.50	-0.51	-0.49	-2.48
N ₂ O	0.03	-0.07	-0.09	-0.13	-0.13	-0.13	-0.13	-0.65
Alternative 2.5 (Relative to Alternative 0)								
CO ₂	2.21	-7.70	-10.75	-15.59	-16.05	-16.28	-15.49	-79.65
CH ₄	0.10	-0.26	-0.37	-0.54	-0.56	-0.57	-0.55	-2.77
N ₂ O	0.04	-0.07	-0.10	-0.15	-0.15	-0.15	-0.15	-0.73
Alternative 3 (Relative to Alternative 0)								
CO ₂	3.32	-10.72	-14.49	-19.38	-19.89	-20.27	-19.22	-100.65
CH ₄	0.14	-0.37	-0.50	-0.67	-0.69	-0.71	-0.68	-3.47
N ₂ O	0.05	-0.10	-0.14	-0.18	-0.19	-0.19	-0.19	-0.94

The CAFE Model calculates health costs attributed to criteria pollutant emissions of NO_x, SO_x, and PM_{2.5}, shown in Table V-60 and Table V-61. These costs are directly related to the tons of each pollutant emitted from various upstream and downstream sources, including on-road vehicles, electricity generation, fuel refining, and fuel transportation and distribution. See Chapter 4 of the Final SEIS and Chapter 5.4 of the TSD for further information regarding the calculations used to estimate health impacts, and more details about the types of health effects.

The following section of the preamble, Section V.D, discusses the changes in tons of emissions themselves across rulemaking alternatives, while the current section focuses on the changes in social costs associated with those emissions.

Criteria pollutant health costs (presented in Table V-60 and Table V-61) increase slightly in earlier model years (1981-2023), but those cost increases are offset by the decrease in health costs in later model years. In Table V-60 and Table V-61, the costs in Alternatives 1 through 3 are shown in

incremental terms relative to Alternative 0. The changes across alternatives relative to the baseline are relatively minor, although some impacts in later model years are more significant (*e.g.*, the decreases in PM_{2.5} in 2028 under Alternative 3). Since the health cost value per ton of emissions differs by pollutant, the pollutants that incur the highest costs are not necessarily those with the largest amount of emissions (see Section V.D for discussion of physical effects).

**Table V-60 – Total and Incremental Health Costs of Criteria Pollutants (2018\$, billions),
MY 1981-2029, 3 Percent Discount Rate, by Alternative**

Model Year:	1981 - 2023	2024	2025	2026	2027	2028	2029	Total
Alternative 0 (Totals)								
NO _x	74.67	0.96	0.88	0.85	0.82	0.79	0.76	79.73
SO _x	68.02	4.45	4.21	4.01	3.87	3.71	3.57	91.84
PM _{2.5}	207.00	5.88	5.58	5.34	5.18	5.00	4.82	238.78
Alternative 1 (Relative to Alternative 0)								
NO _x	0.07	-0.01	-0.02	-0.02	-0.02	-0.02	-0.02	-0.04
SO _x	0.05	-0.07	-0.09	-0.11	-0.10	-0.11	-0.10	-0.54
PM _{2.5}	0.17	-0.11	-0.12	-0.15	-0.15	-0.15	-0.14	-0.64
Alternative 2 (Relative to Alternative 0)								
NO _x	0.17	-0.01	-0.02	-0.03	-0.03	-0.03	-0.03	0.03
SO _x	0.15	-0.05	-0.10	-0.14	-0.13	-0.13	-0.12	-0.53
PM _{2.5}	0.42	-0.14	-0.20	-0.27	-0.27	-0.27	-0.26	-0.99
Alternative 2.5 (Relative to Alternative 0)								
NO _x	0.19	-0.01	-0.02	-0.03	-0.03	-0.03	-0.03	0.05
SO _x	0.17	-0.06	-0.11	-0.14	-0.12	-0.13	-0.12	-0.52
PM _{2.5}	0.49	-0.15	-0.21	-0.30	-0.30	-0.30	-0.29	-1.08
Alternative 3 (Relative to Alternative 0)								
NO _x	0.25	-0.02	-0.02	-0.03	-0.03	-0.03	-0.03	0.10
SO _x	0.20	-0.09	-0.10	-0.14	-0.12	-0.12	-0.12	-0.50
PM _{2.5}	0.67	-0.22	-0.29	-0.38	-0.38	-0.38	-0.36	-1.32

**Table V-61 – Total and Incremental Health Costs of Criteria Pollutants (2018\$, billions),
MY 1981-2029, 7 Percent Discount Rate, by Alternative**

Model Year:	1981 - 2023	2024	2025	2026	2027	2028	2029	Total
Alternative 0 (Totals)								
NO _x	57.03	0.60	0.53	0.49	0.46	0.42	0.39	59.91
SO _x	50.29	2.79	2.55	2.34	2.17	2.01	1.86	64.00
PM _{2.5}	152.64	3.61	3.30	3.05	2.84	2.65	2.45	170.55
Alternative 1 (Relative to Alternative 0)								
NO _x	0.04	-0.01	-0.01	-0.01	-0.01	-0.01	-0.01	-0.02
SO _x	0.03	-0.04	-0.06	-0.06	-0.06	-0.06	-0.05	-0.30
PM _{2.5}	0.11	-0.07	-0.08	-0.09	-0.08	-0.08	-0.07	-0.36
Alternative 2 (Relative to Alternative 0)								
NO _x	0.11	-0.01	-0.01	-0.02	-0.01	-0.01	-0.01	0.03
SO _x	0.10	-0.03	-0.06	-0.08	-0.07	-0.07	-0.06	-0.28
PM _{2.5}	0.27	-0.09	-0.12	-0.16	-0.15	-0.15	-0.13	-0.54
Alternative 2.5 (Relative to Alternative 0)								
NO _x	0.12	-0.01	-0.01	-0.02	-0.01	-0.01	-0.01	0.05
SO _x	0.11	-0.04	-0.07	-0.08	-0.07	-0.07	-0.06	-0.27
PM _{2.5}	0.31	-0.10	-0.13	-0.18	-0.17	-0.17	-0.15	-0.59
Alternative 3 (Relative to Alternative 0)								
NO _x	0.16	-0.01	-0.01	-0.02	-0.01	-0.01	-0.01	0.08
SO _x	0.13	-0.06	-0.06	-0.08	-0.07	-0.06	-0.06	-0.26
PM _{2.5}	0.42	-0.14	-0.17	-0.22	-0.21	-0.20	-0.19	-0.72

NHTSA estimates social costs of congestion and noise across regulatory alternatives, throughout the lifetimes of MYs 1981–2029. Congestion and noise are functions of VMT and fleet mix, and the differences between alternatives are due mainly to differences in VMT (see Section V.D). Overall, congestion and

noise costs increase relative to the baseline across all alternatives, but viewed from a model year perspective, the congestion and noise costs in some model years, particularly in Alternatives 2.5 and 3, are negative relative to Alternative 0. It is important to note that the overall increases in congestion and

noise costs are relatively small when compared to the total congestion and noise costs in Alternative 0. For further details regarding congestion and noise costs, see Chapter 6.2.3 of the TSD and Chapter 6.5 of the FRIA.

Table V-62 – Total and Incremental Congestion and Noise Costs (2018\$, billions), MY 1981-2029, 3 Percent Discount Rate, by Alternative⁷⁸⁴

Model Year:	1981 - 2023	2024	2025	2026	2027	2028	2029	Total
Alternative 0/Baseline (Totals)								
Congestion	4141.26	344.55	328.52	317.14	306.79	295.87	285.10	6019.22
Noise	29.44	2.44	2.33	2.25	2.17	2.10	2.02	42.74
Alternative 1 (Relative to Alternative 0)								
Congestion	3.12	0.02	0.19	0.39	0.67	0.79	0.88	6.06
Noise	0.02	0.00	0.00	0.00	0.01	0.01	0.01	0.05
Alternative 2 (Relative to Alternative 0)								
Congestion	7.10	0.07	0.08	0.04	0.55	0.85	1.01	9.70
Noise	0.05	0.00	0.00	0.00	0.00	0.01	0.01	0.07
Alternative 2.5 (Relative to Alternative 0)								
Congestion	8.23	0.13	0.16	-0.10	0.47	0.81	1.01	10.72
Noise	0.06	0.00	0.00	0.00	0.00	0.01	0.01	0.08
Alternative 3 (Relative to Alternative 0)								
Congestion	11.17	0.05	-0.19	-0.38	0.35	0.78	1.08	12.86
Noise	0.08	0.00	0.00	0.00	0.00	0.01	0.01	0.10

Table V-63 – Total and Incremental Congestion and Noise Costs (2018\$, billions), MY 2020-2029, 7 Percent Discount Rate, by Alternative

Model Year:	1981 - 2023	2024	2025	2026	2027	2028	2029	Total
Alternative 0/Baseline (Totals)								
Congestion	3396.44	241.29	221.48	205.82	191.65	177.93	165.06	4599.67
Noise	24.13	1.71	1.57	1.46	1.36	1.26	1.17	32.65
Alternative 1 (Relative to Alternative 0)								
Congestion	2.22	0.00	0.10	0.22	0.39	0.45	0.49	3.87
Noise	0.02	0.00	0.00	0.00	0.00	0.00	0.00	0.03
Alternative 2 (Relative to Alternative 0)								
Congestion	4.98	0.01	0.00	-0.03	0.30	0.48	0.56	6.30
Noise	0.04	0.00	0.00	0.00	0.00	0.00	0.00	0.05
Alternative 2.5 (Relative to Alternative 0)								
Congestion	5.77	0.05	0.05	-0.12	0.25	0.45	0.56	7.00
Noise	0.04	0.00	0.00	0.00	0.00	0.00	0.00	0.05
Alternative 3 (Relative to Alternative 0)								
Congestion	7.83	-0.02	-0.21	-0.32	0.15	0.43	0.59	8.46
Noise	0.06	0.00	0.00	0.00	0.00	0.00	0.00	0.06

⁷⁸⁴ The values in the following tables have been rounded to two significant figures.

The CAFE Model accounts for benefits of increased energy security by computing changes in social costs of petroleum market externalities. These social costs represent the risk to the U.S. economy incurred by exposure to price shocks in the global petroleum market that are not accounted for by oil prices and are a direct function of gallons of fuel consumed. The computation does not include other potential benefits, including the reduction in impact to

consumers of large swings in gasoline prices that can occur as a result of global unrest and other shocks to the petroleum market. These swings can be very difficult for consumers, especially low-income consumers, to bear. Reducing reliance on energy through more stringent fuel economy standards provides a direct benefit to consumers. Chapter 6.2.4 of the accompanying TSD describes the inputs involved in calculating these petroleum market

externality costs. Petroleum market externality costs decrease relative to the baseline under all alternatives, regardless of the discount rate used. This pattern occurs due to the decrease in gallons of fuel consumed (see Section V.D) as the stringency of alternatives increases. Only the earlier model year cohorts (1981–2023) contribute to slight increases in petroleum market externality costs, but these are offset by the decreases from later model years.

Table V-64 – Total and Incremental Petroleum Market Externalities Costs (2018\$, billions), MY 1981-2029, by Alternative

Model Year:	1981-2020	2021-2023	2024-2026	2027-2029
Discount rate	Alternative 0 (Totals)			
3%	36.1	3.9	3.6	3.3
7%	29.6	2.9	2.4	2.0
	Alternative 1 (Relative to Alternative 0)			
3%	0.03	0.00	-0.11	-0.17
7%	0.02	0.00	-0.07	-0.10
	Alternative 2 (Relative to Alternative 0)			
3%	0.08	0.01	-0.15	-0.31
7%	0.06	0.00	-0.10	-0.19
	Alternative 2.5 (Relative to Alternative 0)			
3%	0.09	0.01	-0.17	-0.35
7%	0.06	0.00	-0.11	-0.22
	Alternative 3 (Relative to Alternative 0)			
3%	0.12	0.01	-0.23	-0.44
7%	0.09	0.01	-0.16	-0.27

NHTSA estimates various monetized safety impacts across regulatory alternatives, including costs of fatalities, non-fatal crash costs, and property

damage costs. Table V–65 presents the changes in these social costs across alternatives and discount rates. Safety effects are discussed at length in the

FRIA accompanying this notice (see Chapter 5 of the FRIA).

Table V-65 – Incremental Social Costs of Safety Impacts (2018\$, billions), MY 1981-2029, by Alternative (Relative to Alternative 0)

	Alternative 1		Alternative 2		Alternative 2.5		Alternative 3	
	3%	7%	3%	7%	3%	7%	3%	7%
Fatality Costs	4.9	3.2	9.2	6.1	10.2	6.8	13.1	8.8
Non-Fatal Crash Costs	3.8	2.5	6.3	4.2	6.9	4.6	8.7	5.9
Property Damage Crash Costs	0.8	0.5	1.2	0.8	1.4	0.9	1.7	1.2

D. Physical and Environmental Effects

NHTSA calculates estimates for the various physical and environmental effects associated with the new standards. These include quantities of

fuel and electricity consumption, tons of greenhouse gas (GHG) emissions and criteria pollutants reduced, and health and safety impacts.

In terms of fuel and electricity usage, NHTSA estimates that the new standards could save about 60 billion gallons of gasoline and increase electricity consumption by about 180

TWh over the lives of vehicles produced prior to MY 2030, relative to the baseline standards (i.e., the No-Action Alternative). From a calendar year perspective, NHTSA's analysis also estimates total annual consumption of

fuel by the entire on-road fleet from calendar year 2020 through calendar year 2050. On this basis, gasoline and electricity consumption by the U.S. light-duty vehicle fleet evolves as shown in the following two graphs, each

of which shows projections for the No-Action Alternative (Alternative 0, i.e., the baseline), Alternative 1, Alternative 2, Alternative 2.5 (the final standards), and Alternative 3.

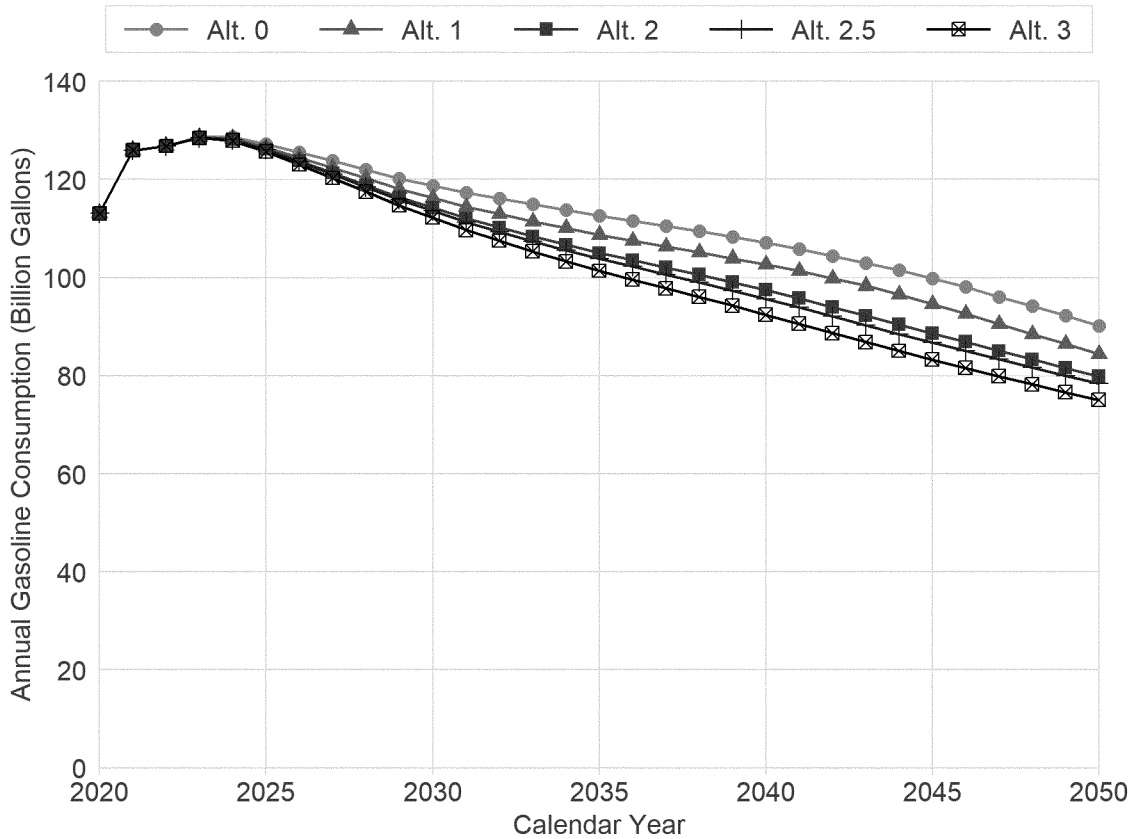

Figure V-5 – Estimated Annual Gasoline Consumption by Light-Duty On-Road Fleet

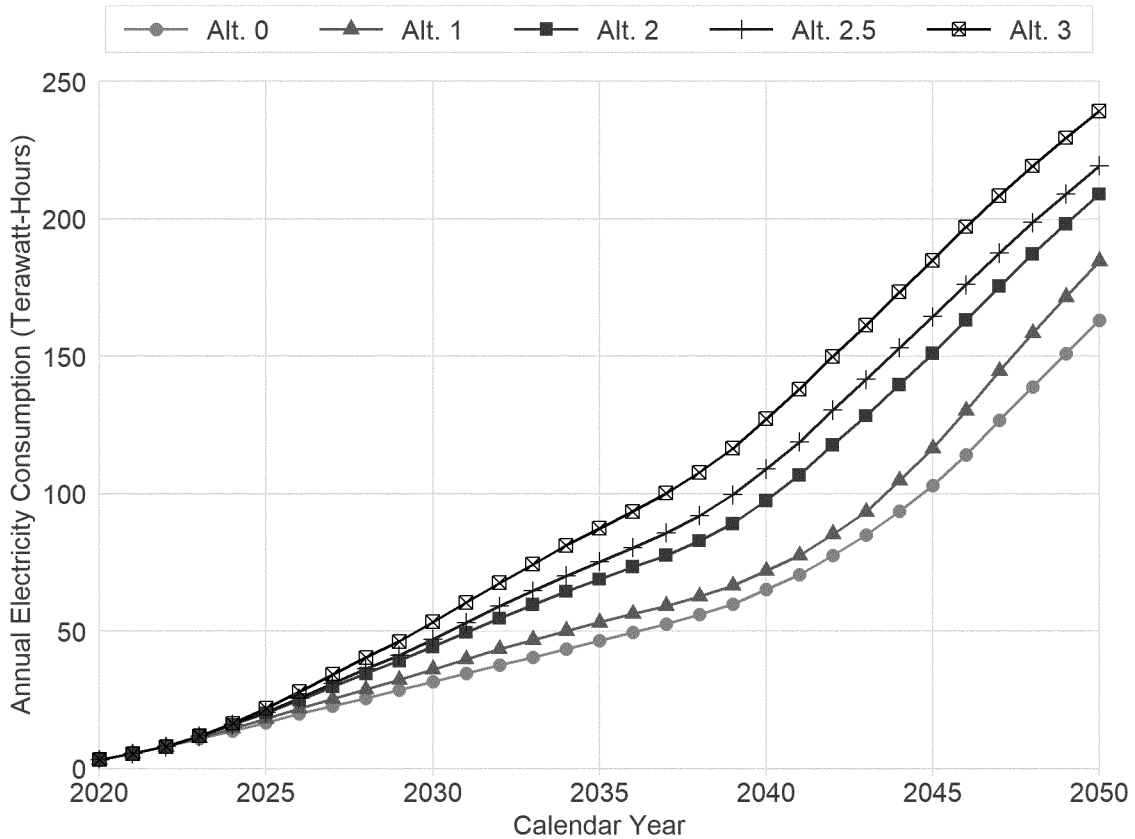

Figure V-6 – Estimated Electricity Consumption by Light-Duty On-Road Fleet

NHTSA estimates the greenhouse gas emissions (GHGs) attributable to the light-duty on-road fleet, from both vehicles and upstream energy sector processes (e.g., petroleum refining, fuel transportation and distribution, electricity generation). Overall, NHTSA estimates that the revised standards

could reduce greenhouse gases by about 605 million metric tons of carbon dioxide (CO₂), about 730 thousand metric tons of methane (CH₄), and about 17 thousand metric tons of N₂O. The following three graphs (Figure V-7, Figure V-8, and Figure V-9) present NHTSA’s estimate of how emissions

from these three GHGs could evolve over the years. Note that these graphs include emissions from both vehicle and upstream processes. All three GHG emissions follow similar trends in the years between 2020–2050.

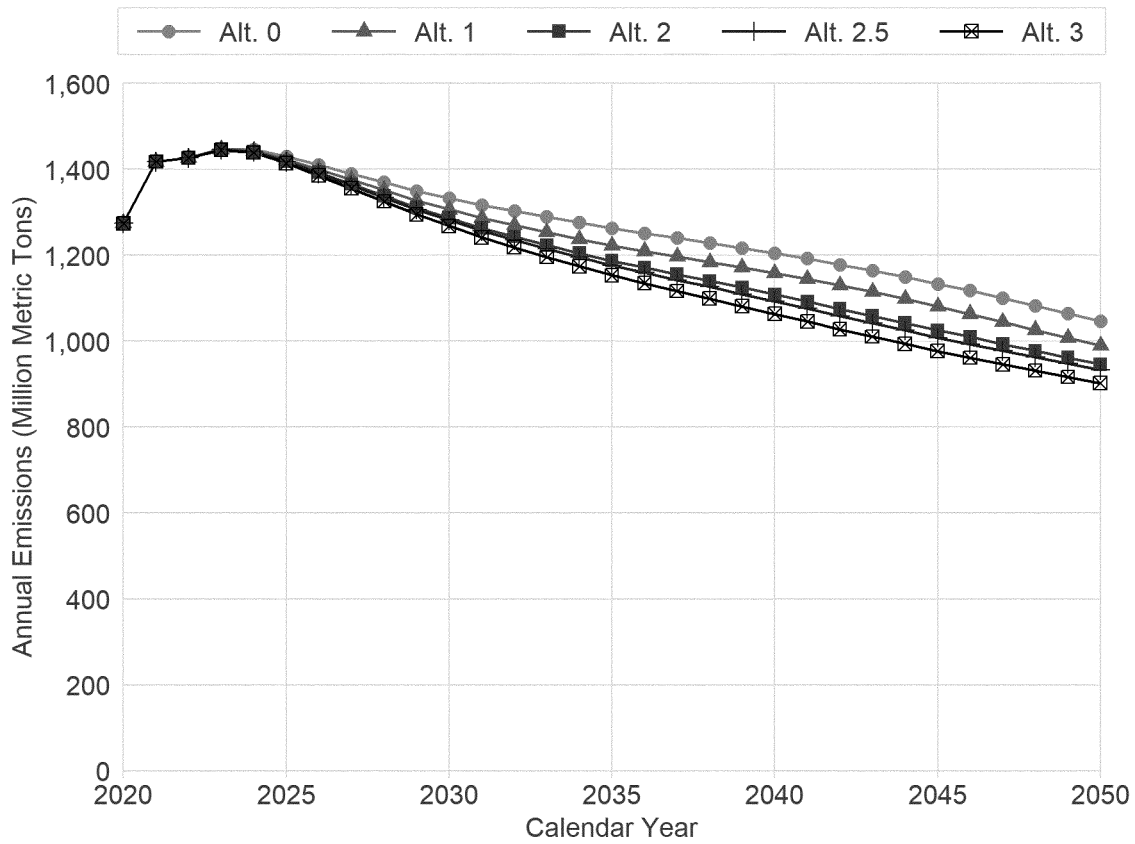

Figure V-7 – Estimated Annual CO₂ Emissions Attributable to Light-Duty On-Road Fleet

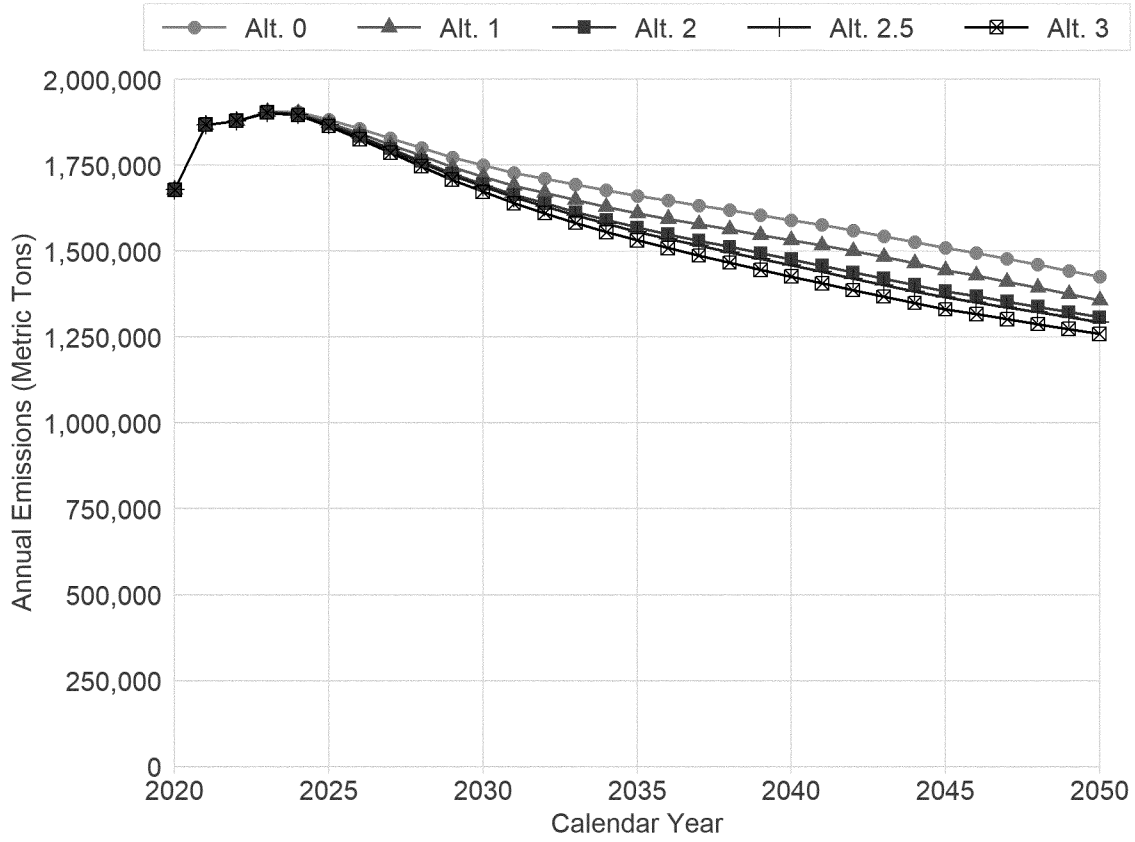

Figure V-8 – Estimated Annual CH4 Emissions Attributable to Light-Duty On-Road Fleet

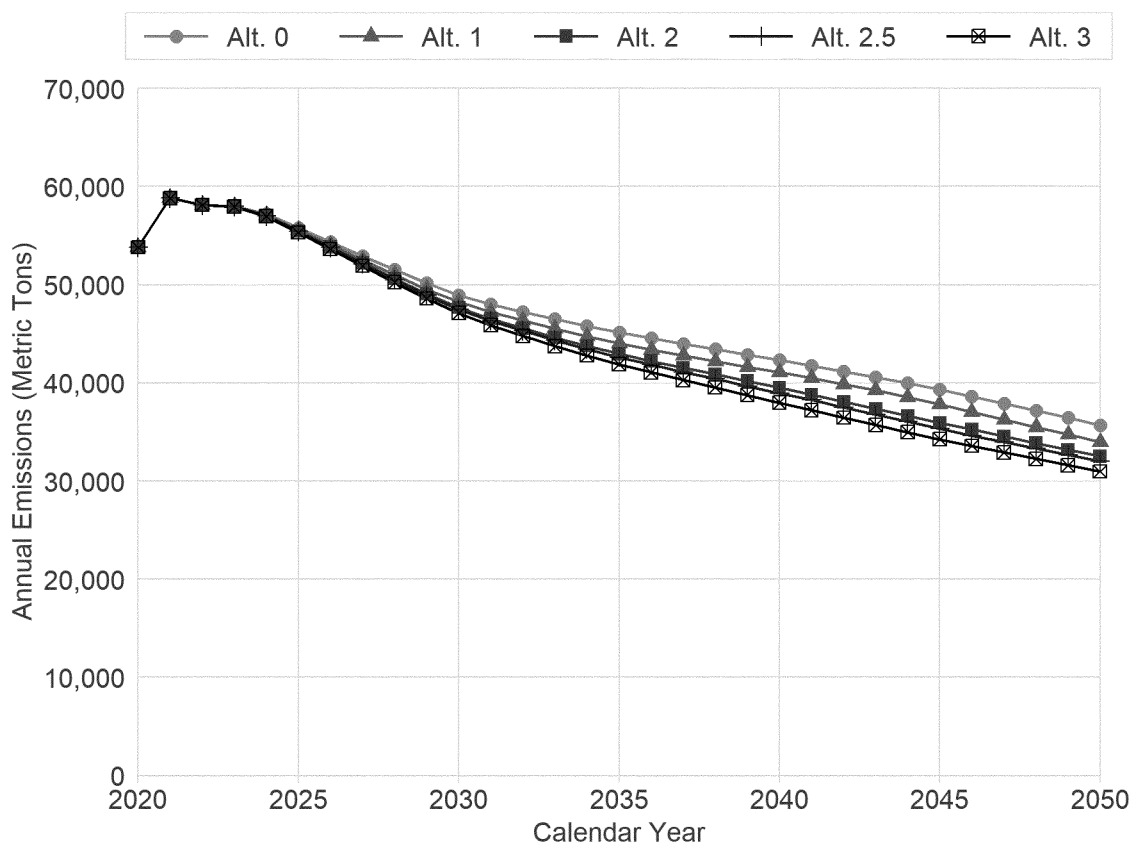

Figure V-9 – Estimated Annual N₂O Emissions Attributable to Light-Duty On-Road Fleet

The figures presented here are not the only estimates NHTSA has calculated regarding projected GHG emissions in future years. As discussed in Section II, the accompanying Final SEIS uses an “unconstrained” analysis as opposed to the “standard setting” analysis presented in this final rule and FRIA. For more information regarding projected GHG emissions, as well as model-based estimates of corresponding impacts on several measures of global climate change, see the Final SEIS.

NHTSA also estimates criteria pollutant emissions resulting from vehicle and upstream processes attributable to the light-duty on-road fleet. NHTSA includes estimates for all

of the criteria pollutants for which EPA has issued National Ambient Air Quality Standards. Under each regulatory alternative, NHTSA projects a dramatic decline in annual emissions of carbon monoxide (CO), volatile organic compounds (VOC), nitrogen oxide (NO_x), and fine particulate matter (PM_{2.5}) attributable to the light-duty on-road fleet between 2020 and 2050. As exemplified in Figure V-10, emissions in any given year could be very nearly the same under each regulatory alternative.

On the other hand, as discussed in the FRIA and Final SEIS accompanying this notice, NHTSA projects that annual SO₂ emissions attributable to the light-duty

on-road fleet could increase modestly under the action alternatives, because, as discussed above, NHTSA projects that each of the action alternatives could lead to greater use of electricity (for PHEVs and BEVs). The adoption of actions—such as actions prompted by President Biden’s Executive orders regarding Federal clean electricity, vehicle procurement, and sustainability—to reduce electricity generation emission rates beyond projections underlying NHTSA’s analysis (discussed in the TSD) could dramatically reduce SO₂ emissions under all regulatory alternatives considered here.⁷⁸⁵

⁷⁸⁵ See <https://www.whitehouse.gov/briefing-room/presidential-actions/2021/01/27/executive-order-on-tackling-the-climate-crisis-at-home-and->

[abroad/](https://www.whitehouse.gov/briefing-room/presidential-actions/2021/12/08/executive-order-on-catalyzing-), accessed June 17, 2021. See also <https://www.whitehouse.gov/briefing-room/presidential-actions/2021/12/08/executive-order-on-catalyzing->

[clean-energy-industries-and-jobs-through-federal-sustainability/](https://www.whitehouse.gov/briefing-room/presidential-actions/2021/12/08/executive-order-on-catalyzing-clean-energy-industries-and-jobs-through-federal-sustainability/), accessed January 18, 2022.

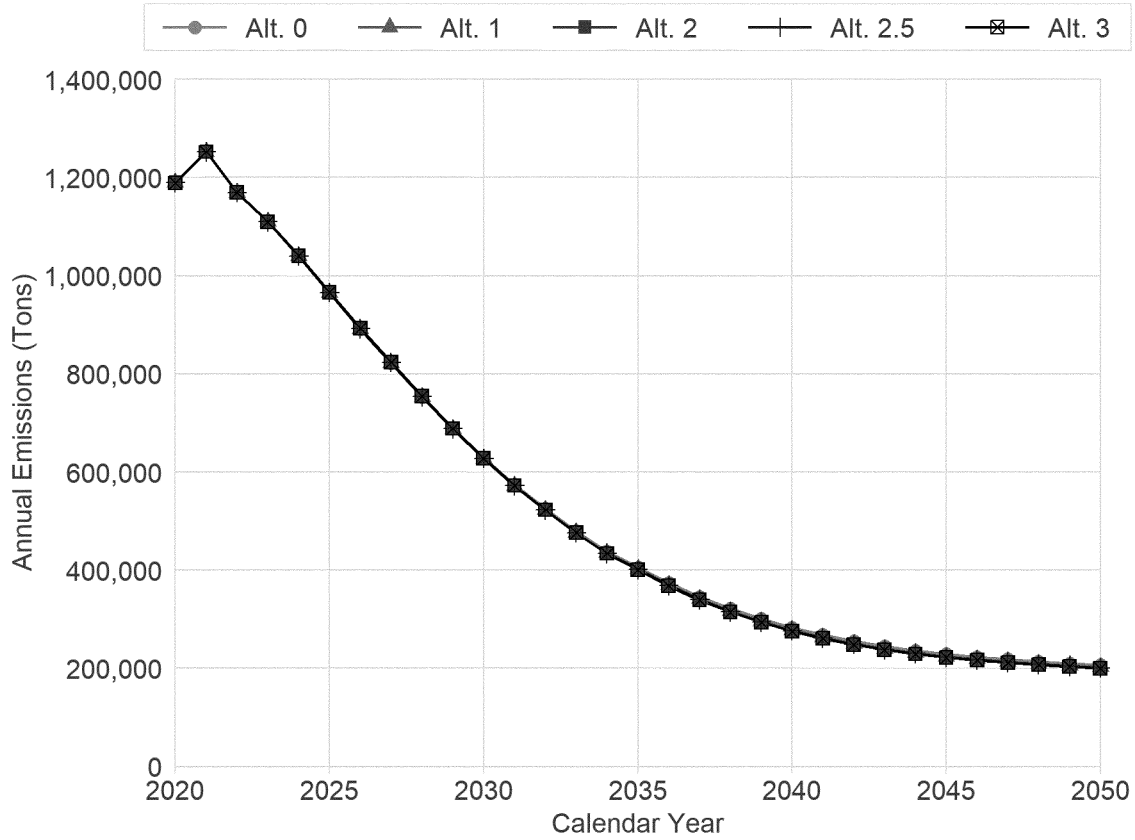

Figure V-10 – Estimated Annual NO_x Emissions Attributable to Light-Duty On-Road Fleet

The following two figures show NHTSA’s estimates of the projected decreases in PM_{2.5} emissions and slight increases in SO₂ emissions, for all

alternatives and between years 2020–2050. The differences in SO₂ emissions across alternatives are due mainly to the various projections of electricity usage

shown in Figure V–6. See Chapter 6.6 of the FRIA for a detailed discussion of changes in criteria pollutant emissions in the different alternatives.

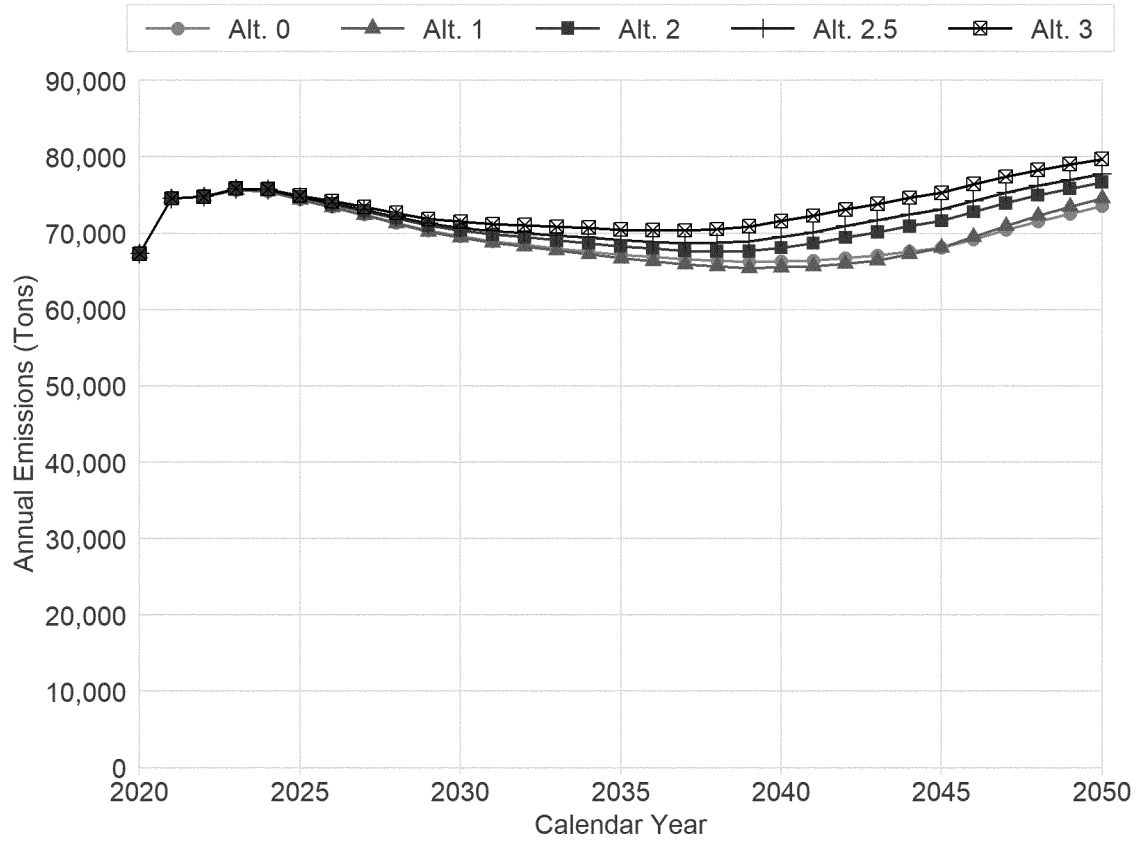

Figure V-11 – Estimated Annual SO₂ Emissions Attributable to Light-Duty On-Road Fleet

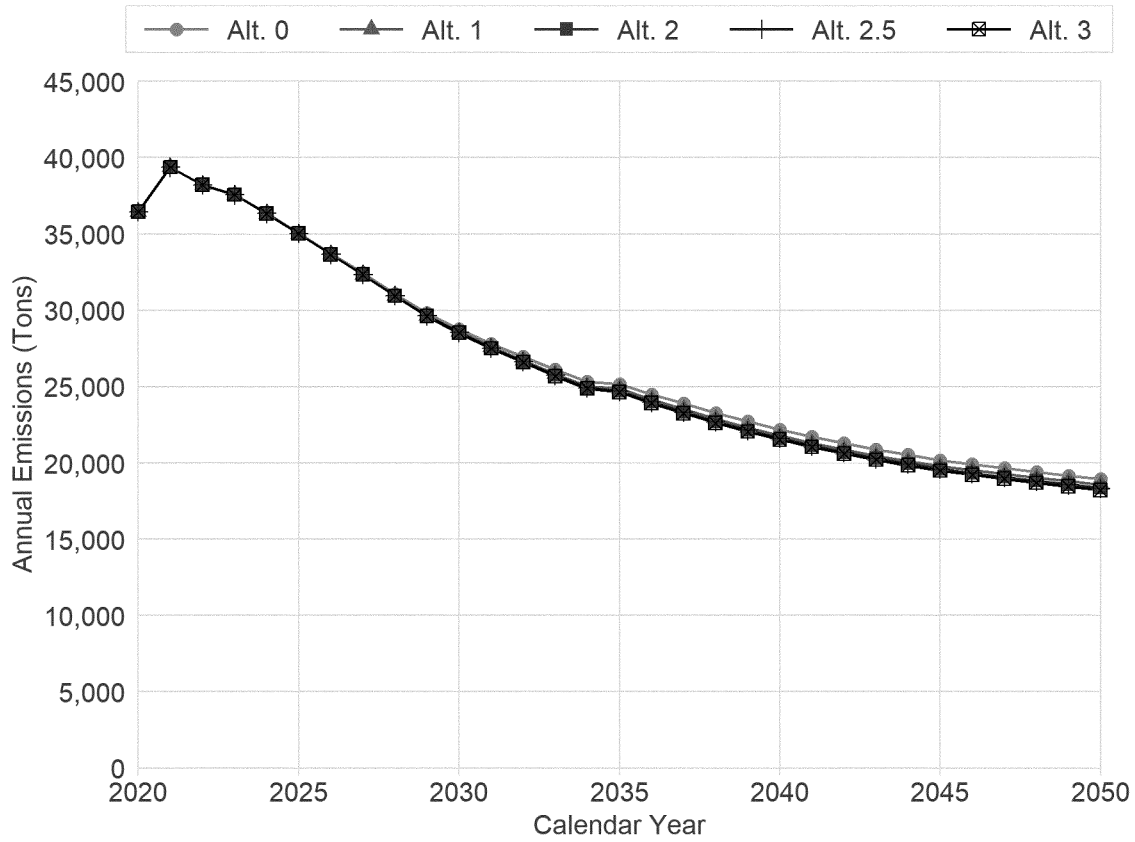

Figure V-12 – Estimated Annual PM_{2.5} Emissions Attributable to Light-Duty On-Road Fleet

Health impacts quantified by the CAFE Model include various instances of hospital visits due to respiratory problems, minor restricted activity days, non-fatal heart attacks, acute bronchitis, premature mortality, and other effects of criteria pollutant emissions on health.

Figure V-13 shows the differences in select health impacts relative to the baseline, across Alternatives 1 through 3. These changes are split between calendar year decades, with the largest differences between the baseline and alternatives occurring between 2041–

2050. The magnitude of the differences relates directly to the changes in tons of criteria pollutants emitted. See Chapter 5.4 of the TSD for information regarding how the CAFE Model calculates these health impacts.



Figure V-13 – Changes in Cumulative Emission Health Impacts Relative to the Baseline

Lastly, NHTSA also quantifies safety impacts in its analysis. These include estimated counts of fatalities, non-fatal injuries, and property damage crashes occurring over the lifetimes of the light-duty on-road vehicles considered in the analysis. Chapter 5 of the FRIA accompanying this notice contains an in-depth discussion on the effects of the various alternatives on these safety measures, and TSD Chapter 7 contains information regarding the construction of the safety estimates.

E. Sensitivity Analysis

The analysis conducted to support this rule consists of data, estimates, and assumptions, all applied within an analytical framework, the CAFE Model. Just like in all past CAFE rulemakings, NHTSA recognizes that many analytical

inputs are uncertain, and some inputs are very uncertain. Of those uncertain inputs, some are likely to exert considerable influence over specific types of estimated impacts, and some are likely to do so for the bulk of the analysis. Yet making assumptions in the face of that uncertainty is necessary when analyzing possible future events (e.g., consumer and industry responses to fuel efficiency regulation). To better understand the effect that these assumptions have on the analytical findings, we conducted additional model runs with alternative assumptions. These additional runs were specified in an effort to explore a range of potential inputs and the sensitivity of estimated impacts to changes in model inputs. Sensitivity cases in this analysis span assumptions

related to technology applicability and cost, economic conditions, consumer preferences, externality values, and safety assumptions, among others.⁷⁸⁶ A sensitivity analysis can identify two critical pieces of information: *How big an influence* does each parameter exert on the analysis, and *how sensitive are the model results* to that assumption?

That said, influence is different from likelihood. NHTSA does not mean to suggest that any one of the sensitivity cases presented here is inherently more likely than the collection of

⁷⁸⁶ In contrast to an uncertainty analysis, where many assumptions are varied simultaneously, the sensitivity analyses included here vary a single assumption and provide information about the influence of each individual factor, rather than suggesting that an alternative assumption would have justified a different Preferred Alternative.

assumptions that represent the reference case in the figures and tables that follow. Nor is this sensitivity analysis intended to suggest that only one of the many assumptions made is likely to prove off-base with the passage of time or new observations. It is more likely that, when assumptions are eventually contradicted by future observation (*e.g.*,

deviations in observed and predicted fuel prices are nearly a given), there will be collections of assumptions, rather than individual parameters, that simultaneously require updating. For this reason, we do not interpret the sensitivity analysis as necessarily providing justification for alternative regulatory scenarios to be preferred.

Rather, the analysis simply provides an indication of which assumptions are most critical, and the extent to which future deviations from central analysis assumptions could affect costs and benefits of the rule.

Table V-66 lists and briefly describes the cases that we examined in the sensitivity analysis.

Table V-66 – Cases Included in Sensitivity Analysis

Sensitivity Case	Description
RC	Reference case
EIS-RC	Reference case for Environmental Impact Statement
MR5/6 skip (>100k)	MR5 and MR6 skipped for platforms with 100k or more units
MR5/6 skip (>2k)	MR5 and MR6 skipped for platforms with 2k or more units
No MR5/6 skip	No “SKIP” entries preventing application of MR5 or MR6 to specific platforms
2020 Final Rule MR5/6 costs	Cost values for MR5 and MR6 at levels from 2020 Final Rule
One-year redesign cadence	Vehicles redesigned every year
Battery direct costs (-20%)	Battery direct manufacturing cost decreased by 20%, battery learning cost at reference case levels
Battery direct costs (+20%)	Battery direct manufacturing cost increased by 20%, battery learning cost at reference case levels
Battery learning rate (-20%)	Year-over-year percentage rate of learning has been decreased by 20%, resulting in higher battery costs than reference levels. Battery direct manufacturing cost at reference case levels
Battery learning rate (+20%)	Year-over-year percentage rate of learning has been increased by 20%, resulting in lower battery costs than reference levels. Battery direct manufacturing cost at reference case levels

Flat AC/OC	No additional AC or OC credit accumulation after MY 2021 levels.
Limited HCR skip	Except for HCR2, HCR engine is applicable for all OEMs and technology classes
Limited conventional tech. improvement	SKIP application of advanced engines and transmissions, and highest levels of AERO and MR
Oil price (EIA AEO 2021 low)	Input oil price series based on EIA low forecast from AEO 2021
Oil price (Global Insight)	Input oil price series based on Global Insight October 2021 forecast
Oil price (EIA AEO 2021 high)	Input oil price series based on EIA high forecast from AEO 2021
No payback period	Payback period eliminated
24-month payback period	Payback period set to 24 months
36-month payback period	Payback period set to 36 months
60-month payback period	Payback period set to 60 months
30-month fuel-savings value (70k miles)	Valuation of fuel savings at 30 months for technology application, 70k miles for sales and scrappage models
Implicit opportunity cost	Includes a measure that estimates possible opportunity cost for forgone vehicle attribute improvements that exceed the reference case 30-month payback period.
Rebound (5%)	Rebound effect set at 5 percent
Rebound (15%)	Rebound effect set at 15 percent
Sales-scrappage response ($\eta = -0.1$)	Sales-scrappage model with price elasticity multiplier = -0.1
Sales-scrappage response ($\eta = -0.5$)	Sales-scrappage model with price elasticity multiplier = -0.5
NPRM sales-scrappage response ($\eta = -1$)	Sales-scrappage model with price elasticity multiplier = -1 (as in the NPRM)
Low GDP	Low economic growth (Global Insight October 2021 pessimistic forecast)
High GDP	High economic growth (Global Insight October 2021 optimistic forecast)
Low GDP (+ fuel prices)	Low economic growth with corresponding gasoline and diesel price forecast (Global Insight October 2021 pessimistic forecast)
High GDP (+ fuel prices)	High economic growth with corresponding gasoline and diesel price forecast (Global Insight October 2021 optimistic forecast)
NPRM macro forecast	Macroeconomic inputs retained at NPRM levels
Alt. DFS model (fixed)	Alternative dynamic fleet share model, with shares fixed across alternatives

Alt. DFS model (varying)	Alternative dynamic fleet share model, with shares varying across alternatives
Mass-size-safety (low)	The lower bound of the 95% CI for all mass-size-safety model coefficients
Mass-size-safety (high)	The upper bound of the 95% CI for all mass-size-safety model coefficients
Crash avoidance (low effectiveness)	Lower-bound estimate of effectiveness of 6 current crash avoidance technologies at avoiding fatal, injury, and property damage
Crash avoidance (high effectiveness)	Upper-bound estimate of effectiveness of 6 current crash avoidance technologies at avoiding fatal, injury, and property damage
Reduced power plant emissions	Upstream emission factors reflecting reduced emissions from electricity generation, consistent with lower future costs for renewables
Lepeule criteria pollutant BPT estimates	Criteria pollutant benefit-per-ton (and health impact per ton) estimates based on Lepeule
No ZEV mandates	Exclude representation of ZEV mandates
Fixed nominal fine rate	CAFE fine rate remains \$14 per 0.1 mpg in nominal dollars (as for NPRM analysis)
Unadjusted MDPCS stringency	MDPCS computed dynamically, using 92% value specified in 49 U.S.C. 32902(b)(4)(B)
EPCA constraints throughout MYs 2023-2029	EPCA “standard setting” constraints on consideration of AFVs and application of compliance credits imposed throughout MYs 2023-2029
No response of domestic crude production	No changes in domestic crude oil extraction in response to changes in domestic refining activity
Constrained PHEV FE compliance values	Limit PHEV fuel efficiency compliance ratings for compliance calculations in MYs 2024-2026

Complete results for the sensitivity cases are summarized in Chapter 7 of the accompanying FRIA, and detailed model inputs and outputs for curious

readers are available on NHTSA’s website.⁷⁸⁷ For purposes of this preamble, Figure V–14 below illustrates the relative change of the sensitivity

effect of selected inputs on the costs and benefits estimated for this final rule.

⁷⁸⁷ <https://www.nhtsa.gov/laws-regulations/corporate-average-fuel-economy>.

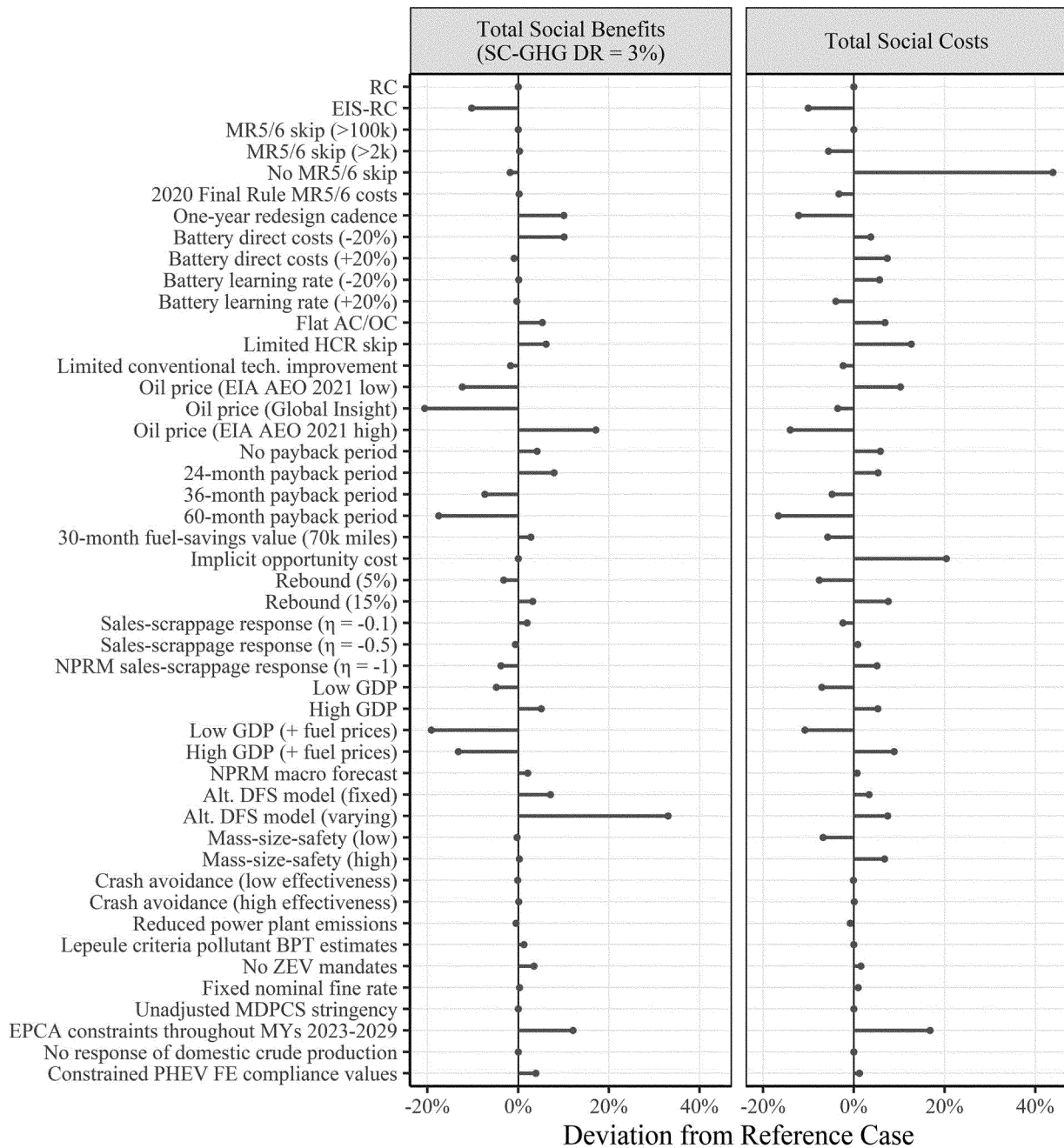

Figure V-14 – Relative Change in Total Costs and Total Benefits from Reference Case

While Figure V-14 does not show precise values, it gives us a sense of which inputs are ones for which a different assumption would have a much different effect on analytical findings, and which ones would not have much effect. Assuming a different oil price trajectory would have a relatively large effect, as would doubling the assumed “payback period.” Making very high levels of mass reduction available to all vehicles

in the modeling appears to have a (relatively) very large effect on costs, but this is to some extent an artifact of the “standard setting” runs used for the preamble and FRIA analysis, where electrification is limited due to statutory restrictions (*i.e.*, high levels of mass reduction are being applied more widely in instances when electrification limits are reached). On the other hand, assumptions about which there has been significant disagreement in the past, like

the rebound effect or the sales-scrappage response, appear to cause only relatively small changes in net benefits across the range of analyzed input values. Chapter 7 of the FRIA provides a much fuller discussion of these findings, and presents net benefits estimated under each of the cases included in the sensitivity analysis, including the subset for which impacts are summarized in Figure V-15.

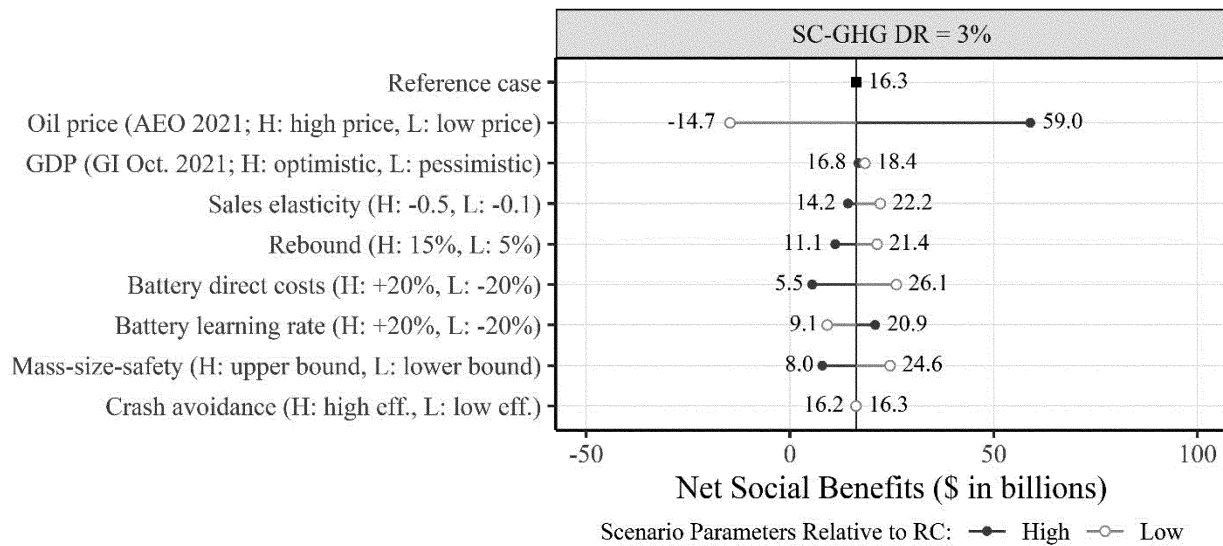

Figure V-15 – Relative Magnitude of Sensitivity Effect on Net Benefits

The results presented in the earlier subsections of Section V and discussed in Section VI reflect the agency’s best judgments regarding many different factors, and the sensitivity analysis discussed here is simply to illustrate the obvious, that differences in assumptions can lead to differences in analytical outcomes, some of which can be large and some of which may be smaller than expected. Policymaking in the face of future uncertainty is inherently complex. Section VI explains how NHTSA balances the statutory factors in light of the analytical findings, the uncertainty that we know exists, and our Nation’s policy goals, to determine the CAFE standards that NHTSA concludes are maximum feasible for MYs 2024–2026.

VI. Basis for NHTSA’s Conclusion That the Final Standards are Maximum Feasible

In this section, NHTSA discusses the factors, data, and analysis that the agency has considered in the selection of the final CAFE standards for MYs 2024–2026. The primary purpose of EPCA, as amended by EISA, and codified at 49 U.S.C. chapter 329, is energy conservation, and fuel economy standards help to conserve energy by requiring automakers to make new vehicles travel a certain distance on a gallon of fuel.⁷⁸⁸ The goal of the CAFE

standards is to conserve energy, while taking into account the statutory factors set forth at 49 U.S.C. 32902(f), as discussed below.

Section 32902(f) of 49 U.S.C. states that when setting maximum feasible CAFE standards for new passenger cars and light trucks, the Secretary of Transportation⁷⁸⁹ “shall consider technological feasibility, economic practicability, the effect of other motor vehicle standards of the Government on fuel economy, and the need of the United States to conserve energy.” In previous rulemakings, including both the 2012 final rule and the recent 2020 final rule, NHTSA considered technological feasibility, including the availability of various fuel-economy-improving technologies to be applied to new vehicles in the timeframe of the standards depending on the ultimate stringency levels, and also considered economic practicability, including the differences between a range of regulatory alternatives in terms of effects on per-vehicle costs, the ability of both the industry and individual manufacturers to comply with standards at various levels, as well as effects on vehicle sales, industry employment, and consumer demand. NHTSA also considered how compliance with other motor vehicle standards of the Government might affect manufacturers’ ability to meet CAFE standards represented by a range of regulatory alternatives, and how the need of the U.S. to conserve energy could be more or less addressed under a range of regulatory alternatives, in terms of

considerations like costs to consumers, the national balance of payments, environmental implications like climate and smog effects, and foreign policy effects such as the likelihood that U.S. military and other expenditures could change as a result of more or less oil consumed by the U.S. vehicle fleet. Besides the factors specified in 32902(f), NHTSA has also historically considered the safety effects of potential CAFE standards, and additionally considers relevant case law. These elements are discussed in detail throughout this analysis.

As will be explained in greater detail below, NHTSA continues to consider all of the same factors in establishing revised CAFE standards for MYs 2024–2026 that it considered in previous rulemakings. Importantly, however, the agency’s balancing of those factors has shifted, and NHTSA is therefore choosing to set CAFE standards at a different level from what both the 2012 final rule and the 2020 final rule set forth. Consideration of public comments and further analysis by the agency has also indicated that the proposed standards were not maximum feasible, and that the selected (more stringent) standards are, in fact, maximum feasible for MYs 2024–2026, as discussed further below.

NHTSA and EPA have coordinated in setting our respective final standards, and many of the factors that NHTSA considers to set maximum feasible standards complement factors that EPA considers under the Clean Air Act. The balancing of different factors by both EPA and NHTSA are consistent with each agency’s statutory authority and

⁷⁸⁸ While individual vehicles need not meet any particular mpg level, as discussed elsewhere in this preamble, fuel economy standards do require vehicle manufacturers’ fleets to meet certain compliance obligations based on fuel economy levels target curves set forth by NHTSA in regulation.

⁷⁸⁹ By delegation, the NHTSA Administrator.

recognize the statutory obligations the Supreme Court pointed to in *Massachusetts v. EPA*. NHTSA also considers the Ninth Circuit's decision in *Center for Biological Diversity v. NHTSA*, which remanded NHTSA's 2006 final rule (71 FR 17566, April 6, 2006) establishing standards for MY 2008–2011 light trucks and underscored that “the overarching purpose of EPCA is energy conservation.”⁷⁹⁰

This final rule contains a range of regulatory alternatives for MYs 2024–2026, from retaining the 1.5 percent annual increases set in 2020, up to a stringency increase of 10 percent annually. The agency evaluated this range of alternatives based on factors relevant to NHTSA's exercise of its 32902(f) authority, such as fuel saved and emissions reduced, the technologies available to meet the standards, the costs of compliance for automakers and their abilities to comply by applying technologies, the impact on consumers with respect to cost, fuel savings, and vehicle choice, and effects on safety, among other things. Several commenters suggested that the agency consider analyzing either more stringent or less stringent alternatives as part of this final rule; those comments are addressed in Section IV.

After consideration of the factors described below and information in the administrative record for this action, including public comments, NHTSA has concluded that standards that increase at a rate of 8 percent, 8 percent, and 10 percent in stringency for MYs 2024, 2025, and 2026, respectively (Alternative 2.5 of this analysis) are maximum feasible. NHTSA has determined that the need of the United States to conserve energy compels more stringent standards if they appear consistent with the other factors that NHTSA must consider, particularly in light of introduction by industry of many new vehicles with significant fuel economy improvements independent of this or any other agency action. NHTSA has determined that Alternative 2.5 is technologically feasible, economically practicable (based on manageable average per-vehicle cost increases, significant consumer benefits, minimal effects on sales, and estimated increases in employment, among other things), and complementary to other motor vehicle standards of the Government that are simultaneously applicable, as described below. Despite only two years having passed since the 2020 final rule, enough has changed in the U.S. and the world that revisiting the CAFE standards for MYs 2024–2026, and

raising their stringency considerably, is both appropriate and reasonable.

The following sections discuss in more detail the statutory requirements and considerations involved in NHTSA's determination of maximum feasible CAFE standards, and NHTSA's explanation of its balancing of factors for this determination.

A. EPCA, as Amended by EISA

EPCA, as amended by EISA, contains a number of provisions regarding how NHTSA must set CAFE standards. DOT (by delegation, NHTSA)⁷⁹¹ must establish separate CAFE standards for passenger cars and light trucks⁷⁹² for each model year,⁷⁹³ and each standard must be the maximum feasible that the Secretary (again, by delegation, NHTSA) believes the manufacturers can achieve in that model year.⁷⁹⁴ In determining the maximum feasible levels of CAFE standards, EPCA requires that NHTSA consider four statutory factors: Technological feasibility, economic practicability, the effect of other motor vehicle standards of the Government on fuel economy, and the need of the United States to conserve energy.⁷⁹⁵ In addition, NHTSA has the authority to consider (and typically does consider) other relevant factors, such as the effect of CAFE standards on motor vehicle safety and consumer preferences. The ultimate determination of what standards can be considered maximum feasible involves a weighing and balancing of factors, and the balance may shift depending on the information before NHTSA about the expected circumstances in the model years covered by the rulemaking. The agency's decision must also be guided by the overarching purpose of EPCA, energy conservation, while balancing these factors.⁷⁹⁶

Besides the requirement that the standards be maximum feasible for the fleet in question and the model year in question, EPCA/EISA also contain several other requirements, as follow.

1. Lead Time

EPCA requires that NHTSA prescribe new CAFE standards at least 18 months

before the beginning of each model year.⁷⁹⁷ For amendments to existing standards (as this rule establishes), EPCA requires that if the amendments make an average fuel economy standard more stringent, at least 18 months of lead time must be provided.⁷⁹⁸ Thus, if the first year for which NHTSA is amending standards in this rule is MY 2024, NHTSA interprets this provision as requiring the agency to issue a final rule covering MY 2024 standards no later than April 2022. Commenters who raised the issue of lead time nearly universally did so in the context of economic practicability; those comments have been summarized and addressed in that section below.

2. Separate Standards for Cars and Trucks, and Minimum Standards for Domestic Passenger Cars

As mentioned above, EPCA requires NHTSA to set separate standards for passenger cars and light trucks for each model year.⁷⁹⁹ Based on the plain language of the statute, NHTSA has long interpreted this requirement as preventing the agency from setting a single combined CAFE standard for cars and trucks together. Congress originally required separate CAFE standards for cars and trucks to reflect the different fuel economy capabilities of those different types of vehicles, and over the history of the CAFE program, has never revised this requirement. Even as many cars and trucks have come to resemble each other more closely over time—many crossover and sport-utility models, for example, come in versions today that may be subject to either the car standards or the truck standards depending on their characteristics—it is still accurate to say that vehicles with truck-like characteristics such as 4-wheel drive, cargo-carrying capability, etc., currently consume more fuel per mile than vehicles without these characteristics.

EPCA, as amended by EISA, also requires another separate standard to be set for domestically manufactured⁸⁰⁰ passenger cars. Unlike the generally applicable standards for passenger cars and light trucks described above, the

⁷⁹¹ EPCA and EISA direct the Secretary of Transportation to develop, implement, and enforce fuel economy standards (see 49 U.S.C. 32901 *et seq.*), which authority the Secretary has delegated to NHTSA at 49 CFR 1.95(a).

⁷⁹² 49 U.S.C. 32902(b)(1) (2007).

⁷⁹³ 49 U.S.C. 32902(a) (2007).

⁷⁹⁴ *Id.*

⁷⁹⁵ 49 U.S.C. 32902(f) (2007).

⁷⁹⁶ *Center for Biological Diversity v. NHTSA*, 538 F.3d 1172, 1197 (9th Cir. 2008) (“Whatever method it uses, NHTSA cannot set fuel economy standards that are contrary to Congress's purpose in enacting the EPCA—energy conservation.”).

⁷⁹⁷ 49 U.S.C. 32902(a) (2007).

⁷⁹⁸ 49 U.S.C. 32902(g)(2) (2007).

⁷⁹⁹ 49 U.S.C. 32902(b)(1) (2007).

⁸⁰⁰ In the CAFE program, “domestically manufactured” is defined by Congress in 49 U.S.C. 32904(b). The definition roughly provides that a passenger car is “domestically manufactured” as long as at least 75 percent of the cost to the manufacturer is attributable to value added in the United States, Canada, or Mexico, unless the assembly of the vehicle is completed in Canada or Mexico *and* the vehicle is imported into the United States more than 30 days after the end of the model year.

⁷⁹⁰ 538 F.3d 1172 (9th Cir. 2008).

compliance obligation of the minimum domestic passenger car standard (MDPCS for brevity) is identical for all manufacturers. The statute clearly states that any manufacturer's domestically manufactured passenger car fleet must meet the greater of either 27.5 mpg on average, or "92 percent of the average fuel economy projected by the Secretary for the combined domestic and non-domestic passenger automobile fleets manufactured for sale in the United States by all manufacturers in the model year, which projection shall be published in the **Federal Register** when the standard for that model year is promulgated in accordance with [49 U.S.C. 32902(b)]."⁸⁰¹

The organization Securing America's Future Energy commented that the structure of the CAFE program is overly complex, with separate standards for passenger cars and light trucks, and the MDPCS. Securing America's Future Energy stated that while credit mechanisms implemented with the passage of EISA "allow automakers to achieve the same level of fuel consumption at a lower cost," the "mechanisms . . . remain cumbersome."⁸⁰² NHTSA agrees that the CAFE program has these attributes, but notes that the aspects of the program identified by the commenter are statutory, and thus beyond the agency's power to address.

With regard to the MDPCS in particular, since that requirement was promulgated, the "92 percent" has always been greater than 27.5 mpg, and foreseeably will continue to be so in the future. While NHTSA published MDPCSs for MYs 2024–2026 at 49 CFR 531.5(d) as part of the 2020 final rule, the statutory language is clear that the MDPCS must be determined at the time that an overall passenger car standard is promulgated and published in the

Federal Register. Thus, any time NHTSA establishes or changes a passenger car standard for a model year, the MDPCS must also be evaluated or re-evaluated and established accordingly.

As in the 2020 final rule, NHTSA recognizes industry concerns that actual total passenger car fleet standards have differed significantly from past projections, perhaps more so when the agency has projected significantly into the future. In that final rule, because the compliance data showed that the standards projected in 2012 were consistently more stringent than the actual standards, by an average of 1.9 percent. NHTSA stated that this difference indicated that in rulemakings conducted in 2009 through 2012, NHTSA's and EPA's projections of passenger car vehicle footprints and production volumes, in retrospect, underestimated the production of larger passenger cars over the MYs 2011 to 2018 period.⁸⁰³

Unlike the passenger car standards and light truck standards which are vehicle-attribute-based and automatically adjust with changes in consumer demand, the MDPCS are not attribute-based, and therefore do not adjust with changes in consumer demand and production. They are instead fixed standards that are established at the time of the rulemaking. As a result, by assuming a smaller-footprint fleet, on average, than what ended up being produced, the MY 2011–2018 MDPCS ended up being more stringent and placing a greater burden on manufacturers of domestic passenger cars than was projected and expected at the time of the rulemakings that established those standards. In the 2020 final rule, therefore, NHTSA agreed with industry concerns over the impact of changes in consumer demand (as compared to what was assumed in 2012 about future consumer demand for

greater fuel economy) on manufacturers' ability to comply with the MDPCS and in particular, manufacturers that produce larger passenger cars domestically. Some of the largest civil penalties for noncompliance in the history of the CAFE program have been paid for noncompliance with the MDPCS. NHTSA also expressed concern at that time that consumer demand may shift even more in the direction of larger passenger cars if fuel prices continue to remain low. Sustained low oil prices can be expected to have real effects on consumer demand for additional fuel economy, and if that occurs, consumers may foreseeably be even more interested in 2WD crossovers and passenger-car-fleet SUVs (and less interested in smaller passenger cars) than they are at present.

Therefore, in the 2020 final rule, to help avoid similar outcomes in the 2021–2026 timeframe to what had happened with the MDPCS over the preceding model years, NHTSA determined that it was reasonable and appropriate to consider the recent projection errors as part of estimating the total passenger car fleet fuel economy for MYs 2021–2026. NHTSA therefore projected the total passenger car fleet fuel economy using the central analysis value in each model year, and applied an offset based on the historical 1.9 percent difference identified for MYs 2011–2018.

In the proposal, NHTSA proposed to retain the 1.9 percent offset for the MDPCS for MYs 2024–2026, on the basis that the proposal would increase stringency considerably over the baseline standards and that civil penalties have also recently increased, so that the MDPCS may continue to pose a significant challenge to certain manufacturers. Table VI–1 shows the calculation values used to determine the total passenger car fleet fuel economy value for each model year for the proposal.

⁸⁰¹ 49 U.S.C. 32902(b)(4) (2007).

⁸⁰² Securing America's Future Energy, Docket No. NHTSA–2021–0053–1513, at 18.

⁸⁰³ See 85 FR 25127 (Apr. 30, 2020).

Table VI-1 – Calculation of the Projected Total Passenger Car Fleet Standard and the Minimum Domestic Passenger Car Standard (92 Percent of the Total Passenger Car Standard) for the Proposal

	2024	2025	2026
Projected Total PC Fleet Standard – Central Analysis (mpg)	49.2	53.4	58.1
Offset: Average Historical Difference Between Regulatory Analyses and Actual Total PC Fleet Standard (percent)	-1.9	-1.9	-1.9
Offset: Average Historical Difference Between Regulatory Analyses and Actual Total PC Fleet Standard (mpg)	-0.92	-1.00	-1.08
Projected Total PC Standard Accounting for Historical Offset (mpg)	48.2	52.4	57.0
Minimum Domestic Passenger Car Standard = 92% of Projected Total PC Standard Accounting for Historical Offset (mpg)	44.4	48.2	52.4

Using this approach, the MDPCS under each regulatory alternative

considered in the proposal was thus as shown in Table VI-2.

Table VI-2 – Proposed MDPCS for Each Regulatory Alternative, Calculated per 1.9 Percent Offset

Alternative	MY 2024	MY 2025	MY 2026
No Action	41.4	42.1	42.7
Alternative 1	44.9	46.5	48.0
Alternative 2 (Proposed)	44.4	48.2	52.4
Alternative 3	45.4	50.4	56.0

NHTSA sought comment on another approach to offsetting the MDPCS, which attempted to project explicitly how passenger car footprints might change in the future. NHTSA stated that examination of the average footprints of passenger cars sold in the U.S. from 2008, when EPA began reporting

footprint data, to 2020 indicated a clear and statistically significant trend of gradually increasing average footprint (Figure VI-1). The average annual increase in passenger car footprint, estimated by ordinary least squares, indicated that the passenger car footprints increased by an average of

0.1206 square feet annually over the 2008–2020 period. The estimated average increase was statistically significant at the 0.000001 level, with a 95 percent confidence interval of (0.0929, 0.1483).

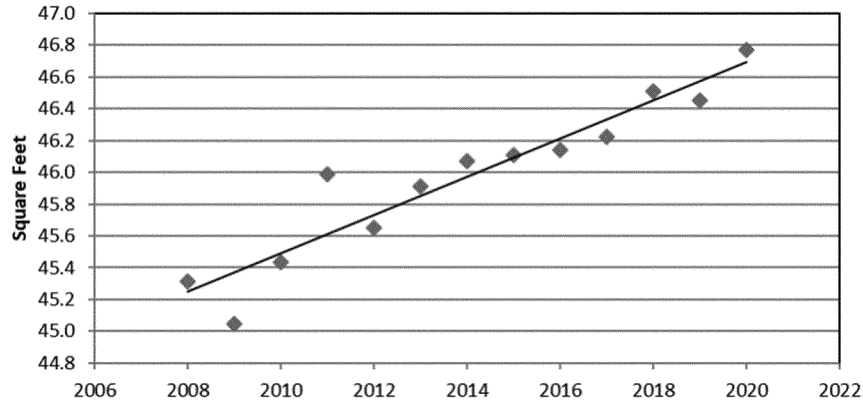

Figure VI-1 – Trend in Passenger Car Footprint, 2008-2020 (Source: EPA 2020 Automotive Trends Report)

The alternate method for calculating an offset to the MDPCS was described as consisting of three steps, as follows:

- Starting from the average footprint of passenger cars in 2020 as reported by EPA, add 0.1206 square feet per year through 2026.

- Calculate the estimated fuel economy of passenger cars using the average projected footprint numbers calculated in step 1 and the footprint functions that are the passenger car standards for the corresponding model year, which then become “the

Secretary’s projected passenger car fuel economy numbers.”

- Apply the 92 percent factor to calculate the MDPCS for 2024, 2025, and 2026.

The results of this approach are shown in Table VI-3.

Table VI-3 – Alternate Approach to Offsetting MDPCS, on Which NHTSA Sought Comment

Alternative	MY 2024	MY 2025	MY 2026
No Action	41.6	42.2	42.7
Alternative 1	45.1	46.5	48.0
Alternative 2 (Proposed)	44.6	48.3	52.4
Alternative 3	45.5	50.5	56.0

Comparing all of these, Table VI-4 shows (1) the unadjusted 92 percent MDPCS for MYs 2024–2026, (2) the

proposed 1.9 percent-offset MDPCS for MYs 2024–2026, and (3) the alternate

approach offset MDPCS for MYs 2024–2026.

Table VI-4 – NPRM Comparison of the Required mpg Levels for the MDPCS by Regulatory Alternative and Offset Approach

NPRM Alternative	MY 2024	MY 2025	MY 2026
No Action			
Unadjusted 92%	42.2	42.9	43.5
1.9% offset	41.4	42.1	42.7
Alternate approach offset	41.6	42.2	42.7
Alternative 1			
Unadjusted 92%	45.8	47.3	48.9
1.9% offset	44.9	46.5	48.0
Alternate approach offset	45.1	46.5	48.0
Alternative 2 (Proposed)			
Unadjusted 92%	45.2	49.2	53.4
1.9% offset	44.4	48.2	52.4
Alternate approach offset	44.6	48.3	52.4
Alternative 3			
Unadjusted 92%	50.2	55.8	62.0
1.9% offset	45.4	50.4	56.0
Alternate approach offset	45.5	50.5	56.0

BILLING CODE 4910-59-C

While the CAFE Model analysis underlying the proposal, the PRIA, and the Draft SEIS did not reflect an offset to the unadjusted 92 percent MDPCS, separate analysis that did reflect the change demonstrated that doing so did not change estimated impacts of any of the regulatory alternatives under consideration, despite the mpg values being slightly different as shown in Table VI-4.

NHTSA sought comment on the discussion above, and also on whether to apply the MDPCS without any modifier.

Comments on the MDPCS were mixed. Industry commenters generally supported the proposal to continue to adjust the MDPCS downward.⁸⁰⁴ Other commenters disagreed with the proposal to continue to adjust the MDPCS. The UAW expressed concern that automakers' strategies for complying with the MDPCS might involve "gaming the system," and stated that ". . . regulations and laws should be structured to incentivize the production of a diverse domestic fleet and not weaken the intended purpose of the

[MDPCS]."⁸⁰⁵ A coalition of environmental group commenters stated that the adjustment was unlawful,⁸⁰⁶ and UCS provided additional separate comments arguing that "NHTSA must base the MDPCS on NHTSA's passenger car footprint projections in the central analysis of the rule, as is legally required."⁸⁰⁷ UCS commented that "[i]t is patently arbitrary to conduct the analysis for CAFE standards using a certain set of projections, and then, when setting other standards in the same rulemaking, state that the projections in the main analysis are wrong. The agency either has confidence in the projections in the central analysis or they do not; and if they do not, they should change them."⁸⁰⁸ Regarding the alternative approach to offsetting the MDPCS on which NHTSA sought comment, UCS stated that it was fundamentally similar to the proposed approach to offsetting, and "[t]he agency shows no substantial benefit to this alternative approach, and instead finds quite clearly just how

drastically either offset differs from the values found in its central analysis underpinning the rule."⁸⁰⁹ UCS further argued that it was unreasonable to assume that the adjustment could only go in one direction, because it was entirely possible that passenger car footprints could shift smaller depending on future fuel prices.⁸¹⁰

For the final rule, NHTSA is continuing to employ the 1.9 percent offset for the MDPCS. NHTSA disagrees that EISA requires the agency to base the MDPCS specifically on the passenger car footprint projections for the central analysis, because 49 U.S.C. 32902 simply states "92 percent of the average fuel economy projected by the Secretary" (emphasis added) for the combined passenger car fleet for the model year(s) in question. NHTSA agrees with both industry commenters and UCS that it is difficult to predict passenger car footprint trends in advance, which means that, as various commenters have consistently noted, the MDPCS may turn out quite different from 92 percent of the ultimate average passenger car standard once a model year is complete. Nevertheless, NHTSA is setting the MDPCS as part of this rulemaking, consistent with the statute,

⁸⁰⁴ See, e.g., Auto Innovators, Docket No. NHTSA-2021-0053-1492, at 15, 55-56; Ford, Docket No. NHTSA-2021-0053-1545, at 2.

⁸⁰⁵ UAW, Docket No. NHTSA-2021-0053-0931, at 4.

⁸⁰⁶ CBD et al., Docket No. NHTSA-2021-0053-1572, at 9.

⁸⁰⁷ UCS, Docket No. NHTSA-2021-0053-1567, at 23-24.

⁸⁰⁸ *Id.* at 21.

⁸⁰⁹ *Id.*

⁸¹⁰ *Id.* at 24.

recognizing that it will not adjust in response to those footprint trends unless and until NHTSA conducts a new rulemaking. NHTSA is also concerned, as the UAW commenters suggested, that automakers struggling to meet the unadjusted MDPCS may choose to import their passenger cars rather than producing them domestically. Given the stringency of the overall standards and the increase in the civil penalty rate, NHTSA continues to believe that this adjustment is appropriate, reasonable, and consistent with Congress' intent.

3. Attribute-Based and Defined by a Mathematical Function

EISA requires NHTSA to set CAFE standards that are "based on 1 or more attributes related to fuel economy and express[ed] . . . in the form of a mathematical function."⁸¹¹ Historically, NHTSA has based standards on vehicle footprint, and proposed to continue to do so for MYs 2024–2026. As in previous rulemakings, NHTSA proposed to define the standards in the form of a constrained linear function that generally sets higher (more stringent) targets for smaller-footprint vehicles and lower (less stringent) targets for larger-footprint vehicles. NHTSA sought comment both on the continued use of footprint as the relevant attribute and on the continued use of the constrained linear curve shapes. Comments received on those topics are addressed and responded to in Section III.B of the preamble.

A coalition of environmental group commenters urged NHTSA to set a "backstop," or "minimum standard below which the actual performance of the fleet may not fall."⁸¹² The commenters stated that, "[f]or example, in MY 2019, the most recent year for which information is available, the fleet mix of sedans and station wagons had shifted to only 33 percent of the fleet, compared to 80 percent in MY 1975. As a result of mix shift changes like this, real-world fuel economy has been lower than NHTSA has previously projected."⁸¹³ The commenters argued that "NHTSA should explain why it failed to propose a backstop in this rulemaking and should commit to doing so in its next rulemaking."⁸¹⁴

In response, finalizing a backstop as part of this rulemaking is not within scope, because (as commenters note) NHTSA did not propose a backstop nor discuss one in the NPRM. However, as NHTSA explained in the 2012 final rule

in response to similar comments, the MDPCS "was intended to act as a 'backstop,' ensuring that domestically-manufactured passenger cars reached a given mpg level even if the market shifted in ways likely to reduce overall fleet mpg. Congress was silent as to whether the agency could or should develop similar backstop standards for imported passenger cars and light trucks. NHTSA has struggled with this question since EISA was enacted."⁸¹⁵ Even in the 2010 final rule (75 FR 25324, May 7, 2010), NHTSA considered this question and declined to enact additional minimum standards for imported passenger cars and light trucks, out of concern about the possibility of such standards imposing inequitable regulatory burdens of the kind that attribute-based standards sought to avoid. NHTSA stated that:

Unless the backstop was at a very weak level, above the high end of this range, then some percentage of manufacturers would be above the backstop even if the performance of the entire industry remains fully consistent with the emissions and fuel economy levels projected for the final standards. For these manufacturers and any other manufacturers who were above the backstop, the objectives of an attribute-based standard would be compromised and unnecessary costs would be imposed. This could directionally impose increased costs for some manufacturers. It would be difficult if not impossible to establish the level of a backstop standard such that costs are likely to be imposed on manufacturers only when there is a failure to achieve the projected reductions across the industry as a whole. An example of this kind of industry-wide situation could be when there is a significant shift to larger vehicles across the industry as a whole, or if there is a general market shift from cars to trucks. The problem the agency is concerned about in those circumstances is not with respect to any single manufacturer, but rather is based on concerns over shifts across the fleet as a whole, as compared to shifts in one manufacturer's fleet that may be more than offset by shifts the other way in another manufacturer's fleet. However, in this respect, a traditional backstop acts as a manufacturer-specific standard.⁸¹⁶

In the 2012 final rule, NHTSA stated that:

We continue to agree with the environmental and consumer group commenters that we have authority to adopt additional backstop standards if we deem it appropriate to do so. However, we also continue to conclude that insufficient time has passed in which manufacturers have been subject to the attribute-based standards to assess whether or not backstops would in fact help ensure that fuel savings anticipated by the agency at the time of the final rule are met, and even if they did, whether the benefits of that

insurance outweigh potential impacts [on] consumer choice that could occur by heading down the road that Congress rejected when it required CAFE standards to be attribute-based. If we determined that backstops for imported passenger cars and light trucks were necessary, it would be because consumers are choosing different (likely larger) vehicles in the future than the agencies assumed in this rulemaking analysis. Imposing additional backstop standards for those fleets would require manufacturers to build vehicles which the majority of consumers (under this scenario) would presumably not want. Vehicles that cannot be sold are the essence of economic impracticability, and vehicles that do not sell cannot save fuel or reduce emissions, because they are not on the roads, and thus do not meet the need of the nation to conserve fuel.

On the other hand, based on the assumptions underlying the analysis for this rulemaking, consumers will experience significant benefits as a result of buying the vehicles manufactured to meet these standards. We have no reason to expect that consumers will turn a blind eye to these benefits, and recent trends indicate that fuel economy is rising in importance as a factor in vehicle purchasing decisions. We thus conclude, for purposes of this final rule, that imposing additional backstop standards for imported passenger cars and light trucks would be premature. As stated in the NPRM, NHTSA will continue to monitor vehicle sales trends and manufacturers' response to the standards, and we will revisit this issue as part of the future rulemaking to develop final standards for MYs 2022–2025.⁸¹⁷

It appears that this question has ripened. Looking at the EPA Automotive Trends Report for 2021, there has been growth in vehicle size and mix shifts from cars to trucks and SUVs over time:

Between MY 2008 and 2020, fuel economy and footprint increased within each of the five vehicle types, and horsepower increased in four. Weight decreased within each of the vehicle types. These trends within vehicle types are largely attributable to design and technology changes over that time span. In addition to technology changes, the market shifted towards car and truck SUVs, which are often larger, heavier, more powerful, and less fuel efficient than sedan/wagons they replaced. These market changes increased the overall horsepower and footprint of the average new vehicle, compared to technology-driven changes alone. The trend towards larger, heavier, and more powerful vehicles has also offset some of the fleetwide fuel economy and CO₂ emission benefits that otherwise would have been achieved through improving technology. Market trends led to an increase in the weight of a new average vehicle, even as weight fell within each vehicle type.⁸¹⁸

⁸¹⁷ 77 FR 63022 (Oct. 15, 2012).

⁸¹⁸ EPA Automotive Trends Report, 2021, Highlights. Available at <https://www.epa.gov/automotive-trends/highlights-automotive-trends-report>. (Accessed: March 15, 2022)

⁸¹¹ 49 U.S.C. 32902(b)(3)(A) (2007).

⁸¹² CBD, et al., at 9–10.

⁸¹³ *Id.*

⁸¹⁴ *Id.*

⁸¹⁵ 77 FR 63020 (Oct. 15, 2012).

⁸¹⁶ 75 FR 25324, 25369 (May 7, 2010).

EPA goes on to note, however, that most manufacturers have improved fuel economy and reduced CO₂ emissions over the MY 2015–2020 time frame, explaining that most increases in emissions/reductions in fuel economy at a manufacturer level occur because (as commenters suggested) the manufacturers are producing more SUV/trucks and fewer sedan/wagons.⁸¹⁹ Fleetwide, emissions and fuel economy are still the best they have ever been, and continue to improve.

At the industry-wide and individual-manufacturer level, then, to the extent that “backsliding” is occurring, it appears to be the result of trucks and SUVs increasing their share of the market, and sedans and station wagons decreasing theirs. It is not clear to NHTSA at this time that setting minimum standards for imported passenger cars and light trucks comparable to the MDPCS would meaningfully change this market trend. Looking forward, as discussed further below, manufacturers themselves may be improving this situation by offering more and more higher-fuel-economy vehicles in a variety of segments. If American consumers continue to seek out pickups, automakers are increasingly responding with advanced technology, higher-fuel-economy offerings, even in that segment. Moreover, recognizing that not all consumers will want these specific technology vehicles, NHTSA still believes that setting stringent attribute-based standards, as NHTSA is doing in this rulemaking, will require manufacturers to keep improving *all* their vehicles. NHTSA thus concludes that additional minimum standards for imported passenger cars and light trucks, besides being out of scope for this final rule, are not warranted at this time. If evidence surfaces that manufacturers are, in fact, letting ICE vehicle fuel economy languish while complying solely (or heavily) with BEV technology, NHTSA would consider this an equity issue and would reevaluate our position on additional minimum standards.

4. Number of Model Years for Which Standards May Be Set at a Time

EISA also states that NHTSA shall “issue regulations under this title prescribing average fuel economy standards for at least 1, but not more than 5, model years.”⁸²⁰ In this rule, NHTSA is setting CAFE standards for three model years, MYs 2024–2026. This action fits squarely within the

plain language of the statute. No comments were received on this statutory requirement.

5. Maximum Feasible Standards

As discussed above, EPCA requires NHTSA to consider four factors in determining what levels of CAFE standards would be maximum feasible. NHTSA presents in the sections below its understanding of the meanings of those four factors.

(a) Technological Feasibility

“Technological feasibility” refers to whether a particular method of improving fuel economy is available for deployment in commercial application in the model year for which a standard is being established. Thus, NHTSA is not limited in determining the level of new standards to technology that is already being applied commercially at the time of the rulemaking. For both the proposal and for this final rule, NHTSA has considered a wide range of technologies that improve fuel economy, while considering the need to account for which technologies have already been applied to which vehicle model/configuration, as well as the need to estimate realistically the cost and fuel economy impacts of each technology as applied to different vehicle models/configurations. NHTSA has not, however, attempted to account for every technology that might conceivably be applied to improve fuel economy, nor does NHTSA believe it is necessary to do so given that many technologies address fuel economy in similar ways.⁸²¹

NHTSA notes that the technological feasibility factor allows NHTSA to set standards that force the development and application of new fuel-efficient technologies, but this factor does not *require* NHTSA to do so.⁸²² In the 2012 final rule, NHTSA stated that “[i]t is important to remember that technological feasibility must also be balanced with the other of the four statutory factors. Thus, while ‘technological feasibility’ can drive standards higher by assuming the use of technologies that are not yet commercial, ‘maximum feasible’ is also defined in terms of economic practicability, for example, which might caution the agency against basing

standards (even fairly distant standards) *entirely* on such technologies.”⁸²³

NHTSA further stated that “as the ‘maximum feasible’ balancing may vary depending on the circumstances at hand for the model year in which the standards are set, the extent to which technological feasibility is simply met or plays a more dynamic role may also shift.”⁸²⁴ In the proposal, NHTSA stated that for purposes of MYs 2024–2026, NHTSA was certain that sufficient technology exists to meet the standards—even for the most stringent regulatory alternative. NHTSA further explained that for the proposal, the question was more likely rather, given that the technology exists, how much of it should be required to be added to new cars and trucks in order to conserve more energy, and how to balance that objective against the additional cost of adding that technology.

Most commenters addressing the question of technological feasibility supported the agency’s interpretation of the factor and agreed that all of the regulatory alternatives considered in the proposal were likely technologically feasible. Supplier organizations such as Manufacturers of Emission Controls Association (MECA) and Motor & Equipment Manufacturers Association (MEMA) agreed that the proposal would encourage broad deployment of a variety of available technologies for compliance, while encouraging innovation, with MEMA stating that the proposed targets were achievable with currently available technology resulting from long-term supplier commitments and investments.⁸²⁵ CARB stated that Alternative 3 was technologically feasible.⁸²⁶ EDF stated that “more protective standards” (*i.e.*, than those set in the 2020 final rule) were technologically feasible because NHTSA had previously found that more stringent alternatives were technologically feasible, both in the 2012 final rule and in the 2016 Draft TAR, because the California Framework Agreements had occurred, and “[t]he technological feasibility of stronger standards is also supported by the fact that many manufacturers, after the SAFE2 rule, did not change ‘significantly’ from product plans

⁸²¹ For example, NHTSA has not considered high-speed flywheels as potential energy storage devices for hybrid vehicles; while such flywheels have been demonstrated in the laboratory and even tested in concept vehicles, commercially available hybrid vehicles currently known to NHTSA use chemical batteries as energy storage devices, and the agency has considered a range of hybrid vehicle technologies that do so.

⁸²² See 77 FR 63015 (Oct. 12, 2012).

⁸²³ *Id.*

⁸²⁴ *Id.*

⁸²⁵ MECA, Docket No. NHTSA–2021–0053–1113, at 2; MEMA, Docket No. NHTSA–2021–0053–1528, at 3, 5.

⁸²⁶ CARB, Docket No. NHTSA–2021–0053–1521, at 2.

⁸¹⁹ *Id.*

⁸²⁰ 49 U.S.C. 32902(b)(3)(B) (2007).

established in response to the 2012 standards.”⁸²⁷

AFPM, in contrast, argued that the proposed standards were beyond technologically feasible because OEMs are currently relying on credits to meet the existing standards. AFPM argued that “[r]ather than presenting existing data in its Proposal, NHTSA apparently relies on aspirational press releases from automakers Aspiration does not equate to technological feasibility, not have previous aspirational statements proved accurate. . . . NHTSA is relying on a major increase in EVs in order for OEMs to comply, when it should be setting standards that can feasibly be met with gasoline and diesel vehicles only.”⁸²⁸ AFPM argued that because the proposed standards were beyond technologically feasible, they were therefore contrary to law.⁸²⁹

With regard to NHTSA’s interpretation of the technological feasibility factor, California Attorney General et al. agreed with NHTSA’s definition and analysis, stating that “[t]he technology needed to meet the Proposed Standards already exists, and those standards are therefore achievable.” South Coast AQMD commented that every regulatory alternative was technologically feasible, and argued that by reframing the technological feasibility factor in the context of the other factors, NHTSA sought to “double count” “the constraints imposed by the economic practicability factor and ignore the implications of how technology today supports even the most stringent alternative standard in the most distant year.”⁸³⁰ South Coast AQMD concluded that “[t]his factor should thus weigh in favor of more stringent standards, given the Congressional purpose to conserve energy even through forcing technology beyond what the market would derive independently.”⁸³¹ EDF cited *Center for Auto Safety* in its comments and stated that Congress intended for the technological feasibility factor to be technology forcing when NHTSA was determining maximum feasible standards, and that NHTSA was not limited by the technology available at the time of the rulemaking.⁸³² Tesla similarly commented that because courts have described EPCA as technology forcing, “[t]hus, NHTSA’s

evaluation of technological feasibility should naturally include an evaluation of technology beyond those currently in commercial use, including advanced or cutting-edge vehicle technologies.”⁸³³

In response, NHTSA continues to believe, consistent with most comments, that all of the regulatory alternatives considered in the proposal and in this final rule are technologically feasible, because the technology to meet them exists already. NHTSA agrees that the technological feasibility factor *can* be technology-forcing, as NHTSA has been saying since the 2012 final rule. To the extent that one interprets “technology-forcing” as “requiring the introduction of *more existing technology than consumers might otherwise request in the absence of new standards*,” then NHTSA agrees that the final standards are technology-forcing in that respect, but they do not compel the introduction of yet-unproven technologies.

Thus, technological feasibility is one factor considered in the context of the others—as such, NHTSA does not agree with South Coast AQMD that NHTSA is “double-counting” economic practicability. NHTSA is simply balancing the factors together by concluding that “if enough technology exists to meet standards represented by each regulatory alternative, then technological feasibility is not at issue; the next question is one of economic practicability, and how much technology can be applied before costs become too high for the market to bear?”

With regard to the comments from AFPM, NHTSA first wishes to clarify that the agency’s decision of maximum feasible standards does not rely on future manufacturer electrification, as the analysis supporting this rule shows a path toward achieving compliance with the final standards without increasing reliance on electrification. The agency is simply noting that if companies want to choose a different technology path from the one we present in our modeling, which they seem to be indicating they are likely to do, then compliance with the final standards may be even more cost-effective.

The agency also disagrees that product announcements are poor evidence of future manufacturer intent, particularly from established manufacturers, and particularly given evidence that in addition to the announcements, manufacturers have already introduced a number of new highly fuel efficient models in addition to planned and announced rollouts.

And consumers are responding with increasing purchases of these vehicles. If the announcements could not be trusted, then the vehicles would not be appearing for reservation and sale—and yet the vehicles *are* beginning to appear for reservation and sale. Additionally, these vehicles are, for the most part, based on existing fuel-economy-improving technologies, even if they represent improvements on those technologies. Moreover, the stock market would stop rewarding OEMs who backtrack repeatedly on announcements, which would foreseeably discourage such backtracking. In short, announcements, combined with emerging evidence from consumers and the stock market confirming that most announcements, particularly from major automakers, reflect reality, makes NHTSA comfortable that reliance—in part—on the announcements is justified.

(b) Economic Practicability

“Economic practicability” has consistently referred to whether a standard is one “within the financial capability of the industry, but not so stringent as to” lead to “adverse economic consequences, such as a significant loss of jobs or unreasonable elimination of consumer choice.”⁸³⁴ In evaluating economic practicability, NHTSA considers the uncertainty surrounding future market conditions and consumer demand for fuel economy alongside consumer demand for other vehicle attributes. There is not necessarily a bright-line test for whether a regulatory alternative is economically practicable, but there are several metrics that we discuss below that we find can be useful for making this assessment. In determining whether standards may or may not be economically practicable, NHTSA considers:

Application rate of technologies—whether it appears that a regulatory alternative would impose undue burden on manufacturers in either or both the near and long term in terms of how much and which technologies might be required. This metric connects to the next two metrics, as well.

Other technology-related considerations—related to the application rate of technologies, whether it appears that the burden on several or more manufacturers might cause them to respond to the standards in ways that compromise, for example, vehicle safety, or other aspects of performance that may be important to consumer acceptance of new products.

⁸²⁷ EDF, Docket No. NHTSA–2021–0053–1617, at 3–4.

⁸²⁸ AFPM, Docket No. NHTSA–2021–0053–1530, at 4–5.

⁸²⁹ *Id.*, at 5.

⁸³⁰ South Coast AQMD, Docket No. NHTSA–2021–0053–1477, at 4.

⁸³¹ *Id.*, at 3–4.

⁸³² EDF, at 3.

⁸³³ Tesla, Docket No. NHTSA–2021–0053–1480–A1, at 4.

⁸³⁴ 67 FR 77015, 77021 (Dec. 16, 2002).

Cost of meeting the standards—even if the technology exists and it appears that manufacturers can apply it consistent with their product cadence, if meeting the standards will raise per-vehicle cost more than we believe consumers are likely to accept, which could negatively impact sales and employment in this sector, the standards may not be economically practicable. While consumer acceptance of additional new vehicle cost associated with more stringent CAFE standards is uncertain, NHTSA still finds this metric useful for evaluating economic practicability.

Sales and employment responses—as discussed above, sales and employment responses have historically been key to NHTSA's understanding of economic practicability.

*Uncertainty and consumer acceptance*⁸³⁵ of technologies—considerations not accounted for expressly in our modeling analysis, but important to an assessment of economic practicability given the timeframe of this rulemaking. Consumer acceptance can involve consideration of anticipated consumer responses not just to increased vehicle cost and consumer valuation of fuel economy, but also the way manufacturers may change vehicle models and vehicle sales mix in response to CAFE standards.

Over time, NHTSA has tried different methods to account for economic practicability. Many years ago, prior to the MY 2005–2007 rulemaking (68 FR 16868, April 7, 2003) under the non-attribute-based (fixed value) CAFE standards, NHTSA sought to ensure the economic practicability of standards in part by setting them at or near the capability of the “least capable manufacturer” with a significant share of the market, *i.e.*, typically the manufacturer whose fleet mix was, on average, the largest and heaviest, generally having the highest capacity and capability so as not to limit the availability of those types of vehicles to consumers. NHTSA rejected the “least capable manufacturer” approach several rulemakings ago and no longer believes that it is consistent with our root interpretation of economic practicability. Economic practicability focuses on the capability of the *industry* and seeks to avoid adverse consequences such as (*inter alia*) a significant loss of jobs or unreasonable elimination of consumer choice. If the overarching purpose of EPCA is energy

conservation, NHTSA believes that it is reasonable to expect that maximum feasible standards may be harder for some automakers than for others, and that they need not be keyed to the capabilities of the least capable manufacturer. Indeed, keying standards to the least capable manufacturer may disincentivize innovation by rewarding laggard performance.

NHTSA has also sought to account for economic practicability by applying marginal cost-benefit analysis since the first rulemakings establishing attribute-based standards, considering both overall societal impacts and overall consumer impacts. Whether the standards maximize net benefits has thus been a significant, but not dispositive, factor in the past for NHTSA's consideration of economic practicability. Executive Order 12866, as amended by Executive Order 13563, states that agencies should “select, in choosing among alternative regulatory approaches, those approaches that maximize net benefits . . .” In practice, however, agencies, including NHTSA, must acknowledge that the modeling of net benefits does not capture all considerations relevant to economic practicability. Therefore, as in past rulemakings, NHTSA is considering net societal impacts, net consumer impacts, and other related elements in the consideration of economic practicability. That said, it is well within the agency's discretion to deviate from the level at which modeled net benefits are maximized if the agency concludes that the level would not represent the maximum feasible level for future CAFE standards. Economic practicability is complex, and like the other factors must be considered in the context of the overall balancing and EPCA's overarching purpose of energy conservation.

For purposes of this final rule, a way to organize the different economic practicability considerations is as follows: CAFE standards (represented by the different regulatory alternatives) require automakers to add technology to their new vehicles:

- adding technology can potentially make those new vehicles more expensive (and if that technology has to be added faster than or outside of normal product cycles (*i.e.*, the lead time consideration), it can be even more expensive);

- U.S. consumers may potentially object to either higher per-vehicle costs or to technology with which they are less familiar, possibly affecting sales, but consumer benefits from fuel savings high enough to offset these costs and even provide net savings may suggest

that per-vehicle costs, at least, are manageable for consumers and automakers;

- changes in sales may affect employment in the auto sector, but auto sector employment may also be affected by increasing technology application on new vehicles.

This causal chain is simpler than what occurs in real life, and as we discuss the different considerations below, we highlight where we believe it is reasonable to expect that real life may diverge from what our analysis shows, although we will retain the limitations on the agency's decision-making required by EPCA/EISA.

Application Rate of Technologies, Per-Vehicle Costs, and Lead Time

On the topic of application rate of technologies, comments to the proposal were, in many cases, different from comments received on earlier rulemakings. Some commenters still focused on specific application rates of specific technologies shown in the analysis for the proposal, often suggesting that greater application of those technologies was possible in the rulemaking time frame.⁸³⁶ Industry commenters tended to comment about their extensive electrification plans for the future, and then to argue that NHTSA cannot consider electrification in setting maximum feasible CAFE standards (as will be discussed further in Section VI.A.5.e)), and then to suggest that they would prefer not to continue improving the fuel economy of their ICE vehicles because they intend to focus instead on electrifying certain vehicles in their fleets, and that effort will consume their available capital resources.⁸³⁷

⁸³⁶ Section III.D.1 contains examples of such comments and NHTSA's responses.

⁸³⁷ For example, Auto Innovators commented that NHTSA's proposed standards would require more technology, which “would effectively negate EPA's proposed policy actions to incentivize greater production of electric vehicles,” and therefore NHTSA should “. . . adopt [less stringent] final standards that *do not require additional technology adoption beyond the pending GHG standards and that preserve incentives intended to encourage the production of EVs*” (emphasis added). Auto Innovators, Docket No. NHTSA–2021–0053–1492, at 32; Stellantis commented that “Stellantis believes NHTSA has overestimated the potential for ICE improvements on a [manufacturer] pathway that is focused on significant EV growth. . . . So, even if manufacturers could achieve these proposed MY 2024–2026 CAFE standards with conventional ICE technology, it would make little economic sense to pursue a duplicate ICE investment path only to abandon it a few short years later to meet 2030 electrification goals.” Stellantis, Document No. NHTSA–2021–0053–1527, at 12; Kia commented that “[w]hile it is beneficial to drive further improvements to ICEs to meet higher CAFE targets, capital diversion away from electrification will

⁸³⁵ See, e.g., *Center for Auto Safety v. NHTSA* (CAS), 793 F.2d 1322 (D.C. Cir. 1986) (Administrator's consideration of market demand as component of economic practicability found to be reasonable).

In response, NHTSA again finds itself in a place of some cognitive dissonance: Automakers are saying that NHTSA cannot consider the technology on which they intend to focus their efforts in the coming years, but that NHTSA *must* consider that they plan to focus all their efforts on that technology and therefore intend to make no further progress on the rest of their fleets. All available capital, according to these commenters, is tied up by a technology that NHTSA cannot consider—in which case, perhaps NHTSA cannot consider that that technology is tying up that capital. These outcomes do not seem reasonable. A different legal interpretation must be found, one that allows us to continue to meet our statutory purpose while respecting the restrictions Congress placed on us, in the most reasonable way possible.

Section VI.A.5.e) will discuss this in more detail below, but NHTSA continues to believe that 49 U.S.C. 32902(h) can be reasonably read to require NHTSA to exclude dedicated alternative fuel vehicles like BEVs from application in the analysis during the rulemaking time frame, but while still being aware of their existence in the world as a compliance option. Moreover, while NHTSA absolutely agrees that capital constraints are a relevant consideration in determining economic practicability, NHTSA does not agree that CAFE standards for MYs 2024–2026 could be maximum feasible if they required no investments to improve the fuel economy of ICE vehicles. It does not require “consider [ation of] the fuel economy of dedicated automobiles” to acknowledge that, even if automakers did make 50 percent of their light-duty fleets BEV in a given model year, technologies would still exist that could increase the fuel economy of the remaining ICE vehicles. These vehicles will remain on the road for many years after their purchase. If the overarching purpose of EPCA is energy conservation, then it is neither a reasonable nor appropriate interpretation of our statutory obligations to set standards for this timeframe that require no further technology application on half or more of the new vehicle fleet. Electrification is certainly a way to reduce fuel use, but not at the expense of additional, feasible overall energy conservation, and NHTSA’s analysis for the final rule demonstrates that compliance is achievable.

delay cost parity objectives that are critical” to meeting future electrification targets. Kia, Docket No. NHTSA–2021–0053–1525, at 10.

That said, NHTSA recognizes that in the 2012 final rule, NHTSA determined that enough technology application had been required for compliance with the MY 2012–2016 standards, that a slightly slower rate of increase in standard stringency was appropriate for MYs 2017–2021—in effect, that available technology had been depleted somewhat, and industry needed time to catch up.⁸³⁸ We know now that MYs 2017–2020 did turn out to be challenging for industry compliance, but NHTSA does not believe that this was due to unavailability of technology, so much as consumer demand over those model years for vehicles with lower fuel economy than anticipated in the 2012 final rule. The technology remains available, even if the vehicles sold during those model years had less of it.

NHTSA also continues to believe that the less-stringent-than-originally-anticipated standards for MYs 2021–2023 will provide automakers with at least a short grace period during which they have the opportunity to shift their focus back to more rapidly increasing stringency. Indeed, we are seeing that shift in focus in the frequent announcements and rollouts of new high-fuel-economy models, as discussed further in the NPRM and below.

However, as NHTSA also said in the 2012 final rule, we realize that automakers will likely be putting quite a lot of technology into meeting the baseline during MYs 2024–2025 (and, implicitly, 2026), and this understanding makes us cautious about choosing the most stringent alternative.⁸³⁹ But at the same time, fuel economy-improving technology was less developed in 2012, and NHTSA suggested in that rule that there was a difference in terms of capital between adding technology to a few vehicles and spreading it throughout a fleet.⁸⁴⁰ NHTSA continues to believe that that difference is important. The auto industry has submitted comments expressing their preference to concentrate their investments solely on electrification (which they say NHTSA cannot consider), but our analysis does not suggest that the additional investment that could be required by the final CAFE standards would be, on average, economically impracticable. NHTSA believes that improving the fuel efficiency of ICE vehicles will not only result in additional energy conservation while automakers work toward a fully electric future (as many have committed

⁸³⁸ 77 FR 63043 (Oct 15, 2012).

⁸³⁹ *Id.* at 63046.

⁸⁴⁰ *Id.*

to doing), but also is compelled by our statutory mandate. And if manufacturers determine that electric vehicles are the most cost-effective path toward achieving compliance, the CAFE program also accommodates that approach, as the statute and regulations provide clear rules on how electric and other alternative fuel vehicles are accounted for in determining compliance even while we don’t consider them in establishing the standards.

On the topic of per-vehicle costs, Consumer Reports commented that based on their regular purchases of new vehicles for testing, Consumer Reports estimated that vehicle prices adjusted for inflation have not increased significantly over the last decade.⁸⁴¹ Consumer Reports stated that given that CAFE standards have been increasing concurrently, CAFE standards must not be adding significant cost to new vehicles.⁸⁴² MECA commented that “the costs of the technologies needed to comply with the proposed standards have remained approximately consistent or have declined since . . . 2012.”⁸⁴³ Ceres stated that strong standards would spur cost learning and decrease manufacturer costs over time.⁸⁴⁴

AFPM argued that the proposal relied on electric vehicles, which cost more than comparable ICE vehicles, and which could become even more expensive if mineral supply chain issues are exacerbated.⁸⁴⁵ AFPM stated that NHTSA had not accounted for the extent to which manufacturers cross-subsidize EVs by increasing the prices of ICE vehicles.⁸⁴⁶ AFPM also stated that many sources show that lifetime ownership costs for EVs are higher than for ICE vehicles.⁸⁴⁷

Auto Innovators commented that the differences between the EPA and NHTSA programs “. . . make[] compliance with the NHTSA CAFE program more difficult and, at minimum, add complexity to product plans. These differences add costs, and . . . [w]e recommend that NHTSA consider these differences to the EPA program and their impacts on regulatory costs as part of its evaluation of the economic practicability of CAFE standards.”⁸⁴⁸

⁸⁴¹ Consumer Reports, Docket No. NHTSA–2021–0053–1576–A9, at 10–15.

⁸⁴² *Id.*

⁸⁴³ MECA, at 2.

⁸⁴⁴ Ceres, Docket No. NHTSA–2021–0053–0076, at 2.

⁸⁴⁵ AFPM, at 6–8.

⁸⁴⁶ *Id.*

⁸⁴⁷ *Id.*, at 9.

⁸⁴⁸ Auto Innovators, at 32.

In response, NHTSA does not believe that per-vehicle costs associated with any of the regulatory alternatives are significantly greater than per-vehicle costs considered economically practicable over the last several rulemakings. As compared to the baseline (*i.e.*, retention of the SAFE rule and an indefinite extension of that rule's MY 2026 standards), Alternative 1 would require, on average, an additional \$432 for MY 2029; Alternative 2, an additional \$938 for MY 2029; Alternative 2.5, an additional \$1,087 for MY 2029; and Alternative 3, an additional \$1,407 for MY 2029. Costs differ by manufacturer and by fleet (all in 2018 dollars), but these averages are illuminating.

NHTSA is aware that cross-subsidization happens across models and vehicle types, as AFPM noted, but assumes in this analysis (and all those preceding it) that costs for all technology are passed directly through to consumers. NHTSA lacks reliable information about cross-subsidization to estimate those effects more precisely; but nevertheless believes that the current approach is reasonable and provides useful information about average effects to decision-makers. Additional levels of detail would likely be necessary if NHTSA were attempting to develop and run a consumer choice model, but by itself, such a model would only address the potential demand-side *response* to any cross-subsidization. Estimating cross-subsidization would likely involve estimating manufacturers' respective approaches to vehicle prices and incentives, and possibly even manufacturers' respective approaches to distributing costs and earnings across global regions and business units, and among customers, employees, and investors. NHTSA currently lacks appropriate information that would be needed to account for all of these degrees of freedom and corresponding highly proprietary (and doubtlessly fluid) corporate strategies. Analogous to considering the potential for manufacturers to apply technology in a manner that holds vehicle performance and utility approximately constant, the agency considers it reasonable and appropriate to consider the potential that the industry could continue to follow long-standing average practices in passing along additional costs.

Some commenters have argued that the per-vehicle costs for all alternatives

are understated, because the analytical baseline for this rulemaking includes more technology application, and thus cost accrues in the baseline that NHTSA is effectively saying does not "count" for purposes of the CAFE standards. NHTSA discusses in Sections IV.B and VI.A.5.e) why NHTSA believes that it is reasonable and appropriate for the analytical baseline to reflect several manufacturers' voluntary commitment to higher (than finalized in 2020) GHG emissions reductions during the rulemaking time frame, and all manufacturers' anticipated compliance with ZEV mandates in California and the Section 177 states. The inclusion of these measures in the baseline reflects the reality of the market, a reality NHTSA is required to reflect in order to assess the effects of its standards. NHTSA agrees that automakers will apply technology in response to both of those, and that doing so will add cost to new vehicles, and that some of that technology will ultimately make CAFE compliance easier. However, the CAFE program is not the but-for cause of that technology application and those costs. NHTSA therefore disagrees that NHTSA must "own" those costs when determining what CAFE standards would be economically practicable or technologically feasible. NHTSA, like the automakers, is aware that the automakers are making technology application decisions with reference to many different things, including multiple regulatory regimes and non-regulatory commitments. The additional costs that CAFE compliance would require is the question that belongs to NHTSA.

With that in mind, NHTSA acknowledges the comment from Auto Innovators that compliance flexibility and other programmatic differences between NHTSA and EPA can make compliance with NHTSA's standards more binding (and thus, more costly) for some manufacturers in some model years. We understand that manufacturers would rather spend less money than more in complying with their various regulatory obligations, but manufacturers who plan to meet the most binding standards, whichever ones they are, will foreseeably be in a good compliance position with all other application standards. Moreover, we continue to believe that an additional average \$1,087 per vehicle as compared to the No-Action Alternative standards is economically practicable, and we

note that it is considerably less than the additional \$1,407 per vehicle estimated to be required under Alternative 3. It is also considerably less than the additional per-vehicle costs the agency considered to be economically practicable in 2012, when the industry was still recovering from the Great Recession. Although today's supply chain issues pose a new challenge to the industry, NHTSA considers it uncertain whether these will necessarily persist through the rulemaking time frame, and believes that they are uncertain enough that they should not be presumed. NHTSA also notes that the industry is far healthier today financially than it was a decade ago.

Related to per-vehicle costs (and arguably to sales), Auto Innovators commented that the payback period associated with many technologies modeled for compliance with Alternatives 2 and 3 was longer than NHTSA seemed to believe consumers would accept.⁸⁴⁹ Noting that NHTSA uses a 30-month payback for manufacturers' voluntary application of fuel-economy-improving technologies, Auto Innovators stated that:

The Central Case NHTSA analysis forecasts that, for Alternative 2, 27.4 [percent] of MY 2026 vehicles adopt fuel-saving technologies that take 8 or more years to pay back, and nearly 1 in 8 vehicles adopts technology that will not pay back in 16 or more years (if at all). For Alternative 3, with the Global Insight fuel price projections, 1 in 4 vehicles will take at least 12 years to pay back the cost of fuel-saving technologies, and over 40 [percent] of the fleet will include fuel-saving technologies that do not return investment until at least the 8th year of ownership and use. For Alternative 3, with the Global Insight fuel price forecast, 1 in 5 vehicles built in MY 2026 includes technology that will not pay back in the first 15 years of ownership and operation. If consumers are reluctant to adopt these technologies, the policy objectives of the higher stringency alternatives may not be fully realized.⁸⁵⁰

NHTSA fully agrees that if consumers are reluctant to adopt these technologies, the policy objectives of the standards may not be fully realized. Having updated some aspects of its analysis, NHTSA currently estimates that fuel-saving technology added in response to the new CAFE standards in MY 2026 could take 5.5–7.5 years to pay off (depending on whether taxes, fees, financing, and insurance are accounted for), but that by MY 2029, this technology could pay off in 4.5–5.5 years:

⁸⁴⁹ Auto Innovators, at 15.

⁸⁵⁰ *Id.*, at 52.

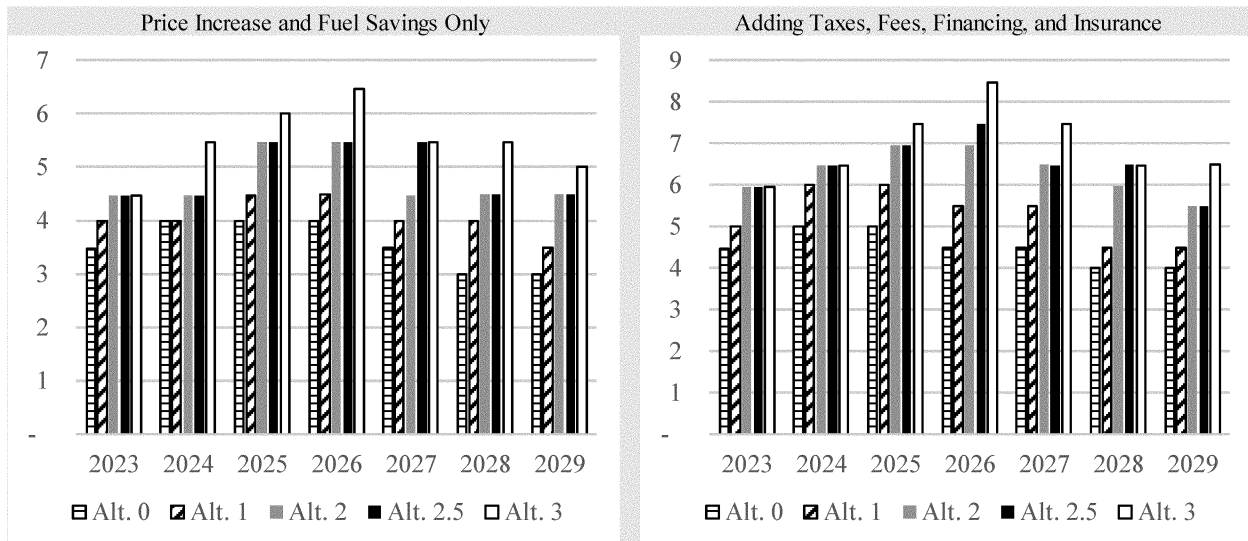

Figure VI-2 – Estimated Payback Period for Additional Technology (beyond MY 2020)

Setting aside taxes, fees, financing, and insurance, NHTSA finds that under alternative 2.5, payback periods are all within the estimated vehicle age (6 years) at which vehicles are first sold to used vehicle buyers, and even within the estimated average new vehicle loan term (5.75 years).

That said, NHTSA disagrees that there is an inherent conflict between NHTSA's analytical assumption for purposes of the baseline that *manufacturers* can reasonably be expected to improve fuel economy voluntarily if the technology pays for itself in 30 months, and the possibility in the real world that consumers will still buy vehicles with improved fuel economy that take considerably longer to pay back in fuel savings. As we explained above, the assumption about voluntary payback may be less valid when all vehicles are subject to fuel economy regulations. Moreover, for decades, manufacturers have included catalytic converters that offer owners no direct financial benefit at all (and that, conversely, can be expensive to replace), and consumers have continued to buy new vehicles. Manufacturers have made significant quality improvements in new vehicles over the past decades, and consumers are retaining vehicles longer than ever before, meaning that many consumers will experience more of the lifetime fuel savings from their new vehicles than they may have experienced previously, and be more willing to shoulder additional up-front costs in order to obtain those fuel savings over time. Although the payback periods shown

above are nearing (or somewhat exceeding, if taxes, fees, financing, and insurance are considered) the term of the average new vehicle loan, the current economic forecast informing NHTSA's analysis indicates buyers' wealth will likely continue to increase over time, with per-capita real disposable income increasing by 20 percent between 2022 and 2030. In that case, buyers will be better able to afford the additional up-front costs resulting from this rule, and drivers (if not necessarily initial buyers) will continue to realize significant fuel savings long after recouping those up-front costs. Finally, when new car buyers do get ready to sell their cars into the used car market, they should be able to recoup some of the cost of the fuel economy technologies.

A number of commenters addressed lead time—the extent to which standards may or may not be economically practicable based on how long they give manufacturers to make necessary changes to their vehicles. Tesla commented that lead time is not a problem for several reasons: First, because credit trading and banking builds in flexibility; second, because the majority of the industry signed on to the 2012 standards with commitment letters, so the industry has been on notice of the possibility of more stringent standards; third, that because manufacturers are following the California and Section 177 states' GHG standards, they have had plenty of lead time to meet stricter CAFE standards; and fourth, because Tesla has been

selling EVs consistently over the past several model years.⁸⁵¹

Securing America's Future Energy stated that their analysis showed that “each of the top 15 vehicle programs produced in the United States are expected to transition to a new program before 2030. In fact, . . . most of the conventional vehicles that will be produced in the United States in 2030 are part of programs that are early enough in their production cycles that the automakers can transition the program to electric platforms without stranding investment.”⁸⁵²

Our Children's Trust commented that 18 months (as required by statute for new standards) was plenty of lead time, and NHTSA should “[p]ut the industry on notice today that it needs to move to a 100 [percent] electric or clean fleet by 2030.”⁸⁵³ South Coast AQMD similarly cited EPCA's 18 month lead time requirement as adequate even for Alternative 3, and like Tesla argued essentially that industry had been on notice since the 2012 final rule that standards as stringent as Alternative 3 were possible.⁸⁵⁴ South Coast AQMD further commented that “the technology to meet [Alternative 3] exists today, and the current trend of manufacturers daily adding to the announcements of increasing investment all allow NHTSA confidence that there is not a lead time

⁸⁵¹ Tesla, A1, at 7–8.

⁸⁵² Securing America's Future Energy, at 7–8.

⁸⁵³ Our Children's Trust, Docket No. NHTSA–2021–0053–1587, at 1–2.

⁸⁵⁴ South Coast AQMD, at 4.

concern with the ability to meet Alternative 3 standards.”⁸⁵⁵

In contrast, Kia stated that “[f]our years is a short time for vehicle redesigns and extremely short for full engine and powertrain redesigns. . . . it is unlikely that [more fuel-efficient engine/powertrain architectures] would permeate our entire fleet at the levels NHTSA suggests. Thus, the engineering burden would fall on a combination of changes to the smaller set of vehicles that could be redesigned in time, and potential fleet mix changes where those other actions fall short.”⁸⁵⁶ Stellantis similarly commented that “[i]t takes the automotive industry (and Stellantis) 2 to 4 years to introduce a new product. . . . OEMs have historically justified powertrain business cases over at least a ten-year time horizon. . . . To achieve [zero emissions], focus must remain on transformational electrification investments, starting now in order to minimize the time and maximize the success of this transition.”⁸⁵⁷ Stellantis noted that the 2020 EPA Automotive Trends Report showed that “11 of 14 major manufacturers underperformed their MY2019 standard and relied on the use of banked or purchased credits,” stating that “[t]his is a clear indication that the additional time afforded in the proposed rule is needed to grow the market demand for more efficient electric vehicles, before even more stringent standards, requiring higher rates of electrification, can be implemented.”⁸⁵⁸

Auto Innovators disagreed with NHTSA’s suggestion in the proposal that the 1.5 percent increases in CAFE

stringency over MYs 2021–2023 represented any kind of “break,” and commented that the proposal showed Alternative 2 requiring “significant technology additions as soon as MY 2023 (including large numbers of EVs) to support compliance in MYs 2024–2026, despite MY 2023 potentially beginning as soon as two months from now for some vehicle models, and more generally about nine months from now for most.”⁸⁵⁹ Auto Innovators continued that “While NHTSA may technically be providing the statutorily required 18-month lead time for increasing standards, the actual lead time to achieve the improvements modeled by NHTSA is much less.”⁸⁶⁰

In response, while lead time is not an express factor for NHTSA under EPCA as it is for EPA under the CAA, NHTSA still believes lead time is appropriately considered as part of economic practicability. NHTSA has long recognized that the statutory 18-month lead time is shorter than manufacturer product cycles, while also recognizing that it is the minimum amount of lead time that Congress required for new or amended (more stringent) standards. NHTSA understands that more lead time is always preferable from an industry perspective. Lead time has factored into our maximum feasible analysis by increasing the stringency of the standards in the last MY of our rule so that manufacturers will have close to four years to achieve the highest stringency.

That said, NHTSA continues to believe that the lead time for the final standards is adequate. NHTSA agrees with some commenters’ suggestions that

the U.S. auto industry has been generally aware since 2012 of potential stringency levels in the rulemaking time frame that would have been even higher than those that NHTSA is now finalizing. Automakers in 2012 were planning to achieve these levels; what happened in the interim was lower gasoline prices than anticipated and the continuing trend of U.S. consumers generally choosing new vehicles with lower fuel economy rather than higher fuel economy (perhaps encouraged by advertising campaigns touting larger vehicles, which generally produce larger profit margins for manufacturers). Manufacturers who petitioned the Federal Government to reconsider the EPA 2018 Final Determination may have been hoping for less stringent standards that reflected the vehicles they were actually selling in high volumes, rather than the vehicles they were developing with an eye toward future CAFE/GHG/ZEV stringency increases, and NHTSA set lower standards in 2020 for MYs 2021–2026 in response to that petition. Technologically, NHTSA does not believe that automakers ever really got that far “off track” from the original intent of the 2012 standards, or they would not be in a position today to be constantly announcing and rolling out new higher-fuel-economy vehicle models. Shifting back to the perspective of lead time, the question may be less about whether automakers have enough time to make *technological changes* in their fleets, and more, as Kia suggested, whether automakers have enough time to spread *technology they already have* throughout enough of their fleets so that their average fuel economy tracks their anticipated compliance obligations.

⁸⁵⁵ *Id.*

⁸⁵⁶ Kia, at 3.

⁸⁵⁷ Stellantis, at 15.

⁸⁵⁸ *Id.*, at 14.

⁸⁵⁹ Auto Innovators, at 15.

⁸⁶⁰ *Id.*, at 53–54.

Table VI-5 – Penetration Rates (%) for Select Technologies Across All Manufacturers During the Rulemaking Timeframe

Technology	Alternative	2020	2021	2022	2023	2024	2025	2026
Turbocharging with Cylinder Deactivation	2.5	2.0	5.7	9.8	13.0	14.6	16.8	22.3
	3	2.0	5.7	9.8	12.9	14.2	15.7	19.3
	Δ Alt 3 - Alt 2.5	0.0	0.0	0.0	-0.1	-0.4	-1.1	-3.1
Ten-Speed Transmission	2.5	10.4	15.8	28.7	34.5	40.9	41.4	39.1
	3	10.4	15.8	28.7	34.6	39.1	39.3	37.6
	Δ Alt 3 - Alt 2.5	0.0	0.0	0.0	0.1	-1.8	-2.1	-1.5
Mild Hybrid	2.5	1.9	1.9	1.8	2.4	2.9	3.2	4.3
	3	1.9	1.9	1.8	2.1	2.4	2.7	3.8
	Δ Alt 3 - Alt 2.5	0.0	0.0	0.0	-0.3	-0.5	-0.5	-0.5
Strong Hybrid	2.5	2.8	3.9	4.6	5.7	10.8	15.3	20.9
	3	2.8	3.9	4.6	6.7	14.3	18.3	24.2
	Δ Alt 3 - Alt 2.5	0.0	0.0	0.0	1.0	3.5	3.0	3.3
Highest Level of Aerodynamic Drag Reduction	2.5	3.3	5.8	10.8	15.7	23.9	32.6	41.3
	3	3.3	5.8	10.8	16.6	26.1	35.4	45.2
	Δ Alt 3 - Alt 2.5	0.0	0.0	0.0	0.9	2.3	2.8	3.9

Table VI-5 summarizes the fleetwide penetration rates for certain technologies from MYs 2020 through 2026. While the regulatory alternatives considered in this final rule require not- insignificant application of additional technology, particularly the more stringent alternatives, all of these technologies exist in the fleet today. The first two rows—turbocharging with cylinder deactivation and ten-speed transmissions (the highest number of speeds modeled)—are ICE-improvement technologies already available on vehicles today. The model estimates that the average rate of application for turbocharging with cylinder deactivation could increase from roughly 2 percent in MY 2020 to over 20 percent on average across the industry in MY 2026 in response to Alternatives 2.5 and 3, but this is still adding an existing ICE technology to just over 20 percent of vehicles. The model estimates that the average rate of application for ten-speed transmissions could increase from roughly 10 percent in MY 2020 to nearly 40 percent on average across the industry in MY 2026 in response to Alternatives 2.5 and 3. While this penetration rate may seem high, it is much lower than previous expectations about advanced transmission penetration rates in prior rulemakings, and again, is the projected

rate increase applies across the entire industry, during a time frame in which plenty of vehicles will be redesigned and a new transmission or powertrain could reasonably be incorporated. Mild hybrids are estimated to increase from barely 2 percent to roughly 4 percent. Strong hybrids and high levels of aerodynamic improvements require more extensive architectural changes to vehicles, and may be more challenging than the other listed technologies to apply more widely during the rulemaking time frame, but again, this is industry-wide; many redesigns will occur during these model years; and manufacturers are always free to chart their own technology paths to compliance. Standards may be challenging without being economically impracticable, and NHTSA believes that that is the case here.

Consumer Demand, Electrification, Net Benefits

With regard to uncertainty regarding consumer acceptance (considered through the lens of economic practicability, which is concerned in part with automakers' ability to sell the vehicles called for by the standards), some commenters expressed optimism that consumers will respond favorably. Consumer Reports stated that their research suggests that consumers would prefer higher fuel economy in their next

vehicles, and stated that “[a] 2020 nationally representative survey . . . found that 73 [percent] of respondents said the federal government should continue to increase fuel economy standards.”⁸⁶¹ EDF echoed these points, stating that “64 [percent] of consumers rank fuel economy as extremely important or very important in considering what car to purchase,” and that “research has shown that consumers are willing to pay more for improvements to fuel economy than for improvements to acceleration or premium trim.”⁸⁶² Consumer Reports argued further that “[t]here is inherent inequity in the car marketplace as Consumer Reports’ research has found that new car buyers are predominantly wealthier, whiter, and older, and they determine what vehicles end up on the used car market. Expanding consumers’ choices of fuel-efficient vehicles will also benefit those that cannot afford to enter the new car market.”⁸⁶³

Some commenters stated that strong standards would themselves create demand: Securing America’s Future Energy commented that automakers “cannot [be expected] to make cars for

⁸⁶¹ Consumer Reports, Public Hearing Comments, at 1.

⁸⁶² EDF, at 5.

⁸⁶³ Consumer Reports: Public Hearing Comments, at 1.

which there is not a promising market,” but that “the power of the government’s regulatory authority . . . can be used to shape the market. This rulemaking offers the federal government a valuable opportunity to exercise its regulatory authority to accelerate the growth of that market.”⁸⁶⁴ South Coast AQMD commented that DOE’s “technology targets for battery costs and electric drive technologies,” “the commitment of the federal government to purchase ZEVs for government fleets,” and “President Biden’s target of 50 [percent] of new vehicles being ZEVs by 2030” will all drive demand, in addition to California’s announcement of the 100 percent ZEV target for 2035.⁸⁶⁵

Some commenters argued that strong standards would enhance U.S. automakers’ global competitiveness: ACEEE commented that strong standards “provid[e] consumers a wider array of vehicle choices,” and improve U.S. automakers’ global competitiveness.⁸⁶⁶ Ceres also supported the idea that Alternative 3 would improve U.S. global competitiveness.⁸⁶⁷

Other commenters expressed concern about consumer demand for fuel economy. NADA, for example, commented that consumers are “far from being myopic or inconsistent,” and will continue to purchase CUVs, SUVs, and trucks rather than passenger cars as long as fuel prices remain low, which AEO continues to forecast.⁸⁶⁸ NADA argued that “NHTSA’s current proposal is flawed in that, as with the 2012 joint rule, the agency has not adequately considered critical demand-side marketplace factors, including whether OEMs will be able to make and deliver compliant vehicles that are both marketable and affordable.”⁸⁶⁹ NADA also commented that “. . . given that many OEMs were unable to comply with pre-SAFE Rule CAFE standards since at least MY 2016 (but for the application of credits), serious questions exist regarding their ability to meet the standards NHTSA has proposed in a cost effective, economically practicable manner sufficient to bring to market light duty vehicles that preserve consumer choice and feature preferences.”⁸⁷⁰

Mr. Kreucher similarly commented that “[b]ased on [his] professional

experience, CAFE standards have a major impact on the automotive choices available to consumers and on the purchase prices of various models. . . . especially . . . when fuel prices are relatively low, because low-priced gasoline forces many carmakers to adjust prices and model availability so that new car purchases produce a sales mix that complies with CAFE.”⁸⁷¹ Mr. Kreucher pointed to recent cuts in Ford’s passenger car lineup as evidence that CAFE standards reduce consumer choice and argued that “it is likely that our car-buying choices would be even broader, and car prices would be even lower, if the agencies adopted standards that were even more lenient than what they chose in the proposed rule.”⁸⁷²

Mr. Douglas disagreed that consumer acceptance should even be a consideration, stating that “[e]conomic practicability and economic desirability are two different things, and there is nothing in the relevant governing statutes directing [NHTSA] to full satisfy auto consumers at all cost.”⁸⁷³ Mr. Douglas went on to argue that “[i]t is unreasonable to set stringency so low that the regulatory framework produces slow fuel economy improvements that fail to reduce overall gasoline consumption at an adequate pace, knowing that we could do much better by forcing consumers to moderate their desires and choose from greener options.”⁸⁷⁴ Mr. Douglas commented that it is evident in EPCA that Congress intended some consideration of consumer choice, as through the setting of separate standards for cars and trucks, the use of attribute-based standards defined by a mathematical formula, and the low-volume exemption.⁸⁷⁵ However, he concluded that the statutory evidence did not suggest that Congress meant for consumer demand to be a brake on stringency,⁸⁷⁶ stating that “[i]t is economically practicable to disappoint consumers somewhat, and there are less desirable vehicle options that would significantly reduce the technological barriers that are preventing meaningful fuel economy improvements. These feasibility barriers are not written in stone.”⁸⁷⁷ Mr. Douglas suggested that automakers could easily shift their fleet mixes or reduce vehicle weight or horsepower to increase fuel economy

levels quickly, and that this would not be economically impracticable.⁸⁷⁸

In response, NHTSA points again to case law finding it reasonable to consider consumer demand as a component of economic practicability.⁸⁷⁹ Uncertainty about consumer demand is still a reasonable consideration within economic practicability, albeit one that is getting somewhat more complicated to parse as industry and government head toward higher and higher levels of fleet fuel economy requirements.

NHTSA agrees that automakers have been relying more heavily on banked credits for compliance over the last few model years. NHTSA also agrees with the observation that American consumers purchased larger and heavier vehicles, on average, than previously expected. This is evident in the compliance data for both the CAFE and CO2 programs. NHTSA does not agree that automakers reducing passenger car offerings is necessarily due to CAFE stringency, however. The standards were designed to enable automakers to bank compliance credits as a compliance flexibility, and reliance on those banks means automakers are using program flexibilities in order to optimize their compliance strategies and reduce costs. It does not indicate that the standards are infeasible. There is a chicken and egg question here, in which consumers seek out larger and heavier vehicles when gas prices are relatively low; automakers continue to offer those vehicles—and indeed, market them heavily—and (in some cases) discontinue smaller and more fuel-efficient models going forward; this marketing strategy can and should adjust to facilitate compliance with CAFE standards that were predicated on (among other things) the potential to offer smaller and more fuel-efficient models, even when controlling for the effects of the footprint-based standards and separate standards for passenger cars and light trucks. Meanwhile, automakers also continue to roll out very high-fuel-efficiency models, some of which are very popular with consumers, even while other groups of consumers continue to buy the large, heavy, more traditional ICE models. American consumers today do have quite a wide array of light-duty vehicle options, many of them with higher fuel economy than ever before, along with other attributes that they value. This is

⁸⁶⁴ Securing America’s Future Energy, at 2–3.

⁸⁶⁵ South Coast AQMD, at 5.

⁸⁶⁶ ACEEE, Docket No. NHTSA–2021–0053–0074, at 1–2.

⁸⁶⁷ Ceres, at 1.

⁸⁶⁸ NADA, Docket No. NHTSA–2021–0053–1471, at 8–9.

⁸⁶⁹ *Id.*, at 5–6.

⁸⁷⁰ *Id.*

⁸⁷¹ Walter Kreucher, Docket No. NHTSA 2021–0053–0013, at 13.

⁸⁷² *Id.*, at 12.

⁸⁷³ Peter Douglas, Docket No. NHTSA–2021–0053–0085, at 4.

⁸⁷⁴ *Id.*, at 5.

⁸⁷⁵ *Id.*, at 21.

⁸⁷⁶ *Id.*

⁸⁷⁷ *Id.*, at 4.

⁸⁷⁸ *Id.*

⁸⁷⁹ *CAS*, 793 F.2d 1322 (D.C. Cir. 1986) (Administrator’s consideration of market demand as component of economic practicability found to be reasonable).

confirmed by recent data from Wards Intelligence, as summarized by the Energy Information Administration. EIA states that “[s]ales of several existing hybrid, plug-in hybrid, and electric models increased in 2021, but a large portion of the sales increase came from new manufacturer offerings across different market segments. Manufacturers increased the number of non-hybrid ICE vehicle models by 49 in 2021, versus an increase of 126 for hybrid and electric vehicle models.”⁸⁸⁰ EIA also notes that “Manufacturers of hybrid vehicles and plug-in vehicles have expanded into market segments such as crossovers, vans, and pickups following consumer preference for larger vehicle. Within each electric or hybrid powertrain type, crossover vehicles now account for most sales.”⁸⁸¹ While, again, NHTSA does not and is not considering electrification in deciding on the maximum feasible fuel economy standards, consistent with 49 U.S.C. 32902(h), it is crystal clear that these trends are occurring even in the absence of further NHTSA action.

The question at the root of uncertainty about consumer demand is whether the standards will require automakers to change their vehicles or lineups in ways that affect sales and employment to such an extent that it makes the standards economically impracticable. As Mr. Douglas suggested in his comments, *some* change is not economically impracticable, because (other than during the pandemic) vehicle sales have been climbing steadily since the recession in 2008,⁸⁸² a period during which CAFE standards generally have also been rising. Consumers have not yet stopped buying new vehicles because CAFE standards have become more stringent, and they still have many different vehicle options from which to choose, and many of those different vehicle options include improved fuel economy levels—but not all.

NADA’s comments suggest that as standard stringency continues to increase, automakers will have a choice between making compliant vehicles, and vehicles that are marketable and affordable—in effect, that compliant vehicles will *not* be marketable and affordable. NHTSA agrees that

affordability is a major concern generally, but does not find it to be a concern for this rulemaking, as evidenced by the per-vehicle cost discussion above. Moreover, auto dealers have managed to keep sales levels increasing in recent years (again, excluding the years affected by the pandemic) even while the average per-vehicle price has increased.⁸⁸³ The 2020 final rule discussed the phenomenon of lengthening loan terms for new vehicles and expressed concern about a possible bubble, but even with average prices at their highest recorded levels, demand is currently still outstripping supply and, as mentioned above, current economic forecasts show real disposable income continuing to increase between now and 2030.

Thus, given that per-vehicle cost increases attributable to CAFE standards do not seem insurmountable during the rulemaking time frame, the next question is whether the technology itself seems likely to reduce consumer demand for new vehicles such that auto industry sales and employment fall to economically impracticable levels. Again, NHTSA does not believe that this is likely during the rulemaking time frame. The agency estimates that, compared to the No-Action Alternative, this rule could involve the increased application of a range of technologies, such as improvements to engine friction, vehicle mass efficiency, aerodynamics, and automatic transmissions; turbocharged or high compression ratio engines; as well as some additional deployment of hybrid-electric vehicles. Although dual-clutch transmissions clearly did not succeed as anticipated in past NHTSA rulemakings, most of these other technologies have already enjoyed some level of success in the marketplace, and the agency is aware of no indications that the future market will not accept such technologies in due course. Moreover, automakers themselves are steadily announcing higher fuel economy models, and NHTSA continues to believe that sophisticated, for-profit companies would not offer, much less tout, vehicles that they do not believe are marketable.

A number of commenters directly addressed NHTSA’s suggestions in the proposal that the proposed standards could be economically practicable based on automaker announcements and commitments regarding forthcoming higher-fuel-economy vehicle models. Among commenters agreeing with NHTSA, Lucid stated that “the rapidly

decreasing costs of battery production, the commitments already made by many automakers to increase electrification and technology in their vehicles, and the incentives for EV purchases in place in several states suggest that Alternative 3 is economically practicable.”⁸⁸⁴ Tesla also agreed with NHTSA that industry announcements “are indicative of broader interest and capabilities in achieving greater fuel economy and that more stringent standards are economically practica[ble].”⁸⁸⁵ Tesla further commented that the proposed standards are “being eclipsed by . . . real world [manufacturer] plans, capabilities, and consumer-driven investments.”⁸⁸⁶

NCAT noted extensive investment by its members in electrification technologies and stated that “[t]he regulations [that have helped spur those investments] and resulting investments will stimulate technology innovation and market competition, enable consumer choice, attract private capital investments, and create high quality jobs.”⁸⁸⁷ General Motors Company (GM) touted its announcements about and investments in ZEVs, stating that “[e]ven as we manage short-term challenges like COVID-19 and the semiconductor shortage, we continue to accelerate our investment in EVs.”⁸⁸⁸

In contrast, Honda stated that “while commitments are serious, sincere, and very much underway, it is important that the agencies not approach such announcements as foregone conclusions. Limited market adoption of technology necessary for reaching our future climate goals presents a profoundly challenging and still uncertain industry transition for the automotive industry in the years ahead.”⁸⁸⁹ Honda further commented that “[t]hese challenges are only amplified by present headwinds; as widely reported in the media over the past 18 months, the automobile industry is facing severe global supply chain issues that continue to disrupt vehicle production volumes, launch dates and compliance strategies. Should ongoing supply chain issues persist well into the next year, development schedules and profits could be impacted.”⁸⁹⁰ Kia also noted supply chain issues, and argued

⁸⁸⁰ EIA, “Today in Energy: Electric vehicles and hybrids surpass 10% of U.S. light-duty vehicle sales,” Feb. 9, 2022. Available at <https://www.eia.gov/todayinenergy/detail.php?id=51218> (accessed March 15, 2022).

⁸⁸¹ *Id.*

⁸⁸² “Light vehicle retail sales in the United States from 1976 to 2021,” <https://www.statista.com/statistics/199983/us-vehicle-sales-since-1951/> (accessed March 15, 2022).

⁸⁸³ <https://www.kbb.com/car-news/average-new-car-price-tops-47000/>, (accessed March 15, 2022).

⁸⁸⁴ Lucid, Docket No. NHTSA–2021–0053–1584, at 4.

⁸⁸⁵ Tesla, at 5.

⁸⁸⁶ *Id.*

⁸⁸⁷ NCAT, Docket No. NHTSA–2021–0053–1508, at 5.

⁸⁸⁸ GM, Docket No. NHTSA–2021–0053–1523, at 2–3.

⁸⁸⁹ Honda, Docket No. NHTSA–2021–0053–1501, at 8–9.

⁸⁹⁰ *Id.*, at 9.

that accounting for manufacturer announcements “without a full-scale cost-benefit analysis may pose gaps that have longer-term consequences,” stating that “[i]t is of critical importance that NHTSA assures that a full impact of the COVID–19 pandemic has been incorporated into its model . . . [and] NHTSA . . . continue[s] to add refinements to this aspect of the model, as the far-reaching supply-chain implications continue to reveal themselves.”⁸⁹¹

Somewhat distinct but also related, several commenters also discussed NHTSA’s statements in the proposal that the California Framework Agreements represented evidence of economic practicability. Southern Environmental Law Center (SELC) and South Coast AQMD both agreed with this assessment. SELC stated that Alternative 3 could be economically practicable because “vehicle manufacturers have taken numerous steps that indicate increased fuel economy is both possible and profitable,” and cited the Framework Agreements and new high-fuel-economy product launches as evidence of market interest in fuel economy and changing consumer preferences.⁸⁹² South Coast AQMD agreed that “no for-profit auto manufacturer would voluntarily agree to results which were either technologically infeasible or economically impracticable. Thus, NHTSA can be confident that the fuel economy consequences of these emission Agreements would be feasible and practicable. But that establishes a floor, not a ‘maximum feasible’ ceiling.”⁸⁹³

Conversely, NADA argued that “. . . the fact that a select few OEMs entered into voluntary agreements with the State of California regarding GHG emissions mandates moving forward and/or have announced aspirational targets to become carbon neutral or to aggressively market ZEVs should have no bearing on whether the revised CAFE mandates NHTSA has proposed will be technologically feasible or economically practicable.”⁸⁹⁴ While Honda agreed with NHTSA that the Framework Agreements made “good business sense,” Honda argued that “important flexibilities [are] needed to reach those targets.”⁸⁹⁵ Honda continued that “Given the significant structural differences between the California

Framework Agreement[s] and the CAFE program, it would be inappropriate for NHTSA to assume that a commitment to one program suggests a level of contentment with the other.”⁸⁹⁶ Tesla argued that it was incomplete for NHTSA to say that the Framework Agreements demonstrate manufacturer capability of meeting the standards, because “[t]he agency fails to acknowledge that some manufacturers may have entered into the Framework Agreements not because of technology capabilities, but as an opportunistic hedge and safe harbor from the more rigorous California GHG standards should the SAFE rule’s rescinding of California’s Advanced Clean Cars waiver been found to be illegal.”⁸⁹⁷ Honda also disagreed that the Framework Agreements were necessarily evidence of consumer demand for fuel economy. Honda stated that “[w]hile market interest is an important driver, the role of regulatory requirements cannot be ignored. . . . for many years, Honda and other automakers have been communicating their views to regulatory agencies about the disconnect between rapidly escalating [ZEV] sales mandates and the limited consumer uptake of electric vehicles, which currently average about 2 percent in the United States.”⁸⁹⁸

In response, regardless of what is driving manufacturer announcements and voluntary commitments to raising their fleet fuel economy levels and reducing fleet emissions in the coming years, the turning of the tide among automakers is still plainly obvious. Nearly every manufacturer has made repeated public statements and commitments to continue improving fuel economy in the coming years, and have also committed to electrification. These statements have been made despite uncertainty about Government commitments like subsidies and tax credits to facilitate demand for higher-fuel-economy vehicles, and in the absence of forecasted increases in fuel prices that would also improve such demand.

NHTSA recognizes that the California Framework Agreements may not represent the economic practicability of achieving those emissions levels for the industry as a whole, even if they may represent a level of economic practicability for the signatory companies. NHTSA also recognizes that the Framework Agreements are emission reduction commitments, not fuel economy standards, and that the

Agreements will likely be met with some technologies that also improve fuel economy, as well as some technologies that are irrelevant to fuel economy but reduce emissions, and some technologies—such as ZEV—that NHTSA cannot consider the fuel economy of in assessing what is maximum feasible. Nonetheless, the Framework Agreements do provide information about the economic practicability of technologies that both improve fuel economy and reduce emissions. Further, the automakers who did not sign on to the Framework Agreements, have made repeated public statements and commitments about enhancing fuel economy. South Coast AQMD commented that while in the proposal, NHTSA expressed concern that Alternative 3 may not have been economically practicable due to cost, manufacturers have “repeatedly and voluntarily doubled-down on investing in the very technology that makes these standards achievable.”⁸⁹⁹ South Coast AQMD continued:

That manufacturers are already committing to the necessary investments is . . . overwhelming evidence that this investment is not only well within any reasonable definition of practicable, but is *preferable* to maximize profits. Even where Alternative 3 may require certain manufacturers to accelerate the rate of deploying technological advancements, this would not make Alternative 3 economically impracticable. In fact, that would serve the very purpose of the CAFE standards—to push forward the goal of fuel conservation, even faster than the market would arrive at otherwise.⁹⁰⁰

NHTSA agrees. For-profit companies cannot make decisions contrary to profit and survive indefinitely in the marketplace. The logical conclusion must be that the companies believe that one way or another, they will benefit financially from investing in technologies that improve fuel economy. But NHTSA continues to believe that these commitments are not idle, and that they are evidence of manufacturers’ belief that higher-fuel-economy vehicles are saleable.

Nevertheless, in the interest of not adding undue burden to manufacturers seeking to make this transition, and recognizing the ongoing and very real supply chain issues that are still evolving, NHTSA continues to believe that the most stringent Alternative, Alternative 3, is likely to be beyond economically practicable for the rulemaking time frame. While this will be discussed in more detail in Section VI.D below, Alternative 2.5 provides

⁸⁹¹ Kia, at 4–5, 9–10.

⁸⁹² SELC, Docket No. NHTSA–2021–0053–1495, at 5.

⁸⁹³ South Coast AQMD, at 3.

⁸⁹⁴ NADA, at 5.

⁸⁹⁵ Honda, at 7–8.

⁸⁹⁶ *Id.*, at 8.

⁸⁹⁷ Tesla, A1, at 8.

⁸⁹⁸ Honda, at 8.

⁸⁹⁹ South Coast AQMD, at 4.

⁹⁰⁰ *Id.*, at 4–5.

more lead time and more breathing room in response to the uncertainty concerns raised by manufacturer commenters. NHTSA seeks in setting these CAFE standards to take advantage of the clear momentum of industry's transition to higher levels of fuel economy while respecting different challenges among different automakers.

With regard to net benefits, South Coast AQMD commented that NHTSA had not explained in the NPRM how negative net benefits for Alternative 3 “would unreasonably limit consumer choice or lead to a significant loss of jobs.”⁹⁰¹ SELC argued that if NHTSA would switch its cost-benefit analysis approach entirely to CY instead of MY, it would be very clear that Alternative 3 has higher societal benefits and would be economically practicable.⁹⁰² Ceres commented that their analysis indicated that higher standards led to higher automaker profits, “assuming high fuel prices during the regulatory period.”⁹⁰³ Our Children's Trust commented that

NHTSA should not use cost-benefit analysis in its decision-making at all, as “it favors adults and industry today over the lives of children and whether they have a livable planet as they become adults and live out their lives.”⁹⁰⁴

In response, NHTSA uses cost-benefit analysis as one consideration among many in determining maximum feasible CAFE standards. Regulatory analysis is a tool used to anticipate and evaluate likely consequences of rules. It provides a formal way of organizing the evidence on the key effects that can be monetized, positive and negative, of the various regulatory alternatives, and helps to inform decision-makers some of the potential consequences of choosing among the considered regulatory paths. NHTSA's use of cost-benefit analysis as a tool in CAFE rulemaking has been upheld in case law.⁹⁰⁵

As discussed elsewhere in this preamble, NHTSA updated its analysis for this final rule. After NHTSA completed these updates, a Federal

judge in the Western District of Louisiana enjoined Federal defendants from using the global social cost of carbon value developed by the IWG.⁹⁰⁶ NHTSA revised its analysis to follow the court order, using the values for the SC-GHG as used in the 2020 final rule, and discounting the 2020 value at both 3 percent and 7 percent. The 2020 value is a severe underestimate of actual climate damages, both because it does not reflect global damages and because it is not a robust assessment of damage to the United States. As such, the estimate is inappropriately low for use in the current analysis. However, using that severe underestimate of the SC-GHG, NHTSA found that, under a “model year” accounting approach, resulted in all regulatory alternatives indicating net costs in MY 2029, except for Alternative 1 at a 3 percent discount rate with the SC-GHG also discounted at 3 percent, for which NHTSA estimated net benefits of \$8.1 billion.

BILLING CODE 4910-59-P

⁹⁰¹ South Coast AQMD, at 5–6.

⁹⁰² SELC, at 6.

⁹⁰³ Ceres, at 2.

⁹⁰⁴ Our Children's Trust, at 2.

⁹⁰⁵ *Center for Biological Diversity v. NHTSA*, 538 F.3d 1172, 1188 (9th Cir. 2008).

⁹⁰⁶ *Louisiana v. Biden*, Order, No. 2:21-CV-01074, ECF No. 99 (W.D. La. Feb. 11, 2022).

Table VI-6 – Model Year Accounting, Comparison of Monetized Costs and Benefits of Regulatory Alternatives (Using Values from 2020 Analysis)⁹⁰⁷

	Alt. 1	Alt. 2	Alt. 2.5	Alt. 3
3% SC-GHG DR, 3% Social DR				
Total Social Costs	58.6	113.9	128.4	165.8
Social Benefits				
Private Benefits	62.7	101.7	113.8	143.4
Non-Climate External Benefits	2.1	3.1	3.3	4.0
Reduced Climate Damages	2.0	3.3	3.7	4.7
Total Social Benefits	66.7	108.1	120.8	152.1
Net Social Benefits	8.1	-5.8	-7.5	-13.6
3% SC-GHG DR, 7% Social DR				
Total Social Costs	43.0	84.9	95.8	124.3
Social Benefits				
Private Benefits	38.8	62.9	70.3	88.8
Non-Climate External Benefits	1.2	1.8	1.9	2.3
Reduced Climate Damages	2.0	3.3	3.7	4.7
Total Social Benefits	42.0	68.0	76.0	95.7
Net Social Benefits	-1.0	-16.9	-19.8	-28.5
7% SC-GHG DR, 7% Social DR				
Total Social Costs	43.0	84.9	95.8	124.3
Social Benefits				
Private Benefits	38.8	62.9	70.3	88.8
Non-Climate External Benefits	1.2	1.8	1.9	2.3
Reduced Climate Damages	0.2	0.4	0.4	0.5
Total Social Benefits	40.3	65.0	72.7	91.6
Net Social Benefits	-2.7	-19.9	-23.1	-32.7

Under a “calendar year” accounting approach, net benefits were estimated to be positive for Alternative 1, and for Alternatives 2, 2.5, and 3, appear

generally to straddle zero, with net benefits at a 3 percent discount rate and the 2020 value discounted at 3 percent, and net costs at a 3 or 7 percent

discount rate and the 2020 value discounted at 7 percent.

⁹⁰⁷ This table uses SC-GHG values from the 2020 final rule. This value does not fully reflect global climate damages and is not a robust assessment of damage to the United States. Additionally,

monetized values do not include other important unquantified effects, such as certain climate benefits, certain energy security benefits, distributional effects, and certain air quality

benefits from the reduction of toxic air pollutants and other emissions, among other things.

Table VI-7 – Calendar Year Accounting, Comparison of Monetized Costs and Benefits of Regulatory Alternatives (Using Values from 2020 Analysis)⁹⁰⁸

	Alt. 1	Alt. 2	Alt. 2.5	Alt. 3
3% SC-GHG DR, 3% Social DR				
Total Social Costs	165.3	324.0	366.8	466.7
Social Benefits				
Private Benefits	182.4	327.1	370.0	459.9
Non-Climate External Benefits	6.5	10.8	11.9	14.3
Reduced Climate Damages	5.9	11.4	13.0	16.4
Total Social Benefits	194.8	349.2	394.9	490.6
Net Social Benefits	29.5	25.3	28.1	24.0
3% SC-GHG DR, 7% Social DR				
Total Social Costs	96.9	192.9	218.7	279.8
Social Benefits				
Private Benefits	94.5	167.8	189.7	236.3
Non-Climate External Benefits	3.1	5.2	5.7	6.9
Reduced Climate Damages	5.9	11.4	13.0	16.4
Total Social Benefits	103.5	184.3	208.5	259.6
Net Social Benefits	6.6	-8.5	-10.3	-20.2
7% SC-GHG DR, 7% Social DR				
Total Social Costs	96.9	192.9	218.7	279.8
Social Benefits				
Private Benefits	94.5	167.8	189.7	236.3
Non-Climate External Benefits	3.1	5.2	5.7	6.9
Reduced Climate Damages	0.6	1.2	1.3	1.7
Total Social Benefits	98.2	174.1	196.7	244.8
Net Social Benefits	1.3	-18.7	-22.0	-35.0

BILLING CODE 4910-59-C

Subsequently, the court of appeals stayed the lower court's order, allowing NHTSA to return to using Interim Estimates for the SCC (and other SC-GHGs), and discounting them at 3 percent. Using these values (which NHTSA believes are more accurate and appropriate) for all regulatory alternatives appear to be cost-beneficial at both 3 percent and 7 percent discount rates, both under a "model year" accounting approach and more so under a "calendar year" approach. Regardless of the values used, while some regulatory alternatives have higher net benefits than others, NHTSA does not consider this dispositive for determining maximum feasible fuel economy, especially, as here, where the net benefits of the different alternatives do not vary greatly, particularly when compared to the overall benefits

associated with all of the regulatory alternatives. Net benefits are exactly that: Net of costs. Some of the benefits accrue to the public generally while some costs are borne directly by private actors. NHTSA's analysis, and the balancing of the factors, considers costs and benefits from both perspectives. While it is true that cost-benefit analysis, and the point at which net benefits are maximized, is informative regarding the economic practicability of different regulatory alternatives, it is one among many considerations, and an alternative having net costs is not inherently economically impracticable. Further, again, a quantitative cost-benefit analysis can only reflect those costs and benefits that can be monetized or quantified, and therefore generally does not fully capture the statutorily relevant considerations. Moreover, for

purposes of this final rule, if all alternatives are roughly the same in terms of net benefits, it is more likely that no alternative is economically *impracticable* on that basis alone. The 2020 final rule also had net benefits that straddled zero, and the agency made a similar conclusion that when net benefits do not vary greatly among alternatives, they are likely not dispositive for NHTSA's decision-making.⁹⁰⁹

⁹⁰⁸ This table uses SC-GHG values from the 2020 final rule. This value does not reflect global climate damages and is not a robust assessment of damage to the United States. Additionally, monetized values do not include other important unquantified effects, such as certain climate benefits, certain energy security benefits, distributional effects, and certain air quality benefits from the reduction of toxic air pollutants and other emissions, among other things.

⁹⁰⁹ See, e.g., 85 FR 24176 (Apr. 30, 2020).

Additionally, consumer costs and benefits may be even more relevant to economic practicability, given the assumption that regulatory costs are passed on to consumers in the form of higher prices for new vehicles. Even using a MY accounting approach, consumers will still experience net benefits for all regulatory alternatives when considering a 3 percent discount rate, and relatively small net costs when considering a 7 percent discount rate in MY 2029, which resolve to net benefits by MY 2039 (again, for all regulatory alternatives).⁹¹⁰

Sales and employment: On the topic of sales, NADA commented that “. . . just under 41 [percent] of U.S. households can afford to buy a new vehicle in today’s market,”⁹¹¹ and that “more than 90 [percent] of household new light duty vehicle acquisitions involve a credit sale or lease. . . .”⁹¹² NADA stated that lenders for new vehicle purchases do not consider the vehicle’s fuel economy in determining whether to make the loan to a prospective vehicle purchaser, and consider only “the total amount financed,” not the “potential reductions in vehicle operating costs, such as those that may result from lower fuel costs, because they cannot predict actuarially whether such cost reductions will be saved, let alone applied, to a loan or lease.”⁹¹³ Consequently, NADA argued that “. . . NHTSA’s assertion that fuel economy performance improvements will result in operating cost reductions that mitigate or offset, at least partially, the higher up-front costs necessary to buy such performance improvements is unsound.”⁹¹⁴ NADA stated that “It is imperative that NHTSA calculate [price and sales] impacts properly and fully account for how consumers are likely to behave during the MY 2024–2026 timeframe.”⁹¹⁵ NADA and Auto Innovators both argued that NHTSA’s sales impact estimates were insufficiently negative, and that real-life sales impacts would be worse.⁹¹⁶

Related to employment, UAW stated that “[b]alanced efficiency regulations, when combined with policies that support domestic auto production and quality jobs, must be part of a policy approach that ensures the advanced technology vehicles result in family and community sustaining jobs for

American workers.”⁹¹⁷ Several commenters supported more stringent CAFE standards in order to boost employment associated with application of more/higher-level technology. Ceres, for example, stated that “[s]tronger standards would particularly benefit suppliers, who collectively employ 3.5 times more Americans than automakers do,” and that “[g]reater EV production would create strong incentives to build a domestic EV supply chain that can operate at higher volumes, helping to keep jobs in the U.S. as the global industry transitions to cleaner technologies.”⁹¹⁸ MEMA stated that “continu[ing] to emphasize and support multiple technological pathways to meet the targets” will “sustain long-term supplier technological investments,” and thus employment.⁹¹⁹ Environmental Law & Policy Center (ELPC) stated as part of its comments offered at the public hearing that strong fuel economy standards spur adoption of fuel-saving technologies, which involve employment.⁹²⁰

UCS noted potential job increases associated both with additional technology application in response to more stringent standards, and “greater job growth overall” due to “the economywide impact of those fuel savings,” which UCS roughly estimated at “up to 67,100 jobs annually over the 2021–2029 period.”⁹²¹ EDF cited a study by Synapse Energy Economics that projected that “the augural standards would add over 100,000 jobs by 2025 and more than 250,000 jobs by 2035,” stating that “Synapse’s study confirms that saving consumers money at the pump, and allowing them to spend those dollars elsewhere, will lead to net job creation.”

In response, NHTSA’s analysis for this final rule projects that new vehicle sales would decrease very slightly—by 70–163 thousand units annually during 2024–2029—due to our assumption that costs associated with meeting more stringent CAFE standards are passed through to consumers. Because the costs associated with meeting more stringent regulatory alternatives are higher, sales effects are greater for more stringent alternatives, but NHTSA does not believe that they are in any way significant enough to signal economic impracticability. By comparison, year-over-year changes in new light vehicle sales have historically averaged about 1 million units, with Federal standards

playing a role that cannot be discerned against the backdrop of much larger forces. For example, the market lost more than four million units between 2007 and 2008 (due to the Great Recession), but subsequently showed gains of more than a million units in 2010, 2012, 2013, and 2015. More recently, although final CAFE compliance data for the 2020 model year is not yet available, the COVID–19 pandemic appears to have caused a year-over-year contraction that would be the second largest ever recorded, and shortages of parts such as computer chips are currently limiting the market’s ability to increase rapidly, despite demand for new vehicles.

With regard to NADA comments about most new vehicle sales being financed, and financing officers not considering fuel savings as relevant to loan repayment capabilities, as we discuss in TSD Chapter 6.1.1.2, NHTSA expects that financing new vehicle purchases reduces the cost of fuel economy standards to consumers by allowing them to spread them out over time. We thus calculate financing costs, but exclude these from cost and benefit accounting. Moreover, NHTSA returns again to the relatively low average per-vehicle cost increases associated with the regulatory alternatives under consideration. The sales effects we estimate, even with the most stringent regulatory alternatives, are modest. Even with the pandemic and supply chain issues, vehicle sales are still somehow increasing year over year, even according to NADA’s own analysis.⁹²² As mentioned above, NHTSA projects that its new standards will impact sales by only about 0.8 percent during MYs 2024–2029. Thus, again, NHTSA does not believe that sales effects suggest the economic impracticability of any of the regulatory alternatives considered in this final rule. NADA exhorts the agency to “calculate these [price and sales] impacts properly and fully account for how consumers are likely to behave during the MY 2024–2026 timeframe.”⁹²³ NHTSA’s analysis carefully estimates impacts on new vehicle costs, accounting for direct costs, cost learning effects, and the

⁹¹⁰ See Table VI–6 and Table VI–7 above.

⁹¹¹ NADA, at 6.

⁹¹² *Id.*, at 7.

⁹¹³ *Id.*, at 7–8.

⁹¹⁴ *Id.*, at 9.

⁹¹⁵ *Id.*, at 3.

⁹¹⁶ *Id.*, at 12; Auto Innovators, at 130.

⁹¹⁷ UAW, at 4.

⁹¹⁸ Ceres, at 1–2.

⁹¹⁹ MEMA, at 5.

⁹²⁰ ELPC, Public Hearing Comments, at 1.

⁹²¹ UCS, at 10.

⁹²² Patrick Manzi, NADA Chief Economist, “NADA Issues Analysis of 2021 Auto Sales, 2022 Sales Forecast,” Jan. 11, 2022, available at <https://blog.nada.org/2022/01/11/nada-issues-analysis-of-2021-auto-sales-2022-sales-forecast/>. (Accessed: March 15, 2022) Specifically, NADA states that “2021 came to a close with new-light vehicle sales of 14.93 million units, an increase of 3.1 [percent] compared to 2020’s sales volume of 14.47 million units,” and, “Moving into 2022, NADA anticipates new-vehicle sales of 15.4 million units—an increase of 3.4 [percent] from 2021.”

⁹²³ NADA, at 3.

historically observed relationship between increased costs and increased prices. NHTSA's analysis also estimates impacts on the new vehicle market using a sales model that is amply supported by the historical record. Because some key market factors (such as manufacturers' pricing strategies) are proprietary and likely impossible for the agency to predict with confidence, irrefutably "correct" methods to estimate impacts on prices and sales are not available, and will likely never be available.

For employment, while NHTSA estimates some loss in employment associated with the slight sales reductions described above, we estimate gains in employment associated with the new technology that would be required in response to more stringent CAFE standards. On balance, we estimate that the technology effects outweigh the sales effects and lead to employment gains relative to the baseline. Thus, one could argue that more stringent alternatives could be more economically practicable from an employment perspective, although the effects are relatively small.

(c) The Effect of Other Motor Vehicle Standards of the Government on Fuel Economy

"The effect of other motor vehicle standards of the Government on fuel economy" involves analysis of the effects of compliance with emission, safety, noise, or damageability standards on fuel economy capability and thus on average fuel economy. In many past CAFE rulemakings, NHTSA has said that it considers the adverse effects of other motor vehicle standards on fuel economy. It said so because, from the CAFE program's earliest years⁹²⁴ until recently, compliance with these other types of standards has had a negative effect on fuel economy. For example, safety standards that have the effect of increasing vehicle weight thereby lower fuel economy capability, thus decreasing the level of average fuel economy that NHTSA can determine to be feasible. NHTSA has also accounted for Federal Tier 3 and California LEV III criteria pollutant standards within its estimates of technology effectiveness in this rule.⁹²⁵

⁹²⁴ 43 FR 63184, 63188 (Dec. 15, 1977). See also 42 FR 33534, 33537 (Jun. 30, 1977).

⁹²⁵ For most ICE vehicles on the road today, the majority of tailpipe NO_x, NMOG, and CO emissions occur during "cold start," before the three-way catalyst has reached higher exhaust temperatures (e.g., approximately 300°C) at which point it is able to convert (through oxidation and reduction reactions) those emissions into less harmful derivatives. By limiting the amount of those emissions, tailpipe smog standards require the

In other cases, the effect of other motor vehicle standards of the Government on fuel economy may be neutral, or positive. Since the Obama administration, NHTSA has considered the GHG standards set by EPA as "other motor vehicle standards of the Government." In the 2012 final rule, NHTSA stated that "[t]o the extent the GHG standards result in increases in fuel economy, they would do so almost exclusively as a result of inducing manufacturers to install the same types of technologies used by manufacturers in complying with the CAFE standards."⁹²⁶ NHTSA concluded in 2012 that "no further action was needed" because "the agency had already considered EPA's [action] and the harmonization benefits of the National Program in developing its own [action]."⁹²⁷ In the 2020 final rule, NHTSA reinforced that conclusion by explaining that a textual analysis of the statutory language made it clear that EPA's CO₂ standards applicable to light-duty vehicles are literally "other motor vehicle standards of the Government," because they are standards set by a Federal agency that apply to motor vehicles. NHTSA and EPA are obligated by Congress to exercise their own independent judgment in fulfilling their statutory missions, even though both agencies' regulations affect both fuel economy and CO₂ emissions. There are differences between the two agencies' programs that make NHTSA's CAFE standards and EPA's GHG standards not perfectly one-to-one (even besides the fact that EPA regulates other GHGs besides CO₂, EPA's CO₂ standards also differ from NHTSA's in a variety of ways, often because NHTSA is bound by statute to a certain aspect of CAFE regulation). NHTSA endeavors to create standards that meet our statutory obligations, including through considering EPA's standards as other motor vehicle standards of the Government.⁹²⁸ As in 2020, NHTSA has

catalyst to be brought to temperature rapidly, so modern vehicles employ cold start strategies that intentionally release fuel energy into the engine exhaust to heat the catalyst to the right temperature as quickly as possible. The additional fuel that must be used to heat the catalyst is typically referred to as a "cold-start penalty," meaning that the vehicle's fuel economy (over a test cycle) is reduced because the fuel consumed to heat the catalyst did not go toward the goal of moving the vehicle forward. The Autonomie work employed to develop technology effectiveness estimates for this final rule accounts for cold-start penalties, as discussed in the Autonomie model documentation.

⁹²⁶ 77 FR 62624, 62669 (Oct. 15, 2012).

⁹²⁷ *Id.*

⁹²⁸ *Massachusetts v. EPA*, 549 U.S. 497, 532 (2007) ("[T]here is no reason to think that the two agencies cannot both administer their obligations and yet avoid inconsistency.").

continued to do all of these things with this final rule.

NHTSA has also considered and accounted for the impacts of California's ZEV mandate (and its adoption by the Section 177 states), incorporating them into the baseline as other regulatory requirements applicable to automakers during the rulemaking time frame. Based on our analysis, NHTSA does not anticipate that the ZEV mandate will in any way constrain or otherwise alter NHTSA's determination of what levels of CAFE standards are maximum feasible. Section IV.B of this preamble discusses NHTSA's consideration of the state ZEV programs and continued technical difficulties with precisely modeling state GHG standards for the model years subject to this rulemaking, and NHTSA refers readers to that section for more information on the topic. Comments regarding the effect of other motor vehicle standards of the Government mostly addressed harmonization of the CAFE and EPA GHG standards, although some commenters addressed State standards. California Attorney General et al. discussed the statutory and legislative history of the "other motor vehicle standards of the Government" provision at some length. Notably, California Attorney General et al. stated that because the current language of the provision was added in 1994 during a recodification and because Congress expressly stated in so doing that it did not intend that the recodification would substantively change the existing law, therefore "other motor vehicle standards of the Government" meant the same as "other Federal motor vehicle standards" in the original statute.⁹²⁹ The commenters continued that ". . . in the original statute, Congress explicitly defined 'Federal standards' to include California emissions standards that had received an EPA waiver," and concluded that "[b]ecause EPCA specifically included California 209(b) standards as 'Federal standards,' California 209(b) standards are included in 'other Federal motor vehicle standards' in the original section 202(e) and thus 'other motor vehicle standards of the Government' in the present-day section 32902(f)." ⁹³⁰ California Attorney General et al. further commented that "[t]his language directs NHTSA to ask whether manufacturers can comply with other motor vehicle standards and the new CAFE standard

⁹²⁹ California Attorney General et al., Docket No. NHTSA-2021-0053-1499 App. A, at 37, citing Public Law 103-272, 108 Stat. at 1060, 1378 (Jul. 5, 1994).

⁹³⁰ *Id.*, at 40.

at the same time; essentially, a fuel economy level is not the ‘maximum feasible’ if it is achievable only through noncompliance with ‘other motor vehicle standards of the Government.’”⁹³¹ The commenters thus agreed with including state ZEV standards in the CAFE baseline, because doing so is “consistent with Congress’ direction that any compliance pathway modeled for proposed fuel economy standards continues to comply with California 209(b) standards as well.”⁹³² NCAT agreed that EPA’s GHG emissions standards for light-duty vehicles, along with ZEV mandates for which a waiver has been granted under CAA 209(b), are clearly “‘other motor vehicle standards of the Government’ that NHTSA properly considers . . . , including by modifying NHTSA’s CAFE Model to account for them.”⁹³³ NCAT argued further that “[t]here is no statutory conflict between the statutory requirement not to consider the ‘fuel economy’ of alternative fuel vehicles and the statutory requirement to consider ‘other motor vehicle standards of the Government’ such as ZEV mandates,” because “ZEV (zero emission vehicle) mandates are vehicle emissions standards *not related* to fuel economy because they do not regulate ‘fuel’ or ‘fuel economy’ as those terms are defined under EPCA, they cannot be met through more efficient use of ‘fuel,’ and they are enacted for reasons unrelated to fuel economy.”⁹³⁴

Lucid commented that NHTSA should “further explain that California’s ZEV mandate is crucial to achieving the stated goals of EPCA, EISA, and the CAFE regulations, and that the CAFE standards put in place by the rulemaking are designed to work cooperatively with these ZEV standards.”⁹³⁵ AFPM, in contrast, commented that EPCA preempts ZEV and California’s GHG standards, and that therefore those standards are invalid regardless of whether a waiver of CAA preemption is granted by EPA.⁹³⁶

In response, with regard to Lucid’s and AFPM’s comment, NHTSA’s substantive position on ZEV mandates has not changed since the CAFE Preemption final rule withdrawing the SAFE 1 rule that NHTSA published in the **Federal Register** on December 29, 2021,⁹³⁷ and NHTSA is not offering a

new interpretation of the scope of EPCA preemption in this rule. As the CAFE Preemption final rule makes clear, NHTSA is not taking a position on whether or not those programs are preempted under EPCA, nor does NHTSA even have authority to make such determinations with the force of law. Further, NHTSA has not incorporated the California and 177 ZEV mandate in the baseline based on a determination that they are other motor vehicle standards of the Government. Rather, as explained above, NHTSA has incorporated those standards in the baseline because they are legal obligations applying to automakers during the rulemaking time frame, and are therefore relevant to understanding the state of the world absent any further regulatory action by NHTSA. With regard to the comment from California Attorney General et al., NHTSA appreciates the commenters’ close reading of the statutory and legislative history. However, this is not a situation where consideration of the California ZEV standards and their adoption by 177 states would change NHTSA’s analysis or determination of maximum feasible standards, as discussed above. It is therefore unnecessary for NHTSA to decide whether these standards are other motor vehicle standards of the Government, and as such, NHTSA is not making that determination.⁹³⁸

A number of commenters addressed the question of harmonization between the NHTSA CAFE standards and other standards, which NHTSA believes is relevant to consideration of “other motor vehicle standards of the Government” insofar as commenters generally asked NHTSA to set CAFE standards taking into consideration automakers’ simultaneous compliance with those other motor vehicle standards. Nissan, MECA, Stellantis, GM, Peter Douglas, and BorgWarner all requested that NHTSA harmonize the CAFE standards with the EPA GHG standards and CARB’s GHG and ZEV standards.⁹³⁹ Stellantis stated that a lack of harmonization between these programs adds “significant complexity

⁹³⁸ NHTSA notes that many commenters offered views as to the inclusion of California and 177 standards in the baseline and harmonization of CAFE and California and 177 standards in the context of discussing other motor vehicle standards of the Government. The fact that NHTSA is responding to these comments in the context in which they were raised does not alter the fact that NHTSA is not making a determination as to whether these standards are other motor vehicle standards of the Government.

⁹³⁹ Nissan, Docket No. NHTSA–2021–0053–0022, at 2, 6; MECA, at 1; Stellantis, at 2; GM, at 3; Peter Douglas, at 6, BorgWarner, Docket No. NHTSA–2021–0053–1473, at 2.

to compliance and adds unnecessary costs to a resource-intensive transition to electric vehicles.”⁹⁴⁰ Ingevity Corporation did not address CARB standards but requested harmonization between the EPA GHG standards, the NHTSA CAFE standards, and DOE research targets.⁹⁴¹

Commenters also addressed the specific question of harmonization between NHTSA CAFE and EPA GHG standards, mostly in the context of stringency. Ford, JLR, MEMA, and Arconic all commented that NHTSA’s MY 2026 CAFE standards should be aligned with EPA’s MY 2026 GHG standards.⁹⁴² Several commenters requested that NHTSA account more fully for EPA programmatic flexibilities when determining CAFE stringency, suggesting that CAFE and GHG standards are not harmonized unless CAFE stringency requires no additional effort by automakers beyond what GHG compliance, with its more extensive flexibilities, would require. For example, in their comments at the public hearing, Auto Innovators stated that “[i]n harmonizing NHTSA actions with EPA actions, NHTSA should account for the differences in the treatment of electric vehicles under the EPA and NHTSA programs. Final NHTSA CAFE and EPA GHG standard should be aligned in stringency such that the CAFE program does not drive additional improvements beyond those required under the GHG program, nor make EPA incentives for higher EV production moot.”⁹⁴³

In their written comments, Auto Innovators expanded on this request, “. . . recommend[ing] that, at minimum, the differences caused by direct AC emissions credits, EV compliance calculation differences, and EV multipliers be accounted for when final CAFE and GHG standards are set for MYs 2025–2026.”⁹⁴⁴ Other cited differences included “statutory limitations for credit transfers, the split of the passenger car fleet into import and domestic fleets, and minimum domestic passenger car standards create additional unquantified stringency in the CAFE program relative to the GHG program,”⁹⁴⁵ as well as the fact that CAFE regulations do not adjust credit value when credits are carried forward and back, and that NHTSA is bound by

⁹⁴⁰ Stellantis, at 2.

⁹⁴¹ Ingevity Corporation, Docket No. NHTSA–2021–0053–0092, at 5.

⁹⁴² Ford, at 1; JLR, Docket No. NHTSA–2021–0053–1505, at 3; MEMA, at 3; Arconic, Docket No. NHTSA–2021–0053–1560, at 2.

⁹⁴³ Auto Innovators Hearing Comments, at 3.

⁹⁴⁴ *Id.*, at 37.

⁹⁴⁵ *Id.*, at 13.

⁹³¹ *Id.*

⁹³² *Id.*

⁹³³ NCAT, at 6.

⁹³⁴ *Id.*

⁹³⁵ Lucid, at 5.

⁹³⁶ AFPM, at 11–13.

⁹³⁷ 86 FR 74236 (Dec. 29, 2021).

statute on credit carry-forward duration while EPA is not.⁹⁴⁶ Stellantis and Toyota offered similar comments.⁹⁴⁷ Ford, Stellantis, and Auto Innovators also specifically requested an explicit offset between the CAFE standards and the GHG standards to account for direct AC credits that automakers expect to use toward compliance with the GHG standards.⁹⁴⁸ Auto Innovators further commented that NHTSA's estimate of the specific amount of direct AC leakage credit that industry would use in the EPA program might be too low, given passage of the American Innovation and Manufacturing (AIM) Act, EPA regulations implementing it, and CARB's stated intent to eliminate high-GWP refrigerants sooner rather than later⁹⁴⁹—effectively, that manufacturers will be leaning heavily on direct AC leakage credits as part of their GHG standards compliance.

Other commenters requesting that NHTSA harmonize CAFE stringency with EPA GHG effective stringency in light of EPA programmatic flexibilities included UAW, Nissan, AVE, Mercedes-Benz, Hyundai America Technical Center, Inc. (Hyundai), Volkswagen, and others.⁹⁵⁰ EDF commented that CAFE and GHG standard stringency and flexibilities should be harmonized, but by reducing available flexibilities rather than by dropping stringency to account for them.⁹⁵¹

Some commenters noted that even if stringencies are aligned, one program may be more stringent in a given year for a specific manufacturer than the other. Honda stated that “[e]ven if GHG and CAFE topline stringencies were fully aligned, it would not be uncommon for manufacturers to find themselves compliant in one agency program, while facing meaningful compliance challenges in another.”⁹⁵² Auto Innovators commented similarly.⁹⁵³ Toyota stated that “. . . the CAFE program ‘appears’ less stringent than the GHG program for 2024 MY, particularly for light trucks, but the stringency gap shrinks when credit transfer limitations and other

harmonization factors not being analyzed here are considered.”⁹⁵⁴

Some commenters argued that NHTSA must analyze both CAFE standards and GHG standards simultaneously to ensure that the CAFE standards are fully harmonized with the GHG standards. Auto Innovators stated that “[d]eveloping . . . harmonized regulations requires the Agencies to fully assess their policies in the context of the other’s proposal (especially since there is not a unified rulemaking over the covered period due to lead-time constraints).”⁹⁵⁵ Toyota commented similarly that NHTSA must analyze both programs simultaneously and then drop its stringency below the proposal, because “[a]ttaining single fleet compliance with both programs by forcing manufacturers to design for the most stringent elements of both programs does not achieve [the ‘One National Program’] objective consistent with past practice.”⁹⁵⁶ Rivian and Securing America’s Future Energy agreed that NHTSA should analyze both programs simultaneously, but argued that NHTSA should do so because the CAFE proposal was less stringent than the GHG proposal, and that therefore NHTSA should raise CAFE stringency in the final rule.⁹⁵⁷

Some commenters also argued that NHTSA should adopt a “deemed-to-comply” provision, such that manufacturers need only comply with EPA GHG standards and NHTSA would accept that compliance in lieu of actual compliance with CAFE standards.⁹⁵⁸ GM commented as follows:

NHTSA has the statutory authority to adopt a deemed-to-comply provision as it considers “the effect of other motor vehicle standards of the Government”—including EPA’s GHG standards—in determining [maximum feasible CAFE standards]. NHTSA’s consideration of “economic practicability” and “technological feasibility” should include the economic and technical challenges that EV-focused manufacturers will face from attempting to comply with separate but overlapping NHTSA, EPA, and California regulatory regimes. The statute thus permits—and arguably requires—that NHTSA consider how it can best coordinate its CAFE standards with EPA’s GHG standards and the nation’s Paris Agreement commitments, including (where appropriate) by deeming compliance with EPA’s GHG standards to be sufficient to constitute compliance with

NHTSA’s CAFE standards. This approach is also consistent with the Supreme Court’s assumption that “the two agencies can both administer their obligations and avoid inconsistency.”⁹⁵⁹

Volvo Cars (Volvo) commented that NHTSA, EPA, and CARB should work together to “reduce reporting requirements by allowing manufacturers to demonstrate compliance at the end of the year for all programs.”⁹⁶⁰

Other commenters simply encouraged NHTSA and EPA to go back to working together to issue joint rules,⁹⁶¹ while some commenters argued there was no need for unified proposals or final rules.⁹⁶² The environmental group commenters “. . . urge[d] NHTSA to finalize its rulemaking as soon as possible, and certainly before April 2022,” stating that “[c]ommenters recognize that given the agencies’ current pace, EPA may finalize its revised LDV GHG emissions standards before NHTSA finalizes this rulemaking. This serial approach is acceptable as nothing compels the agencies to proceed in tandem.”⁹⁶³ Consumer Federation of America, in contrast, commented that NHTSA should cede its decision-making authority to EPA entirely, stating that “. . . NHTSA’s approach is so favorable to a small number of automakers that we think Congress should . . . either remove the standard setting function from NHTSA altogether, or it should make NHTSA’s analysis merely advisory to EPA, who would be charged with setting the standard.”⁹⁶⁴

In response, NHTSA has carefully considered EPA’s standards, by including the baseline (*i.e.*, 2020) CO₂ standards in our analytical baseline for the main analysis. Because the EPA and NHTSA programs were developed in coordination jointly, and stringency decisions were made in coordination, NHTSA did not incorporate EPA’s only-recently-finalized CO₂ standards as part of the analytical baseline for the main analysis. The fact that EPA finalized its rule before NHTSA is an artifact of circumstance only. However, in response to comments, NHTSA has also

⁹⁴⁶ *Id.*, at 33.

⁹⁴⁷ Stellantis, at 9–10; Toyota, Docket No. NHTSA–2021–0053–1568, at 2–3.

⁹⁴⁸ Ford, at 1; Stellantis, at 8; Auto Innovators, at 32.

⁹⁴⁹ Auto Innovators, at 37 n.60.

⁹⁵⁰ UAW, at 2, 6; Nissan, at 2; AVE, Docket No. NHTSA–2021–0053–1488–A1, at 3; Mercedes-Benz, Docket No. NHTSA–2021–0053–0952, at 3; Hyundai, Docket No. NHTSA–2021–0053–1512, at 5; Volkswagen, Docket No. NHTSA–2021–0053–1548, at 3.

⁹⁵¹ EDF, at 1.

⁹⁵² Honda, Docket No. NHTSA–2021–0053–1501, at 5.

⁹⁵³ Auto Innovators, at 31.

⁹⁵⁴ Toyota, Docket No. NHTSA–2021–0053–1568, at 2.

⁹⁵⁵ Auto Innovators, at 30.

⁹⁵⁶ Toyota, at 4.

⁹⁵⁷ Rivian, Docket No. NHTSA–2021–0053–1562, at 4–5; Securing America’s Future Energy, at 8.

⁹⁵⁸ *See, e.g.*, Auto Innovators, at 13, 30–31; Stellantis, at 8.

⁹⁵⁹ GM, Docket No. NHTSA–2021–0053–1523, at 6–7. NHTSA disagrees that Paris Agreement commitments are properly considered as “other motor vehicle standards of the Government,” even if they are broadly relevant to energy conservation goals, including those of the CAFE program.

⁹⁶⁰ Volvo, Docket No. NHTSA–2021–0053–1565, at 3.

⁹⁶¹ WDNR, Docket No. NHTSA–2021–0053–0059, at 4; NADA, at 4.

⁹⁶² CBD et al., Docket No. NHTSA–2021–0053–1572, at 7; Great Lakes and Midwest Environmental Organizations, Docket No. NHTSA–2021–0053–1520, at 2; NCAT, at 4.

⁹⁶³ CBD et al., at 7.

⁹⁶⁴ CFA, Docket No. NHTSA–2021–0053–1482, Appendix A1, at 3.

conducted a side analysis in which we analyzed simultaneous compliance with EPA's recently finalized CO₂ standards and the regulatory alternatives considered here. This analysis confirms that complying with the EPA and NHTSA standards simultaneously is feasible.

Unlike the reference case analysis and sensitivity analysis cases discussed elsewhere in this document and FRIA, this side analysis applies the modeling approach used for the Final SEIS; that is, without setting aside additional BEV models or the use of compliance credits

during the model years for which the agency is issuing new CAFE standards. The agency conducted this side analysis in this way because NHTSA expects that the approach followed for the Final SEIS provides the most realistic and internally consistent basis to account for interactions between the CAFE and CO₂ standards. Considering industry-wide MY 2029 results summarized in the following table, new CAFE standards clearly lead to a more pronounced shift away from conventional gasoline powertrains—and toward SHEVs, PHEVs, and BEVs—when combined

with new CO₂ standards than when combined with baseline CO₂ standards (*i.e.*, those established in the 2020 final rule), but not a shift that is faster than indicated by many manufacturers' announced electrification plans. Additional costs (beyond continued reliance on MY 2020 technology) in MY 2029 under new CAFE standards are also somewhat higher (by about \$700) when new CO₂ standards are also in effect, but only slightly higher (by about \$125) than when baseline CAFE standards are continued alongside new CO₂ standards.

Table VI-8 – MY 2029 Average Per-Vehicle Costs (2018 \$ vs. MY 2020 Technology) and SHEV/PHEV/BEV Adoption

	Alt. 0 CAFE		Alt. 1 CAFE		Alt. 2 CAFE		Alt. 2.5 CAFE		Alt. 3 CAFE	
	Base CO ₂	Final CO ₂	Base CO ₂	Final CO ₂	Base CO ₂	Final CO ₂	Base CO ₂	Final CO ₂	Base CO ₂	Final CO ₂
Technology	1,024	2,607	1,374	2,620	1,769	2,677	1,944	2,733	2,206	2,787
CAFE Fines	-	-	27	-	62	-	79	-	92	-
Total	1,024	2,607	1,401	2,620	1,831	2,677	2,024	2,733	2,298	2,787
SHEVs	5.9%	19.1%	9.0%	19.8%	12.1%	19.1%	13.3%	19.4%	16.6%	21.1%
PHEVs	0.2%	2.1%	0.3%	2.3%	0.3%	2.4%	0.3%	2.2%	0.3%	2.5%
BEVs	5.7%	12.6%	6.8%	12.6%	9.3%	12.9%	10.3%	13.1%	11.9%	13.1%

These results do not, however, demonstrate that new CO₂ standards somehow hinder compliance with new CAFE standards. Rather, for some manufacturers, especially those that could be expected to continue to avail themselves of EPCA's civil penalty provisions, new CO₂ standards are likely to be binding, because paying fines for a failure to comply with CO₂ standards is not a viable option for a manufacturer wishing to sell vehicles in the U.S. This is why, in every case shown above, the presence of new CO₂ standards leads all manufacturers to achieve MY 2029 CAFE levels that no longer necessitate payment of civil penalties. On the other hand, even with new CO₂ standards, new CAFE standards could be binding for some manufacturers in some model years, because in EPCA/EISA, Congress expressly required, *inter alia*, that manufacturers meet minimum standards for domestic cars, that NHTSA limit transfers of CAFE compliance credits between regulated fleets, and that the fuel economy ratings of electric vehicles be determined using a petroleum equivalency factor established by DOE

for EVs based on specified factors.⁹⁶⁵ Overall, these results suggest that new CO₂ standards will likely interact with new CAFE standards in a manner that leads to more widespread industry compliance with new CAFE standards, leading NHTSA to conclude that new CO₂ standards do not constrain the maximum feasible levels of new CAFE standards.

NHTSA is aware that when multiple agencies regulate concurrently in the same general space, different regulations may be binding for different regulated entities at different times. NHTSA agrees that in the 2012 rule, NHTSA and EPA included in our respective stringencies an express offset for an assumed amount of direct AC credit and reliance on EPA incentives for PHEVs EVs, and FCEVs that the agencies believed, at the time, manufacturers would employ in meeting the EPA standards, and for which NHTSA could not give credit toward CAFE compliance.⁹⁶⁶ At the time, the agencies stated that:

We note, however, that the alignment is based on the assumption that manufacturers

implement the same level of direct A/C system improvements as EPA currently forecasts for those model years, and on the assumption of PHEV, EV, and FC[E]V penetration at specific levels. If a manufacturer implements a higher level of direct A/C improvement technology (although EPA predicts 100 [percent] of manufacturers will use substitute refrigerants by MY 2021, and the GHG standards assume this rate of substitution) and/or a higher penetration of PHEVs, EVs, and FC[E]Vs, then NHTSA's standards would effectively be more stringent than EPA's. Conversely, if a manufacturer implements a lower level of direct A/C improvement technology and/or a lower penetration of PHEVs, EVs and FC[E]Vs, then EPA's proposed [*sic*] standards would effectively be more stringent than NHTSA's. Several manufacturers commented on this point and suggested that this meant that the standards were not aligned, because NHTSA's standards might be more stringent in some years than EPA's. This reflects a misunderstanding of the agencies' purpose. The agencies have sought to craft harmonized standards such that manufacturers may build a single fleet of vehicles to meet both agencies' requirements. That is the case for these final standards. *Manufacturers will have to plan their compliance strategies considering both the NHTSA standards and the EPA standards and assure that they are in compliance with both, but they can still*

⁹⁶⁵ See 49 U.S.C. 32904(a)(2)(B).

⁹⁶⁶ See 77 FR 63054 (Oct. 15, 2012).

build a single fleet of vehicles to accomplish that goal.⁹⁶⁷ (emphasis added)

Even in 2012, the agencies anticipated the possibility of this situation and explained that regardless of which agency's standards are binding given a manufacturer's chosen compliance path, manufacturers will still have to choose a path that complies with both standards, and in doing so, will still be able to build a single fleet of vehicles—even if it is not exactly the fleet that the manufacturer might have preferred to build. This remains the case today.

In requesting that NHTSA account precisely for each difference between the programs and calculate the CAFE standard accordingly, commenters appear to be asking NHTSA to define “maximum feasible” as “the fuel economy level at which no manufacturer need ever apply any additional technology or spend any additional dollar beyond what EPA's standards, with their greater flexibilities, would require.” NHTSA believes that this takes “consideration” of “the effect of other motor vehicle standards of the Government” farther than Congress intended for it to go. NHTSA has considered EPA's standards in determining the maximum feasible CAFE standards for MYs 2024–2026, as demonstrated above and throughout the analysis that informs this decision. NHTSA has also harmonized its standards with EPA's where doing so was consistent with NHTSA's separate statutory direction. NHTSA disagrees that harmonization can only be achieved at the very cheapest level, or that this would be consistent with NHTSA's statutory mandate, even though NHTSA understands that for-profit companies would rather spend less money meeting regulations than more money, and that automakers have committed to major technological improvements to their fleets in the coming years. With regard to GM's comment about “the economic and technical challenges that EV-focused manufacturers will face from attempting to comply with separate but overlapping NHTSA, EPA, and California regulatory regimes,” NHTSA notes that GM, among others, has argued that NHTSA may not consider electrification in standard setting, but also notes that these challenges are likely to be transitory, albeit genuine during the time frame of this rulemaking, and NHTSA does provide compliance credits for electric vehicles. Automakers who build only electric vehicles clearly have no difficulty complying with NHTSA's

CAFE standards or EPA's and CARB's GHG emissions (and ZEV) standards. Moreover, those technological improvements that companies like GM are making will, no doubt, facilitate their compliance with CAFE standards, even if they are not credited as heavily as in the GHG program.

NHTSA believes that automaker comments about “building a single fleet of vehicles” and Toyota's comment about “forcing manufacturers to design for the most stringent elements of both programs” have ignored the agencies' discussion from 2012 excerpted above, but also miss the broader point that NHTSA must set maximum feasible CAFE standards. Manufacturers can absolutely continue to build a single fleet of vehicles to meet all applicable standards, even if the CAFE standards may ultimately require some technology application on at least some vehicles that the GHG standards, with their flexibilities, may not require. This outcome is not inconsistent with NHTSA's statutory obligation to set maximum feasible standards that conserve energy.

Additionally, harmonization can be considered and achieved regardless of whether NHTSA and EPA (or NHTSA and EPA and CARB) take perfectly joint, concurrent action. NHTSA agrees with the commenters who noted that there is no express legal requirement for CAFE rulemaking actions to be joint or concurrent with other agencies' actions.

With regard to the comments encouraging NHTSA to accept compliance with EPA (or CARB) standards in lieu of compliance with CAFE standards, and the comment urging NHTSA to cede its decision-making authority to EPA, NHTSA does not believe that doing either would be consistent with the intent of “the effect of other motor vehicle standards of the Government on fuel economy” provision. Congress would not have set that provision as one factor among four for NHTSA to consider if it intended for it to control absolutely—instead, NHTSA and courts have long held that all factors must be considered together. Moreover, Congress delegated to DOT (and DOT delegated to NHTSA) decision-making authority for the CAFE standards program. The Supreme Court said in *Massachusetts v. EPA* that because “DOT sets mileage standards in no way licenses EPA to shirk its environmental responsibilities. EPA has been charged with protecting the public's ‘health’ and ‘welfare,’ 42 U.S.C. 7521(a)(1), a statutory obligation wholly independent of DOT's mandate to promote energy efficiency. See Energy Policy and Conservation Act, § 2(5), 89

Stat. 874, 42 U.S.C. 6201(5). The two obligations may overlap, but there is no reason to think the two agencies cannot both administer their obligations and yet avoid inconsistency.” The converse must necessarily be true—the fact that EPA sets GHG standards in no way licenses NHTSA to shirk its energy conservation responsibilities. Unless and until Congress changes EPCA/EISA, NHTSA is bound to continue exercising its own independent judgment and setting CAFE standards and to do so consistent with statutory directives. Part of setting CAFE standards is considering EPA's GHG standards and other motor vehicle standards of the Government and how those affect manufacturers' ability to comply with potential future CAFE standards, but that is only one inquiry among several in determining what levels of CAFE standards would be maximum feasible.

Additionally, nothing in EPCA or EISA suggests that compliance with GHG or State emissions standards would be an acceptable basis for CAFE compliance. The calculation provisions in 49 U.S.C. 32904 are explicit. The compliance provisions in 49 U.S.C. 32912 state that automakers must comply with applicable *fuel economy standards*, and failure to do so is a failure to comply. Federal emissions standards and State emissions standards are not fuel economy standards. NHTSA does not agree that a “deemed to comply” option is consistent with the statute, nor that it is necessary for coordination with and consideration of those other standards.

(d) The Need of the U.S. to Conserve Energy

NHTSA has consistently interpreted “the need of the United States to conserve energy” to mean “the consumer cost, national balance of payments, environmental, and foreign policy implications of our need for large quantities of petroleum, especially imported petroleum.”⁹⁶⁸ A number of commenters addressed different aspects of the need of the United States to conserve energy, as discussed below.

(1) Consumer Costs and Fuel Prices

Fuel for vehicles costs money for vehicle owners and operators, so all else equal, consumers benefit from vehicles that need less fuel to perform the same amount of work. Future fuel prices are a critical input into the economic analysis of potential CAFE standards because they determine the value of fuel savings both to new vehicle buyers and to society; the amount of fuel economy

⁹⁶⁷ *Id.* at 63054–63055.

⁹⁶⁸ 42 FR 63184, 63188 (Dec. 15, 1977).

that the new vehicle market is likely to demand in the absence of regulatory action; and they inform NHTSA about the “consumer cost . . . of our need for large quantities of petroleum.” For this final rule, NHTSA relied on fuel price projections from the U.S. Energy Information Administration’s (EIA) Annual Energy Outlook (AEO) for 2021. Federal Government agencies generally use EIA’s price projections in their assessment of future energy-related policies.

In previous CAFE rulemakings, discussions of fuel prices have always been intended to reflect the price of motor gasoline. However, a growing set of vehicle offerings that rely in part, or entirely, on electricity suggests that gasoline prices are no longer the only fuel prices relevant to evaluations of the effects of different possible CAFE standards. In the analysis supporting this final rule, NHTSA considers the energy consumption and resulting emissions from the entire on-road fleet, which already contains a number of plug-in hybrid and fully electric vehicles. Higher CAFE standards encourage manufacturers to improve fuel economy; concurrently, manufacturers will foreseeably seek to continue to maximize profit (or minimize compliance cost), and some reliance on electrification is a viable strategy for some manufacturers, even though NHTSA does not consider it in determining maximum feasible CAFE stringency. Under the more stringent CAFE alternatives considered for this final rule, we see a greater reliance on electrification technologies in the analysis in the years following the explicitly regulated model years, even though internal combustion engines continue to be the most common powertrain across the industry in the action years of this rulemaking.

While the current national average electricity price is significantly higher than that of gasoline, on an energy equivalent basis (\$/MMBtu),⁹⁶⁹ electric motors convert energy into propulsion much more efficiently than internal combustion engines. This means that, even though the energy-equivalent prices of electricity are higher, electric vehicles still produce fuel savings for their owners. EIA’s AEO 2021 also projects rising real gasoline prices over the next three decades, while projecting real electricity prices to remain relatively flat. As the reliance on electricity grows in the light-duty fleet, NHTSA will continue to monitor the trends in electricity prices and their implications for CAFE standards. Even

if NHTSA is prohibited from considering electrification as a technology during the model years covered by the rulemaking, the consumer (and social) cost implications of manufacturers otherwise switching to electrification may remain relevant to the agency’s considerations.

For now, gasoline is still the dominant fuel used in light-duty transportation. As such, consumers, and the economy more broadly, are subject to fluctuations in price that impact the cost of travel and, consequently, the demand for mobility. Over the last decade, the U.S. has become a stabilizing force in the global oil market and our reliance on imported petroleum has decreased steadily. AEO 2021 projects the U.S. to be a net exporter of petroleum and other liquids through 2050 in the Reference Case. Over the last decade, EIA projections of real fuel prices have generally flattened in recognition of the changing dynamics of the oil market and slower demand growth, both in the U.S. and in developing markets. For example, the International Energy Agency has projected that global demand for gasoline is unlikely to ever return to its 2019 level (before the pandemic).⁹⁷⁰ However, vehicles are long-lived assets, and the long-term price uncertainty of petroleum still represents a risk to consumers, albeit one that has decreased in the last decade. Continuing to reduce the amount of money consumers spend on vehicle fuel thus remains an important consideration for the need of the U.S. to conserve energy.

Comments received on the consumer cost aspect of the need of the U.S. to conserve energy were divided between comments relating to future electrification, and comments about equity. For the former, Kia commented that “fluctuations in the cost for fueling EVs should also play into the analysis of potential alternatives,” given that NHTSA noted in the preamble that fluctuations in fuel prices affect the cost of travel and thus mobility demand.⁹⁷¹ NHTSA does account for this by using electricity prices from AEO 2021 in our analysis, as described above.

AFPM argued that because a recent NBER “study finds that EVs are driven just 5,300 miles per year, less than half the average internal combustion engine vehicle,” therefore “[t]his single omission results in the [a]gency arbitrarily doubling any estimated

avoided emissions and fuel savings.”⁹⁷² This suggests that consumer fuel savings associated with increased electrification may be overstated. In response, while NHTSA has examined the possibility of different VMT schedules for BEVs, we have not yet implemented them in our analysis. However, at this time and for this rulemaking, we do not believe that different VMT schedules would be significant. Electric miles represent 2.5 percent of total miles (over the lifetimes of vehicles considered in this analysis) in the baseline, which rises to only 3.4 percent under the Preferred Alternative. Penetration rates of BEVs remain quite low through MY 2029. Thus, the additional benefits estimated as a result of electrification remain an extremely small portion of overall benefits, and are not dispositive for NHTSA’s decision in this document.

On the topic of equity, California Attorney General et al. argued that “. . . decreasing domestic demand for petroleum would decrease domestic income inequality by reducing oil prices,” because “[h]igher gasoline prices result in significant costs for families in the United States,” and the “transfer of revenue from U.S. oil producers to U.S. oil consumers could have substantial benefits for the most economically disadvantaged, reducing income inequality. . . .”⁹⁷³ ELPC also commented at the public hearing that strong fuel economy standards will increase equity by saving American consumers money.⁹⁷⁴

Environmental Law & Policy Center with 15 Great Lakes and Midwest Partners (Great Lakes and Midwest Environmental Organizations) commented that “[f]uel-efficient cars save vehicle owners money at the gas pump and are especially important for low-income Americans, who spend a greater proportion of their income on gasoline. Assuring that new cars sold today are as efficient as possible means that fuel-efficient used cars will be available in a few years.”⁹⁷⁵ EDF similarly commented that raising CAFE standards will “give consumers more flexibility when oil prices increase. And it will increasingly benefit low-income families as many of the lowest-income U.S. households spend nearly one-fifth of their income on gasoline—three times more than the average U.S. household.”⁹⁷⁶ ACEEE offered nearly

⁹⁷² AFPM, at 18.

⁹⁷³ California Attorney General et al., Docket No. NHTSA–2021–0053–1499, Appendix A, at 6.

⁹⁷⁴ ELPC public hearing comments, at 2.

⁹⁷⁵ Great Lakes and Midwest Environmental Organizations, at 3.

⁹⁷⁶ EDF, at 7.

⁹⁷⁰ International Energy Agency, Oil 2021, (p. 30), https://iea.blob.core.windows.net/assets/1fa45234-bac5-4d89-a532-768960f99d07/Oil_2021-PDF.pdf. (Accessed: March 15, 2022)

⁹⁷¹ Kia, at 7.

⁹⁶⁹ Source: AEO 2021, Table 3.

identical comments about the burden of gasoline purchases on low-income families, adding that “[f]ueling costs can be a major household expense and can inhibit families from accessing jobs, educational opportunities, and essential services.”⁹⁷⁷ Consumer Reports offered similar comments at the public hearing, stating that “Lower income households spend a higher percentage of their income on energy. This energy burden could be alleviated by having more fuel-efficient vehicles available on the market.”⁹⁷⁸

NHTSA agrees with commenters that raising fuel economy standards can reduce consumer costs on fuel—this has long been a major focus of the CAFE program, and was one of the driving considerations for Congress in establishing the CAFE program originally. Over time, as average VMT has increased and more and more Americans have come to live farther and farther from their workplaces and activities, fuel costs have become even more important. Even when gasoline prices, for example, are relatively low, they can still add up quickly for consumers whose daily commute measures in hours, like many Americans in economically disadvantaged and historically underserved communities. When vehicles can go farther on a gallon of gas, lower income consumers save money, and as commenters note, that money may represent a larger percentage of their income and overall expenditures than for more-advantaged consumers. Of course, when fuel prices spike, low income consumers suffer disproportionately. Thus, clearly, the need of the United States to conserve energy is well-served by helping consumers save money at the gas pump.

NHTSA and the Department of Transportation are committed to improving equity in transportation. Helping economically disadvantaged and historically underserved Americans save money on fuel and get where they need to go is an important piece of this puzzle, and it also improves energy conservation, thus implementing Congress’ intent in EPCA. All of the action alternatives considered in this final rule improve fuel economy as compared to the baseline standards, with the most stringent alternatives saving consumers the most on fuel costs. As in the proposal, then, the most stringent alternatives likely best serve the need of the United States to conserve energy in this respect.

⁹⁷⁷ ACEEE, at 1 (citation omitted).

⁹⁷⁸ Consumer Reports public hearing comments, at 1.

(2) National Balance of Payments

NHTSA has consistently included consideration of the “national balance of payments” as part of the need of the U.S. to conserve energy because of concerns that importing large amounts of oil created a significant wealth transfer to oil-exporting countries and left the U.S. economically vulnerable.⁹⁷⁹ As recently as 2009, nearly half the U.S. trade deficit was driven by petroleum,⁹⁸⁰ yet this concern has been less critical in more recent CAFE actions, in part because other factors besides petroleum consumption have been playing a bigger role in the U.S. trade deficit.⁹⁸¹ While transportation demand is expected to increase as the economy recovers from the pandemic, it is foreseeable that the trend of trade in consumer goods and services continuing to dominate the national balance of payments, as compared to petroleum, will continue during the rulemaking time frame.

California Attorney General et al. agreed with NHTSA that the national balance of payments was still a relevant consideration for the need of the United States to conserve energy. They stated, however, that “. . . NHTSA could improve its analysis by noting that even as a net exporter last year, the United States is still not self-sufficient in petroleum production. Rather, the United States’ domestic gross crude oil imports are expected to remain between 6.9 and 7.8 million metric barrels per day through 2050 without the proposed CAFE standard revision. [citing AEO 2021, Table D.1] Incremental reduction

⁹⁷⁹ For the earliest discussion of this topic, see 42 FR 63184, 63192 (Dec. 15, 1977) (“A major reason for this need [to reduce petroleum consumption] is that the importation of large quantities of petroleum creates serious balance of payments and foreign policy problems. The United States currently spends approximately \$45 billion annually for imported petroleum. But for this large expenditure, the current large U.S. trade deficit would be a surplus.”).

⁹⁸⁰ See, *Today in Energy: Recent improvements in petroleum trade balance mitigate U.S. trade deficit*, U.S. Energy Information Administration (July 21, 2014). Available at <https://www.eia.gov/todayinenergy/detail.php?id=17191> (accessed: March 15, 2022) and in the docket for this rulemaking, NHTSA–2021–0053.

⁹⁸¹ Consumer products are the primary drivers of the trade deficit. In 2020, the U.S. imported \$2.4 trillion in consumer goods, versus \$116.4 billion of petroleum, which is the lowest amount since 2002. The 2020 goods deficit of \$904.9 billion was the highest on record, while the 2020 petroleum surplus of \$18.1 billion was the first annual surplus on record. See U.S. Census Bureau, “Annual 2020 Press Highlights,” at [census.gov/foreign-trade/statistics/highlights/AnnualPressHighlights.pdf](https://www.census.gov/foreign-trade/statistics/highlights/AnnualPressHighlights.pdf), (accessed: March 15, 2022) and available in the docket for this rulemaking. While 2020 was an unusual year for U.S. transportation demand, given the global pandemic, this is consistent with existing trends in which consumer products imports significantly outweigh oil imports.

in expenditures on foreign oil would thus serve to improve the national balance of payments and fulfill the statutory purpose.”⁹⁸²

Whether or not overall reductions in oil consumption lead to reductions in oil imports specifically, NHTSA agrees that the U.S. does continue to rely on oil imports, and NHTSA continues to recognize that reducing the vulnerability of the U.S. to possible oil price shocks remains important. This final rule aims to improve fleet-wide fuel efficiency and to help reduce the amount of petroleum consumed in the U.S., and therefore aims to improve this part of the U.S. balance of payments.

(3) Environmental Implications

Higher fleet fuel economy reduces U.S. emissions of CO₂ as well as various other pollutants by reducing the amount of oil that is produced and refined for the U.S. vehicle fleet, but can also potentially increase emissions by reducing the cost of driving, which can result in increased vehicle miles traveled (*i.e.*, the rebound effect). Thus, the net effect of more stringent CAFE standards on emissions of each pollutant depends on the relative magnitudes of its reduced emissions in fuel refining and distribution and increases in its emissions from vehicle use. Fuel savings from CAFE standards also necessarily result in lower emissions of CO₂, the main greenhouse gas emitted as a result of refining, distribution, and use of transportation fuels.

NHTSA has considered environmental issues, both within the context of EPCA and the context of the National Environmental Policy Act (NEPA), in making decisions about the setting of standards since the earliest days of the CAFE program. As courts of appeal have noted in three decisions stretching over the last 20 years,⁹⁸³ NHTSA defined “the need of the United States to conserve energy” in the late 1970s as including, among other things, environmental implications. In 1988, NHTSA included climate change concepts in its CAFE notices and prepared its first environmental assessment addressing that subject.⁹⁸⁴ It cited concerns about climate change as one of the reasons for limiting the extent

⁹⁸² California Attorney General et al., at 25.

⁹⁸³ CAS, 793 F.2d 1322, 1325 n. 12 (D.C. Cir. 1986); Public Citizen, 848 F.2d 256, 262–63 n. 27 (D.C. Cir. 1988) (noting that “NHTSA itself has interpreted the factors it must consider in setting CAFE standards as including environmental effects”); CBD, 538 F.3d 1172 (9th Cir. 2007).

⁹⁸⁴ 53 FR 33080, 33096 (Aug. 29, 1988).

of its reduction of the CAFE standard for MY 1989 passenger cars.⁹⁸⁵

NHTSA also considers environmental justice issues as part of the environmental considerations under the need of the U.S. to conserve energy, per Executive Order 12898, "Federal Actions to Address Environmental Justice in Minority Populations and Low-Income Populations."⁹⁸⁶ and DOT Order 5610.2(c), "U.S. Department of Transportation Actions to Address Environmental Justice in Minority Populations and Low-Income Populations."⁹⁸⁷ The affected environment for environmental justice is nationwide, with a focus on areas that could contain minority and low-income communities who would most likely be exposed to the environmental and health effects of oil production, distribution, and consumption, or the impacts of climate change. This includes areas where oil production and refining occur, areas near roadways, coastal flood-prone areas, and urban areas that are subject to the heat island effect.

Numerous studies have found that some environmental hazards are more prevalent in areas where minority and low-income populations represent a higher proportion of the population compared with the general population. In terms of effects due to criteria pollutants and air toxics emissions, the body of scientific literature points to disproportionate representation of minority and low-income populations in proximity to a range of industrial, manufacturing, and hazardous waste facilities that are stationary sources of air pollution, although results of individual studies may vary. While the scientific literature specific to oil refineries is limited, disproportionate exposure of minority and low-income populations to air pollution from oil refineries is suggested by other broader studies of racial and socioeconomic disparities in proximity to industrial facilities generally. Studies have also consistently demonstrated a disproportionate prevalence of minority and low-income populations that are living near mobile sources of pollutants (such as roadways) and therefore are exposed to higher concentrations of criteria air pollutants in multiple locations across the United States. Lower-positioned socioeconomic groups are also differentially exposed to air pollution and differentially vulnerable to effects of exposure.

In terms of exposure to climate change risks, the literature suggests that across all climate risks, low-income communities, some communities of color, and those facing discrimination are disproportionately affected by climate events. Communities overburdened by poor environmental quality experience increased climate risk due to a combination of sensitivity and exposure. Urban populations experiencing inequities and health issues have greater susceptibility to climate change, including substantial temperature increases. Some communities of color facing cumulative exposure to multiple pollutants also live in areas prone to climate risk. Indigenous peoples in the United States face increased health disparities that cause increased sensitivity to extreme heat and air pollution. Together, this information indicates that climate impacts disproportionately affect minority and low-income populations because of socioeconomic circumstances, histories of discrimination, and inequity. Furthermore, high temperatures can exacerbate poor air quality, further compounding the risk to overburdened communities. Finally, health-related sensitivities in low-income and minority populations increase risk of damaging impacts from poor air quality under climate change, underscoring the potential benefits of improving air quality to communities overburdened by poor environmental quality.

In the Final SEIS, Chapters 3, 4, 5, and 8 discuss the connections between oil production, distribution, and consumption, and their health and environmental impacts.

All of the action alternatives considered in this final rule reduce carbon dioxide emissions and, thus, the effects of climate change, as compared to the baseline. Effects on criteria pollutants and air toxics emissions are slightly more complicated, for a variety of reasons, as discussed in Section VI.C and Chapter 6.6 of the FRIA, although over time and certainly over the lifetimes of the vehicles that would be subject to this rule, these emissions are currently forecast to fall significantly. For example, the final rule analysis shows that increases in CAFE standards generally lead to decreases in overall emissions of NO_x and PM_{2.5} for all alternatives evaluated, in contrast to the NPRM analysis in which emissions of NO_x and PM_{2.5} for the more stringent alternatives surpassed the baseline (No-Action Alternative) and Alternative 1 in most calendar years. The differences between the NPRM and final rule are largely due to changes in the upstream

emission estimates of NO_x and PM_{2.5} from the updated GREET model (roughly 5–10 percent decline), as well as the lower consumption of electricity estimated in the final rule analysis. For SO_x, in contrast, the final rule analysis shows a similar trend to the NPRM, with overall emissions rising under the three most stringent alternatives, when compared to the baseline, while also marginally decreasing during a few of the middle years and then going up in the latter years for Alternative 1.

For toxic air pollutant emissions, the EIS runs that are part of the final rule analysis show findings consistent with what was shown for the NPRM analysis. Toxic air pollutant emissions across the action alternatives increase in 2025 (except for DPM), and generally show decreases in 2045 and 2050 relative to the No-Action Alternative for the same reasons as for criteria pollutants. In 2025, emissions of acetaldehyde, acrolein, benzene, 1,3-butadiene, and formaldehyde would increase under the action alternatives (compared to the No-Action Alternative), with the smallest increases occurring under Alternative 1, and the increases getting larger from Alternative 1 through Alternative 3. In 2035 and 2050, however, emissions of all toxic air pollutants would decrease under the action alternatives as compared to the No-Action Alternative. In 2035, the largest relative decreases in emissions would occur for DPM, for which emissions would decrease by as much as 6.1 percent under Alternative 3 compared to the No-Action Alternative. In 2050, the largest relative decreases in emissions would occur for formaldehyde, for which emissions would decrease by as much as 10 percent under Alternative 3 compared to the No-Action Alternative. Percentage decreases in emissions of acetaldehyde, acrolein, benzene, and 1,3-butadiene would be smaller.

As discussed above, while the majority of light-duty vehicles will continue to be powered by internal combustion engines in the near- to mid-term under all regulatory alternatives, the more stringent alternatives do appear in the analysis to lead to greater electrification in the mid- to longer-term. While NHTSA is prohibited from considering the fuel economy of electric vehicles in determining maximum feasible CAFE levels, electric vehicles (which appear both in the agency's baseline and which may be produced in model years following the period of regulation as an indirect effect of more stringent standards, or in response to other standards or to market demand) produce few to zero tailpipe emissions, and thus contribute meaningfully to the

⁹⁸⁵ 53 FR 39275, 39302 (Oct. 6, 1988).

⁹⁸⁶ 59 FR 629 (Feb. 16, 1994).

⁹⁸⁷ Department of Transportation Updated Environmental Justice Order 5610.2(c) (May 14, 2021).

decarbonization of the transportation sector, in addition to having environmental, health, and economic development benefits, although these benefits may not yet be equally distributed across society. They also present new environmental (and social) questions, like those associated with reduced tailpipe emissions, upstream electricity production, minerals extraction for battery components, and ability to charge an electric vehicle. The upstream environmental effects of extraction and refining for petroleum are well-recognized; minerals extraction and refining can also have significant downsides. As one example of documentation of these effects, the United Nations Conference on Trade and Development issued a report in July 2020 describing acid mine drainage and uranium-laced dust associated with cobalt mines in the Democratic Republic of the Congo, along with child labor concerns; considerable groundwater consumption and dust issues that harm miners and indigenous communities in the Andes; issues with fine particulate matter causing human health effects and soil contamination in regions near graphite mines; and so forth.⁹⁸⁸ NHTSA's Final SEIS discusses these and other effects (such as production and end-of-life issues) in more detail, and NHTSA will continue to monitor these issues going forward insofar as CAFE standards may increase electrification levels even if NHTSA does not expressly consider electrification in setting those standards, because NHTSA does not control what technologies manufacturers use to meet those standards, and because NHTSA is required to consider the environmental effects of its standards under NEPA.

NHTSA carefully considered the environmental effects of this rule, both quantitative and qualitative, as discussed in the Final SEIS and in Sections VI.C and VI.D.

A number of commenters pointed to the importance of climate change as a consideration of the need of the U.S. to conserve energy as a reason to set stringent standards.⁹⁸⁹ Mr. Douglas stated that “[t]he need of the United States to conserve energy now includes the need to avert the impending climate atrocity, and must therefore be given far

more weight than it has been given in the past. . . . it is now many orders of magnitude greater than it was before. The impending climate atrocity is going to make the OPEC oil embargo look like a picnic in the park. Technological and economic barriers are not so immovable that they cannot give way to the dramatically increased need to improve fuel economy.”⁹⁹⁰ The Great Lakes and Midwest Environmental Organizations commented that “[w]hile the Clean Air Act locates authority to regulate tailpipe greenhouse gas emissions from automobiles with the [EPA], NHTSA can and should still consider the effects of its automobile fuel efficiency standards on reducing the threat of climate change and its devastating impacts on the environment, agriculture, public health, and critical energy and transportation infrastructure.”⁹⁹¹ SELC noted that “NHTSA has always interpreted the need to conserve energy to include consideration of environmental implications. The significant environmental impacts of improved fuel economy deserve substantial weight in this rulemaking since greenhouse gas emissions from the combustion of fossil fuels continue to drive climate change.”⁹⁹² Our Children's Trust⁹⁹³ and Elders Climate Action⁹⁹⁴ both commented that if the final rule did not explain how it would specifically contribute to getting the United States to zero GHG emissions by 2050 or how it would reduce Earth's energy imbalance to zero, it would be arbitrary and capricious. Mr. Kreucher, in contrast, commented that the climate benefits associated with the proposal were extremely small, as noted in the SEIS.⁹⁹⁵

Other commenters argued that the idea that the “need of the U.S. to conserve energy” includes climate considerations has been upheld in case law. California Attorney General et al. stated that NHTSA “. . . has long considered environmental impacts as part of the need of the U.S. to conserve energy, and this interpretation has been approved by both the D.C. Circuit and the Ninth Circuit.”⁹⁹⁶ IPI et al. similarly commented that:

For decades, courts have affirmed that this language does not bar, but in fact compels NHTSA to consider the environmental

implications of energy conservation, including effects on climate change. In 1988 the [D.C. Circuit] highlighted that [EPCA] contains no statutory command prohibiting environmental considerations recognizing “no conflict” between considering “environmental consequences” with “the factors NHTSA must weigh under EPCA.” [citing Public Citizen, 848 F.2d 256, 263 n. 17 (D.C. Cir. 1988)] The court further approved of [DOT's] interpretation that the reference to “the need of the United States to conserve energy” “requires consideration of . . . environmental . . . implications.” [*Id.*] More recently, in 2008, the [9th Circuit] indicated that, due to advancements “in scientific knowledge of climate change and its causes,” “the need of the United States to conserve energy is even more pressing today than it was at the time of EPCA's enactment.” [citing CBD, 538 F.3d 1172, at 1197–98] Accordingly, the court concluded ‘EPCA does not limit NHTSA's duty . . . to assess the environmental impacts, including the impact on climate change, of its rule.’ [*Id.* at 1214].”⁹⁹⁷

In response, NHTSA agrees that the agency has cited climate as a consideration relevant to the need of the U.S. to conserve energy for several decades of CAFE rulemakings, and that that practice has been upheld in court. NHTSA thus considers climate effects as part of its determination of maximum feasible standards, although they are fairly straightforward—more stringent standards obviously reduce emissions further, and less stringent standards reduce them less. Climate effects will be discussed in more specific detail in Section VI.D below.

On the other hand, while climate effects represent one reason the Nation needs to conserve energy, there are other reasons, and NHTSA's approach carefully considers these, as well, in part by including a range of estimated types of energy-related benefits and costs in the agency's overall benefit-cost analysis. Moreover, while some commenters cite agreements under the UNFCCC as necessitating more stringent CAFE standards, and the U.S. has, for example, rejoined the “Paris Accord,” we note that any commitments the U.S. has made under the UNFCCC involve aggregate greenhouse gas emissions, not emissions from any specific sector. NHTSA can consider climate effects as an aspect of the need of the United States to conserve energy, but climate effects are one of a number of aspects that the agency considers. NHTSA considers all aspects of the need of the United States to conserve energy, and then balances those considerations with the other factors given to us by statute (and their attendant considerations).

⁹⁸⁸ UNCTAD, “Commodities at a Glance: Special issue on strategic battery raw materials,” No. 13, Geneva, 2020, at 46. Available at https://unctad.org/system/files/official-document/ditccom2019d5_en.pdf (accessed: March 15, 2022) and in the docket for this rulemaking, NHTSA–2021–0053.

⁹⁸⁹ See, e.g., Lucid, at 4; CARB, at 15; Bay Area Quality Management Air District, NHTSA–2021–0053–1472, at 5.

⁹⁹⁰ Peter Douglas, at 14, 16–17.

⁹⁹¹ Great Lakes and Midwest Environmental Organizations, at 2.

⁹⁹² SELC, at 2.

⁹⁹³ Our Children's Trust, at 6; Elders Climate Action, Docket No. NHTSA–2021–0053–1589, at 2.

⁹⁹⁴ Elders Climate Action, Docket No. NHTSA–2021–0053–1589, at 2.

⁹⁹⁵ Walter Kreucher, at 10.

⁹⁹⁶ California Attorney General et al., at 8–9, 25.

⁹⁹⁷ IPI, Docket No. NHTSA–2021–0053–1547, at 5.

A number of commenters also noted environmental justice and equity concerns. Great Lakes and Midwest Environmental Organizations, ELPC, SELC, CARB, California Attorney General et al., CBD et al., ACEEE, and Chicago Metropolitan Agency for Planning all echoed NHTSA's discussion of these topics from the NPRM.⁹⁹⁸ California Attorney General et al. also noted that reducing criteria pollutants and air toxics "is crucial to improve public health and to assist States in attaining and maintaining the NAAQS. Reductions in criteria pollutant emissions will also help mitigate some of the impact of climate change, including poor air quality and other impacts. . . . Moreover, reducing these emissions is critical to meeting our States and Cities' environmental justice goals. But we need federal help to reduce emissions that are outside our control and to meet those goals." ⁹⁹⁹ The Metropolitan Washington Council of Governments agreed and added that the proposed rule would also "provide considerable support for metropolitan Washington and communities across the United States to meet their GHG emissions reduction goals." ¹⁰⁰⁰

NHTSA continues to agree that environmental justice, like consumer fuel costs, are clearly an equity concern for low-income and historically disadvantaged communities, and vitally important to consider. Chapter 7 of the Final SEIS discusses NHTSA's consideration of environmental justice issues in detail. With regard to the comments about State NAAQS compliance, NHTSA reiterates that the final rule analysis shows that increases in CAFE standards generally lead to decreases in overall emissions of NO_x and PM_{2.5} for all alternatives evaluated, in contrast to the NPRM analysis in which emissions of NO_x and PM_{2.5} for the more stringent alternatives surpassed the baseline (No-Action Alternative) and Alternative 1 in most calendar years, and a trend for SO_x that is similar to the trend shown in the NPRM, with overall emissions rising under the three most stringent alternatives, when compared to the baseline, while also marginally decreasing during a few of the middle years and then going up in the latter

⁹⁹⁸ Great Lakes and Midwest Environmental Organizations, at 3; ELPC public hearing comments, at 2; SELC, at 4–5; CARB, at 17–18; California Attorney General et al., at 26; CBD et al., at 9; ACEEE, at 2; Chicago Metropolitan Agency for Planning, Docket No. NHTSA–2021–0053–0050, at 2.

⁹⁹⁹ California Attorney General et al., at 17–18.

¹⁰⁰⁰ Metropolitan Washington Council of Governments, Docket No. NHTSA–2021–0053–0048, at 2.

years for Alternative 1. As noted previously, contemporaneous effects to decarbonize the power sector could powerfully abate these emissions.

(4) Foreign Policy Implications

U.S. consumption and imports of petroleum products impose costs on the domestic economy that are not reflected in the market price for crude petroleum or in the prices paid by consumers for petroleum products such as gasoline. These costs include (1) higher prices for petroleum products resulting from the effect of U.S. oil demand on world oil prices; (2) the risk of disruptions to the U.S. economy, and the effects of those disruptions on consumers, caused by sudden increases in the global price of oil and its resulting impact of fuel prices faced by U.S. consumers, (3) expenses for maintaining the strategic petroleum reserve (SPR) to provide a response option should a disruption in commercial oil supplies threaten the U.S. economy, to allow the U.S. to meet part of its International Energy Agency obligation to maintain emergency oil stocks, and to provide a national defense fuel reserve, and (4) the threat of significant economic disruption, and the underlying effect on U.S. foreign policy, if an oil-exporting country threatens the United States and uses as part of its threat its power to upend the U.S. economy. Reducing U.S. consumption of crude oil or refined petroleum products (by reducing motor fuel use) can reduce these external costs.

In addition, a 2006 report by the Council on Foreign Relations identified six foreign policy costs that it said arose from U.S. consumption of imported oil: (1) The adverse effect that significant disruptions in oil supply will have for political and economic conditions in the U.S. and other importing countries; (2) the fears that the current international system is unable to ensure secure oil supplies when oil is seemingly scarce and oil prices are high; (3) political realignment from dependence on imported oil that limits U.S. alliances and partnerships; (4) the flexibility that oil revenues give oil-exporting countries to adopt policies that are contrary to U.S. interests and values; (5) an undermining of sound governance by the revenues from oil and gas exports in oil-exporting countries; and (6) an increased U.S. military presence in the Middle East that results from the strategic interest associated with oil consumption.

CAFE standards over the last few decades have conserved significant quantities of oil, and the petroleum intensity of the U.S. fleet has decreased

significantly. Continuing to improve energy conservation and reduce U.S. oil consumption by raising CAFE standards further has the potential to continue to help with all of these considerations.

EDF commented that CAFE standards were crucial for reducing "all oil consumption, not just foreign imports. Because oil is a global market, increasing domestic production will not insulate Americans from price fluctuations." ¹⁰⁰¹ Securing America's Future Energy and CBD et al. offered similar comments. ¹⁰⁰² California Attorney General et al. agreed, and suggested that climate change would cause more oil price shocks because extreme weather affects supply chains, and that more stringent CAFE standards would mitigate these risks. ¹⁰⁰³ CARB suggested "that NHTSA consider a broader range of sectors that can be impacted by oil imports and prices. This is expected to more accurately show the benefits from stricter standards, including on the budgets of the federal government and consumers."

NHTSA agrees with these comments, and will take CARB's suggestion under advisement for future rulemaking efforts, although this particular exercise may be beyond the scope of the agency's expertise. NHTSA looks forward to seeing scholarship develop further in this area as Brown (2018) describes the need for, above.

AFPM, in contrast, argued that the risks of oil price shocks had decreased substantially since EPCA was passed, due to increased U.S. energy exports, "Yet [the NPRM] would ignore these changed circumstances and trade our energy independence for a dependence on foreign supply chains for the commodities required to produce EV batteries." ¹⁰⁰⁴ Valero offered similar comments, and added that "promot[ing] the substantial use of electric vehicle technology" could "affirmatively undermine both energy security objectives and the market for domestically-produced renewable fuels that EISA and the RFS clearly seek to promote." ¹⁰⁰⁵ The High Octane Low Carbon Fuel Alliance also argued that increasing use of ethanol would displace more oil than would be saved by the NHTSA and EPA CAFE and GHG proposals together and produce "an oil

¹⁰⁰¹ EDF, at 6–7.

¹⁰⁰² Securing America's Future Energy, at 1; CBD et al., at 4.

¹⁰⁰³ California Attorney General et al., Appendix A, at 6–7.

¹⁰⁰⁴ AFPM, at 13.

¹⁰⁰⁵ Valero, Docket No. NHTSA–2021–0053–1541, at 2–3.

security premium valued at more than \$1 billion per year.”¹⁰⁰⁶

Auto Innovators commented that “energy security benefits are a less compelling rationale for the proposed standards and for the transition to EVs than they were when the CAFE program was created in 1975, and even when the Obama-era standards were finalized in 2012. This, of course, would weigh in favor of less stringent CAFE standards since the primary policy benefit supporting stringent fuel economy standards is the need of the nation to conserve energy.”¹⁰⁰⁷ Auto Innovators commented that “. . . GHG and CAFE standards seem unlikely to have any meaningful impact on imports from Canada and Mexico because U.S. buyers can obtain good prices, secure supplies, and/or long-term contracts from Canadian and Mexican producers. Since oil is produced, refined and sold in a global marketplace, the [agencies] should provide a rigorous analysis of which oil producers/refiners in the world will be adversely impacted by an incremental decline in U.S. demand for oil. This issue will be even more important in future rulemakings insofar as the agencies estimate much larger reductions in gasoline consumption.”¹⁰⁰⁸

While NHTSA agrees that the energy security picture has changed since the 1970s, due in no small part to the achievements of the CAFE program itself in increasing fleetwide fuel economy, as discussed in the NPRM, NHTSA disagrees that energy security in the petroleum consumption context is no longer of concern. Auto Innovators notes that oil is produced, refined, and sold in a global marketplace, and thus must realize that the fact that oil can be obtained from Canada and Mexico does not mean that prices cannot be affected by events occurring elsewhere in the world. Congress’ original concern with energy security was the impact of supply shocks on American consumers in the event that the U.S.’s foreign policy objectives lead to conflicts with oil-producing nations or that global events more generally lead to fuel disruptions, and improving fuel economy and reducing fuel consumption still helps with that. The world is dealing with these effects at the time this rule is being issued. In addition to the immediate human suffering caused by the Russian invasion of Ukraine, there has also been a significant increase in the price of

petroleum, caused by market concerns over both the invasion itself and the economic sanctions levied against Russia by the U.S. and many other countries. A motor vehicle fleet with greater fuel economy is better able to absorb increased fuel costs, particularly in the short-term, without those costs leading a broader economic crisis, as had occurred in the 1973 and 1979 oil crises. Thus, the U.S. is able to take certain economic actions in response to the invasion that would otherwise be unavailable, including the recent prohibition on Russian petroleum. Ensuring that the U.S. fleet is positioned to take advantage of the cost-effective technology innovations will allow the U.S. to continue to base its international activities on foreign policy objectives that are not limited, at least not completely, by petroleum issues.

Further, as explained above, when U.S. oil consumption is linked to the globalized and tightly interconnected oil market, as it is now, the only means of reducing the exposure of U.S. consumers to global oil shocks is to reduce their oil consumption and the overall oil-intensity of the U.S. economy. U.S. oil supply does not effectively insulate U.S. drivers from higher gas prices (or other price increases driven by oil prices), because those prices are currently largely determined by oil prices set in the globally integrated market. Given these dynamics, the most effective policies to protect consumers from oil price spikes are those that reduce the oil-intensity of the economy, including fuel economy standards. Thus, the reduction in oil consumption driven by fuel economy standards creates an energy security benefit.

This benefit is the original purpose behind the CAFE standards. Oil prices are inherently volatile, in part because geopolitical risk affects prices. International conflicts, sanctions, civil conflicts targeting oil production infrastructure, pandemic-related economic upheaval, cartels have all had dramatic and sudden effects on oil prices in recent years. For all of these reasons, energy security remains quite relevant for NHTSA in determining maximum feasible CAFE standards. There are extremely important energy security benefits associated with raising CAFE stringency that are not discussed in TSD Chapter 6.2.4, and which are difficult to quantify, but have weighed heavily for NHTSA in determining the maximum feasible standards in this final rule.

Regarding the comments about the energy security benefits of ethanol use, these are, for the most part, beyond the

scope of the CAFE program. Flex-fueled vehicles capable of running on ethanol are incentivized by EPA’s CAFE calculation regulations, and generally speaking, the benefit depends on the amount of ethanol actually consumed by the vehicles.

Regarding climate risks in particular, ELPC commented at the public hearing that increasing CAFE standards improved national security because “The impacts of climate change include impacts on the environment, agriculture, public health, and infrastructure, including critical energy and transportation infrastructure, that can compromise America’s energy security and national security.”¹⁰⁰⁹ Tesla agreed that reducing climate impacts can benefit national security.¹⁰¹⁰ California Attorney General et al. agreed that reducing fuel use can benefit our national security, including insofar as the environmental costs of oil use are intertwined with the security costs of oil use.¹⁰¹¹ Elders Climate Action argued that NHTSA had not enumerated specifically “what must be achieved . . . with respect to emissions reductions to protect the national security, what its ‘long-term GHG reduction goals’ are, how it intends to achieve them, or whether and how the current rulemaking contributes to achieving those goals.”¹⁰¹²

NHTSA agrees that climate effects in turn affect national (and global) security, as also discussed in the NPRM. However, this is a consideration for estimating the social cost of carbon. NHTSA lacks any empirical basis to quantify these potential effects beyond the point they have already been accounted for by the interagency working group (IWG) charged with estimating the social cost of carbon.

With regard to military security specifically, Securing America’s Future Energy commented that “[a]ccording to [our] Energy Security Leadership Council . . . member and former Secretary of the Navy John F. Lehman, ‘more than half the Defense budget is for the security of Persian Gulf oil.’ And ‘defending Persian Gulf oil is a major distraction from existential defense issues. Oil dependency complicates the military equation beyond our comprehension.’”¹⁰¹³ Securing America’s Future Energy also commented that the U.S. was falling behind China on vehicle electrification,

¹⁰⁰⁶ High Octane Low Carbon Fuel Alliance, Docket No. NHTSA–2021–0053–1475, at 6.

¹⁰⁰⁷ Auto Innovators, at 21.

¹⁰⁰⁸ Auto Innovators, at 93.

¹⁰⁰⁹ ELPC public hearing comments, at 1–2.

¹⁰¹⁰ Tesla, Attachment 1, at 3.

¹⁰¹¹ California Attorney General et al., at 7–8 (citing Brown, 2018).

¹⁰¹² Elders Climate Action, at 11.

¹⁰¹³ Securing America’s Future Energy, at 9.

and that losing automotive manufacturing capacity (if this was allowed to continue) “would not only threaten our economy and millions of jobs, but it could also undermine our capacity to innovate, with implications extending to the military and defense industry.”¹⁰¹⁴ Securing America’s Future Energy therefore argued that “[u]sing the regulatory powers of the federal government is an important tool in creating the demand for EVs that are the engine of that transition, and . . . the fuel economy rule should be developed in a manner to accelerate this critical transition.”¹⁰¹⁵

In response, while NHTSA does not consider the fuel economy of EVs expressly in determining maximum feasible CAFE standards, NHTSA appreciates the comments from Securing America’s Future Energy and recognizes that reducing global oil consumption by raising CAFE standards can improve national security, which may facilitate reduced military spending. Chapter 6 of the TSD discusses these issues in more detail.

To the extent that the U.S. light-duty vehicle fleet toward electrification, different potential foreign policy implications arise. Most vehicle

electrification is currently enabled by lithium-ion batteries. Lithium-ion battery global value chains have several phases: Sourcing (mining/extraction); processing/refining; cell manufacturing; battery manufacturing; installation in an EV; and recycling.¹⁰¹⁶ Because lithium-ion battery materials have a wide global diversity of origin, accessing them can pose varying geopolitical challenges.¹⁰¹⁷ The U.S. International Trade Commission recently summarized 2018 data from the U.S. Geological Survey on the production/sourcing of the four key lithium-ion battery materials, as shown in Table VI–9.

Table VI-9 – Lithium-ion Battery Materials Mining Production, 2018¹⁰¹⁸

Lithium-ion Battery Material Ores and Concentrates	Countries with Largest Mining Production (Share of Global Total)	U.S. Mining Production (Share of Global Total)
Lithium	Australia (60 percent), Chile (19 percent), China (9 percent), Argentina (7 percent)	USITC staff estimates less than 1 percent
Cobalt	Democratic Republic of Congo (64 percent), Cuba (4 percent), Russia (4 percent), Australia (3 percent)	Less than 0.5 percent
Graphite (natural)	China (68 percent), Brazil (10 percent), India (4 percent)	0 percent
Nickel	Indonesia (24 percent), Philippines (15 percent), Russia (9 percent)	Less than 1 percent

Of these sources, the USITC notes that while “lithium has generally not faced political instability risks,” “[b]ecause of the [Democratic Republic of Congo’s] ongoing political instability, as well as poor labor conditions, sourcing cobalt faces significant geopolitical challenges.”¹⁰¹⁹ Nickel is also used extensively in stainless steel production, and much of what is produced in Indonesia and the Philippines is currently exported to China for stainless steel manufacturing.¹⁰²⁰ Obtaining graphite for batteries does not currently pose geopolitical obstacles, but the USITC notes that Turkey has great potential to become a large graphite producer,

which would make stability there a larger concern.¹⁰²¹

For materials processing and refining, China is the largest importer of unprocessed lithium, which it then transforms into processed or refined lithium,¹⁰²² the leading producer of refined cobalt (with Finland a distant second),¹⁰²³ one of the leading producers of primary nickel products (along with Indonesia, Japan, Russia, and Canada) and one of the leading refiners of nickel into nickel sulfate, the chemical compound used for cathodes in lithium-ion batteries,¹⁰²⁴ and one of the leading processors of graphite intended for use in lithium-ion batteries as well.¹⁰²⁵ In all regions, increasing attention is being given to vertical integration in the lithium-ion battery

industry from material extraction, mining and refining, battery materials, cell production, battery systems, reuse, and recycling. The United States is lagging in upstream capacity; although the U.S. has some domestic lithium deposits, it has very little capacity in mining and refining any of the key raw materials. As mentioned elsewhere, however, there can be benefits and drawbacks in terms of environmental consequences associated with increased mining, refining, and battery production.

China and the European Union are also major consumers of lithium-ion batteries, along with Japan, Korea, and others. Lithium-ion batteries are used not only in light-duty vehicles, but in many ubiquitous consumer goods, and

¹⁰¹⁴ *Id.* at 5.

¹⁰¹⁵ *Id.* at 5.

¹⁰¹⁶ Scott, Sarah, and Robert Ireland, “Lithium-Ion Battery Materials for Electric Vehicles and their Global Value Chains,” Office of Industries Working Paper ID-068, U.S. International Trade Commission, June 2020, at 7. Available at https://www.usitc.gov/publications/332/working_papers/gvc_overview_scott_ireland_508_final_061120.pdf and in the docket for this rulemaking, NHTSA–2021–0053.

¹⁰¹⁷ *Id.* at 8.

¹⁰¹⁸ *Id.*, citing U.S. Geological Survey, Mineral

Commodity Summaries, Feb. 2019.

¹⁰¹⁹ *Id.* at 8, 9.

¹⁰²⁰ *Id.* at 9.

¹⁰²¹ *Id.*

¹⁰²² *Id.*

¹⁰²³ *Id.* at 10.

¹⁰²⁴ *Id.*

¹⁰²⁵ *Id.*

are likely to be used eventually in other forms of transportation as well. Thus, securing sufficient batteries to enable large-scale shifts to electrification in the U.S. light-duty vehicle fleet may face new issues as vehicle companies compete with other new sectors. NHTSA will continue to monitor these issues going forward.

President Biden has already issued an Executive order on “America’s Supply Chains,” aiming to strengthen the resilience of America’s supply chains, including those for automotive batteries.¹⁰²⁶ Reports are to be developed within one year of issuance of the Executive order, and NHTSA will monitor these findings as they develop.

Securing America’s Future Energy commented that “[a]s we navigate the transition to electrification, we must ensure that we do not swap our current dependence on an unstable oil market for reliance on China for our future transportation needs.”¹⁰²⁷ The UAW similarly commented that “[i]t is projected that by 2029, 70 percent of lithium-ion battery manufacturing capacity will be in China and another 16 percent will be in Europe. Without significant efforts to increase domestic production, the U.S. could be left behind, with just 9 percent of global battery production capacity.”¹⁰²⁸ Auto Innovators echoed many of the issues NHTSA raised in the NPRM regarding minerals sourcing and availability.¹⁰²⁹

AFPM argued that NHTSA “fails to address” the fact that “The current Administration has cancelled mineral development projects in the U.S., which increases U.S. dependence on other countries to supply minerals required to meet the demand from its policies, including this rulemaking.”¹⁰³⁰ AFPM further argued that:

Transportation electrification requires substantial, foreign-sourced raw and processed materials to produce EVs and batteries. This proposal, taken to its logical end, would put the United States into a situation resembling the oil embargoes of the 1970s, where unreliable foreign states whose interests often do not align with the United States’, control majorities of the critical raw material supplies used in the manufacturing of batteries and motor components required for transportation services. . . . Increasing dependence on foreign sources of energy and materials cannot be what Congress intended.

¹⁰²⁶ Executive Order 14017, “America’s Supply Chains,” Feb. 24, 2021, 86 FR 11849 (Mar. 1, 2021).

¹⁰²⁷ Securing America’s Future Energy, at 2.

¹⁰²⁸ UAW, citing testimony to Congress by Benchmark Mineral Intelligence in 2020, available at <https://www.energy.senate.gov/services/files/6A3B3A00-8A72-4DC3-8342-F6A7B9B33FEF>. (Accessed: March 15, 2022)

¹⁰²⁹ Auto Innovators, at 108–115.

¹⁰³⁰ AFPM, at 15.

This is not the renewed focus on energy conservation and security risk reduction that NHTSA promises in the proposal.¹⁰³¹

In contrast, EDF commented that the battery supply chain issues were improving, that President Biden had made increasing domestic supply a priority, that industry was responding by investing domestically and developing battery chemistries whose minerals might be easier to source reliably, and that perhaps industry would develop greater recycling capabilities in the future.¹⁰³²

Another security-related consideration of increasing fleet electrification is electricity supply. CARB commented that energy security considerations change with electrification, and that “[w]ith a possible large-scale shift to electrify the transportation sector, any future discussion around energy security would benefit from considering the availability of a sufficient supply or availability of electricity as well as petroleum.”¹⁰³³

While NHTSA agrees that all of these considerations bear ongoing attention, as discussed in greater detail below, the agency is prohibited from considering the fuel economy of electric vehicles in setting the standards. Independent of that consideration, we do not believe that this issue is entirely ripe in this rulemaking establishing CAFE standards for MYs 2024–2026 given the low electrification rates, even among the most stringent alternatives. As stated above, NHTSA will continue to monitor these issues going forward.

(e) Factors That NHTSA is Prohibited From Considering

EPCA also provides that in determining the level at which it should set CAFE standards for a particular model year, NHTSA may not consider the ability of manufacturers to take advantage of several EPCA provisions that facilitate compliance with CAFE standards and thereby reduce the costs of compliance.¹⁰³⁴ NHTSA cannot consider compliance credits that manufacturers earn by exceeding the CAFE standards and then use to achieve compliance in years in which their measured average fuel economy falls below the standards. NHTSA also cannot consider the use of alternative fuels by dual fueled automobiles, nor the fuel economy (*i.e.*, the availability) of dedicated alternative fueled automobiles—including battery-electric

vehicles—in any model year for which standards are being set. EPCA encourages the production of alternative fuel vehicles by specifying that their fuel economy is to be determined using a special calculation procedure that results in those vehicles being assigned a higher equivalent fuel economy level than they actually achieve.

The effect of the prohibitions against considering these statutory flexibilities in setting the CAFE standards is that the flexibilities remain voluntarily employed measures. If NHTSA were instead to assume manufacturer use of those flexibilities in setting new standards (as NHTSA does in the “EIS analysis,” but not the “standard setting analysis”), compliance with higher standards would appear more cost-effective and, potentially, more feasible, which would thus effectively require manufacturers to use those flexibilities if NHTSA determined that standards should be more stringent. By keeping NHTSA from including them in our stringency determination, the provision ensures that those statutory credits remain true compliance flexibilities. However, the flip side of the effect described above is that preventing NHTSA from assuming use of dedicated alternative fuel vehicles for compliance makes it more difficult for the CAFE program to facilitate a complete transition of the U.S. light-duty fleet to full electrification.

In contrast, for the non-statutory fuel economy improvement value program that NHTSA developed by regulation, NHTSA does not consider these fuel economy adjustments subject to the 49 U.S.C. 32902(h) prohibition on considering flexibilities. The statute is very clear as to which flexibilities are not to be considered. When the agency has introduced additional flexibilities such as AC efficiency and “off-cycle” technology fuel improvement values, NHTSA has considered those technologies as available in the analysis. Thus, this analysis includes assumptions about manufacturers’ use of those technologies, as detailed in Chapter 3.8 of the accompanying TSD.

NHTSA notes that one of the recommendations in the 2021 NAS Report was for Congress to “amend the statute to delete the [49 U.S.C. 32902(h)] prohibition on considering the fuel economy of dedicated alternative fueled vehicles in setting CAFE standards.”¹⁰³⁵ Mr. Douglas also commented that new legislation was needed to remove this restriction.¹⁰³⁶

¹⁰³¹ *Id.* at 14.

¹⁰³² EDF, at 7–9.

¹⁰³³ CARB, at 11.

¹⁰³⁴ 49 U.S.C. 32902(h).

¹⁰³⁵ 2021 NAS Report, Summary Recommendation 5.

¹⁰³⁶ Peter Douglas, at 6.

Recognizing that changing statutory text is Congress' affair and not NHTSA's, the NAS committee further recommended that if Congress does not change the statute, NHTSA should consider adding another attribute to the fuel economy standard function, like "the expected market share of ZEVs in the total U.S. fleet of new light-duty vehicles—such that the standards increase as the share of ZEVs in the total U.S. fleet increases."¹⁰³⁷ NHTSA sought comment on this recommendation in the proposal, but is not pursuing it at this time, as discussed further in Section III.B.

While NHTSA does not consider the prohibited items in its standard-setting analysis or for making its decision about what levels of standards would be maximum feasible, NHTSA notes that they are included in the "EIS" analysis presented in the FRIA appendix. The EIS analysis does not contain these restrictions, and therefore accounts for credit availability and usage, and manufacturers' ability to employ alternative fueled vehicles, for purpose of conformance with E.O. 12866 and NEPA regulations. Under the EIS analysis, compliance generally appears less costly. For example, this EIS analysis shows manufacturers' incremental costs (vs. the No-Action Alternative) averaging about \$1,000 in MY 2029 under the final standards, as compared to the \$1,087 shown by the standard setting analysis. Again, however, for purposes of determining maximum feasible CAFE levels, NHTSA considers only the standard setting analysis shown in this final rule, consistent with Congress' direction.

Auto Innovators commented that "[i]n order to be faithful to both the text and the intent of Section 32902(h), NHTSA must completely exclude the sale of BEVs and the electric portion of the operation of PHEVs from its standard-setting analyses, unless and until Congress modifies the prohibitions against their inclusion in setting maximum feasible standards."¹⁰³⁸ Discussing further their understanding of Congress' intent, Auto Innovators argued that:

The structure of EPCA—where by the fuel economy of EVs must be excluded from the standard setting but are included in a manufacturer's compliance fleet—was intentionally crafted by Congress in order to incentivize automaker investments in the manufacture and sale of such alternative fuel vehicles. . . . NHTSA's inclusion of EVs in its standard-setting here, coupled with EPA's different treatment of these vehicles for GHG

compliance purposes, has the exact opposite effect. Rather than disincentivize EVs, at a minimum, the CAFE program should not stand as an obstacle to achieving the nation's electrification goals.¹⁰³⁹

Kia commented that "[d]ue to NHTSA's statutory restriction on including dedicated EVs in its evaluation of all technical pathways that can be taken, [Kia] suggests that NHTSA should consider re-evaluating its stringency levels in this rulemaking."¹⁰⁴⁰ AFPM offered similar comments,¹⁰⁴¹ as did Stellantis.¹⁰⁴² Mr. Kreucher commented that "[o]nce [dedicated and dual fueled AFVs] are excluded from consideration, the . . . CAFE Model and assumptions demonstrates that the proposed standards ARE NOT technologically feasible."¹⁰⁴³

Auto Innovators also argued that for NHTSA even to describe vehicle electrification as a policy goal was "duplicative and confusing" because "one of the central aims of EPA's light-duty greenhouse gas standards is to reduce emissions of those gases to address climate change concerns," and "[i]t is not the role of NHTSA to pick technology pathways for reducing energy use and associated greenhouse gas emissions."¹⁰⁴⁴ Instead, Auto Innovators argued that "[a]lthough reductions in greenhouse gas emissions are an effect of fuel economy improvements, the primary purposes of the CAFE program are to improve energy efficiency of motor vehicles, and to move the U.S. toward greater energy independence and security."¹⁰⁴⁵

With regard to the provision at 49 U.S.C. 32902(h)(2), Auto Innovators commented that "[f]or purposes of the standard-setting analysis, NHTSA should consider only the fuel economy of a PHEV when operating on conventional fuel."¹⁰⁴⁶ Stellantis offered similar comments.¹⁰⁴⁷

In contrast, NCAT agreed that NHTSA cannot consider the fuel economy of alternative fuel vehicles when deciding maximum feasible CAFE standards, and stated that "[t]herefore, NHTSA does not consider the fuel economy of alternative fuel vehicles when deciding how much more fuel efficient passenger cars and light trucks should become in MY 2024–2026 when setting the 'maximum feasible average fuel

economy' levels."¹⁰⁴⁸ (emphasis in original). California Attorney General et al. argued that:

. . . by excluding increased adoption of ZEV technology (and credit trading) from its modeling of fuel economy improvements, NHTSA ensures that these potential compliance strategies are not essential to achieving such improvements in the fleet average. Thus, NHTSA's regulatory analysis of the proposed action alternatives remains focused exclusively on the fuel economy improvements automakers could make to their [ICE] vehicles and without trading in the relevant compliance period.¹⁰⁴⁹

Tesla commented that 49 U.S.C. 32902(h) "does not prohibit . . . ZEV-related considerations such as the effect [that CAFE standards] will have on the market share of ZEVs and the degree to which electrification provides positive consumer cost benefits and favorable automaker compliance strategies."¹⁰⁵⁰

With regard to consideration of credits in determining maximum feasible CAFE standards, AFPM argued that all manufacturers were relying on credits for compliance with the current standards, and stated that "NHTSA has not demonstrated that manufacturers can meet more stringent standards within the confines of EPCA's guardrails. In fact, knowing that manufacturers have been relying on credits to meet the current standard and then proposing to tighten them is arbitrary and capricious and contrary to the explicit statutory prohibition on considering credits when setting maximum feasible fuel economy standards."¹⁰⁵¹

In response, NHTSA interprets 49 U.S.C. 32902(h) as applying to NHTSA's determination of what standards are maximum feasible, and as allowing NHTSA to reflect the very real existence of dedicated and dual-fueled alternative fueled vehicles in the analytical baseline, as discussed in more detail in Section IV above. NHTSA also interprets 32902(h) as not prohibiting application by the CAFE Model of vehicles such as EVs in model years outside the rulemaking time frame, for example in MYs 2027 and beyond in this analysis, because those years are not the ones for which we are currently determining CAFE standards. NHTSA agrees that the intent of 32902(h), when combined with the other statutory incentives in EPCA such as those at 49 U.S.C. 32905 and 32906, was to encourage production of alternative fueled vehicles. NHTSA disagrees that

¹⁰³⁹ *Id.*, at 25.

¹⁰⁴⁰ Kia, at 3.

¹⁰⁴¹ AFPM, at 2.

¹⁰⁴² Stellantis, at 2–3.

¹⁰⁴³ Walt Kreucher, at 5.

¹⁰⁴⁴ Auto Innovators, at 15–16.

¹⁰⁴⁵ *Id.*

¹⁰⁴⁶ *Id.*, at 43.

¹⁰⁴⁷ Stellantis, at 2–3.

¹⁰⁴⁸ NCAT, at 9.

¹⁰⁴⁹ California Attorney General et al., Appendix A, at 40.

¹⁰⁵⁰ Tesla, Attachment 1, at 4.

¹⁰⁵¹ AFPM, at 3–4.

¹⁰³⁷ *Id.*

¹⁰³⁸ Auto Innovators, at 47.

the approach taken here to modeling the current existence of alternative fueled vehicles (AFVs) and their possible application in model years beyond those for which we are setting standards in any way disincentivizes their application or conflicts with EPA or Administration electrification goals. As long as the *actual* compliance treatment of AFVs is unchanged, production of AFVs is more strongly encouraged by more stringent standards, irrespective of the analysis informing decisions about those standards.

NHTSA disagrees that constraints on its analysis should be applied beyond the specific model years for which the agency is issuing new CAFE standards, and notes that the wider NHTSA applies these constraints, the more it is forced to divorce its analysis from reality. Nevertheless, noting related comments discussed above, NHTSA has expanded its sensitivity analysis to apply these constraints throughout MYs 2023–2029. This case, therefore, excludes the potential application of compliance credits throughout MYs 2023–2029, as well as the introduction of new BEV models beyond those projected to be introduced in MYs 2021–2022 and/or in response to the ZEV mandate. This sensitivity case shows estimated average incremental costs (including civil penalties) under the Preferred Alternative increasing from \$240–\$1,216 per vehicle during MYs 2023–2029 in the reference case to about \$384–\$1,371, with differences varying further between regulatory alternatives and among manufacturers. Differences in broader societal impacts (*e.g.*, benefits and costs) are presented above in Section V.

In *Massachusetts v. EPA*, the Supreme Court suggested that both EPA and NHTSA could implement their programs concurrently, and that is what NHTSA is doing in this rulemaking. We agree that the overarching purpose of EPCA is energy conservation, and that reducing GHG emissions is an effect of improving fuel economy. Noting Administration electrification goals, and even aspiring to see the new light-duty fleet head in that direction, is not a violation of 49 U.S.C. 32902(h). It is always up to manufacturers what technology path they take to meet CAFE standards, and the CAFE standards do not mandate a path that involves electrification even while acknowledging that electric vehicles exist in the fleet and may be applied in future model years beyond those for which we are now setting standards. Moreover, contrary to Mr. Kreucher's suggestion, NHTSA finds that standards are maximum feasible without

electrification beyond what is already expected in the baseline.

In response to the industry comments regarding how NHTSA considers the fuel economy of dual-fueled vehicles in determining maximum feasible CAFE standards, NHTSA has held the interpretation since the 2012 final rule that it is reasonable and appropriate to begin considering the full calculated fuel economy of dual-fueled vehicles. Moreover, given that the costs of hybridization and electrification continue to fall, NHTSA continues to believe that it is foreseeable that manufacturers will comply with future CAFE standards using PHEVs (and BEVs, for that matter), and if costs continue on this path, then industry compliance costs will be even lower than what we currently estimate. In response to these comments, however, NHTSA conducted a sensitivity analysis, presented in Chapter 7 of the FRIA. Findings from that analysis indicate that even if NHTSA constrained PHEV applicability in the CAFE Model during the rulemaking time frame, results in MY 2029 would be extremely close to results in the main standard-setting analysis. For Alternative 2.5, per-vehicle costs are estimated to drop from \$1,087 to \$1,072; SHEV adoption industry-wide would increase from 21 to 27 percent; BEV adoption industry-wide would increase from 6.7 percent to just 6.9 percent; along with other minor shifts in engine and vehicle technologies. Thus, NHTSA concludes that even if we had run standard setting with this restriction, the extremely small differences in results would not have led us to change our decision about how we are balancing the statutory factors or what levels of fuel economy would be maximum feasible in the rulemaking time frame. With regard to AFPM's comment that it is arbitrary and capricious and a violation of 49 U.S.C. 32902(h) for NHTSA to increase CAFE stringency when automakers have been using credits in recent years toward compliance, in order to rely on the fact that automakers have been using credits as a basis not to increase CAFE stringency, NHTSA would have to *consider the availability of credits*, contrary to 32902(h).¹⁰⁵² While NHTSA is aware that the past several model years have been more challenging ones for CAFE compliance for a variety of reasons, as discussed in Section VI.A.5.b) above, NHTSA continues to believe that the technology exists to raise fuel economy consistent with the

¹⁰⁵² This is sometimes described as the “white bear problem.”

levels represented by the action alternatives in this final rule, and that manufacturers are ready to begin applying it, consistent with their public positions about heading toward zero emissions fleets. Further, NHTSA does not view the use of banked credits as anything other than an indication that program flexibilities are working as intended to allow automakers to optimize compliance over time and thereby to reduce compliance costs.

(f) Other Considerations in Determining Maximum Feasible CAFE Standards

NHTSA has historically considered the potential for adverse safety effects in setting CAFE standards. This practice has been upheld in case law.¹⁰⁵³ South Coast AQMD commented that “NHTSA is . . . correct to abandon the SAFE Rule’s arbitrary focus on non-statutory factors including its flawed theory crediting reduced fuel economy with fewer fatalities due to consumers choosing to drive less.”¹⁰⁵⁴ While NHTSA agrees that the safety effects of the different regulatory alternatives are in no way dispositive for the agency’s decision in this final rule, NHTSA still considers the safety effects, consistent with case law. The agency’s findings are discussed in Section V of this preamble and in Chapter 5 of the accompanying FRIA, and NHTSA discusses its consideration of these effects in Section VI.D.

B. Administrative Procedure Act

The Administrative Procedure Act governs agency rulemaking generally and provides the standard of judicial review for agency actions. To be upheld under the “arbitrary and capricious” standard of judicial review under the APA, an agency rule must be rational, based on consideration of the relevant factors, and within the scope of the authority delegated to the agency by statute. The agency must examine the

¹⁰⁵³ As courts have recognized, “NHTSA has always examined the safety consequences of the CAFE standards in its overall consideration of relevant factors since its earliest rulemaking under the CAFE program.” *Competitive Enterprise Institute v. NHTSA*, 901 F.2d 107, 120 n. 11 (DC Cir. 1990) (“CEI-I”) (citing 42 FR 33534, 33551 (Jun. 30, 1977)). Courts have consistently upheld NHTSA’s implementation of EPCA in this manner. *See, e.g., Competitive Enterprise Institute v. NHTSA*, 956 F. 2d 321, 322 (DC Cir. 1992) (“CEI-II”) (in determining the maximum feasible standard, “NHTSA has always taken passenger safety into account) (citing CEI-I, 901 F.2d at 120 n. 11); *Competitive Enterprise Institute v. NHTSA*, 45 F.3d 481, 482–83 (DC Cir. 1995) (CEI-III) (same); *Center for Biological Diversity v. NHTSA*, 538 F.3d 1172, 1203–04 (9th Cir. 2008) (upholding NHTSA’s analysis of vehicle safety issues associated with weight in connection with the MYs 2008–2011 light truck CAFE rulemaking).

¹⁰⁵⁴ South Coast AQMD, at 2.

relevant data and articulate a satisfactory explanation for its action including a “rational connection between the facts found and the choice made.”¹⁰⁵⁵

Statutory interpretations included in an agency’s rule are subject to the two-step analysis of *Chevron, U.S.A. v. Natural Resources Defense Council*.¹⁰⁵⁶ Under step one, where a statute “has directly spoken to the precise question at issue,” *id.* at 842, the court and the agency “must give effect to the unambiguously expressed intent of Congress.”¹⁰⁵⁷ If the statute is silent or ambiguous regarding the specific question, the court proceeds to step two and asks “whether the agency’s answer is based on a permissible construction of the statute.”¹⁰⁵⁸ The APA also requires that agencies provide notice and comment to the public when proposing regulations,¹⁰⁵⁹ as NHTSA did for the proposal that preceded this final rule.

NHTSA recognizes that this final rule, like the 2020 final rule, is reconsidering standards previously promulgated. NHTSA, like any other Federal agency, is afforded an opportunity to reconsider prior views and, when warranted, to adopt new positions. Indeed, as a matter of good governance, agencies should revisit their positions when appropriate, especially to ensure that their actions and regulations reflect legally sound interpretations of the agency’s authority and remain consistent with the agency’s views and practices. As a matter of law, “an [agency] is entitled to change its interpretation of a statute.”¹⁰⁶⁰ Nonetheless, “[w]hen an [agency] adopts a materially changed interpretation of a statute, it must in addition provide a ‘reasoned analysis’ supporting its decision to revise its interpretation.”¹⁰⁶¹

“Changing policy does not, on its own, trigger an especially ‘demanding burden of justification.’”¹⁰⁶² Providing a reasoned explanation “would ordinarily demand that [the agency]

display awareness that it is changing position.”¹⁰⁶³ Beyond that, however, “[w]hen an agency changes its existing position, it ‘need not always provide a more detailed justification than what would suffice for a new policy created on a blank slate.’”¹⁰⁶⁴ While the agency “must show that there are good reasons for the new policy,” the agency “need not demonstrate to a court’s satisfaction that the reasons for the new policy are *better* than the reasons for the old one.”¹⁰⁶⁵ “[I]t suffices that the new policy is permissible under the statute, that there are good reasons for it, and that the [agency] *believes* it to be better, which the conscious change of course adequately indicates.”¹⁰⁶⁶ For instance, “evolving notions” about the appropriate balance of varying policy considerations constitute sufficiently good reasons for a change in position.¹⁰⁶⁷ Moreover, it is “well within an [agency’s] discretion” to change policy course even when no new facts have arisen: Agencies are permitted to conduct a “reevaluation of which policy would be better in light of the facts,” without “rely[ing] on new facts.”¹⁰⁶⁸

Mr. Kreucher commented that NHTSA did not offer “any new science that would compel a change in the stringency of the CAFE standards . . . , especially one under ‘unusually condensed’ timing. No evidence is presented on technological breakthroughs in support of the proposal[.]. The only thing that changed [is] the Administrator[] of the [agency]. Political ideology is not science. The will of the Administrators is not a reason for changing a rule. Instituting a rule change (or withdrawing a previous rule) because of political ideology is the definition of arbitrary and capricious rulemaking.”¹⁰⁶⁹

NHTSA disagrees that the basis for amending the MY 2024–2026 standards is political ideology. The agency has updated many aspects of the analysis; our thinking about the appropriate balance of various policy considerations

has evolved; and the updated analysis helps to inform the agency about the effects of different regulatory actions. As explained in the NPRM, to be sure, providing “a more detailed justification” is appropriate in some cases. “Sometimes [the agency] must [provide a more detailed justification than what would suffice for a new policy created on a blank slate]—when, for example, its new policy rests upon factual findings that contradict those which underlay its prior policy; or when its prior policy has engendered serious reliance interests that must be taken into account.”¹⁰⁷⁰ This preamble, and the accompanying TSD and FRIA, all provide extensive detail on the agency’s updated analysis, and Section VI.D contains the agency’s explanation of how the agency has considered that analysis and other relevant information in determining that the final CAFE standards are maximum feasible for MY 2024–2026 passenger cars and light trucks.

C. National Environmental Policy Act

As discussed above, EPCA requires the agency to determine the level at which to set CAFE standards for each model year by considering the four factors of technological feasibility, economic practicability, the effect of other motor vehicle standards of the Government on fuel economy, and the need of the United States to conserve energy. The National Environmental Policy Act (NEPA) directs that environmental considerations be integrated into that process.¹⁰⁷¹ To explore the potential environmental consequences of this rulemaking action, the agency prepared a Draft SEIS for the NPRM and a Final SEIS for the final rule.¹⁰⁷² The purpose of an EIS is to “provide full and fair discussion of significant environmental impacts and [to] inform decisionmakers and the public of the reasonable alternatives which would avoid or minimize adverse impacts or enhance the quality of the human environment.”¹⁰⁷³

The agency’s overall EIS-related obligation is to “take a ‘hard look’ at the environmental consequences before

¹⁰⁷⁰ See *Fox Television Stations, Inc.*, 556 U.S. at 515 (2009).

¹⁰⁷¹ NEPA is codified at 42 U.S.C. 4321–47. The Council on Environmental Quality (CEQ) NEPA implementing regulations are codified at 40 CFR parts 1500–1508.

¹⁰⁷² Because this final rule revises CAFE standards established in the 2020 final rule, NHTSA chose to prepare a SEIS to inform that amendment of the MYs 2024–2026 standards. See the SEIS for more details.

¹⁰⁷³ 40 CFR 1502.1.

¹⁰⁵⁵ *Burlington Truck Lines, Inc. v. United States*, 371 U.S. 156, 168 (1962).

¹⁰⁵⁶ 467 U.S. 837 (1984).

¹⁰⁵⁷ *Id.* at 843.

¹⁰⁵⁸ *Id.*

¹⁰⁵⁹ 5 U.S.C. 553.

¹⁰⁶⁰ *Phoenix Hydro Corp. v. FERC*, 775 F.2d 1187, 1191 (DC Cir. 1985).

¹⁰⁶¹ *Alabama Educ. Ass’n v. Chao*, 455 F.3d 386, 392 (DC Cir. 2006) (quoting *Motor Vehicle Mfrs. Ass’n of U.S., Inc. v. State Farm Mut. Auto. Ins. Co.*, 463 U.S. 29, 57 (1983)); see also *Encino Motorcars, LLC v. Navarro*, 136 S.Ct. 2117, 2125 (2016) (“Agencies are free to change their existing policies as long as they provide a reasoned explanation for the change.”) (citations omitted).

¹⁰⁶² See *Mingo Logan Coal Co. v. EPA*, 829 F.3d 710, 718 (DC Cir. 2016) (quoting *Ark Initiative v. Tidwell*, 816 F.3d 119, 127 (DC Cir. 2016)).

¹⁰⁶³ *FCC v. Fox Television Stations, Inc.* 556 U.S. 502, 515 (2009) (emphasis in original) (“An agency may not, for example, depart from a prior policy *sub silentio* or simply disregard rules that are still on the books.”).

¹⁰⁶⁴ *Encino Motorcars, LLC*, 136 S.Ct. at 2125–26 (quoting *Fox Television Stations, Inc.* 556 U.S. at 515).

¹⁰⁶⁵ *Fox Television Stations, Inc.*, 556 U.S. at 515 (emphasis in original).

¹⁰⁶⁶ *Id.* (emphasis in original).

¹⁰⁶⁷ *N. Am.’s Bldg. Trades Unions v. Occupational Safety & Health Admin.*, 878 F.3d 271, 303 (DC Cir. 2017) (quoting the agency’s rule).

¹⁰⁶⁸ *Nat’l Ass’n of Home Builders v. EPA*, 682 F.3d 1032, 1037–38 (DC Cir. 2012).

¹⁰⁶⁹ Walt Kreucher, Docket No. NHTSA–2021–0053–0013, at 14.

taking a major action.”¹⁰⁷⁴ Significantly, “[i]f the adverse environmental effects of the proposed action are adequately identified and evaluated, the agency is not constrained by NEPA from deciding that other values outweigh the environmental costs.”¹⁰⁷⁵ The agency must identify the “environmentally preferable” alternative but need not adopt it.¹⁰⁷⁶ “Congress in enacting NEPA . . . did not require agencies to elevate environmental concerns over other appropriate considerations.”¹⁰⁷⁷ Instead, NEPA requires an agency to develop and consider alternatives to the proposed action in preparing an EIS.¹⁰⁷⁸ The statute and implementing regulations do not command the agency to favor an environmentally preferable course of action, only that it make its decision to proceed with the action after taking a hard look at the potential environmental consequences and consider the relevant factors in making a decision among alternatives.¹⁰⁷⁹

The agency received many comments on the Draft SEIS. Among the comments received, many commenters stated that the Preferred Alternative was not stringent enough and argued that either the environmental benefits of the proposal were (1) insufficient or (2) incorrectly assessed in a variety of ways. Comments regarding the environmental analyses presented in this preamble are addressed in Section VIII.D, while those regarding the Draft SEIS are addressed in Chapter 10 of the Final SEIS.

When preparing an EIS, NEPA requires an agency to compare the potential environmental impacts of its proposed action and a reasonable range of alternatives. In the Draft SEIS, NHTSA analyzed a No-Action Alternative and three action alternatives. In the Final SEIS, the agency analyzed a No-Action Alternative and four action alternatives. The alternatives represent a range of potential actions the agency could take, and they are described more fully in Section IV of this preamble, Chapter 1 of the TSD, and Chapter 2 of the FRIA. The environmental impacts of these alternatives, in turn, represent a range of potential environmental impacts that could result from the agency’s setting maximum feasible fuel economy

standards for passenger cars and light trucks.

To derive the direct and indirect impacts of the action alternatives, the agency compared each action alternative to the No-Action Alternative, which reflects baseline trends that would be expected in the absence of any further regulatory action. More specifically, the No-Action Alternative in the Draft SEIS and Final SEIS assumed that the CAFE standards set in the 2020 final rule for MY 2021–2026 passenger cars and light trucks would remain in effect. In addition, the No-Action Alternative assumes that the MY 2026 SAFE rule standards continue to apply for MY 2027 and beyond, for both NHTSA and EPA. Like all of the Action Alternatives, the No-Action Alternative also includes other legal requirements and automaker commitments that will be in place during the rulemaking time frame, as discussed in more detail in Section IV above: (1) California’s ZEV mandate (and its adoption by 177 states); (2) the “Framework Agreements” between California and BMW, Ford, Honda, VWA, and Volvo, which the agency implemented by including EPA’s baseline GHG standards (*i.e.*, those set in the 2020 final rule) and introducing more stringent GHG target functions for those manufacturers; and (3) the assumption that manufacturers will also make any additional fuel economy improvements estimated to reduce owners’ estimated average fuel outlays during the first 30 months of vehicle operation by more than the estimated increase in new vehicle price. The No-Action Alternative provides a baseline (*i.e.*, an illustration of what would be occurring in the world in the absence of new Federal regulations) against which to compare the environmental impacts of other alternatives presented in the Draft SEIS and Final SEIS.¹⁰⁸⁰

For the Final SEIS, the agency analyzed four action alternatives, Alternatives 1, 2, 2.5, and 3. Alternative 1 would require a 10.5 percent annual increase for MY 2024 over MY 2023 and a 3.26 percent annual average annual fleet-wide increase in fuel economy for both passenger cars and light trucks for

MYs 2025–2026. Alternative 2 would require an 8.0 percent average annual fleet-wide increase in fuel economy for both passenger cars and light trucks for MYs 2024–2026. Alternative 2.5 would require an 8.0 percent average annual fleet-wide increase in fuel economy for both passenger cars and light trucks for MYs 2024 and 2025, and a 10.0 percent average annual fleet-wide increase in fuel economy for both passenger cars and light trucks for MY 2026. Alternative 3 would require a 10.0 percent average annual fleet-wide increase in fuel economy for both passenger cars and light trucks for MYs 2024–2026. The primary differences between the action alternatives considered for the Draft SEIS and the Final SEIS is that the Final SEIS added an alternative, Alternative 2.5. Both of the ranges of action alternatives, as well as the No-Action Alternative, in the Draft SEIS and Final SEIS encompassed a spectrum of possible standards the agency could determine was maximum feasible based on the different ways the agency could weigh EPCA’s four statutory factors. Throughout the Final SEIS, estimated impacts were shown for all of these action alternatives, as well as for the No-Action Alternative. For a more detailed discussion of the environmental impacts associated with the alternatives, see Chapters 3–8 of the Final SEIS, as well as Section VIII.D of this preamble.

The agency’s Final SEIS describes potential environmental impacts to a variety of resources, including fuel and energy use, air quality, climate, land use and development, hazardous materials and regulated wastes, historical and cultural resources, noise, and environmental justice. The Final SEIS also describes how climate change resulting from global greenhouse gas emissions (including CO₂ emissions attributable to the U.S. light-duty transportation sector under the alternatives considered) could affect certain key natural and human resources. Resource areas are assessed qualitatively and quantitatively, as appropriate, in the Final SEIS, and the findings of that analysis are summarized here.¹⁰⁸¹

¹⁰⁸¹ The impacts described in this section come from NHTSA’s Final SEIS, which is being publicly issued simultaneously with this Final Rule. As described above, the SEIS is based on “unconstrained” modeling rather than “standard setting” modeling. NHTSA conducts modeling both ways in order to reflect the various statutory requirements of EPCA/EISA and NEPA. The preamble employs the “standard setting” modeling in order to aid the decision-maker in avoiding consideration of the prohibited items in 49 U.S.C. 32902(h) in determining maximum feasible standards, but as a result, the impacts reported here

¹⁰⁷⁴ *Baltimore Gas & Elec. Co. v. Natural Resources Defense Council, Inc.*, 462 U.S. 87, 97 (1983).

¹⁰⁷⁵ *Robertson v. Methow Valley Citizens Council*, 490 U.S. 332, 350 (1989).

¹⁰⁷⁶ 40 CFR 1505.2(b).

¹⁰⁷⁷ *Baltimore Gas*, 462 U.S. at 97.

¹⁰⁷⁸ 42 U.S.C. 4332(2)(C)(iii).

¹⁰⁷⁹ 40 CFR 1505.2(b).

¹⁰⁸⁰ See 40 CFR 1502.2(e), 1502.14(d). CEQ has explained that “[T]he regulations require the analysis of the No-Action Alternative even if the agency is under a court order or legislative command to act. This analysis provides a benchmark, enabling decision makers to compare the magnitude of environmental effects of the action alternatives [See 40 CFR 1502.14(c)]. . . . Inclusion of such an analysis in the EIS is necessary to inform Congress, the public, and the President as intended by NEPA. [See 40 CFR 1500.1(a).]” Forty Most Asked Questions Concerning CEQ’s National Environmental Policy Act Regulations, 46 FR 18026 (Mar. 23, 1981).

As the stringency of the alternatives increases, total U.S. passenger car and light truck fuel consumption for the period of 2020 to 2050 decreases. Total light-duty vehicle fuel consumption from 2020 to 2050 under the No-Action Alternative is projected to be 3,559 billion gasoline gallon equivalents (GGE). Light-duty vehicle fuel consumption from 2020 to 2050 under the action alternatives is projected to range from 3,471 billion GGE under Alternative 1 to 3,321 billion GGE under Alternative 3. Under Alternative 2, light-duty vehicle fuel consumption from 2020 to 2050 is projected to be 3,391 billion GGE. Under Alternative 2.5, light-duty vehicle fuel consumption from 2020 to 2050 is projected to be 3,371 billion GGE. All of the action alternatives would decrease fuel consumption compared to the No-Action Alternative, with fuel consumption decreases that range from 88 billion GGE under Alternative 1 to 238 billion GGE under Alternative 3.

The relationship between stringency and criteria and air toxics pollutant emissions is less straightforward, reflecting the complex interactions among the tailpipe emissions rates of the various vehicle types (passenger cars and light trucks, ICE vehicles and Evs, older and newer vehicles, etc.), the technologies assumed to be incorporated by manufacturers in response to CAFE standards, upstream emissions rates, the relative proportions of gasoline, diesel, and electricity in total fuel consumption, and changes in VMT from the rebound effect. In general, emissions of criteria and toxic air pollutants increase very slightly in the short term, and then decrease dramatically in the longer term, across all action alternatives, with some exceptions. In addition, the action alternatives would result in decreased incidence of PM_{2.5}-related health impacts in most years and alternatives due to the emissions decreases. Decreases in adverse health outcomes include decreased incidences of premature mortality, acute bronchitis, respiratory emergency room visits, and work-loss days.

The air quality analysis in the Final SEIS identified the following impacts on criteria air pollutants:

For CO, NO_x, and SO₂ in 2025, emissions increase slightly under the action alternatives compared to the No-Action Alternative. The emission

increases generally get larger (although they are still small) from Alternative 1 through Alternative 3 (the most stringent alternative in terms of required miles per gallon). This temporary increase is largely due to new vehicle prices increasing in the short-term, which slightly slows new-vehicle sales and encourages consumers to buy used vehicles instead or retain existing vehicles for longer. As the analysis timeframe progresses, the new, higher fuel-economy vehicles become used vehicles, and the impacts of the standards change direction. In 2025, across all criteria pollutants and action alternatives, the smallest increase in emissions is .03 percent for NO_x under Alternative 1; The largest increase is 0.6 percent and occurs for SO₂ under Alternative 3. We underscore that these are fractions of a single percent.

In 2035 and 2050, emissions of CO, NO_x, PM_{2.5}, and VOCs decrease under the action alternatives compared to the No-Action Alternative with the more stringent alternatives having the largest decreases). SO₂ emissions generally increase under the action alternatives compared to the No-Action Alternative (except in 2035 under Alternative 1), with the more stringent alternatives having the largest increases. SO₂ increases are largely due to higher upstream emissions associated with electricity use by greater numbers of electrified vehicles being produced in response to the standards. In 2035 and 2050, across all criteria pollutants and action alternatives, the smallest decrease in emissions is 0.1 percent and occurs for CO and SO₂ under Alternative 1; the largest decrease is 12.0 percent and occurs for VOCs under Alternative 3. The smallest increase in emissions is 0.03 percent and occurs for NO_x under Alternative 1; the largest increase is 7.4 percent and occurs for SO₂ under Alternative 3.

The air quality analysis identified the following impacts on toxic air pollutants:

Under each action alternative in 2025 compared to the No-Action Alternative, increases in emissions would occur for acetaldehyde, acrolein, benzene, and 1,3-butadiene by up to about 0.2 percent, and for formaldehyde by 0.1 percent. DPM emissions would decrease by as much as 0.7 percent. For 2025, the largest relative increases in emissions would occur for 1,3-butadiene, for which emissions would increase by as much as 0.23 percent. Percentage increases in emissions of acetaldehyde, acrolein, and formaldehyde would be lower.

Under each action alternative in 2035 and 2050 compared to the No-Action

Alternative, decreases in emissions would occur for all toxic air pollutants with the more stringent alternatives having the largest decreases. The largest relative decreases in emissions would occur for formaldehyde, for which emissions would decrease by as much as 10.3 percent. Percentage decreases in emissions of acetaldehyde, acrolein, benzene, 1,3-butadiene, and DPM would be less.

The air quality analysis identified the following health impacts:

In 2025, all action alternatives would result in decreases in adverse health impacts (mortality, acute bronchitis, respiratory emergency room visits, and other health effects) nationwide compared to the No-Action Alternative, primarily as a result of decreases in emissions of PM_{2.5}. Decreases in adverse health impacts would be largest for Alternative 1, smaller for Alternative 3, still smaller for Alternative 2, and smallest for Alternative 2.5 relative to the No-Action Alternative. However, the differences among the action alternatives are small. These decreases result from projected decreases in emissions of PM_{2.5} under all action alternatives, which is in turn attributable to shifts in modeled technology adoption from the baseline and to where the rebound effect would be offset by upstream emissions reductions due to decreases in fuel usage. Again, in the short-term, these slight changes in health impacts are projected under the action alternatives as the result of increases in the prices of new vehicles slightly delaying sales of new vehicles and encouraging more VMT in older vehicles instead, but this trend shifts over time as higher fuel-economy new vehicles become used vehicles and older vehicles are removed from the fleet.

In 2035 and 2050, all action alternatives would result in decreased adverse health impacts nationwide compared to the No-Action Alternative as a result of general decreases in emissions of NO_x and PM_{2.5}. The decreases in adverse health impacts get larger from Alternative 1 to Alternative 3 in 2035 and 2050, except that for some health impacts in 2035 and 2050 the decreases are smaller for Alternative 2.5 than for Alternative 2. These decreases reflect the generally increasing stringency of the action alternatives as they become implemented.

The alternatives would have the following impacts related to Climate:

In terms of climate effects, all action alternatives would decrease U.S. passenger car and light truck fuel consumption compared with the No-Action Alternative, resulting in

may differ from those reported elsewhere in this preamble. However, NHTSA considers the impacts reported in the SEIS, in addition to the other information presented in this preamble, the TSD, and the FRIA, as part of its decision-making process.

reductions in the anticipated increases in global CO₂ concentrations, temperature, precipitation, and sea level, and increases in ocean pH that would otherwise occur. The impacts of the action alternatives on global mean surface temperature, precipitation, sea level, and ocean pH would be small in relation to global emissions trajectories. Although these effects are small, they occur on a global scale and are long lasting; therefore, in aggregate, they can have large consequences for health and welfare and can make an important contribution to reducing the risks associated with climate change.

The alternatives would have the following impacts related to GHG emissions:

Passenger cars and light trucks are projected to emit 89,200 million metric tons of carbon dioxide (MMTCO₂) from 2021 through 2100 under the No-Action Alternative. Alternative 1 and Alternative 2 would decrease these emissions by 4 and 7 percent through 2100. Alternative 3 would decrease these emissions by 10 percent through 2100. Emissions would be highest under the No-Action Alternative, and emission reductions would increase from Alternative 1 to Alternative 3. All CO₂ emissions estimates associated with the Proposed Action and alternatives include upstream emissions.

Compared with total projected CO₂ emissions of 967 MMTCO₂ from all passenger cars and light trucks under the No-Action Alternative in the year 2100, the action alternatives are expected to decrease CO₂ emissions from passenger cars and light trucks in the year 2100 5 percent under Alternative 1, 9 percent under Alternative 2, 10 percent under Alternative 2.5, and 12 percent under Alternative 3.

The emission reductions in 2025 compared with emissions under the No-Action Alternative are approximately equivalent to the annual emissions from 1,143,017 vehicles under Alternative 1, 1,613,007 vehicles under Alternative 2, 1,763,066 vehicles under Alternative 2.5, and 2,379,681 vehicles under Alternative 3. For scale, a total of 253,949,461 passenger cars and light truck vehicles are projected to be on the road in 2025 under the No-Action Alternative.

The alternatives would have the following impacts related to Carbon Dioxide Concentration, Global Mean Surface Temperature, Sea Level, Precipitation, and Ocean pH:

CO₂ emissions affect the concentration of CO₂ in the atmosphere, which in turn affects global temperature, sea level, precipitation,

and ocean pH. For the analysis of direct and indirect impacts, the agency used the Global Change Assessment Model Reference (GCAMReference) scenario and SSP3–7.0 scenario to represent the Reference Case emissions scenario (*i.e.*, future global emissions assuming no comprehensive global actions to mitigate GHG emissions). NHTSA selected the GCAMReference and SSP3–7.0 scenarios for their incorporation of a comprehensive suite of GHG and pollutant gas emissions, including carbonaceous aerosols and a global context of emissions with a full suite of GHGs and ozone precursors

Estimated CO₂ concentrations in the atmosphere for 2100 under the GCAMReference scenario would range from 788.33 ppm under Alternative 3 to approximately 789.11 ppm under the No-Action Alternative, indicating a maximum atmospheric CO₂ decrease of approximately 0.78 ppm compared to the No-Action Alternative. Atmospheric CO₂ concentration under Alternative 1 would decrease by 0.31 ppm compared with the No-Action Alternative. The CO₂ concentrations under the SSP3–7.0 emissions scenario in 2100 would range from 799.57 ppm under Alternative 3 to approximately 800.39 ppm under the No-Action Alternative, indicating a maximum atmospheric CO₂ decrease of approximately 0.82 ppm compared to the No-Action Alternative. Alternative 1 would decrease by 0.30 ppm compared with the No-Action Alternative.

Under the GCAMReference scenario, global mean surface temperature is projected to increase by approximately 3.48°C (6.27 °F) under the No-Action Alternative by 2100. Implementing the most stringent alternative (Alternative 3) would decrease this projected temperature rise by 0.003°C (0.006 °F), while implementing Alternative 1 would decrease projected temperature rise by 0.001°C (0.002 °F). Under the SSP3–7.0 emissions scenario, global mean surface temperature is projected to increase by approximately 3.56°C (6.41 °F) under the No-Action Alternative by 2100. Implementing the most stringent alternative (Alternative 3) would decrease this projected temperature rise by 0.004°C (0.007 °F), while implementing Alternative 1 would decrease projected temperature rise by 0.001°C (0.002 °F).

Projected sea-level rise in 2100 under the GCAMReference scenario ranges from a high of 76.28 centimeters (30.03 inches) under the No-Action Alternative to a low of 76.22 centimeters (30.01 inches) under Alternative 3. Alternative 3 would result in a decrease in sea-level rise equal to 0.07 centimeter (0.03 inch) by 2100 compared with the level

projected under the No-Action Alternative compared to a decrease under Alternative 1 of 0.03 centimeter (0.01 inch) compared with the No-Action Alternative. Projected sea-level rise in 2100 under the SSP3–7.0 scenario ranges from a high of 78.53 centimeters (30.92 inches) under the No-Action Alternative to a low of 78.43 centimeters (30.88 inches) under Alternative 3. Alternative 3 would result in a decrease in sea-level rise equal to 0.10 centimeter (0.04 inch) by 2100 compared with the level projected under the No-Action Alternative. Alternative 1 would result in a decrease of 0.02 centimeter (0.008 inch) compared with the No-Action Alternative.

Under the GCAMReference scenario, global mean precipitation is anticipated to increase by 5.85 percent by 2100 under the No-Action Alternative. Under the action alternatives, this increase in precipitation would be reduced by 0.00 to 0.01 percent. Under the SSP3–7.0 scenario, global mean precipitation is anticipated to increase by 6.09 percent by 2100 under the No-Action Alternative. Under the action alternatives, this increase in precipitation would be reduced by 0.00 to 0.01 percent.

Ocean pH in 2100 under the GCAMReference scenario is anticipated to be 8.2180 under Alternative 3, about 0.0004 more than the No-Action Alternative. Under Alternative 1, ocean pH in 2100 would be 8.2178, or 0.0002 more than the No-Action Alternative. Ocean pH in 2100 under the SSP3–7.0 scenario is anticipated to be 8.2123 under Alternative 3, about 0.0004 more than the No-Action Alternative. Under Alternative 1, ocean pH in 2100 would be 8.2120, or 0.0002 more than the No-Action Alternative.

The action alternatives would reduce the impacts of climate change that would otherwise occur under the No-Action Alternative. Although the projected reductions in CO₂ and climate effects are small compared with total projected future climate change, they are quantifiable and directionally consistent and would represent an important contribution to reducing the risks associated with climate change.

The alternatives would have the following impacts related to Health, Societal, and Environmental Impacts of Climate Change:

The Proposed Action and alternatives would reduce the impacts of climate change that would otherwise occur under the No-Action Alternative. The magnitude of the changes in climate effects that would be produced by the most stringent action alternative

(Alternative 3) using the three degree sensitivity analysis by the year 2100 is between 0.73 ppm and 0.80 ppm lower concentration of CO₂, three thousandths of a degree increase in temperature rise, a small percentage change in the rate of precipitation increase, between 0.10 and 0.11 centimeter (0.04 inch) decrease in sea-level rise, and an increase of between 0.0004 and 0.0005 in ocean pH. Although the projected reductions in CO₂ and climate effects are small compared with total projected future climate change, they are quantifiable, directionally consistent, and would represent an important contribution to reducing the risks associated with climate change.

Although the agency does quantify the changes in monetized damages that can be attributable to each action alternative, many specific impacts of climate change on health, society, and the environment cannot be estimated quantitatively. Therefore, the agency provides a qualitative discussion of these impacts by presenting the findings of peer-reviewed panel reports including those from IPCC, the Global Change Research Program, the Climate Change Science Program, the National Research Council, and the Arctic Council, among others. While the action alternatives would decrease growth in GHG emissions and reduce the impact of climate change across resources relative to the No-Action Alternative, they would not themselves prevent climate change and associated impacts. Long-term climate change impacts identified in the scientific literature are briefly summarized below, and vary regionally, including in scope, intensity, and directionality (particularly for precipitation). While it is difficult to attribute any particular impact to emissions that could result from this final rule, the following impacts are likely to be beneficially affected to some degree by reduced emissions from the action alternatives:

- Impacts on freshwater resources are projected to include changes in rainfall and streamflow patterns, warming temperatures and reduced snowpack, changes in water availability paired with increasing water demand for irrigation and other needs, and decreased water quality from increased algal blooms. Inland flood risk is projected to increase in response to increasing intensity of precipitation events, drought, changes in sediment transport, and changes in snowpack and the timing of snowmelt.

- Impacts on terrestrial and freshwater ecosystems are projected to include shifts in the range and seasonal migration patterns of species, relative

timing of species' life-cycle events, potential extinction of sensitive species that are unable to adapt to changing conditions, increases in the occurrence of forest fires and pest infestations, and changes in habitat productivity due to increased atmospheric concentrations of CO₂.

- Impacts on ocean systems, coastal regions, and low-lying areas are projected to include the loss of coastal areas due to inundation, submersion, or erosion from sea-level rise and storm surge, with increased vulnerability of the built environment and associated economies. Changes in key habitats (e.g., increased temperatures, decreased oxygen, decreased ocean pH, increased salinization) and reductions in key habitats (e.g., coral reefs) are projected to affect the distribution, abundance, and productivity of many marine species.

- Impacts on food, fiber, and forestry are projected to include increasing tree mortality, forest ecosystem vulnerability, productivity losses in crops and livestock, and changes in the nutritional quality of pastures and grazing lands in response to fire, insect infestations, increases in weeds, drought, disease outbreaks, or extreme weather events. Increased concentrations of CO₂ in the atmosphere are projected to also stimulate plant growth to some degree, a phenomenon known as the CO₂ fertilization effect, but the impact varies by species and location. Many marine fish species are projected to migrate to deeper or colder water in response to rising ocean temperatures, and global potential fish catches could decrease. Impacts on food and agriculture, including yields, food processing, storage, and transportation, are projected to affect food prices, socioeconomic conditions, and food security globally.

- Impacts on rural and urban areas are projected to affect water and energy supplies, wastewater and stormwater systems, transportation, telecommunications, provision of social services, incomes (especially agricultural), air quality, and safety. The impacts are projected to be greater for vulnerable populations such as lower-income populations, historically underserved populations, some communities of color and tribal and Indigenous communities, the elderly, those with existing health conditions, and young children.

- Impacts on human health are projected to include increases in mortality and morbidity due to excessive heat and other extreme weather events, increases in respiratory conditions due to poor air quality and

aeroallergens, increases in water and food-borne diseases, increases in mental health issues, and changes in the seasonal patterns and range of vector-borne diseases. The most disadvantaged groups such as children, the elderly, the sick, those experiencing discrimination, historically underserved populations, some communities of color and tribal and Indigenous communities, and low-income populations are especially vulnerable and are projected to experience disproportionate health impacts.

- Impacts on human security are projected to include increased threats in response to adversely affected livelihoods, compromised cultures, increased or restricted migration, increased risk of armed conflicts, reduction in adequate essential services such as water and energy, and increased geopolitical rivalry.

In addition to the individual impacts of climate change on various sectors, compound events may occur more frequently. Compound events consist of two or more extreme weather events occurring simultaneously or in sequence when underlying conditions associated with an initial event amplify subsequent events and, in turn, lead to more extreme impacts. To the extent the action alternatives would result in reductions in projected increases in global CO₂ concentrations, this rulemaking would contribute to reducing the risk of compound events.

In most cases, NHTSA presents the findings of a literature review of scientific studies in the Final SEIS, such as in Chapter 6, where NHTSA provides a literature synthesis focusing on existing credible scientific information to evaluate the most significant lifecycle environmental impacts from some of the fuels, materials, and technologies that may be used to comply with the alternatives. In Chapter 7, NHTSA discusses land use and development, hazardous materials and regulated waste, historical and cultural resources, noise, and environmental justice. Finally, in Chapter 8, NHTSA discusses cumulative impacts related to energy, air quality, and climate change, and provides a literature synthesis of the impacts on key natural and human resources of changes in climate change variables. In these chapters, NHTSA concludes that impacts would vary between the action alternatives.

Based on the foregoing, NHTSA concludes from the Final SEIS that Alternative 3 is the overall environmentally preferable alternative because, assuming full compliance were achieved regardless of the agency's assessment of the costs to industry and

society, it would result in the largest reductions in fuel use and CO₂ emissions among the alternatives considered. In addition, Alternative 3 would result in the lowest overall emissions levels over the long term of criteria air pollutants and of the toxic air pollutants studied by NHTSA. Impacts on other resources (especially those described qualitatively in the Final SEIS) would be proportional to the impacts on fuel use and emissions, as further described in the Final SEIS, with Alternative 3 expected to have the fewest negative impacts. Although the CEQ regulations require NHTSA to identify the environmentally preferable alternative,¹⁰⁸² the agency need not adopt it, as described above. The following section explains how NHTSA balanced the relevant factors to determine which alternative represented the maximum feasible standards, including why NHTSA does not believe that the environmentally preferable alternative is maximum feasible.

NHTSA has considered the discussion above and the Final SEIS carefully in arriving at its conclusion that Alternative 2.5 is maximum feasible, as discussed below. The following section (Section VI.D) explains how NHTSA balanced the relevant factors to determine which alternative represented the maximum feasible standards.

D. Evaluating the EPCA Factors and Other Considerations To Arrive at the Final Standards

Despite only two years having passed since the 2020 final rule, enough has changed in the United States and in the world that revisiting the CAFE standards for MYs 2024–2026 is reasonable and appropriate. The agency has determined that the standards should be revised to emphasize the purpose of the program: Energy conservation. NHTSA continues to believe that strong fuel economy standards function as an important insurance policy against oil price volatility, particularly to protect consumers even as the U.S. has improved its energy independence over time. The only way to continue to insulate consumers and the U.S. economy further against the negative effects of swings in oil prices is to continue to improve fleet fuel economy and take other steps to reduce the oil-intensity of the economy. Moreover, as climate change progresses, the U.S. may face new energy-related security risks if climate effects exacerbate geopolitical tensions and destabilization. Thus, mitigating climate effects by increasing

fuel economy standards, as all of the action alternatives considered in this final rule would do, can also potentially improve U.S. security. There are extremely important energy security benefits associated with raising CAFE stringency that are not discussed in TSD Chapter 6.2.4, and which are difficult to quantify, but have weighed heavily for NHTSA in determining the maximum feasible standards in this final rule.

Additionally, nearly all auto manufacturers have announced forthcoming advanced technology, high-fuel-economy vehicle models, and made strong public commitments that mirror the goals of the Administration, with those announcements continuing as the economy recovers from the global coronavirus pandemic, even despite slow-to-resolve supply chain challenges. Five major manufacturers voluntarily bound themselves to stricter GHG national-level requirements as part of the California Framework Agreements, which were finalized in fall 2020. Many, though not all, of the technologies that automakers will use to comply with those agreements will also improve fuel economy. Importantly, NHTSA's own updated analysis of technological feasibility and cost indicates that significant improvements in fuel economy relative to the existing standards are feasible and economically practicable. Some facts on the ground remain similar to what was before NHTSA in the prior analysis—gas prices have risen recently but remain forecasted to stay relatively low in the mid- to longer-term according to AEO 2021,¹⁰⁸³ for example, and light-duty vehicle sales since 2020 have struggled to recover from the effects of the pandemic. The vehicles that *did* sell have tended to be, on average, larger, heavier, and more powerful, all factors which increase fuel consumption. Yet overall fleet fuel economy still achieved a record high according to the 2021 EPA Automotive Trends Report—thus, again, enough has changed that a rebalancing of the EPCA factors is appropriate for MYs 2024–2026. South Coast AQMD commented that “NHTSA . . . should be forthright that the balancing of statutory factors is changed not merely because of new facts, but because the SAFE rule took an unprecedented approach of elevating non-statutory factors above Congress' express directives and overriding

purpose. . . .”¹⁰⁸⁴ NHTSA agrees that the agency's current determination of what CAFE standards are maximum feasible for MYs 2024–2026 is based on a combination of changed facts and evolved legal interpretations—again, that a rebalancing of the factors is in order. As discussed in Section VI.B, agencies are entitled to change their minds, and the record contained in this preamble and the accompanying rulemaking documents provides extensive evidence of why the agency is making this new determination.

NHTSA believes, as we will explain in more detail below, that Alternative 2.5 is the maximum feasible alternative that manufacturers can achieve for MYs 2024–2026, based on its significant fuel savings benefits to consumers and its environmental and energy security benefits relative to all other alternatives except Alternative 3. Although Alternative 3 would provide greater fuel savings benefits, NHTSA estimates that Alternative 3 would result in a large average per-vehicle cost increase, which for many automakers could exceed \$2,000, compared to the price of vehicles under Alternative 2.5. In contrast to Alternative 3, and that it comes at a cost we believe the market can bear. While Alternative 1 produces higher net benefits, it also continues to allow fuel consumption and accompanying disbenefits that could have been avoided in a cost-beneficial manner. And while Alternative 3 achieves greater reductions in fuel consumption than Alternative 2, it shows lower net benefits under a 7 percent discount rate. Alternative 3 also, as detailed above, adds technology costs of over \$2,000 per vehicle for more manufacturers as compared to the baseline, while Alternative 2.5 has somewhat lower costs and greater lead time for the largest increase in standards for MY 2026. Regardless of net benefits, NHTSA would still conclude that Alternative 2.5 is economically practicable, based on per-vehicle costs, technology levels estimated to be required to meet the standards, and the slight additional lead time provided as compared to Alternative 3.

Additionally, these standards represent some of the largest year over year increases in CAFE stringency that NHTSA has ever required, so we believe that providing maximum lead time for the biggest increase of 10 percent for MY 2026 is reasonable and appropriate, particularly given the ongoing rapid changes in the auto industry. Choosing Alternative 3 would require industry to

¹⁰⁸³ Even AEO 2022 continues to reflect gasoline retail prices that are well below \$4/gallon through 2050. See https://www.eia.gov/outlooks/aeo/pdf/AEO2022_ChartLibrary_Petroleum.pdf (accessed: Mar. 24, 2022).

¹⁰⁸⁴ South Coast AQMD, Docket No. NHTSA–2021–0053–1477, at 1.

¹⁰⁸² 40 CFR 1505.2(b).

ramp up even faster, and thus provide less lead time, with consequences for economic practicability. With relatively small estimated sales effects and actually positive estimated effects on employment, we are confident that Alternative 2.5 is feasible, and that industry can meet these standards.

In re-evaluating all of the factors that NHTSA considers in determining maximum feasible CAFE standards, the agency was compelled to balance what we believe is a credible case for choosing Alternative 3 as opposed to Alternative 2.5. In doing so, NHTSA must balance the four statutory factors. Alternative 2.5 and Alternative 3 each produce significant reductions in fuel use, and while Alternative 3 is estimated to result in more savings, it could require significant additional technology application. Alternative 3 also appears to be slightly beyond the level of economic practicability for the model years addressed by this rule, when considering per-vehicle costs, technology application rates, and lead time. Even though Alternative 3 maximizes energy conservation, and NHTSA believes it is technologically feasible, economic practicability tips the balance for the agency to Alternative 2.5. Alternative 2.5 is an ambitious but achievable set of standards that NHTSA has concluded represents the right balancing for MYs 2024–2026—it is technologically feasible; it continues to push fuel economy improvements, bolstering the industry's trajectory toward higher future standards by keeping stringency high in the mid-term. It meets the need of the U.S. to conserve energy, creating important (if unquantifiable) energy security benefits, but in our estimation, not beyond the point of economic practicability; and we believe that it is complementary to other motor vehicle standards of the Government. For these reasons, NHTSA concludes that Alternative 2.5 is maximum feasible for MYs 2024–2026.

NHTSA notes that the issues raised by commenters and with which the agency is grappling have become more intertwined over time. Increasingly, the issues do not parse neatly into the separate considerations that Congress directs NHTSA to evaluate in determining what CAFE standards are maximum feasible. Factors that Congress directs NHTSA *not* to consider are, in many ways, also intertwined with the factors that NHTSA *must* consider. Yet NHTSA is still required to set CAFE standards for cars and trucks, for each model year, at the maximum feasible level, and if the evidence suggests that more stringent standards are maximum feasible, then EPCA's

overarching purpose of energy conservation must guide us. The discussion below seeks to untangle the issues so that the statutory factors and their relationship to each other can be evaluated, while still avoiding the prohibited considerations, while still being aware of and informed by reality.

In the 2020 final rule, NHTSA interpreted the need of the U.S. to conserve energy as less important than in previous rulemakings. This was in part because of structural changes in global oil markets as a result of shale oil drilling in the U.S., but also because in the context of environmental effects, NHTSA narrowly interpreted EPCA/EISA as not requiring the agency to “single-mindedly address carbon emissions at the expense of all other considerations.”¹⁰⁸⁵ Focusing heavily on the “very small” “impacts on global mean surface temperature resulting from this action,” NHTSA concluded then that “[t]aking climate change into account elevates the importance of the ‘need of the United States to conserve energy’ criterion in NHTSA’s balancing,” and stated that, “[h]owever, in light of the limits in what the agency can achieve, the potential offsetting impacts to the environment, and the statutory requirement to consider other factors, the impacts of carbon emissions alone cannot drive the outcome of NHTSA’s decision-making.”¹⁰⁸⁶

One of those other factors was consumer demand for vehicles with higher fuel economy levels, which is relevant to the economic practicability of potential CAFE standards—if industry's response to standards is to make vehicles that consumers refuse to purchase, then the standards may not be economically practicable.¹⁰⁸⁷ In the 2020 final rule, NHTSA expressed concern that low gasoline prices and apparent consumer preferences for larger, heavier, more powerful vehicles would make it exceedingly difficult for manufacturers to achieve higher standards without negative consequences to sales and jobs, and would cause consumer welfare losses. Since then, however, more and more manufacturers are announcing more and more vehicle models with advanced engines and varying levels of electrification. In the NPRM, NHTSA

argued that it is reasonable to conclude that manufacturers (who are all for-profit companies) would not be announcing plans to offer these types of vehicles if they did not expect to be able to sell them,¹⁰⁸⁸ and thus that manufacturers are more sanguine about consumer demand for fuel efficiency going forward than they have been previously.

Additionally, NHTSA no longer believes that it is reasonable or appropriate to focus only on “avoiding waste” in evaluating the need of the U.S. to conserve energy. EPCA's overarching purpose is energy conservation. The need of the U.S. to conserve energy may be reasonably interpreted as continuing to push the balancing toward greater stringency. Recent events have further reinforced the enduring importance of reducing Americans' exposure to volatility in globalized oil markets through improved fuel economy. There are extremely important energy security benefits associated with raising CAFE stringency that are not discussed in TSD Chapter 6.2.4, and which are difficult to quantify, but have weighed heavily for NHTSA in determining the maximum feasible standards in this final rule.

The following text will walk through the four statutory factors in more detail and discuss NHTSA's decision-making process more thoroughly. To be clear at the outset, however, the fundamental balancing of factors for this final rule is different from the 2020 final rule because NHTSA reconsidered how to balance its relevant statutory obligations under EPCA, and interprets the need of the U.S. to conserve energy as weighing more heavily than it did at the time of the 2020 final rule. As noted earlier in this preamble NHTSA, like any other Federal agency, is afforded an opportunity to reconsider prior views and, when warranted, to adopt new positions. The evidence also suggests that higher standards are economically practicable, as well as being technologically feasible and feasible in the context of (and complementary of) the effects of other motor vehicle standards of the Government on fuel economy. In order to be maximum feasible in the rulemaking time frame, CAFE standards need to be set at levels that reflect all of that evidence.

¹⁰⁸⁵ 85 FR 25173 (Apr. 30, 2020).

¹⁰⁸⁶ *Id.*

¹⁰⁸⁷ Mr. Douglas commented that “[w]hen automakers argue that they cannot feasibly increase fuel economy any further, what they are really saying is that they cannot possibly increase fuel economy any further while continuing to produce the vehicles that consumers demand.” Peter Douglas, Docket No. NHTSA–2021–0053–0085, at 20.

¹⁰⁸⁸ To the extent that manufacturers are offering these vehicles in response to expected regulations, NHTSA still believes that they would not do so before any required standards had been announced if they believed the vehicles were unsaleable or unmanageably detrimental to profits. Vehicle manufacturers are sophisticated corporate entities well able to communicate their views to regulatory agencies.

Again, for context and for the reader's reference, here are the regulatory alternatives among which NHTSA has

chosen maximum feasible CAFE standards for MYs 2024–2026, representing different annual rates of

stringency increase over the required levels in MY 2023:

Table VI-10 – Annual Rate of Increase in Final CAFE Stringency for Each Model Year from 2024 to 2026

Regulatory Alternative	Year-Over-Year Stringency Increases (Passenger Cars)			Year-Over-Year Stringency Increases (Light Trucks)		
	2024	2025	2026	2024	2025	2026
Alternative 0 (No Action)	1.5%	1.5%	1.5%	1.5%	1.5%	1.5%
Alternative 1	9.14%	3.26%	3.26%	11.02%	3.26%	3.26%
Alternative 2	8%	8%	8%	8%	8%	8%
Alternative 2.5 (Preferred)	8%	8%	10%	8%	8%	10%
Alternative 3	10%	10%	10%	10%	10%	10%

In evaluating the statutory factors to determine maximum feasible standards, we may begin with the need of the U.S. to conserve energy, which is being considered more holistically in this final rule as compared to in the 2020 final rule. According to the analysis presented in Section V and in the accompanying FRIA and Final SEIS, Alternative 3 would save consumers the most in fuel costs, and would achieve the greatest reductions in climate change-causing CO₂ emissions. Alternative 3 would also maximize fuel consumption reductions, better protecting consumers from international oil market instability and price spikes. Alternative 2.5 saves somewhat less fuel (and thus, saves consumers somewhat less on fuel costs and reduces CO₂ emissions by somewhat less), but still saves more fuel (and thus fuel cost and CO₂ emissions) than Alternatives 1 and 2. For now, gasoline is still the dominant fuel used in light-duty transportation. As such, consumers, and the economy more broadly, are subject to fluctuations in gasoline price that impact the cost of travel and, consequently, the demand for mobility. Vehicles are long-lived assets and the long-term price uncertainty and volatility of petroleum still represents a risk to consumers. By increasing the fuel economy of vehicles in the marketplace, more stringent CAFE standards better insulate consumers against these risks over longer periods of time, even when accounting for the increased upfront technology costs. Fuel economy improvements that reduce demand for oil are a more effective hedging strategy against price volatility than increasing U.S. energy production, because

gasoline prices are at this time linked to global oil prices. Continuing to reduce the amount of money consumers spend on vehicle fuel thus remains an important consideration for the need of the U.S. to conserve energy.

As discussed in Section VI.A, many commenters agreed that Alternative 3 likely best met the need of the U.S. to conserve energy, because it maximized fuel conservation, with attendant energy security benefits from reduced petroleum use, more fuel savings for consumers, and the most positive impacts on the climate. Tens of thousands of commenters thus urged NHTSA to choose Alternative 3.¹⁰⁸⁹ Commenters arguing that Alternative 3 was maximum feasible and also that compliance flexibilities should be curtailed (in order to maximize real-world fuel savings and emissions reductions) included the Climate Group,¹⁰⁹⁰ ELPC,¹⁰⁹¹ American Lung Mid-Atlantic,¹⁰⁹² Sierra Club,¹⁰⁹³ UCS,¹⁰⁹⁴ SELC,¹⁰⁹⁵ Zero Emission

Transportation Association (ZETA),¹⁰⁹⁶ ACEEE,¹⁰⁹⁷ Great Lakes and Midwest Environmental Organizations,¹⁰⁹⁸ National Parks Conservation Association,¹⁰⁹⁹ roughly 17,000 citizen-members of UCS,¹¹⁰⁰ and 24,700 citizens who signed a petition from Consumer Reports.¹¹⁰¹ NRDC submitted over 27,000 letters from citizen-members asking NHTSA to set standards at least as stringent as EPA's Alternative 2 and to reduce compliance flexibilities, to "put us on the road to the goal of reaching 100 [percent] net-zero vehicle sales by 2035."¹¹⁰² Sierra Club members also submitted over 4,000 letters asking NHTSA to set stringent fuel economy standards.¹¹⁰³

Other commenters focused on the need to *maximize* fuel savings because Congress directs NHTSA to set *maximum feasible* CAFE standards. California Attorney General et al. stated that "Congress' purpose in drafting this language—and specifically, in requiring NHTSA to establish 'maximum feasible' standards—is clear. Congress intended the agency to conserve fuel, and thereby save consumers money, insulate the

¹⁰⁸⁹ See, e.g., CFA, Docket No. NHTSA–2021–0053–1482–A1, at 1; Peter Douglas, Docket No. NHTSA–2021–0053–0085, at 1; Ceres, Docket No. NHTSA–2021–0053–0076, at 1; many individual citizen commenters who submitted form letters to the docket beginning with "As a person of faith and conscience . . ."; and many individual citizen commenters at the public hearing.

¹⁰⁹⁰ Climate Group, Docket No. NHTSA–2021–0053–0052, at 1.

¹⁰⁹¹ ELPC public hearing comments, Docket No. NHTSA–2021–0053–0060, at 1.

¹⁰⁹² American Lung Mid-Atlantic, Docket No. NHTSA–2021–0053–0067, at 3.

¹⁰⁹³ Sierra Club public hearing comments, Docket No. NHTSA–2021–0053–0562, throughout.

¹⁰⁹⁴ UCS public hearing comments, Docket No. NHTSA–2021–0053–1085, at 1–2, and UCS, Docket No. NHTSA–2021–0053–1567, at 3–4.

¹⁰⁹⁵ SELC, Docket No. NHTSA–2021–0053–1495, at 1–2.

¹⁰⁹⁶ ZETA, Docket No. NHTSA–2021–0053–1510, at 1.

¹⁰⁹⁷ ACEEE, Docket No. NHTSA–2021–0053–0074, at 6.

¹⁰⁹⁸ Great Lakes and Midwest Environmental Organizations, Docket No. NHTSA–2021–0053–1520, at 1.

¹⁰⁹⁹ National Parks Conservation Association, Docket No. NHTSA–2021–0053–1569, at 2.

¹¹⁰⁰ UCS citizen-member letters, Docket No. NHTSA–2021–0053–1583, at 1.

¹¹⁰¹ Consumer Reports, Docket No. NHTSA–2021–0053–1576–A7, at 1.

¹¹⁰² NRDC, Docket No. NHTSA–2021–0053–1594, at 1.

¹¹⁰³ Sierra Club, Docket No. NHTSA–2021–0053–1611, at 1.

United States from global oil price instabilities, and reduce the impact of oil consumption on the environment.”¹¹⁰⁴ ACEEE similarly commented that maximum feasible “means that NHTSA is empowered and required to push efficiency as far as technically feasible. Maximizing fuel savings would deliver the greatest fuel cost savings to consumers and greatest benefits to public health and national security.”¹¹⁰⁵ EDF similarly commented that “maximum feasible” means prioritizing energy conservation.¹¹⁰⁶ EDF thus stated that the statutory factors were balanced appropriately in the proposal because “NHTSA recognize[d] that the need of the U.S. to conserve energy must include serious consideration of the energy security risks of continuing to consume oil, which more stringent fuel economy standards can reduce.”¹¹⁰⁷ South Coast AQMD stated that the 2020 final rule had interpreted the need of the U.S. to conserve energy incorrectly, and argued that “NHTSA should make unequivocal

that the statute-set purpose of EPCA to conserve energy necessarily requires affording that statutory factor great weight in setting fuel economy standards, and the agency lacks authority to alter the relative priorities set by Congress.”¹¹⁰⁸ Mr. Douglas commented that “[t]he agency is explicitly directed [by statute] to maximize fuel economy, *not economic prosperity*. Nor is the agency directed to maximize the ease by which automakers might overcome technological barriers while still remaining profitable.”¹¹⁰⁹ Other commenters argued that choosing Alternative 3 would represent the best balancing of all statutory factors, and also would be optimal for energy conservation and its attendant effects.¹¹¹⁰

With regard to another subset of considerations under the need of the U.S. to conserve energy, a coalition of health-oriented organizations commented that NHTSA should finalize standards at least as stringent as Alternative 3 to maximize long-term

health benefits and achieve health equity nationwide.¹¹¹¹ The Carbon Fuel Alliance also commented that Alternative 3 was best for meeting health and environmental concerns,¹¹¹² and Bay Area Air Quality Management District and the Mid-Atlantic Regional Council Air Quality Forum both commented that Alternative 3 was best for climate, air quality, and equity.¹¹¹³

NHTSA continues to believe, as many commenters agreed, that Alternative 3 best meets the need of the U.S. to conserve energy of the regulatory alternatives considered, because it saves the most fuel, which means that it maximizes consumer savings on fuel costs, reduces climate emissions by the greatest amount, and reduces U.S. participation in global oil markets, with attendant benefits to energy security and the national balance of payments. The table below shows, among other things, NHTSA’s estimated quantified private and social benefits associated with the need of the U.S. to conserve energy.

¹¹⁰⁴ California Attorney General et al., Docket No. NHTSA–2021–0053–1530, at 22.

¹¹⁰⁵ ACEEE, Docket No. NHTSA–2021–0053–0074, at 4.

¹¹⁰⁶ EDF, Docket No. NHTSA–2021–0053–1617, at 2.

¹¹⁰⁷ EDF, Docket No. NHTSA–2021–0053–1617, at 6.

¹¹⁰⁸ South Coast AQMD, Docket No. NHTSA–2021–0053–1477, at 2.

¹¹⁰⁹ Peter Douglas, Docket No. NHTSA–2021–0053–0085, at 14.

¹¹¹⁰ See, e.g., South Coast AQMD, Docket No. NHTSA–2021–0053–1477, at 6; WDNR, Docket No. NHTSA–2021–0053–0059, at 2; Ceres, Docket No. NHTSA–2021–0053–0076, at 1.

¹¹¹¹ American Lung Association, Docket No. NHTSA–2021–0053–1502, at 1.

¹¹¹² Carbon Fuel Alliance, Docket No. NHTSA–2021–0053–1475, at 2.

¹¹¹³ Bay Area Quality Management Air District, Docket No. NHTSA–2021–0053–1472, at 2–4; Mid-Atlantic Regional Council Air Quality Forum, Docket No. NHTSA–2021–0053–1470, at 1.

Table VI-11 – Incremental Benefits and Costs Over the Lifetimes of Total Fleet Produced Through 2029 (2018\$ Billions), 3 Percent Discount Rate, by Alternative, Average SC-GHG

Alternative	1	2	2.5	3
Private Costs				
Technology Costs to Increase Fuel Economy	31.7	67.4	76.4	100.2
Increased Maintenance and Repair Costs	0.0	0.0	0.0	0.0
Opportunity Cost in Other Vehicle Attributes	0.0	0.0	0.0	0.0
Consumer Surplus Loss from Reduced New Vehicle Sales	0.0	0.2	0.3	0.5
Safety Costs Internalized by Drivers	5.0	7.9	8.7	10.7
Subtotal – Incremental Private Costs	36.7	75.4	85.4	111.4
External Costs				
Congestion and Noise Costs from Rebound-Effect Driving	6.1	9.8	10.8	13.0
Safety Costs Not Internalized by Drivers	4.5	8.8	9.7	12.8
Loss in Fuel Tax Revenue	11.3	20.0	22.4	28.6
Subtotal – Incremental External Costs	21.9	38.5	43.0	54.4
Total Incremental Social Costs	58.6	113.9	128.4	165.8
Private Benefits				
Reduced Fuel Costs	52.5	88.1	98.2	123.5
Benefits from Additional Driving	9.9	14.9	16.4	19.8
Less Frequent Refueling	0.3	-1.3	-0.8	0.1
Subtotal – Incremental Private Benefits	62.7	101.7	113.8	143.4
External Benefits				
Reduction in Petroleum Market Externality	0.9	1.6	1.8	2.3
Reduced Climate Damages, Average SC-GHG	14.4	24.6	27.5	34.8
Reduced Health Damages	1.2	1.5	1.5	1.7
Subtotal – Incremental External Benefits	16.5	27.7	30.8	38.8
Total Incremental Social Benefits, Average SC-GHG	79.2	129.4	144.6	182.2
Net Incremental Social Benefits, Average SC-GHG				
	20.6	15.5	16.3	16.4

Saving money on fuel and reducing CO₂ and other pollutant emissions by reducing fuel consumption are also important equity goals. NHTSA recognizes the comments discussed in Section VI.A which suggested that fuel expenditures are a more significant budget item for citizens who are part of lower-income and disadvantaged communities. Part of our goal in determining maximum feasible CAFE standards is trying to improve fuel savings across the fleet as a whole, rather than for a handful of new vehicle buyers. By maximizing fuel savings to consumers, CAFE standards can help to improve equity. By maximizing CO₂ reductions, the U.S. is able to achieve the most toward reaching our goals under the Paris Climate Agreements, President Biden's goals as set forth via

Executive order, and to maximize climate equity concerns.

The Final SEIS finds that overall, projected changes in both upstream and downstream emissions of criteria and toxic air pollutants are generally beneficial but still mixed, with emissions of some pollutants remaining constant or increasing and emissions of some pollutants decreasing. These increases are associated with both upstream and downstream sources, and therefore, may disproportionately affect minority and low-income populations that reside in proximity to these sources. However, the magnitude of the change in emissions relative to the No-Action Alternative is minor for all action alternatives, and would not be characterized as high or adverse; over time, adverse health impacts are

projected to decrease nationwide under each of the action alternatives.

While NHTSA recognizes the comments discussed above in Section VI.A suggesting that eventual fleet electrification could create new energy security questions, the CAFE standards in this time frame are not the but-for cause of those questions. NHTSA will continue to monitor these questions going forward.

On that note, however, many comments received to the NPRM discussed vehicle electrification. These comments are part of why the issues are increasingly intertwined, because these commenters believe electrification touches at least three and possibly all of the statutory factors simultaneously—technological feasibility (to some extent), economic practicability (to a

greater extent), the effect of other motor vehicle standards of the Government on fuel economy (also to a greater extent), and the need of the United States to conserve energy (also to a greater extent, as discussed already). Some comments mentioned it in terms of whether industry was committed to electrification¹¹¹⁴ or insufficiently committed to electrification,¹¹¹⁵ or whether the CAFE standards would result in sufficient levels of electrification in order to meet climate

¹¹¹⁴ See, e.g., Auto Innovators, Docket No. NHTSA–2021–0053–1492, at 11–12 (stating that the same day as President Biden’s announcement of the Executive order establishing the electrification target for 2030, “. . . multiple automobile manufacturers announced a shared aspiration to achieve sales of 40–50 [percent] of annual U.S. volumes of EVs by 2030 to move the nation closer to a zero-emissions future consistent with Paris climate goals. Other automobile manufacturers made similar commitments leading up to and following the signing of E.O. 14037. Collectively, automakers have committed to investing more than \$330 billion to transforming cars and trucks to an exciting, electrified future, and are on pace to debut almost 100 BEV models by the end of 2024.”). See also Volvo, Docket No. NHTSA–2021–0053–1565, at 2 (“Volvo Cars is committed to electrification and every new Volvo motor launched since 2019 has had an electric motor. Over the next four years, Volvo Cars is launching a fully electric car every year and our aim is to make all-electric cars 50 [percent] of global sales by 2025, with the rest hybrids.”); Stellantis, Docket No. NHTSA–2021–0053–1527, at 1 (stating that it planned “to spend over \$35 billion to support a targeted 40 [percent] electric vehicle mix—consisting of plug-in hybrid and battery electric vehicles—in the U.S. by 2030. This includes investments in developing four all-new electric platforms.”); Nissan, Docket No. NHTSA–2021–0053–0022, at 3 (stating that “As part of its corporate sustainability efforts, . . . In January 2021 . . . Nissan announced that every all-new Nissan vehicle offered in Japan, China, Europe, and the U.S. will be electrified by the early 2030s. Further, in August 2021, Nissan set an ambitious target that 40 percent of its U.S. vehicle sales by 2030 will be fully electric, with even more to be electrified.”).

¹¹¹⁵ See, e.g., Tesla, Docket No. NHTSA–2021–0053–1480–A1, at 6 (commenting that “NHTSA should set standards that are technology forcing” and that “this technology forcing component compels NHTSA to adopt Alternative 3 with additional stringency to set the country on a pathway to encourage widespread deployment of ZEVs.”); Lucid, Docket No. NHTSA–2021–0053–1584, at 4 (stating that “Alternative 3 would meet the statutory requirement to set fuel efficiency standards at the maximum feasible level, push the automobile industry away from continued reliance on ICE vehicles, and ensure its focus remains on increasing electrification,” and pointing to NHTSA’s conclusions in the NPRM that Alternative 3 likely best met the need of the U.S. to conserve energy.); Rivian, Docket No. NHTSA–2021–0053–1562, at 7 (stating that current EV sales trajectories indicated that much more electrification was possible, stating that “The industry is ready to meet new challenges, and this is a moment for doubling down on the ambition of our fuel economy standards.”).

goals.¹¹¹⁶ Many industry comments expressed commitment to electrification and climate goals, but concurrently argued that the proposed standards would require *too much* electrification¹¹¹⁷ and that in order to meet those stated commitments to electrification and climate goals, no further improvements on the remaining ICE vehicles should be required,¹¹¹⁸ and

¹¹¹⁶ See, e.g., ICCT, Docket No. NHTSA–2021–0053–1581, at 13 (“The proposed CAFE standards may not ensure even the modeled 14.4 [percent] market share of electric vehicles, as conventional technology could be implemented at much higher rates than modeled for the proposed rule instead of increasing electric vehicle share to 14.4 [percent]. Without the additional stringency of Alternative 3, the standards for years 2027–2030 will have to be that much more ambitious in order to meet the target set by the President and achieve fuel consumption reductions that are clearly feasible and consistent with NHTSA’s statutory mandate.”); Securing America’s Future Energy, Docket No. NHTSA–2021–0053–1513, at 7 (stating that the NPRM had not established that automakers were incapable of meeting Alternative 3, and that “For there to be any possibility of EV sales approaching President Biden’s goal, NHTSA must consider a more stringent standard.”); Tesla, Docket No. NHTSA–2021–0053–1480–A1, at 4 (stating that Alternative 3 would result in more electrification and be consistent with the President’s call for more fleet electrification.); Rivian, Docket No. NHTSA–2021–0053–1562, at 3 (Alternative 2 would be “inconsistent with the . . . Biden Administration’s stated goals and priorities”); Our Children’s Trust, Docket No. NHTSA–2021–0053–1587, at 2 (“Many studies have shown that the U.S. vehicle fleet to be regulated by this CAFE standard can and should be 100 [percent] electric by 2030,” and “This rule should be on track to require the industry to do so.”).

¹¹¹⁷ See, e.g., Nissan, Docket No. NHTSA–2021–0053–0022, at 7 (stating that the proposed standards would actually require more electrification than NHTSA estimated, and that because “the level of EV market development and implementation of critical EV market policies remains uncertain, considering more stringent standards than those proposed is premature during this rulemaking time period.”); Stellantis, Docket No. NHTSA–2021–0053–1527, at 13 (stating that to meet even Alternative 2, “significant market penetration of strong electrification (e.g., hybrid, PHEV, or FCEV) is needed,” because 8 percent year over year increases “significantly outpaces historical improvements achieved with internal combustion engine technology” and “Eleven of fourteen major automakers have fallen behind EPA’s MY2019 standards as they have been adding technology since 2012.”); Kia, Docket No. NHTSA–2021–0052–1525, at 3 (stating that 8 percent increases were “unprecedented” and “with virtually no lead-time and without the inclusion of all vehicle types (specifically, dedicated EV platforms)—will be a challenge to meet at a manageable price for all consumers.”); AFPM, Docket No. NHTSA–2021–0053–1530, at 1–2 (stating that the proposal would have set CAFE standards “at a level that is not feasibly achievable by ICEVs, effectively establishing a partial EV mandate.”). Mr. Kreucher also commented that electric vehicles do not pay back in fuel savings over their lifetimes, and do not result in genuine climate benefits. Walter Kreucher, Docket No. NHTSA–2021–0053–0013, at 12.

¹¹¹⁸ See, e.g., Ford, Docket No. NHTSA–2021–0053–1545, at 1 (stating that further fuel efficiency

significant government assistance would be necessary regardless.¹¹¹⁹ Other comments (often from the same commenters) insisted that NHTSA must attend to the levels of electrification being deployed (in order to avoid requiring further investments in improving ICE-technology vehicles), while concurrently noting that Congress prohibited consideration of the fuel economy of BEVs in determining maximum feasible fuel economy.¹¹²⁰

improvements to ICE vehicles “will be marginal, and will come at high cost. Ford requests that the agencies . . . ensure that resources and investment are not diverted from our primary objective: Fulfilling President Biden’s goal of achieving 40–50 [percent] ZEV sales by 2030.”); GM, Docket No. NHTSA–2021–0053–1523, at 2, 4 (stating that “The standards should not force industry to split its resources between investments in legacy propulsion technologies and electric vehicles, as this will slow down the nation’s progress toward its climate commitments” and that “Every dollar spent propping up legacy engines is a dollar not spent on the investments necessary for future battery electric vehicles.”); Stellantis, Docket No. NHTSA–2021–0053–1527, at 12 (arguing that even if manufacturers could meet the proposed MYs 2024–2026 standards with conventional ICE technology, “it would make little economic sense to pursue a duplicate ICE investment path only to abandon it a few short years later to meet 2030 electrification goals.”); ZETA, Docket No. NHTSA–2021–0053–1510, at 2 (“More stringent standards will incentivize all auto manufacturers to produce more EVs—rather than strive to make inherently inefficient ICEVs marginally more efficient.”); AVE, Docket No. NHTSA–2021–0053–1488–A1, at 5 (stating that the NPRM had cited automaker announcements about electrification but “NHTSA does not, however, cite recent announcements that indicate several OEMs would not be making new investments in ICE architectures. NHTSA should account for the impact these decisions could have on overall fuel economy performance.”).

¹¹¹⁹ See, e.g., Auto Innovators, Docket No. NHTSA–2021–0053–1492, at 12 (stating that in order to “grow EV sales through MY 2026 and significantly expand those sales beyond MY 2026,” the United States would need (1) significant investments in refueling infrastructure, (2) consumer purchase incentives from the government, (3) government requirements that private and commercial fleets adopt electric vehicles, (4) government development of domestic supply chains, (5) a nationwide low carbon fuel standard, (6) government creation of a battery and vehicle component recycling system, (7) government investment in R&D, (8) government education of consumers, (9) government efforts to improve the availability, variety, and affordability of EVs, and (10) for all parties to “hold ourselves collectively accountable to metrics and milestones that align with state and nationwide targets of EVs.”); UAW, Docket No. NHTSA–2021–0053–0931, at 2–3 (stating that “The achievability of these standards and their impact on the U.S. auto industry will depend on additional [government intervention and] policies that promote domestic manufacturing and support quality jobs.”).

¹¹²⁰ See comments discussed and responded to in Section VI.A.5.e).

Many comments, as discussed elsewhere,¹¹²¹ either agreed or disagreed with NHTSA's inclusion of State ZEV requirements in the analytical baseline. Many comments also either agreed or disagreed with NHTSA's statements in the NPRM that manufacturer announcements about future electrification or corporate zero-emissions targets, or actual rollout of new electric vehicle models, were evidence of manufacturer capability to raise fuel economy levels in a way that seemed likely to be economically practicable.¹¹²²

In response, NHTSA has grappled extensively with how to consider these comments as we consider what levels of CAFE standards would be maximum feasible in MYs 2024–2026. Recognizing the 49 U.S.C. 32902(h) prohibition, NHTSA has limited electrification as a technology option in our analysis of how manufacturers might respond to the different regulatory alternatives during the rulemaking time frame. NHTSA therefore does not consider the fuel economy of electric vehicles in setting maximum feasible CAFE standards, consistent with Congress' direction. However, it remains a compliance option that many automakers are pursuing, and moreover, it would seem absurd to ignore the fact that NHTSA is setting these CAFE standards in the context of a much larger conversation about the future of the U.S. light-duty vehicle fleet, and for that matter, because of the nexus to climate change, the future of the planet and its inhabitants.

We acknowledge the comments from industry about what additional government support (such as infrastructure improvements and consumer purchase incentives for electric vehicles) would be desirable in their efforts to reach those goals, but of course many of those requests are outside of NHTSA's authority, and outside the scope of this final rule.

With regard to the economic practicability factor, the agency attempts to evaluate where the tipping point in the balancing of factors might be through a variety of metrics, examined in more detail below. If the amounts of technology or per-vehicle cost increases required to meet the standards appeared to be beyond what we believe the market could bear; or sales and employment appear to be unduly impacted, the agency could have decided that the standards represented

by a regulatory alternative under consideration may not be economically practicable. Even though NHTSA recognizes that the amount of lead time available before MY 2024 is less than what was provided in the 2012 rule, as will be discussed further below, NHTSA believes that the evidence suggests that the final standards are still economically practicable, even though they will be more challenging for some portions of the industry than others. CAFE standards can also help support industry in their intention to transition to a higher-fuel-economy fleet by requiring ongoing improvements even if demand for more fuel economy flags unexpectedly.

We underscore again, as throughout this preamble, that the modeling analysis does not dictate the “answer,” it is merely one source of information among others that aids the agency's balancing of the standards. We similarly underscore that there is no single bright line beyond which standards might be economically impracticable, and that these metrics are not intended to suggest one; they are simply ways to think about the information before us.

One way that economic practicability may be evaluated is in terms of how much technology manufacturers would have to apply to meet a given regulatory alternative. Technology application can be considered as “which technologies, and when”—both the technologies that NHTSA's analysis suggests would be used, and how that application occurs given manufacturers' product lifecycles. NHTSA agrees with commenters who suggested that the need of the U.S. to conserve energy may encourage the agency to be more technology-forcing in its balancing, and finds, as discussed in Section VI.A, that technological feasibility is not limiting in this rulemaking time frame given the state of technology in the industry. That said, regulatory alternatives that can only be achieved by the extensive application of advanced technologies (that may have known or unknown consumer acceptance issues) may not be economically practicable in this time frame, and may thus be beyond maximum feasible.¹¹²³

In terms of the levels of technology required and which technologies those may be, NHTSA's analysis estimates manufacturers' product “cadence,” representing them in terms of estimated schedules for redesigning and “freshening” vehicles, and assuming

that significant technology changes will be implemented during vehicle redesigns—as they historically have been. Once applied, a technology will be carried forward to future model years until superseded by a more advanced technology. NHTSA does not consider model years in isolation in the analysis, because doing so would be inconsistent with how industry responds to standards, and thus would not accurately reflect practicability. If manufacturers are already applying technology widely and intensively to meet standards in earlier years, requiring them to add yet more technology in the model years subject to the rulemaking may be less economically practicable; conversely, if the preceding model years require less technology, more technology during the rulemaking time frame may be more economically practicable. The tables below illustrate how the agency has modeled that process of manufacturers applying technologies to comply with different alternative standards. The TSD accompanying this document described the technologies and corresponding input estimates (of, *e.g.*, efficacy and cost) in detail in Chapters 2 and 3. The accompanying FRIA and appendices provide extensive detail regarding the estimated application of specific technologies to each manufacturers' fleets of passenger cars and light trucks in each model year. Finally, the underlying model outputs available on NHTSA's website provide estimates of the potential to apply specific technologies to specific vehicle model/configurations in each model year. In response to the commenters who stated that the proposed standards would require more electrification (*i.e.*, in particular, BEVs) than the NPRM showed, that is not what NHTSA's analysis finds. The following two tables show average incremental application rates—that is, levels beyond those projected under the No-Action Alternative—by regulatory alternative for selected technologies, including electrification technologies. For example, our analysis indicates that under the proposed standards (Alternative 2), the application of strong HEVs (HEVs) to passenger cars in MY 2026 could increase by 10 percent (of total passenger car production) compared to the levels projected to occur under the No-Action Alternative, and by 14 and 17 percent, respectively, under Alternative 2.5 and Alternative 3:

¹¹²¹ See Sections IV.B and VI.A.

¹¹²² See Section VI.A.

¹¹²³ NHTSA does not mean to preclude the possibility that future fuel economy standards may be even more technology-forcing than the ones promulgated in this final rule, because we

anticipate that, among other things, consumer acceptance toward advanced fuel economy-improving technologies will continue to grow, as it is clearly doing at the present time.

Table VI-12 – Estimated Change (vs. No-Action Alternative) in Application of Selected Technologies, Passenger Cars, Alternative 2, Alternative 2.5, and Alternative 3, Standard Setting Analysis

Tech	Alt	2020	2023	2024	2025	2026
Strong Hybrid (all types)	2	-	0	+2	+7	+10
PHEV (all types)	2	-	0	+1	+1	+2
BEV (all ranges)	2	-	+2	+2	+2	+2
Advanced Engines ³	2	-	+1	0	-1	-4
Advanced AERO ¹	2	-	+2	+25	+30	+32
MR4 ²	2	-	+5	+13	+18	+25
Strong Hybrid (all types)	2.5	-	+1	+5	+9	+14
PHEV (all types)	2.5	-	0	+1	+1	+2
BEV (all ranges)	2.5	-	+2	+2	+2	+2
Advanced Engines ³	2.5	-	+1	-1	-2	-5
Advanced AERO ¹	2.5	-	+2	+25	+31	+32
MR4 ²	2.5	-	+5	+13	+19	+25
Strong Hybrid (all types)	3	-	+2	+7	+12	+17
PHEV (all types)	3	-	0	+1	+2	+3
BEV (all ranges)	3	-	+2	+2	+2	+2
Advanced Engines ³	3	-	+1	+1	-1	-4
Advanced AERO ¹	3	-	+2	+25	+31	+33
MR4 ²	3	-	+5	+19	+26	+32

¹ Combined penetration of 15 and 20 percent aerodynamic improvement

² Reduce glider weight by 15 percent

³ Combined penetration of advanced cylinder deactivation, advanced turbo, variable compression ratio, high compression ratio and diesel engines

For light trucks, increases in estimated SHEV application show broadly similar trends, impacting an

additional 17 percent of the overall light truck market by MY 2026 under the

most stringent regulatory alternative considered here:

Table VI-13 – Estimated Change (vs. No-Action Alternative) in Application of Selected Technologies, Light Trucks, Alternative 2, Alternative 2.5, and Alternative 3, Standard Setting Analysis

Tech	Alt	2020	2023	2024	2025	2026
Strong Hybrid (all types)	2	-	0	+3	+7	+13
PHEV (all types)	2	-	0	0	0	+1
BEV (all ranges)	2	-	+1	+1	+1	+1
Advanced Engines ³	2	-	+1	+2	+4	+6
Advanced AERO ¹	2	-	0	+12	+14	+17
MR4 ²	2	-	+1	+1	+4	+8
Strong Hybrid (all types)	2.5	-	0	+3	+7	+13
PHEV (all types)	2.5	-	0	0	0	+3
BEV (all ranges)	2.5	-	+1	+1	+1	+1
Advanced Engines ³	2.5	-	+1	+1	+4	+8
Advanced AERO ¹	2.5	-	0	+12	+14	+16
MR4 ²	2.5	-	+1	+1	+5	+8
Strong Hybrid (all types)	3	-	+1	+8	+10	+17
PHEV (all types)	3	-	0	+1	+3	+4
BEV (all ranges)	3	-	+1	+1	+1	+1
Advanced Engines ³	3	-	+1	-1	0	+5
Advanced AERO ¹	3	-	0	+12	+14	+16
MR4 ²	3	-	+1	+4	+9	+14

¹ Combined penetration of 15 and 20 percent aerodynamic improvement

² Reduce glider weight by 15 percent

³ Combined penetration of advanced cylinder deactivation, advanced turbo, variable compression ratio, high compression ratio and diesel engines

The estimated increases in technology application shown in the preceding two tables are all computed relative to the No-Action Alternative, under which considerable fuel-saving technology is applied beyond that already present on the MY 2020 fleet used as the baseline for this analysis. As discussed above and in the FRIA and TSD accompanying this document, the No-Action Alternative includes fuel-saving technology applied in response to baseline (set in 2020) CAFE and CO₂ standards, fuel prices, agreements some manufacturers have reached with California regarding national CO₂ levels to be achieved through MY 2026, and ZEV mandates in place in California and

other States. The effects of this baseline application of technology are not attributable to this action, and NHTSA has therefore excluded these from the agency's estimates of the incremental benefits and costs that could result from each Action alternative considered here. Some manufacturers and other stakeholders have called for NHTSA to consider the accumulated impacts of successive actions, logically implying that NHTSA should be reporting on technologies deployed since DOT first imposed fuel economy standards in the late 1970s, such as front-wheel drive configurations, unibody construction, and 4-speed automatic transmissions. NHTSA disagrees that such an

accounting would be informative toward the decisions regarding tomorrow's fuel economy standards. Nevertheless, within its context, which starts with the MY 2020 fleet, our analysis does account for technology present in the MY 2020 fleet, and any additional technology estimated to potentially be applied under the No-Action Alternative. Including this technology results in the estimated technology market shares (also referred to as technology [market] penetration rates) summarized in the following two tables:

BILLING CODE 4910-59-P

Table VI-14 – Estimated Market Share (%) of Selected Technologies, Passenger Cars, Alternative 2, Alternative 2.5, and Alternative 3, Standard Setting Analysis

Tech	Alt	2020	2023	2024	2025	2026
Strong Hybrid (all types)	0	3	5	6	6	7
PHEV (all types)	0	1	1	1	1	2
BEV (all ranges)	0	4	6	7	7	7
Advanced Engines ³	0	19	31	39	42	44
Advanced AERO ¹	0	8	46	51	56	60
MR4 ²	0	5	9	11	12	12
Strong Hybrid (all types)	2	3	5	8	13	17
PHEV (all types)	2	1	1	2	2	3
BEV (all ranges)	2	4	8	8	9	9
Advanced Engines ³	2	19	32	39	41	40
Advanced AERO ¹	2	8	48	76	87	92
MR4 ²	2	5	15	24	31	37
Strong Hybrid (all types)	2.5	3	6	11	16	20
PHEV (all types)	2.5	1	1	2	2	4
BEV (all ranges)	2.5	4	8	8	9	9
Advanced Engines ³	2.5	19	32	37	40	39
Advanced AERO ¹	2.5	8	48	76	87	92
MR4 ²	2.5	5	15	24	31	37
Strong Hybrid (all types)	3	3	7	13	19	23
PHEV (all types)	3	1	1	2	3	5
BEV (all ranges)	3	4	8	9	9	9
Advanced Engines ³	3	19	32	39	41	40
Advanced AERO ¹	3	8	48	76	87	92
MR4 ²	3	5	15	30	38	44

¹ Combined penetration of 15 and 20 percent aerodynamic improvement

² Reduce glider weight by 15 percent

³ Combined penetration of advanced cylinder deactivation, advanced turbo, variable compression ratio, high compression ratio and diesel engines

Table VI-15 – Estimated Market Share (%) of Selected Technologies, Light Trucks, Alternative 2, Alternative 2.5, and Alternative 3, Standard Setting Analysis

Tech	Alt	2020	2023	2024	2025	2026
Strong Hybrid (all types)	0	2	5	8	8	8
PHEV (all types)	0	<1	<1	<1	<1	<1
BEV (all ranges)	0	<1	1	1	2	2
Advanced Engines ³	0	12	32	37	40	45
Advanced AERO ¹	0	16	39	44	50	59
MR4 ²	0	11	13	13	14	14
Strong Hybrid (all types)	2	2	6	10	14	20
PHEV (all types)	2	<1	<1	<1	1	2
BEV (all ranges)	2	<1	2	2	2	3
Advanced Engines ³	2	12	33	38	44	51
Advanced AERO ¹	2	16	39	56	64	76
MR4 ²	2	11	13	14	17	22
Strong Hybrid (all types)	2.5	2	6	11	15	21
PHEV (all types)	2.5	<1	<1	1	1	3
BEV (all ranges)	2.5	<1	2	2	2	3
Advanced Engines ³	2.5	12	33	38	43	53
Advanced AERO ¹	2.5	16	39	56	64	75
MR4 ²	2.5	11	13	14	18	22
Strong Hybrid (all types)	3	2	7	15	18	25
PHEV (all types)	3	<1	<1	1	3	5
BEV (all ranges)	3	<1	2	2	2	3
Advanced Engines ³	3	12	33	35	40	50
Advanced AERO ¹	3	16	39	56	64	74
MR4 ²	3	11	13	17	23	27

¹ Combined penetration of 15 and 20 percent aerodynamic improvement

² Reduce glider weight by 15 percent

³ Combined penetration of advanced cylinder deactivation, advanced turbo, variable compression ratio, high compression ratio and diesel engines

BILLING CODE 4910-59-C

As the tables illustrate, Alternative 2, Alternative 2.5, and Alternative 3 appear to require rapid deployment of fuel efficiency technology across a variety of vehicle systems—body improvements due to weight reduction and improved aerodynamic drag, engine advancements, and electrification.¹¹²⁴

¹¹²⁴ While these technology pathways reflect NHTSA's statutory restrictions under EPCA/EISA, it is worth noting again that they represent only one possible solution. In the simulations that support the Final SEIS, PHEV market share grows by less, and is mostly offset by an increase in BEV market share.

However, importantly, the aggressive application that is simulated to occur between MY 2020 (which NHTSA observed and is the starting point of this analysis) and MY 2023 occurs in all of the alternatives, for both cars and light trucks. This reflects technology application by manufacturers participating in the California Framework Agreements and existing compliance positions (in some fleets) across the industry to improve fuel economy in the near-term.

As the results summarized above showed, while NHTSA's analysis suggests some increase in SHEV

penetration rates between alternatives 2 and 3, PHEVs and BEVs are (logically) limited—but in response to the comments about the standards requiring too much electrification, widespread compliance can be achieved with minimal further application of PHEVs or BEVs for *any* of the regulatory alternatives considered in this final rule. SHEV may still have plenty of room to grow in the market to reach the levels suggested by the analysis, but hybrid offerings have been increasing rapidly in number and variety, and some new offerings have been so popular that manufacturers cannot keep up with

demand,¹¹²⁵ which seems to bode well for future growth opportunities.

Of course, CAFE standards are performance-based, and NHTSA does not dictate specific technology paths for meeting them, so it is entirely possible (even entirely foreseeable) that individual manufacturers and industry as a whole will take a different path from the one that NHTSA presents here. Nonetheless, this is a path toward compliance, relying on known, existing technology, that may (if used) address some of the consumer acceptance concerns raised by industry commenters about the future levels of electrification to which they are all committing. However, if automakers would prefer to rely more heavily on BEVs, for example, for CAFE compliance, and less heavily on the SHEVs that we show in this analysis, they are free to do so.

NHTSA also recognizes the industry comments suggesting that further investments in improving vehicle fuel economy with ICE technologies are not investments in electrification. Other comments suggested that ICE technologies still had room to improve and could be added cost-effectively during the rulemaking time frame.¹¹²⁶ As the tables above showed, Alternatives 2, 2.5, and 3 are all estimated to require fairly widespread deployment of advanced AERO and MR4 (although particularly in the case of MR4, this may be an artifact of the statutory restrictions reflected in the “standard-setting” modeling runs), as well as additional application of SHEVs. While, again, CAFE standards are performance-based and manufacturer technology solutions to meet the standards will certainly be different from what NHTSA presents here, NHTSA believes that these levels of vehicle technology and strong hybrid penetration are reasonable in the rulemaking time frame. NHTSA absolutely disagrees that these investments in improving vehicle technologies and hybrids, if actually made, would be “wasted,” as some comments suggest. Even if 50 percent of the new vehicle fleet was BEV, 50 percent of that same fleet would still not be BEV, and much higher percentages of the on-road fleet as a whole would continue not to be BEV for some time.

¹¹²⁵ See, e.g., <https://www.reuters.com/business/autos-transportation/ford-cut-orders-hybrid-pick-up-maverick-wsj-2022-01-24/> (accessed: March 15, 2022).

¹¹²⁶ See, e.g., ICCT, Docket No. NHTSA–2021–0053–1581, at 12–13. While NHTSA discusses ICCT’s comments on this topic in more detail in Section III above, NHTSA agrees with the basic principle that non-electric fuel economy may still be improved.

NHTSA believes it is consistent with the need of the U.S. to conserve energy for standards to encourage new vehicles across the fleet to continue improving, and that it is particularly consistent with equity concerns for consumers who purchase any vehicle to be able to benefit from the reduced fuel costs that more stringent CAFE standards could facilitate, even if they are not yet willing or able to purchase a BEV. Moreover, improving the fuel efficiency of new vehicles has effects over time, not just at point of first sale, on consumer fuel savings. Somewhat-more-expensive-but-more-efficient new vehicles eventually become more-efficient used vehicles, which may be purchased by consumers who may be put off by higher new vehicle prices. The benefits have the potential to continue across the fleet and over time, for all consumers regardless of their current purchasing power.

We are also cautiously optimistic that if automakers *do* continue to improve the fuel economy of their non-BEV vehicles, that it may actually improve fleetwide fuel consumption over time, given that the evidence suggests that ICE VMT has been than BEV VMT on average thus far. Many higher-fuel-economy ICEs (with or without SHEVs) may save more fuel as they drive through their lifetimes, than relatively fewer higher-fuel-economy ICEs and relatively few BEVs. Thus, although (again) CAFE standards are performance-based and NHTSA does not dictate a technology path, there may be energy conservation benefits beyond just the average fuel economy level from setting standards that lead to more technology applied to more vehicles across the fleets.

Another facet of automaker comments about their intent to invest in electrification rather than improving the fuel economy of non-electric models is simply the capital investments and R&D dollars expected to be directed to electrification—and thus, commenters suggested, unavailable for other uses. For example, Auto Innovators stated that its members had collectively committed to spending \$330 billion toward reaching the 2030 electrification goals, as part of arguing that CAFE standards should require no further investment in improving the fuel economy of the rest of the new vehicle fleet.

In response, NHTSA’s analysis seeks to account for manufacturers’ capital and resource constraints in several ways—through the restriction of technology application to refreshes and redesigns, through the phase-in caps applied to certain technologies, and

through the explicit consideration of vehicle components (like powertrains) and technologies (like platforms based on advanced materials) that are shared by models throughout a manufacturer’s portfolio. NHTSA is aware that there is a significant difference in the level of capital and resources required to implement one or more new technologies on a single vehicle model, and the level of capital and resources required to implement those same technologies across the entire vehicle fleet. NHTSA realizes that it would not be economically practicable to expand some of the most advanced technologies to every vehicle in the fleet within the rulemaking time frame, although it should be possible to increase the application of advanced technologies across the fleet in a progression that accounts for those resource constraints. That is what NHTSA’s analysis tries to do and what our selection of Alternative 2.5 reflects. While the tables above do not provide information at sufficient granularity, the per-vehicle cost tables that follow help to illustrate that technology is added at redesigns (as evidenced by increases in per-vehicle cost from one model year to the next for individual manufacturers), which helps ensure the practicability of the technology changes. Further, as always, manufacturers remain free to meet the standards using whatever technologies they choose. Thus, a decision to invest available research and development capital in BEV technology instead of advanced ICE technologies (or vice versa) is a compliance choice, not a requirement of this rule.

Hundreds of billions of dollars are large sums, but they are the collective effect of many decisions about per-vehicle costs. Another consideration for economic practicability is the extent to which new standards could increase the average cost to acquire new vehicles, because even insofar as the underlying application of technology leads to reduced outlays for fuel over the useful lives of the affected vehicles, these per-vehicle cost increases provide both a measure of the degree of effort faced by manufacturers, and also the degree of adjustment, in the form of potential vehicle price increases, that will ultimately be required of vehicle purchasers. Table VI–16, Table VI–17, and Table VI–18 show the agency’s estimates of average cost increase under the Preferred Alternative for passenger cars and light trucks, respectively. Because our analysis includes estimates of manufacturers’ indirect costs and profits, as well as civil penalties that some manufacturers (as allowed under

EPCA/EISA) might elect to pay in lieu of achieving compliance with CAFE standards, we report cost increases as estimated average increases in vehicle price (as MSRP). These are average values, and the agency does not expect that the prices of every vehicle would increase by the same amount; rather, the agency's underlying analysis shows unit costs varying widely between different vehicle models. For example, a small SUV that replaces an advanced internal combustion engine with a plug-in hybrid system may incur additional production costs in excess of \$10,000, while a comparable SUV that replaces a basic engine with an advanced internal combustion engine incurs a cost closer to \$2,000. While we recognize that manufacturers will distribute regulatory costs throughout their fleet to maximize profit, we have not attempted to estimate strategic pricing, having insufficient data (which would likely be confidential business information (CBI)) on which to base such an attempt. Additionally, even recognizing that manufacturers will distribute regulatory costs throughout their fleet, NHTSA still believes that average per-vehicle cost is illustrative of the affordability implications of new standards, as raised by NADA and other commenters. If the per-vehicle cost increases seem consistent with those previously found to be economically practicable, given what we estimate about conditions during the rulemaking time frame, it will seem more likely that the standards

causing those increases are economically practicable.

Relative to the vehicles that will be built anyway in the absence of further regulatory action by NHTSA, NHTSA judges these cost increases to be possible for the market to bear. Moreover, cost increases will be offset by fuel savings, which consumers will experience over the lifetime of the vehicle, if not concurrent with the upfront increase in purchase price. Further, as discussed above, the time period during which these technology costs would be paid off through reduced fuel expenditures aligns well with average vehicle financing periods, indicating that many consumers will experience the net fuel economy savings immediately. NADA commented that eventual fuel savings are not relevant to auto lending decisions, and thus do not improve vehicle affordability, but again, NHTSA believes that the additional cost attributable to the CAFE standards is feasible, particularly given the potential for fuel expenditure savings to accrue during vehicle financing periods, and notes that even with average MSRPs at historically high levels,¹¹²⁷ vehicles are still selling, often with dealer "market adjustments" that push the vehicle prices well over MSRP.¹¹²⁸ Whereas in

¹¹²⁷ <https://www.kbb.com/car-news/average-new-car-sales-price-now-over-46000/> (accessed March 15, 2022).

¹¹²⁸ <https://www.forbes.com/wheels/news/car-buying-advice-navigate-shortage/> (accessed March 15, 2022).

the 2020 final rule, NHTSA expressed concern about what appeared to be a growing trend of consumers finding themselves upside down on their auto loans, but as vehicle residual value continues to rise, NHTSA believes this may be less of an issue going forward unless vehicle prices collapse unexpectedly, which seems unlikely. Some of this is a function of limited vehicle supply, but even in that context, as discussed previously, nearly every manufacturer has already indicated their intent to continue introducing advanced technology vehicles between now and MY 2026. Again, NHTSA believes that manufacturers introduce new vehicles (and technologies) expecting that there is a market for them—if not immediately, then in the near future, because for-profit companies cannot afford to lose money indefinitely—and dealers currently seem able to accommodate consumers despite considerable price increases, so perhaps the situation is not as dire as NADA argued in its comments. This trend suggests that manufacturers believe that at least some cost increases should be manageable for consumers.

The tables below show additional technology costs estimated to be incurred under each action alternative as compared to the No-Action Alternative.

BILLING CODE 4910-59-P

Table VI-16 – Estimated Average Price Increase for Passenger Cars (2018 \$, vs. No-Action Alternative)

	2024				2025				2026			
	Alt. 1	Alt. 2	Alt. 2.5	Alt. 3	Alt. 1	Alt. 2	Alt. 2.5	Alt. 3	Alt. 1	Alt. 2	Alt. 2.5	Alt. 3
BMW	125	1	12	220	97	334	517	920	-53	696	918	1,369
Daimler	788	533	533	865	733	835	835	1,305	830	1,370	1,535	2,025
FCA (Stellantis)	635	452	452	591	817	986	984	1,297	770	1,662	2,038	2,307
Ford	319	1,589	1,591	1,596	507	1,668	1,674	1,688	532	1,436	1,442	1,564
GM	570	486	486	619	772	999	1,127	1,337	997	1,475	1,613	1,803
Honda	34	403	726	909	89	542	853	1,038	82	647	969	1,190
Hyundai	272	362	362	649	486	820	821	1,270	645	1,373	1,560	1,940
Kia	121	294	550	643	212	826	924	1,272	395	1,097	1,171	1,526
JLR	503	163	163	323	556	540	540	914	175	607	856	1,333
Mazda	206	267	284	303	305	715	803	1,180	398	872	956	1,310
Mitsubishi	575	473	473	610	398	961	1,149	1,479	399	947	1,131	1,436
Nissan	333	1,636	1,764	2,054	374	1,999	2,121	2,428	359	1,967	2,162	2,574
Subaru	523	523	523	958	589	747	746	1,238	592	1,137	1,310	1,819
Tesla	0	0	0	0	0	0	0	0	0	0	0	0
Toyota	221	484	560	810	225	548	623	882	223	571	653	970
Volvo	187	224	226	280	240	389	397	539	2,218	2,505	2,573	2,710
Volkswagen	-135	28	35	-171	-117	92	105	-35	-77	284	420	599
Average	278	614	701	882	364	897	995	1,254	426	1,107	1,265	1,559

Table VI-17 – Estimated Average Price Increase for Light Trucks (2018 \$, vs. No-Action Alternative)

	2024				2025				2026			
	Alt. 1	Alt. 2	Alt. 2.5	Alt. 3	Alt. 1	Alt. 2	Alt. 2.5	Alt. 3	Alt. 1	Alt. 2	Alt. 2.5	Alt. 3
BMW	174	289	291	247	159	261	264	255	149	331	374	450
Daimler	312	219	219	268	335	500	500	699	428	915	1,053	1,324
FCA (Stellantis)	273	110	112	207	428	514	514	740	540	901	990	1,270
Ford	-121	-72	-72	423	-116	-70	-70	555	-106	627	922	1,423
GM	792	481	481	712	1,010	1,221	1,222	1,833	1,075	1,883	2,159	2,669
Honda	-145	261	503	1,054	-261	272	504	1,076	-252	293	535	1,115
Hyundai	86	54	54	86	106	103	103	148	798	1,478	1,655	2,128
Kia	624	1,269	1,489	1,853	614	1,232	1,442	1,792	605	1,200	1,402	1,740
JLR	437	360	360	474	707	849	849	1,083	1,175	1,582	1,722	2,005
Mazda	65	16	17	34	194	573	714	720	219	932	1,243	1,203
Mitsubishi	661	435	434	580	716	1,006	1,197	1,600	711	997	1,183	1,567
Nissan	319	1,348	1,348	1,376	317	1,298	1,298	1,362	412	1,723	1,785	1,944
Subaru	238	238	238	373	257	302	302	456	226	226	226	349
Tesla	0	0	0	0	0	0	0	0	0	0	0	0
Toyota	892	937	937	1,447	863	893	893	1,382	901	899	961	1,628
Volvo	28	227	414	940	56	317	484	1,001	40	380	573	1,067
Volkswagen	612	-10	-9	313	589	178	179	643	592	450	538	1,079
Average	370	360	386	667	439	615	644	1,059	497	995	1,167	1,582

Table VI-18 – Estimated Average Price Increase for Passenger Cars and Light Trucks (2018 \$, vs. No-Action Alternative)

	2024				2025				2026			
	Alt. 1	Alt. 2	Alt. 2.5	Alt. 3	Alt. 1	Alt. 2	Alt. 2.5	Alt. 3	Alt. 1	Alt. 2	Alt. 2.5	Alt. 3
BMW	141	96	104	228	115	307	430	695	7	569	731	1,054
Daimler	557	377	376	570	537	664	662	995	632	1,139	1,290	1,667
FCA (Stellantis)	328	162	163	265	486	584	583	820	573	1,014	1,147	1,422
Ford	8	412	412	763	67	437	437	882	83	864	1,074	1,464
GM	715	483	483	680	927	1,144	1,189	1,660	1,047	1,740	1,968	2,368
Honda	-33	350	643	967	-39	446	727	1,062	-39	519	811	1,168
Hyundai	254	332	333	595	449	751	751	1,161	661	1,385	1,571	1,961
Kia	291	626	871	1,057	349	967	1,104	1,456	468	1,137	1,255	1,607
JLR	440	350	350	466	699	833	833	1,074	1,121	1,530	1,676	1,970
Mazda	136	142	150	167	246	636	748	939	304	887	1,080	1,238
Mitsubishi	619	452	452	594	563	983	1,173	1,541	559	972	1,156	1,502
Nissan	329	1,556	1,648	1,864	360	1,806	1,893	2,131	376	1,903	2,061	2,403
Subaru	309	308	308	518	340	411	410	645	318	453	495	709
Tesla	0	0	0	0	0	0	0	0	0	0	0	1
Toyota	505	677	721	1,082	495	697	741	1,100	510	717	791	1,261
Volvo	73	228	363	757	110	341	464	878	662	980	1,137	1,526
Volkswagen	255	7	11	82	249	137	143	323	267	370	482	852
Average	327	481	536	769	404	750	812	1,153	464	1,051	1,216	1,574

BILLING CODE 4910-59-C

While it is clear from the tables that results vary by manufacturer, by year, and by fleet,¹¹²⁹ the average results are still informative. Average per-vehicle cost increases for MY 2024, for all alternatives, are well under \$1,000; for MY 2025, there appears to be a significant inflection point between Alternatives 2.5 and 3; and for MY 2026, that inflection point remains, and seems especially pronounced for light trucks. As discussed in Section VI.A, while NHTSA has no bright-line rule regarding the point at which per-vehicle cost becomes economically impracticable, while the difference in cost between Alternatives 2 and 2.5 may be manageable, the difference between Alternatives 2 and 3 is more than 50–60 percent, and the number of cases in which manufacturers’ average MY 2026

costs appear to increase beyond \$2,000 per vehicle increases noticeably between Alternatives 2.5 and 3.

The table also illustrates that, in some respects, economic practicability points in the opposite direction than the need of the U.S. to conserve energy. Weighing the competing considerations, NHTSA believes that the large increase in the average per-vehicle cost between Alternatives 1 and 2 is worth the energy conservation benefits of choosing higher standards. The average per-vehicle cost increase between Alternatives 2 and 2.5 is smaller, and thus still worth the increased energy conservation benefits. The per-vehicle cost increase between Alternative 2.5 and 3, however, does not seem economically practicable in the rulemaking time frame, and it is within NHTSA’s discretion to forgo additional energy conservation benefits if NHTSA

believes that more stringent standards would be economically impracticable, and thus, beyond maximum feasible.

The estimated price increases shown in the preceding three tables are all computed relative to the No-Action Alternative, under which considerable fuel-saving technology is applied beyond that already present on the MY 2020 fleet, using this analysis as a starting point. Nevertheless, within its context, which starts with the MY 2020 fleet, our analysis does provide estimates of impacts attributable to technology applied in the baseline—that is, technology beyond that present in the MY 2020 fleet. For new vehicle prices, doing so results in the following estimated average price increases relative to the continued reliance on MY 2020 technologies:

¹¹²⁹ Honda commented to the NPRM that NHTSA should consider a slower rate of increase in stringency for passenger cars rather than light trucks, because the regulatory burden on passenger cars was higher, the MSRP tended to be lower (and

thus have more difficulty passing forward regulatory costs), and market share had declined in recent years. Honda, Docket No. NHTSA–2021–0053–1501, at 7. In response, while per-vehicle costs for all action alternatives look somewhat

higher in some years for passenger cars as compared to light trucks, the burden seems to even out by MY 2026. NHTSA does not believe that the evidence suggests that a slower rate of increase for passenger cars is necessary at this time.

Table VI-19 – Estimated Average Price Increase for Passenger Cars and Light Trucks (2018 \$, vs. Continued Application of MY 2020 Technology)

	2024				2025				2026			
	Alt. 1	Alt. 2	Alt. 2.5	Alt. 3	Alt. 1	Alt. 2	Alt. 2.5	Alt. 3	Alt. 1	Alt. 2	Alt. 2.5	Alt. 3
BMW	1,591	1,545	1,553	1,678	1,816	2,009	2,131	2,396	1,915	2,477	2,639	2,961
Daimler	1,774	1,595	1,594	1,787	2,022	2,149	2,147	2,480	2,224	2,731	2,882	3,259
FCA (Stellantis)	1,788	1,621	1,623	1,724	1,920	2,018	2,017	2,254	2,055	2,496	2,629	2,904
Ford	1,548	1,952	1,952	2,303	1,596	1,966	1,966	2,411	1,718	2,499	2,709	3,099
GM	1,501	1,270	1,270	1,467	1,890	2,107	2,152	2,623	2,009	2,702	2,930	3,330
Honda	623	1,006	1,300	1,623	1,024	1,509	1,790	2,125	1,187	1,745	2,037	2,395
Hyundai	857	935	935	1,198	1,087	1,388	1,389	1,798	1,372	2,096	2,282	2,672
Kia	880	1,214	1,459	1,645	921	1,539	1,676	2,028	1,066	1,736	1,854	2,205
JLR	1,531	1,440	1,440	1,556	1,844	1,978	1,978	2,219	2,320	2,729	2,875	3,169
Mazda	1,538	1,544	1,552	1,569	1,779	2,168	2,281	2,472	1,878	2,462	2,655	2,813
Mitsubishi	1,139	972	972	1,113	990	1,411	1,600	1,968	980	1,392	1,577	1,923
Nissan	914	2,141	2,234	2,450	1,042	2,488	2,575	2,813	1,100	2,627	2,785	3,127
Subaru	1,095	1,094	1,093	1,303	1,242	1,313	1,312	1,547	1,287	1,422	1,464	1,677
Tesla	29	29	29	29	34	34	34	34	33	33	33	33
Toyota	1,161	1,333	1,378	1,739	1,210	1,412	1,456	1,816	1,405	1,613	1,687	2,157
Volvo	1,746	1,901	2,036	2,430	1,960	2,191	2,314	2,728	2,694	3,012	3,169	3,558
Volkswagen	2,342	2,095	2,098	2,169	2,439	2,326	2,333	2,512	2,464	2,567	2,679	3,049
Average	1,283	1,438	1,493	1,726	1,468	1,814	1,876	2,217	1,608	2,195	2,360	2,718

With regard to timing of technology application, as discussed in Section VI.A, some commenters also disagreed with NHTSA's suggestion in the NPRM that while the MY 2024 standards provide less lead time for an increase in stringency than was provided by the standards set in 2012, the less-stringent CAFE standards for MYs 2021–2023 should provide a relative “break” for compliance purposes. In the context of determining how to balance the statutory factors, UAW argued that Alternative 2 represented a “significant and more rapid increase in stringency levels over the term of the regulations, particularly in comparison to current standards,” so UAW opposed “alternative proposals that would increase stringency levels beyond those proposed in Alternative 2, including the proposal to increase the stringency of Alternative 2 in 2026 by an additional 2 [percent] [*i.e.*, Alternative 2.5].”¹¹³⁰ UAW stated that “[a] drastic increase in standards for MY 2026 could undermine the overall achievability of regulations, discount the lead time required for automotive product planning, and fail to acknowledge the industry disruptions of recent years. After all, automakers are currently operating under the SAFE

standards put in place by the last administration.”¹¹³¹ JLR stated that Alternative 2.5 was not viable for them, because their product plans were already set through MY 2026 and they had been planning for, at most, the 2012 targets.¹¹³²

However, other commenters argued that the less-stringent CAFE standards for MYs 2021–2023 would provide automakers, especially those who had not deviated from planning to meet the standards set forth in 2012 or those who had signed onto the California Framework Agreements, an opportunity to over-comply in CAFE space to ease future compliance obligations. Consumer Reports commented that “[a]utomakers had agreed to [the Obama] levels of stringency in 2012 and had plans in place to meet them as recently as last year. With extra credits earned under the weak SAFE rule, they should easily be able to catch up. NHTSA should set the stringency in 2026 at least as strong as their Alternative 3. The U.S. is behind the curve on our climate commitments, and only setting aggressive CAFE targets will allow us to catch up.”¹¹³³ ACEEE agree

¹¹³¹ *Id.*

¹¹³² JLR, Docket No. NHTSA–2021–0053–1505, at 4.

¹¹³³ Consumer Reports, Docket No. NHTSA–2021–0053–1576–A9, at 5.

that “[s]etting stringency to maximize fuel savings can also help us reach the fuel savings we would have reached if the 2012 Final Rule were fully implemented.”¹¹³⁴

NHTSA cannot and does not consider the availability of credits in determining what levels of standards would be maximum feasible, so NHTSA does not mean to say that NHTSA believes that Alternative 2.5 is feasible for MYs 2024–2026 *because* manufacturers will be earning overcompliance credits in CAFE space during MYs 2021–2023. It is important, however, to consider the following facts (and would be absurd not to do so). First, in a world in which we are only considering CAFE standards, if the standards in the years immediately preceding the rulemaking time frame do not require significant additional technology application, then more technology should theoretically be available for meeting the standards during the rulemaking time frame. Second, if we reasonably believe that manufacturers' public statements indicate that they will be applying at least some of that technology regardless of the stringency of MY 2021–2023 CAFE standards, those manufacturers should be better positioned to comply

¹¹³⁴ ACEEE, Docket No. NHTSA–2021–0053–0074, at 4–5.

¹¹³⁰ UAW, Docket No. NHTSA–2021–0053–0931, at 2.

with the MY 2024–2026 standards—not because they have credits in the bank, but because their vehicles already have more technology on them, and their fleet fuel economy is simply higher than it would otherwise have been. This is what reassures NHTSA that the lead time for these standards is adequate. As discussed in Section VI.A, while automakers may have recently been selling relatively larger, heavier, lower-fuel-economy vehicles, we do not think that from a technology perspective, they really left the path laid out in 2012. JLR’s comment above supports this idea—their product plans are set and they had been planning for, at most, the 2012 targets.

NHTSA recognizes that lead time here is less than past rulemakings have provided, and that the economy and the country are in the process of recovering from a global pandemic. NHTSA also recognizes that at least parts of the

industry are nonetheless making announcement after announcement of new forthcoming advanced technology, high-fuel-economy vehicle models, and does not believe that they would be doing so if they thought there was no market at all for them. As discussed above, many industry comments trumpeted their own commitments and announcements while simultaneously expressing concern and uncertainty about consumer demand for the vehicles being committed to and announced. Perhaps some of the introductions are driven by industry perceptions of future regulation, but the fact remains that the introductions are happening even in the face of that uncertainty, and uncertainty about future government assistance with that transition. CAFE standards can help to buttress this momentum by continuing to require the fleets as a whole to improve their fuel economy levels steadily over the coming years, so

that a handful of advanced technology vehicles do not inadvertently allow backsliding in the majority of the fleet that will continue to be powered by internal combustion for likely the next 5–10 years. CAFE standards that increase steadily may help industry make this transition more smoothly.

Moreover, the standards represented by Alternative 2.5 actually give industry slightly *more* lead time to meet targets equivalent to those set forth in 2012. The figures below show when several of the different regulatory alternatives considered in this final rule would reach parity with the targets set forth in 2012. As shown, Alternative 1 would never reach the levels set forth in 2012, while Alternatives 2 and 2.5 would get there with slightly extra lead time for passenger cars and slightly more extra lead time for light trucks, and Alternative 3 would get there early as compared to 2012.

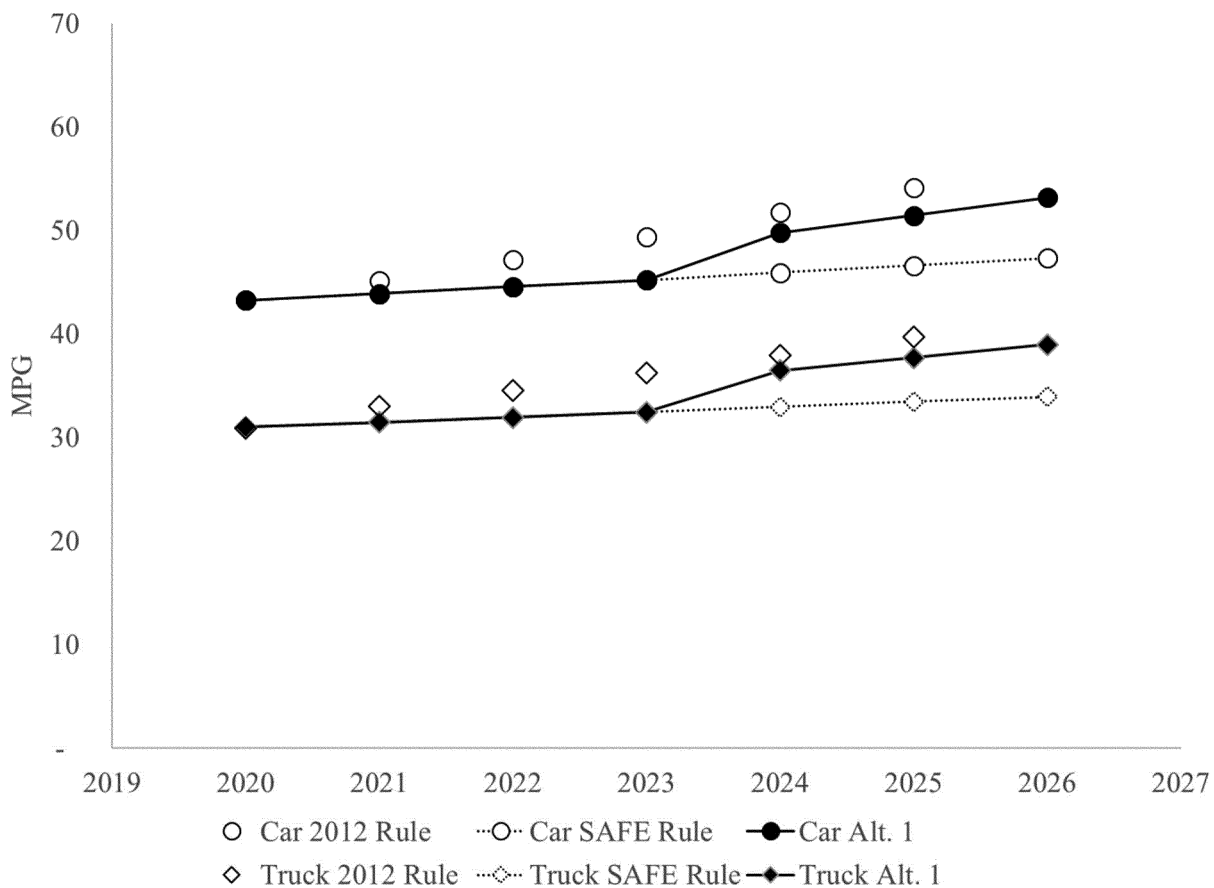

Figure VI-3 – Estimated Average Required CAFE Levels (Alternative 1)

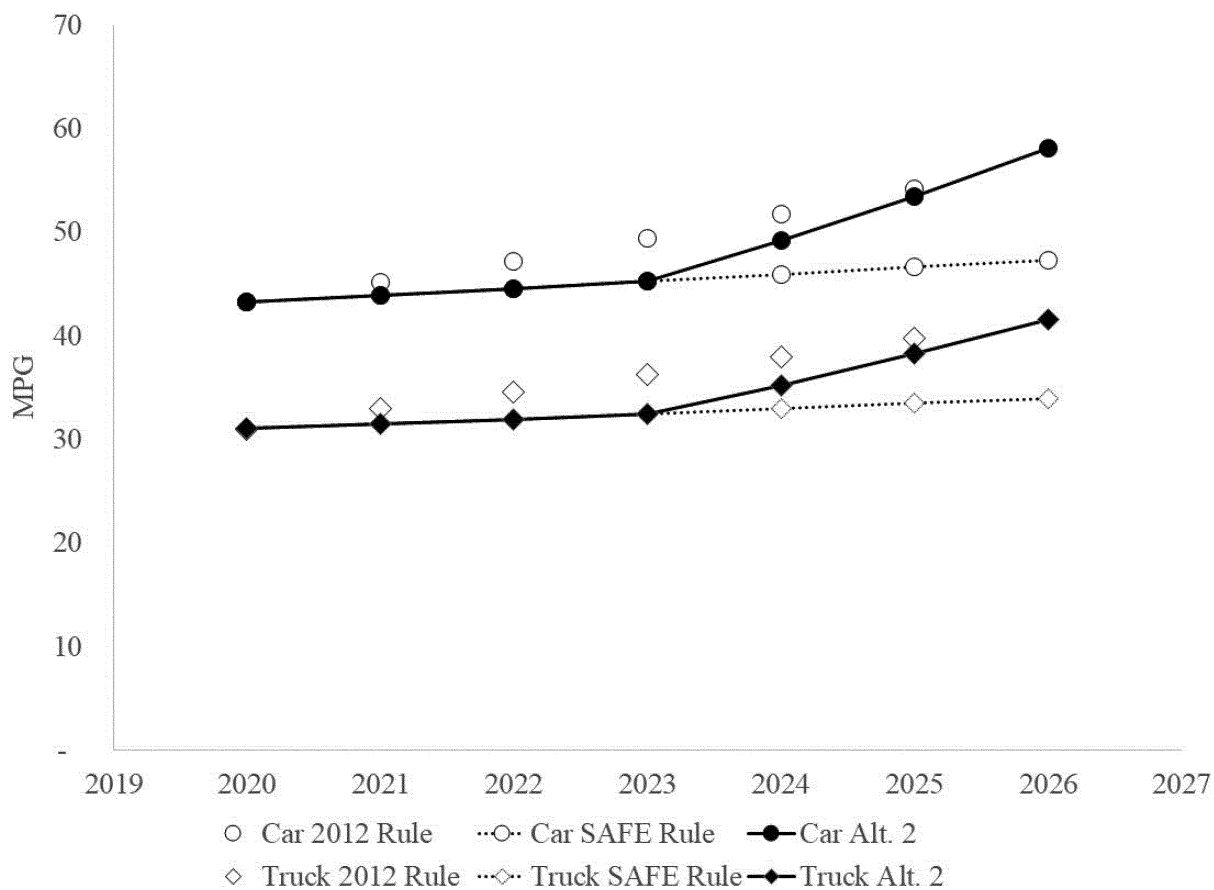

Figure VI-4 – Estimated Average Required CAFE Levels (Alternative 2)

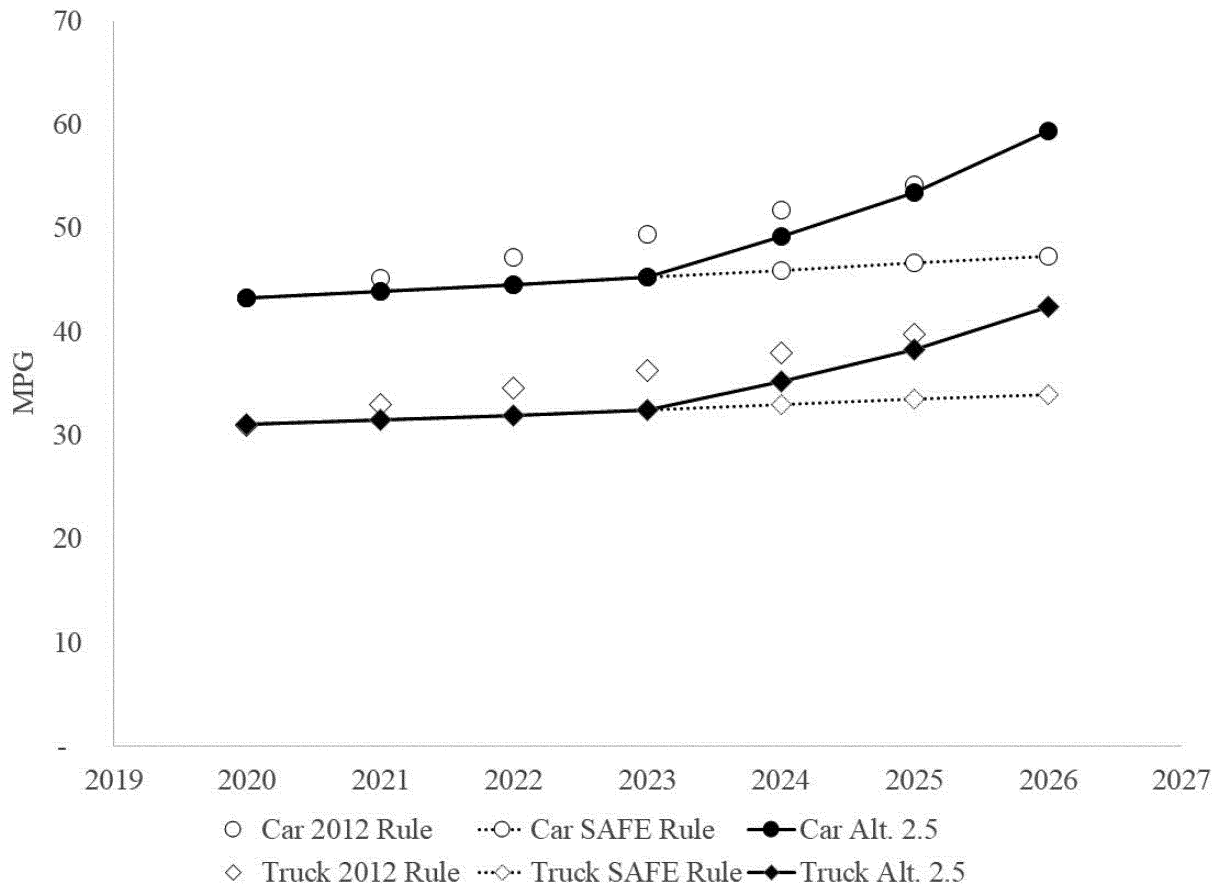

Figure VI-5 – Estimated Average Required CAFE Levels (Alternative 2.5)

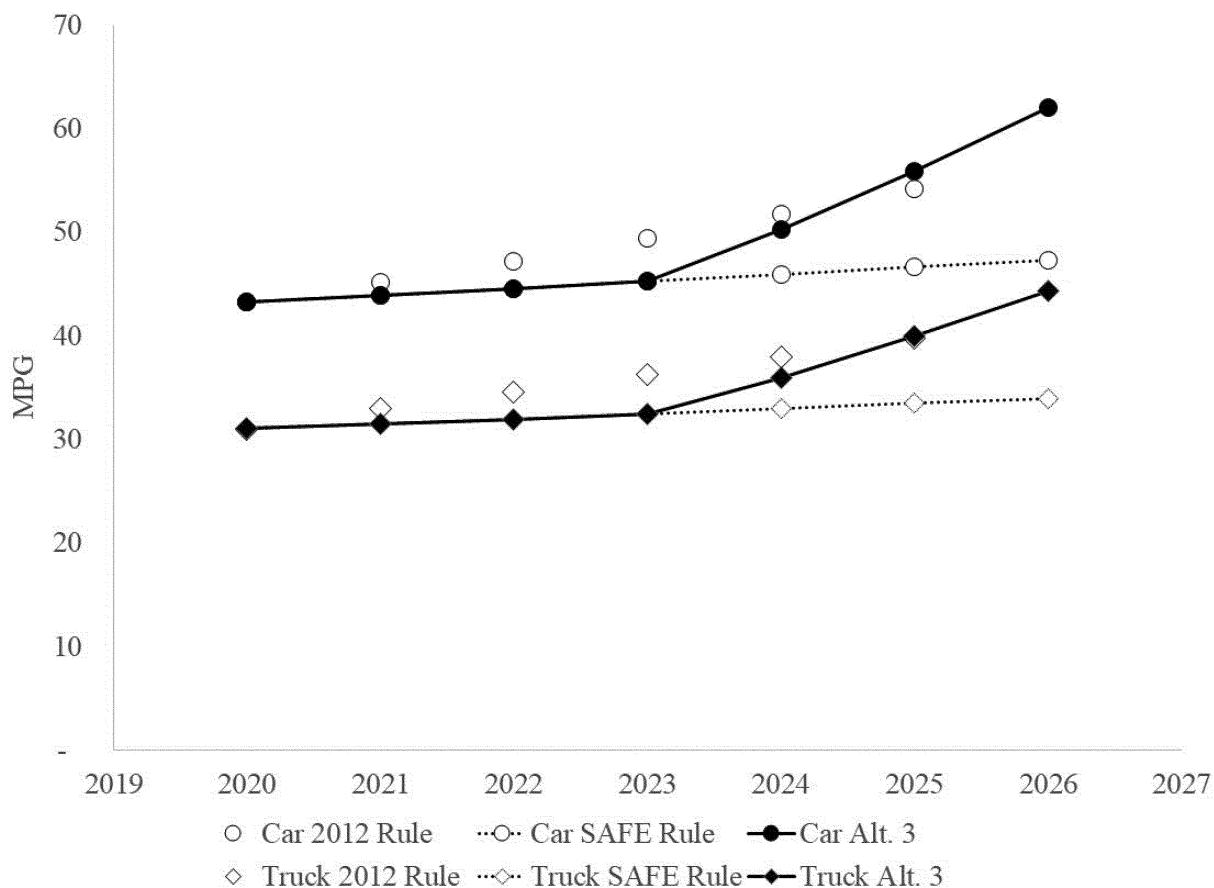

Figure VI-6 – Estimated Average Required CAFE Levels (Alternative 3)

If manufacturers were planning their fleets from a technology perspective to meet the 2012 targets for MY 2025, but feel that they “got off track” in compliance terms by selling larger, heavier, lower-fuel-economy vehicles over the last several model years relative to what the 2012 rule expected them to sell, then the figures above are instructive. As mentioned above, while Alternative 3 would reach parity with the 2012 targets “early”—for passenger cars and light trucks, Alternatives 2 and 2.5 actually provide slightly more lead time for trucks—Alternative 2 would reach parity with the 2012 targets “on time,” in 2025, for passenger cars, and in 2026 for light trucks, while Alternative 2.5 pushes trucks just slightly faster. Alternative 2.5 thus acknowledges industry concerns about lead time, because Alternative 2.5 provides more time to reach the 2012 targets, but also helps to reconcile those expressed concerns with evidence that companies have planned for 2012 targets and appear to be moving

voluntarily toward more stringent standards.

Many industry and other commenters objected to NHTSA suggesting in the NPRM that the California Framework Agreements or automakers’ public commitments to electrification, decarbonization, and higher fuel economy vehicles were relevant to economic practicability, as discussed in Section VI.A, and thus how NHTSA considered them in determining maximum feasible standards. Yet at the same time, many of those commenters vaunted these commitments in their comments to the NPRM, as noted above.

Manufacturers that agreed with CARB to increase their emissions performance during those model years are contractually bound to apply sufficient technology to meet those higher levels, and specifically, electrification technology which NHTSA does not model as part of its standard-setting analysis, due to the 49 U.S.C. 32902(h) restrictions for MYs 2024–2026. As noted above, however, some, though not all, of the non-electrification technology will both reduce emissions and improve

fuel economy, and is thus relevant to NHTSA’s assessment of technological feasibility and economic practicability. NHTSA interprets these agreements as binding because they are contracts, but also as evidence that the participating companies believe that applying that additional technology is practicable, because for-profit companies can reasonably be relied upon to make decisions that maximize their profit. Companies who did not agree with CARB to meet higher emission reduction targets may apply equivalent technology during MYs 2021–2023, but they, too, will get the relative “break” in CAFE obligations mentioned above, and have additional time to plan for the higher stringency increases in subsequent years. Those manufacturers can opt to employ more modest technologies to improve fuel economy (beyond their legal requirements) to be in a stronger fuel economy position heading into more challenging years, or concentrate their research and development resources on the next generation of higher fuel economy

vehicles that will be needed to meet the proposed standards in MYs 2024–2026 (and beyond), rather investing in more modest improvements in the near-term. As always, the CAFE program leaves it to automakers to determine how they wish to achieve compliance.

Changes in costs for new vehicles are not the only costs that NHTSA considers in balancing the statutory factors—fuel costs for consumers are

relevant to the need of the United States to conserve energy, and NHTSA believes that consumers themselves weigh expected fuel savings against increases in purchase price for vehicles with higher fuel economy. Fuel costs (or savings) continue to be the largest source of benefits for CAFE standards, and GHG reduction benefits, which are also part of the need of the U.S. to conserve energy, are also increasing.

E.O. 12866 and Circular A–4 also direct agencies to consider maximizing net benefits in rulemakings whenever possible and consistent with applicable law. Thus, because it can be relevant to balancing the statutory factors and because it is directed by E.O. 12866 and OMB guidance, NHTSA also considers the net benefits attributable to the different regulatory alternatives, as shown in Table VI–20.

Table VI-20 – Summary of Cumulative Benefits and Costs for Model Years through MY 2029, by Alternative and Discount Rate

Alternative	3% Discount Rate			7% Discount Rate		
	Costs	Benefits	Net Benefits	Costs	Benefits	Net Benefits
Alternative 1	58.6	79.2	20.6	43.0	54.5	11.5
Alternative 2	113.9	129.4	15.5	84.9	89.3	4.3
Alternative 2.5	128.4	144.6	16.3	95.8	99.7	3.9
Alternative 3	165.8	182.2	16.4	124.3	125.8	1.5

BILLING CODE 4910–59–C

Section VI.A discussed a number of comments received on net benefits and whether it was a valid consideration in determining maximum feasible standards, along with the agency’s response. South Coast AQMD argued that it was unreasonable for NHTSA to balance the factors in the NPRM by stating that “it is reasonable to consider choosing the regulatory alternative that produces the largest reduction in fuel consumption, while remaining net beneficial,” because that approach elevated economic practicability as the decisive factor and rested on a cost-benefit analysis that “is riddled with uncertainty.”¹¹³⁵ Mr. Douglas also argued that NHTSA relied too heavily in the proposal on its cost-benefit analysis and quantitative approaches, “which attempt to determine the maximum feasible level of stringency by focusing almost exclusively on the precise extent of technological and economic barriers,”¹¹³⁶ and stated that “cost-benefit analysis is a useless quantitative approach unless we assign an extraordinarily high value to the social cost of carbon,” because otherwise too little value is placed on “unquantifiable, extraordinarily precious benefits that are the fundamental goals of environmental preservation”¹¹³⁷ AFPM also argued with the validity of the cost-benefit analysis, but by noting

that if fuel prices were overstated, it could “entirely negate the stated \$1 billion net benefit,” and that “minor changes to [fuel prices, vehicle miles traveled, scrappage rate, and/or the social cost of carbon] could push the Proposal from a small net benefit to a large net cost.”¹¹³⁸ Other commenters suggested that analytical changes (that would lead to changes in the point at which net benefits were maximized) would make it clear in the final rule that Alternative 3 was net beneficial and therefore maximum feasible.¹¹³⁹

While maximizing net benefits is a valid decision criterion for choosing among alternatives, provided that appropriate consideration is given to impacts that cannot be monetized, we agree it is not the only reasonable decision perspective, and that what we include in our cost-benefit analysis affects our estimates of net benefits. At the outset, we note that the net benefits for the alternatives under consideration here do not vary greatly amongst themselves, as was also the case in the 2020 final rule, particularly given the overall costs and benefits associated with those regulatory alternatives. We also note that important benefits cannot be monetized—including the full health and welfare benefits of reducing climate and other pollution, which means the

benefits estimates are underestimates. Thus, given the uncertainties associated with many aspects of this analysis, NHTSA does not rely solely on net benefit maximization, and instead considers it as one piece of information that contributes to how we balance the statutory factors, in our discretionary judgment. NHTSA recognizes that the need of the U.S. to conserve fuel weighs importantly in the overall balancing of factors, and thus believes that it is reasonable to at least consider choosing the regulatory alternative that produces the largest reduction in fuel consumption, while remaining net beneficial. Of course, the benefit-cost analysis is not the sole factor that NHTSA considers in determining the maximum feasible stringency, though it informs NHTSA’s conclusion that Alternative 2.5 is the maximum feasible stringency. While Alternative 1 produces higher net benefits, it also continues to allow fuel consumption and accompanying disbenefits that could have been avoided in a cost-beneficial manner. And while Alternative 3 achieves greater reductions in fuel consumption than Alternative 2, it shows lower net benefits under a 7 percent discount rate. Alternative 3 also, as detailed above, adds technology costs of over \$2,000 per vehicle for more manufacturers as compared to the baseline, while Alternative 2.5 has somewhat lower costs and greater lead time for the largest increase in standards for MY 2026.

¹¹³⁵ South Coast AQMD, Docket No. NHTSA–2021–0053–1477, at 6.

¹¹³⁶ Peter Douglas, Docket No. NHTSA–2021–0053–0085, at 3.

¹¹³⁷ *Id.* at 19.

¹¹³⁸ AFPM, Docket No. NHTSA–2021–0053–1530, at 16–17.

¹¹³⁹ *See, e.g.*, California Attorney General et al., Docket No. NHTSA–2021–0053–1499, at 2; CBD et al., Docket No. NHTSA–2021–0053–1572, at 1; CARB, Docket No. NHTSA–2021–0053–1521, at 2–3.

Below, NHTSA discusses the sensitivity analysis presented in the FRIA, which demonstrates the effect that different assumptions would have on the costs and benefits associated with the standards.

As also discussed in Section VI.A, NHTSA estimates that Alternative 2.5 will result in significant additional technology application while producing only a slight decline (of about 1 percent over the entire period covered by MYs 2020–2026) in new vehicle sales as compared to the No-Action Alternative, as a consequence of the higher retail prices that result from that additional technology application. NHTSA does not believe that this very minor estimated change in new vehicle sales over the period covered by the rule is a persuasive reason to choose another regulatory alternative. Similarly, the estimated labor impacts within the automotive industry provide no evidence that another alternative should be preferred, and in fact, employment increases with alternative stringency according to the final rule analysis.¹¹⁴⁰

As with any analysis of sufficient complexity, there are a number of critical assumptions here that introduce uncertainty about manufacturer compliance pathways, consumer responses to fuel economy improvements and higher vehicle prices, and future valuations of the consequences from higher CAFE standards. While NHTSA considers dozens of sensitivity cases to measure the influence of specific parametric assumptions and model relationships, only a small number of them demonstrate meaningful impacts to net benefits under the final standards.

Looking at these cases more closely, the majority of both costs and benefits that occur under the standards accrue to buyers of new cars and trucks, rather than society in general (assuming that technology costs are passed down to consumers as higher prices, as we do in our analysis). It then follows that the assumptions that exert the greatest influence over private costs and benefits also exert the greatest influence over net benefits—chief among these is the assumed trajectory of future fuel prices, specifically gasoline. NHTSA considers the “High Oil Price” and “Low Oil Price” cases from AEO 2021 as bounding cases, though they are asymmetrical (while the low case is only about 25 percent lower than the Reference case on average, the high case is almost 50 percent higher on average). The sensitivity cases suggest that fuel prices exert considerable influence on

net benefits—where higher and lower prices not only determine the dollar value of each gallon saved, but also how market demand responds to higher levels of fuel economy in vehicle offerings. For Alternative 2.5, under the low case, at 3 percent SC–GHG DR, net benefits become negative and exceed \$14 billion, but increase to almost (positive) \$60 billion in the high case (the largest increase among any sensitivity cases run for this final rule). This suggests that the net benefits resulting from this final rule are dependent upon the future price of gasoline being at least as high as the AEO 2021 Reference Case projects.

Another critical uncertainty that affects private benefits is the future cost of advanced electrification technologies, specifically batteries. These emerging technologies provide both the greatest fuel savings to new car buyers and impose the highest technology costs (at the moment). While the costs to produce large vehicle batteries have been declining, they are still expensive relative to advancements in internal combustion engines and transmissions. However, the analysis projects continued cost learning over time and shows battery electric vehicles reaching price parity with conventional vehicles in the 2030s for most market segments—after which market adoption of BEVs accelerates—although other estimates show price parity occurring sooner. Electrification is also a viable compliance strategy, as partially or fully electric vehicles benefit from generous compliance incentives that improve their estimated fuel economy relative to measured energy consumption. As such, the assumption about future battery costs has the ability to influence compliance costs to manufacturers and prices to consumers, the rate of electric vehicle adoption in the market, and thus the emissions associated with their operation. NHTSA considered two different mechanisms to affect battery costs: Higher/lower direct costs, and faster/slower cost learning rates. The two mechanisms that reduce cost (whether by faster cost learning or lower direct costs) both increase net benefits relative to the central case, though lowering initial direct costs by 20 percent had a greater effect than increasing the learning rate by 20 percent. Increasing cost (through either mechanism) by 20 percent produced a similar effect, but in the opposite direction (reducing net benefits). However, none of those cases exerted a level of influence that compares to alternative fuel price assumptions.

There is one assumption that significantly affects the analysis without

influencing the benefits and costs that accrue to new car buyers: The social cost of damages attributable to greenhouse gas emissions. The central analysis uses a SC–GHG cost based on the 3 percent discount rate for both the 3 percent and the 7 percent social discount rate cases. Of course, the magnitude of the SC–GHG estimate used affects the monetization of the benefits of reducing greenhouse gas emissions. Using the highest SC–GHG, based on the 95th percentile estimate, pushes net benefits above \$70 billion under Alternative 2.5 at a 3 percent social discount rate and to approximately \$60 billion at a 7 percent social discount rate. The 95th percentile estimate, drawn from the possible climate impact outcomes in the underlying modeling, helps decision-makers understand the value of reducing greenhouse gas emissions if the damages caused by climate change are in reality significantly higher than the “best guess” projections of those damages.

Other sensitivity cases examine inputs that have also engendered much discussion over the past several rounds of rulemaking. Varying the rebound effect, for example, from five to 15 percent around the reference case value of 10 percent resulted in net costs ranging from \$3 billion (five percent rebound) to \$12 billion (15 percent rebound). Altering the price elasticity of demand that influences the sales and scrappage responses had a similarly small effect on net benefits; a price elasticity of -0.1 produced a net cost estimate of \$2 billion, while increasing this elasticity parameter to -0.5 resulted in net costs of \$9 billion. With battery costs, despite the extensive discussion and uncertainty over these values, they do not exert a level of influence in the analysis that significantly alters the analytical findings. Regardless of net benefits, NHTSA would still conclude that Alternative 2.5 is economically practicable, based on per-vehicle costs, technology levels estimated to be required to meet the standards, and the slight additional lead time provided as compared to Alternative 3.

As also discussed in Section VI.A, many commenters raised the issue of harmonization. Many industry commenters suggested that CAFE standards would not be economically practicable, and thus would be beyond maximum feasible, if they required any technology investments beyond what EPA’s recently finalized GHG standards for MYs 2024–2026 would require. Consequently, these commenters suggested that Alternative 3 was beyond maximum feasible, and even Alternative

¹¹⁴⁰ See FRIA Chapter 6.3.3, Table 6–1.

2 was beyond maximum feasible, because its stringency was not uniformly below EPA's stringency when all EPA flexibilities and NHTSA statutory restrictions on flexibilities were accounted for.¹¹⁴¹ Some of these commenters, as described above, further argued that because Alternatives 2 and higher were "too stringent" compared to EPA's standards, that they would require application of additional electric vehicles beyond what EPA's standards would require.¹¹⁴²

These commenters also generally objected to inclusion of State ZEV standards in NHTSA's analytical baseline, as discussed in Sections IV.B and VI.A. Conversely, California Attorney General et al. argued that they did not believe that NHTSA having added California's ZEV standards in the baseline was inherently dispositive for NHTSA's determination of maximum feasible standards, because "The technological feasibility, economic practicability, and energy conservation factors . . . strongly favor NHTSA's proposed standards" already.¹¹⁴³ California Attorney General et al. noted that simply "by including California's ZEV standards in the . . . baseline, NHTSA has already demonstrated that the proposed changes to the CAFE standards and the California ZEV standards will not interfere with each other and that it is entirely feasible for automakers to comply with both."¹¹⁴⁴

In response, as discussed in Section VI.A, NHTSA has carefully considered the effect of State ZEV standards as other legal requirements facing automakers during the rulemaking time frame and agrees with California Attorney General et al. that it appears to be feasible for automakers to comply with both. NHTSA has carefully considered the EPA GHG standards, and disagrees that CAFE standards must account precisely for each and every difference between the two programs and be calculated to avoid any additional need for technology outlay whatsoever. As explained in Section VI.A, NHTSA's statutory mandate is to set maximum feasible standards, considering the four statutory factors. In considering the effect of other motor vehicle standards of the Government on fuel economy, NHTSA considers whether any of those effects affect the

maximum feasible determination. Pursuant to this directive, NHTSA has evaluated the feasibility of complying with the revised CAFE standards in the context of EPA's standards, and concluded that complying with both standards is feasible. As discussed above, even when the standards of the two programs are coordinated closely, it is still foreseeable that there could be situations in which different agencies' programs could be binding for different manufacturers in different model years. This was true for the 2012 final rule and it is true for the revised programs. Regardless of which agency's standards are binding given a manufacturer's chosen compliance path, manufacturers will choose a path that complies with both standards, and in doing so, will still be able to build a single fleet of vehicles—even if it is not exactly the fleet that the manufacturer might have preferred to build. This remains the case today.

NHTSA does not believe that it is a reasonable interpretation of Congress' direction to set "maximum feasible" standards at "the fuel economy level at which no manufacturer need ever apply any additional technology or spend any additional dollar beyond what EPA's standards, with their many flexibilities, would require." NHTSA disagrees that avoiding inconsistency with EPA's programs requires NHTSA standards to impose *zero* additional costs. Rather, NHTSA must fulfill its statutory mandate to set maximum feasible fuel economy standards. NHTSA evaluated whether it would be feasible for manufacturers complying with EPA's standards to achieve the level of fuel economy that NHTSA has identified as maximum feasible, and has determined that it is. Further, the technological improvements to which automakers have committed in the coming years will, no doubt, facilitate their compliance with CAFE standards, even if they are not credited as heavily as in the GHG program.

NHTSA interprets "maximum feasible" instead, as it has done previously, as requiring a balancing of the relevant factors, rather than letting a single factor drive the decision entirely. The purpose of EPCA is energy conservation, and NHTSA is interpreting the need to conserve energy to be largely driven by fuel savings, energy security, and environmental concerns. Therefore, it makes sense to interpret EPCA's factors as asking the agency to push stringency as far as possible before it appears that standards may not be economically practicable or technologically feasible. NHTSA is also directed by statute to consider "other

motor vehicle standards of the Government" and their effect on fuel economy in assessing what is maximum feasible. If compliance with other motor vehicle standards of the Government made certain fuel economy-improving technologies infeasible or less effective, for example, then NHTSA would be obligated to take that into account in determining what CAFE standards were maximum feasible. NHTSA has conducted the required weighing of the statutory factors, and in doing so the agency has concluded that Alternative 2.5 is maximum feasible. In drawing this conclusion, NHTSA has considered other motor vehicle standards of the Government and concluded they will not make compliance with Alternative 2.5 infeasible.

Thus, again, in re-evaluating all of the factors that NHTSA considers in determining maximum feasible CAFE standards, the agency was compelled to balance what we believe is a credible case for choosing Alternative 3 as opposed to Alternative 2.5. In doing so, NHTSA must balance the four statutory factors. Alternative 2.5 and Alternative 3 each produce significant reductions in fuel use, and while Alternative 3 is estimated to result in more savings, it could require technology application well beyond what EPA's GHG standards and State ZEV standards will require. Alternative 3 is less economically practicable for the model years addressed by this rule, when considering per-vehicle costs, technology application rates, and lead time. Even though Alternative 3 maximizes energy conservation, and NHTSA believes it is technologically feasible, economic practicability tips the balance for the agency to Alternative 2.5. Alternative 2.5 is an aggressive but achievable set of standards that NHTSA has concluded represents the right balancing for MYs 2024–2026—it is technologically feasible; and it continues to push fuel economy improvements, bolstering the industry's trajectory toward higher future standards by keeping stringency high in the mid-term. It meets the need of the U.S. to conserve energy, but in our estimation, not beyond the point of economic practicability; and we believe that it is complementary to other motor vehicle standards of the Government and feasible to achieve in the context of those other standards. For these reasons, NHTSA concludes that Alternative 2.5 is maximum feasible for MYs 2024–2026.

¹¹⁴¹ See, e.g., Auto Innovators, Docket No. NHTSA–2021–0053–1492, at 15, 32, 51; Stellantis, Docket No. NHTSA–2021–0053–1527, at 2; Hyundai, Docket No. NHTSA–2021–0053–1512, at 5–6; Mercedes-Benz, Docket No. NHTSA–2021–0053–0952, at 3; AVE, Docket No. NHTSA–2021–0053–1488–A1, at 3.

¹¹⁴² See, e.g., Stellantis, Docket No. NHTSA–2021–0053–1527, at 3.

VII. Compliance and Enforcement

A. Complying With the NHTSA CAFE Program

1. Overview

NHTSA's CAFE enforcement program is largely established by statute, EPCA, as amended by EISA, and is very prescriptive with regard to enforcement. EPCA and EISA also clearly specify a number of flexibilities that are available to manufacturers to help them comply with the CAFE standards. Some of those flexibilities are constrained by statute—for example, while Congress required that NHTSA allow manufacturers to transfer credits earned for over-compliance from their car fleet to their truck fleet and vice versa, Congress also limited the amount by which manufacturers could increase their CAFE levels using those transfers. NHTSA believes Congress balanced the energy-saving purposes of the statute against the benefits of certain flexibilities and incentives and intentionally placed some limits on certain statutory flexibilities and incentives. With that goal in mind, of maximizing compliance flexibility while also implementing EPCA/EISA's overarching purpose of energy conservation as fully as possible, NHTSA has crafted the credit transfer and trading regulations authorized by EISA to ensure that total fuel savings are preserved when manufacturers exercise their statutorily provided compliance flexibilities.

In addition, NHTSA and EPA have previously developed other compliance flexibilities and incentives for the CAFE program consistent with the statutory provisions regarding EPA's calculation of manufacturers' fuel economy levels. As discussed in the following sections, NHTSA is finalizing requirements for this final rule under EPA's program to be applied as fuel economy "adjustments" or "improvement values" for the CAFE program. These include: (1) Technologies that cannot be measured or cannot be fully measured on the 2-cycle test procedure, *i.e.*, "off-cycle" technologies; (2) AC efficiency improvements that also improve fuel economy but cannot be measured on the 2-cycle test procedure, and; (3) full-size pickup trucks, such as hybridization, or full-size pickup trucks that overperform their fuel economy stringency target values by greater than a specified amount. More specifically, NHTSA is

finalizing incentives in these areas increasing the benefits manufacturers can claim for off-cycle menu technologies from 10 g/mile to 15 g/mile and adding definitions for technologies on the menu. Also, NHTSA is reinstating previously deleted compliance incentives for advance full sized pickup trucks to start again in MY 2023, and extend through MY 2024. In addition, NHTSA is also finalizing several administrative processes to its off-cycle program including deadlines and greater oversight to ensure timely accounting of these incentives for CAFE compliance. Finally, NHTSA is providing clarifications to its criteria for classifying light trucks in the CAFE program to be added to its upcoming compliance test procedure.

To help explain how the compliance changes being finalized affect the CAFE program, the following sections outline how NHTSA determines how manufacturers comply with CAFE standards for each model year, and how manufacturers may use compliance flexibilities, or alternatively, address noncompliance through civil penalties. Moreover, it explains how manufacturers submit data and information to the agency for compliance purposes. This includes a detailed discussion of NHTSA's standardized CAFE reporting and credit transactions templates and its requirements for manufacturers to provide information and the documentation associated with credit trades. These reporting templates and requirements were adopted as a part of the 2020 final rule and revised in the proposals for the 2021 NPRM.¹¹⁴⁵ In this rulemaking, NHTSA is finalizing the changes to its reporting and credit templates and issuing a new template to clarify the required costing information for credit trades. These new requirements are intended to streamline reporting and data collection from manufacturers, in addition to helping the agency use the best available data to inform CAFE program decision makers for future rulemakings, and when considering additional or revised flexibilities and incentives.

2. Light Duty CAFE Compliance Data for MYs 2011–2021

As the first step to understanding compliance with the CAFE program,

¹¹⁴⁵ 86 FR 49602 (Sept. 3, 2021).

NHTSA receives CAFE reports from manufacturers and evaluates the information in these reports. NHTSA uses compliance data in part to identify industry trends for policy makers as discussed above, then to conduct verification testing and audits and finally to provide aggregated reporting to uphold its commitment for public transparency. For this final rule, NHTSA is releasing aggregated CAFE compliance data for model years 2011 through 2021 using final compliance data for MYs 2011 through 2017,¹¹⁴⁶ projections from end-of-the-model year reports submitted by manufacturers for MYs 2018 and 2019,¹¹⁴⁷ and projections from manufacturers' mid model year reports for MY 2020 and 2021.¹¹⁴⁸ Projections from the mid-year and end-of-the-model year reports may differ from EPA-verified final CAFE values either because of differing test results or final sales-volume figures. MY 2011 was selected as the start of the data because it represents the first compliance model year for which manufacturers were permitted to trade and transfer credits.¹¹⁴⁹ The data go up to MY 2021, because this was the most recent year compliance reports have been accessed for their completeness. Figure VII–1 through Figure VII–4 provide a graphical overview of the actual and projected compliance data for MYs 2011–2021.¹¹⁵⁰

In the figures, an overview is provided for the total fuel economy performance of the industry (the combination of all passenger cars and light trucks produced for sale during the model year) as a single fleet, and for each of the three CAFE compliance fleets: Domestic passenger car, import passenger car, and light truck fleets.

¹¹⁴⁶ Final compliance data have been verified by EPA and are published on the NHTSA's Public Information Center (PIC) site. MY 2017 is currently the most-recent model year verified by EPA.

¹¹⁴⁷ MY 2018 data come from information received in manufacturers' final reports submitted to EPA according to 40 CFR 600.512–12.

¹¹⁴⁸ Manufacturers' mid-model year CAFE reports are submitted to NHTSA in accordance with 49 CFR part 537. At the time of the analysis, end of the model year data had not yet been submitted for MY 2020 or 2021.

¹¹⁴⁹ 49 CFR 535.6(c).

¹¹⁵⁰ As mentioned previously, the figures include estimated values for certain model years based on the most up to date information provided to NHTSA from manufacturers.

For each of the graphs, a sale-production weighting is applied to determine the average total or fleet Base CAFE performances.^{1151 1152 1153} The graphs do not include adjustments for full-size pickup trucks because manufacturers have yet to reach the required market threshold to utilize the incentive.

The figures also show how many credits remain in the market each model year. One complicating factor for presenting credits is that the mpg-value of a credit is contingent where it was earned and applied. Therefore, the actual use of the credits for MY 2018 and beyond will be uncertain until compliance for those model years is completed. Also, since credits can be retained for up to six model years after

¹¹⁵¹ In the figures, the label “2-Cycle CAFE” represents the maximum increase each year in the average fuel economy set to the limitation “cap” for manufacturers attributable to dual-fueled automobiles as prescribed in 49 U.S.C. 32906. The label “AC/OC contribution” represents the increase in the average fuel economy adjusted for AC and off-cycle FCIVs as prescribed by 40 CFR 600.510–12.

¹¹⁵² Consistent with applicable law, NHTSA established provisions starting in MY 2017 allowing manufacturers to increase compliance performance based on fuel consumption benefits gained by technologies not accounted for during normal 2-cycle EPA compliance testing (called “off-cycle technologies” for technologies such as stop-start systems) as well as for AC systems with improved efficiencies and for hybrid or electric full-size pickup trucks.

¹¹⁵³ Adjustments for earned credits include those that have been adjusted for fuel saving using the manufacturers CAFE values for the model years in which they were earned and adjusted to the average CAFE values for the fleets they exist within.

they were earned or applied retroactively to the previous 3 model years, it is impossible to know the final application of credits for MY 2020 until MY 2023 compliance data are finalized. Instead of attempting to project how credits would be generated and used, the agency opted to value each credit based on its actual value when earned, by estimating the value when applied assuming it was applied to the overall average fleet and across all vehicles. In the figures, two different approaches were used to represent the mpg value of credits used to offset shortages (shown as CAFE after credit allocation in the figures). The mpg shortages for MYs 2011–2017 are based upon actual compliance values from EPA and the credit allocations or fines manufacturers instructed NHTSA to adjust and apply to resolve compliance shortages. For MYs 2018–2021, NHTSA used a different approach for representing the mpg shortages, deriving them from projected estimates adjusted for fuel savings calculated from the projected fleet average performances and standards for each model year and fleet. To represent the mpg value of manufacturers’ remaining banked credits in the figures (shown as Credits in the Market) the same weighting approach was also applied to these credits based upon the fleet averages. For MYs 2011–2017, the remaining banked credits include those currently existing in manufacturers’ credit accounts adjusted for fuel savings and subtracting any expired credits for each year. This approach was taken to

represent these credits for the actual value that would likely exist if the credits were applied for compliance purposes. Without adjusting the banked credits, our analysis would provide an unrealistic value of the true worth of these credits when used for compliance. For MYs 2018–2021, the mpg value of the remaining banked credits is shown slightly differently where the value represents the difference between the adjusted credits carried forward from previous model years (minus expiring credits) and the projected earned credits minus any expected credit shortages. Since all the credits in these model years were adjusted using the same approach it was possible to subtract the credit amounts. However, readers are reminded that for MYs 2018–2021 since the final CAFE reports have yet to be issued, the credit allocation process has not started, and the data shown in the graphs are a projection of potential overall compliance. Consequently, the credits included for MYs 2018–2021 are separated from earlier model years by a dashed line to highlight that there is a margin of uncertainty in the estimated values. Projecting how and where credits will be used is difficult for a number of reasons, such as not knowing which flexibilities manufacturers will utilize and the fact that credits are not valued the same across different fleets. As such, the agency reminds readers that the projections may not align with how manufacturers will actually approach compliance for these years.

BILLING CODE 4910–59–P

Total Fleet Compliance

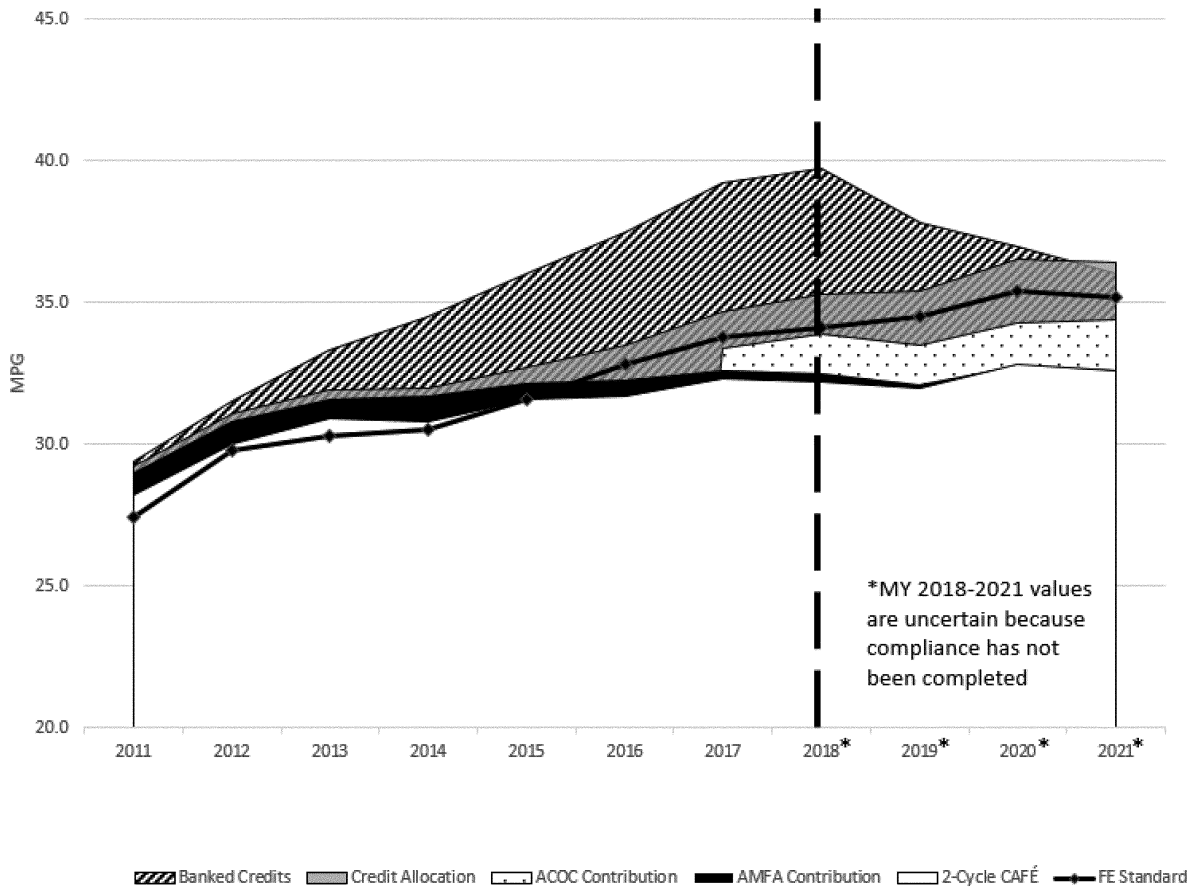

Figure VII-1 – Total Fleet Compliance Overview for MYs 2011 to 2021

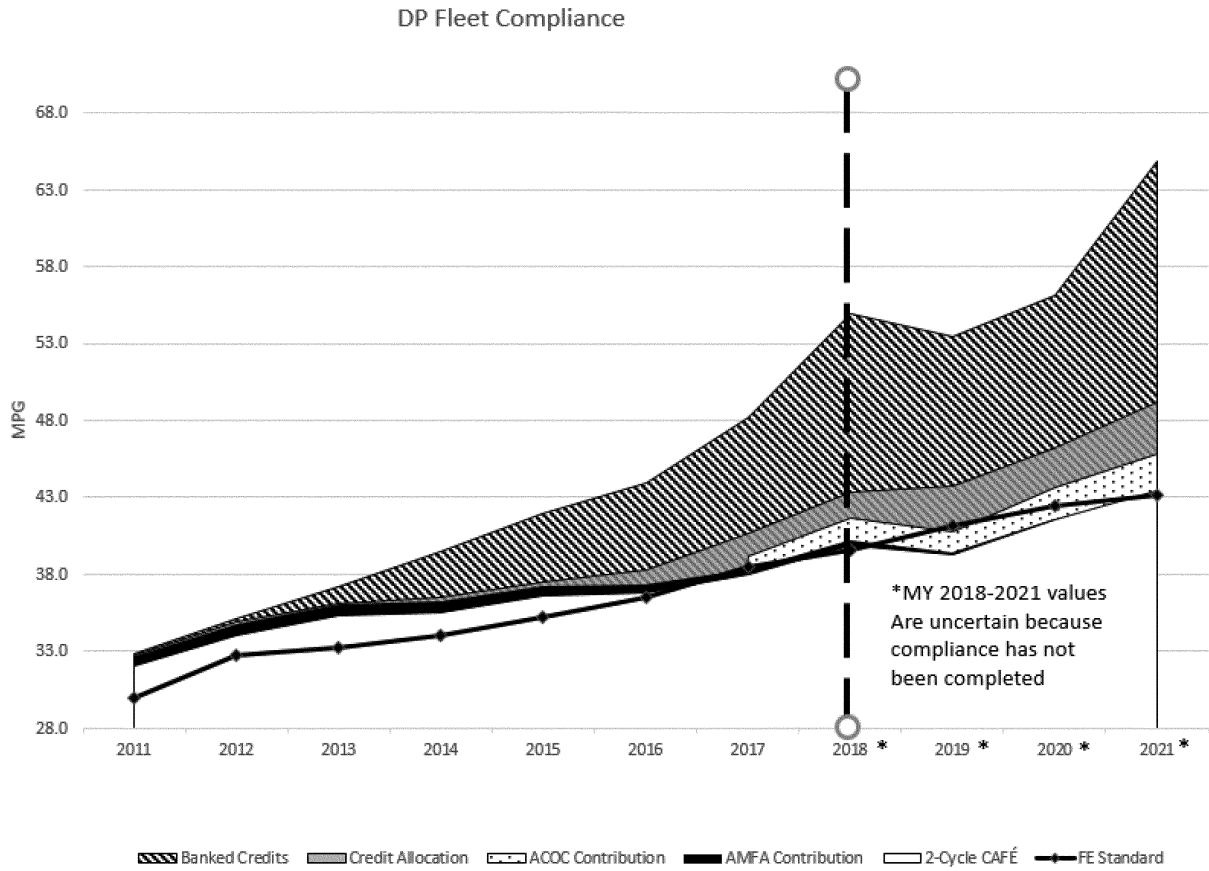

Figure VII-2 – Domestic Passenger Car Compliance Overview for MYs 2011 to 2021

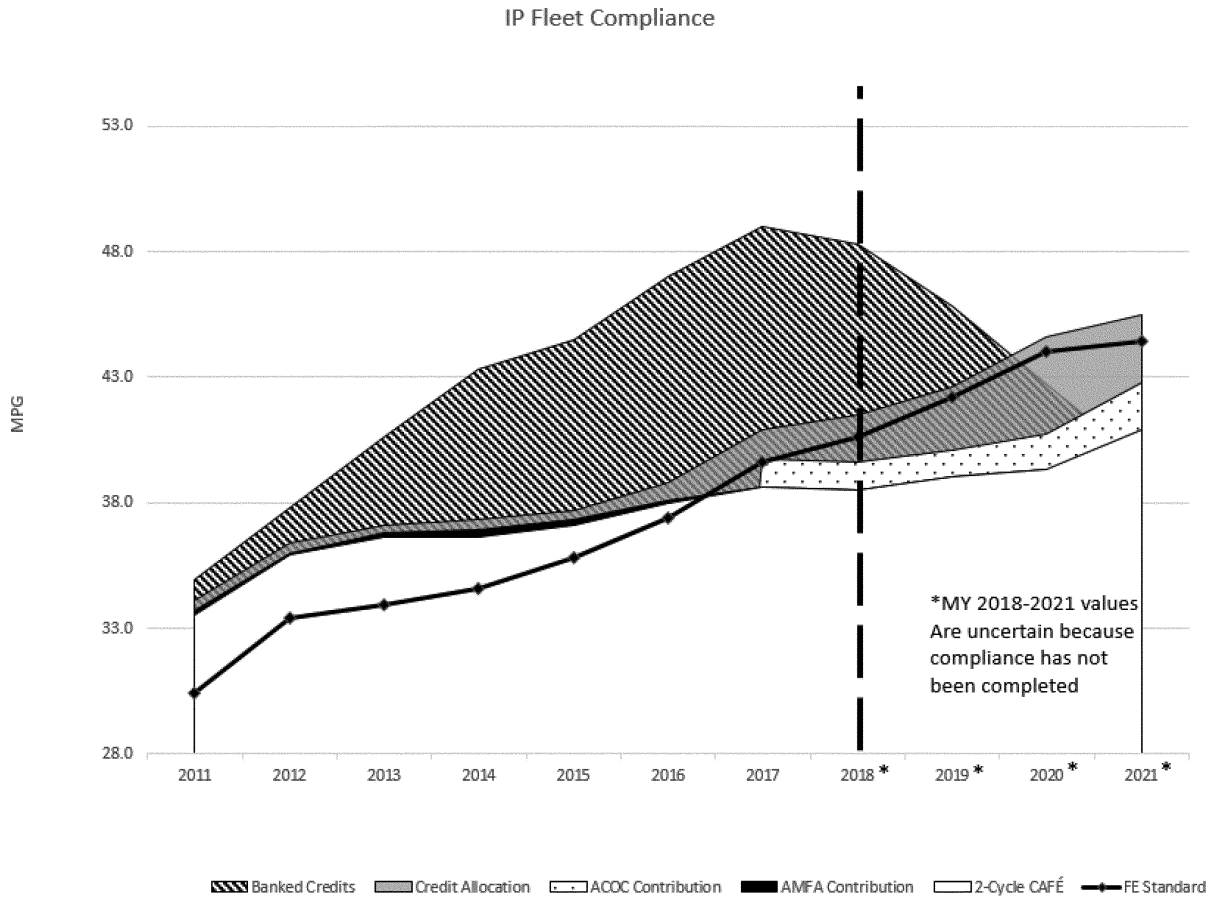

Figure VII-3 – Import Passenger Car Compliance Overview for MYs 2011 to 2021

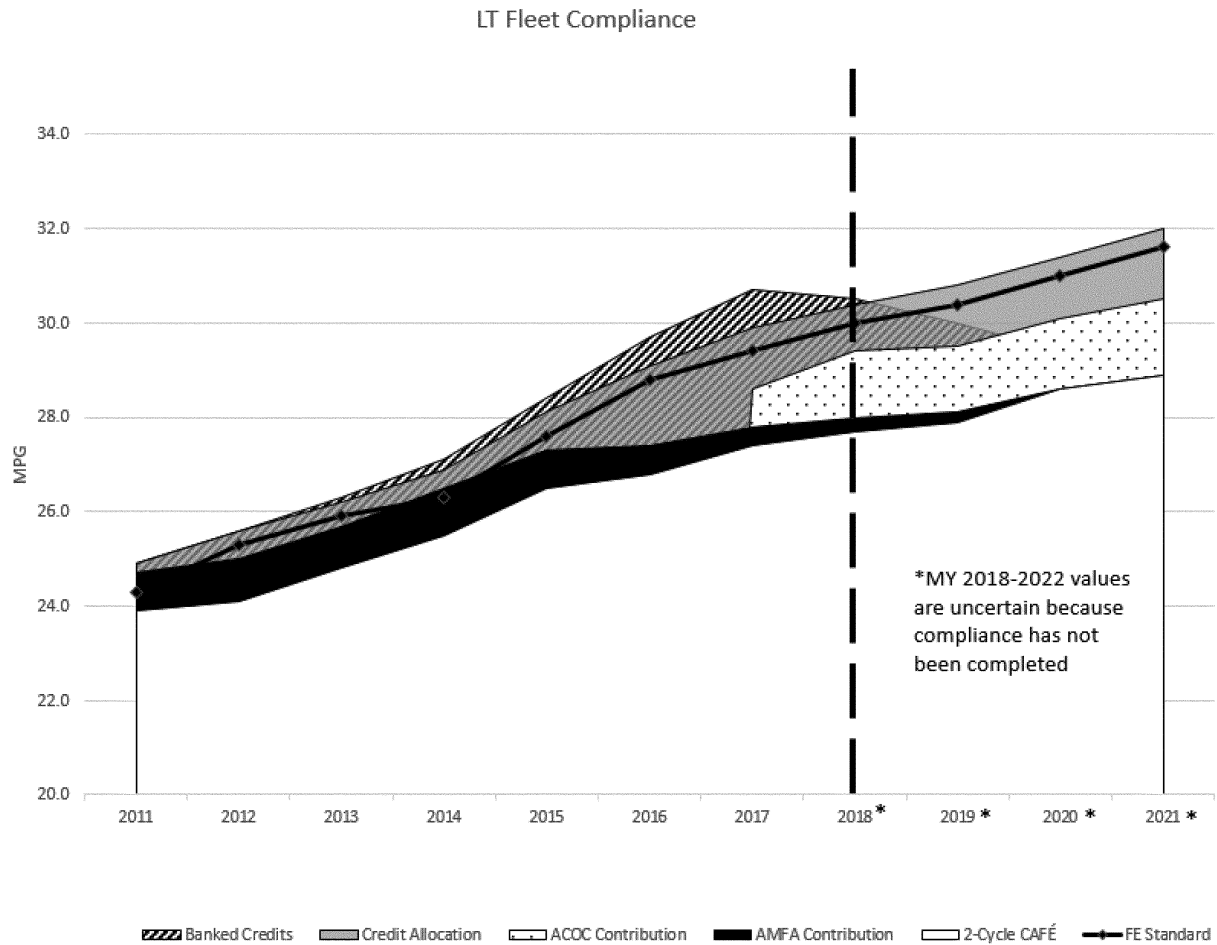

Figure VII-4 – Light Truck Compliance Overview for MYs 2011 to 2021

Table VII-1 – CAFE Performance and Standards for MYs 2011 to 2021

Model Year	Domestic Passenger Car		Import Passenger Car		Light Truck		Total Fleet	
	CAFE (mpg)	Standard (mpg)	CAFE (mpg)	Standard (mpg)	CAFE (mpg)	Standard (mpg)	CAFE (mpg)	Standard (mpg)
2021	45.8	43.1	42.8	44.4	30.5	31.6	34.4	35.2
2020	43.6	42.4	40.7	44	30.1	31	34.3	35.4
2019	40.8	41.2	40.1	42.2	29.5	30.4	33.5	34.5
2018	41.7	39.6	39.6	40.6	29.4	30	33.9	34.1
2017	39.2	38.5	39.7	39.6	28.6	29.4	33.4	33.8
2016	37.3	36.5	38.1	37.4	27.4	28.8	32.3	32.8
2015	37.2	35.2	37.3	35.8	27.3	27.6	32.2	31.6
2014	36.3	34	36.9	34.6	26.5	26.3	31.7	30.5
2013	36.1	33.2	36.8	33.9	25.7	25.9	31.6	30.3
2012	34.8	32.7	36	33.4	25	25.3	30.8	29.8
2011	32.7	30	33.7	30.4	24.7	24.3	29	27.4

BILLING CODE 4910-59-C

Table VII-1 provides the numerical CAFE performance values and standards for MYs 2011–2021 as shown in the figures.

As shown in Figure VII-1, manufacturers' fuel economy performance (2-cycle CAFE plus AMFA) for the total fleet was better than the fleet-wide target through MY 2015. On average, the total fleet exceeded the standards by approximately 0.9 mpg for MYs 2011 to 2015. As shown in Figure VII-2 through Figure VII-4, domestic and import passenger cars exceeded standards on average by 2.1 mpg and 2.3 mpg, respectively. By contrast, light truck manufacturers on average fell below the standards by 0.3 mpg over the same time period.

For MYs 2016 through 2021, Figure VII-1 shows that the total fleet Base CAFE (including 2-Cycle CAFE plus AC and OC benefits) falls below and appears to remain below the fleet CAFE standards for these model years.¹¹⁵⁴ The projected compliance shortfall (*i.e.*, the difference between CAFE performance values and the standards) remains constant and reaches its greatest difference between MYs 2019 and 2021. Compliance becomes even more complex when observing individual compliance fleets over these years. Only domestic passenger car fleets collectively appear to exceed CAFE standards while import passenger car fleets appear to have the greatest compliance shortages. In MY 2020, the import passenger car fleet appear to reach its highest compliance shortfall equal to 3.9 mpg.

The graphs provide an overall representation of the average values for each fleet, although they are less helpful for evaluating compliance with the minimum domestic passenger car standards given statutory prohibitions on manufacturers using traded or transferred credits to meet those standards.¹¹⁵⁵ NHTSA notes that several manufacturers have already reported insufficient earned credits and may have to make fine payments if they fail to reach the minimum domestic passenger car standards.

In summary, MY 2016 is the last compliance model year that passenger cars complied with CAFE standards

relying solely on Base CAFE performance. Prior to this timeframe, passenger car manufacturers especially those building domestic fleets could and did exceed CAFE standards. MY 2016 marked the first time in the history of the CAFE program where compliance for passenger car manufacturers fell below standards thereby increasing shortfalls and forcing manufacturers to rely heavily upon credit flexibilities. Despite higher shortfalls, domestic passenger car manufacturers have continued to generate credits and increase their total credit holdings. The projections show that for MYs 2018–2021, domestic passenger car fleets will transition from generating to using credits but will maintain sizable amounts of banked credits sufficient to sustain compliance shortfalls in other regulatory fleets within statutory requirements. Figure VII-3 shows residual available banked credits even as far as MY 2021. Domestic passenger car credits and their off-cycle credits will play an important role in sustaining manufacturers in complying with CAFE standards.

From the projections, it appears that based on the number of remaining domestic passenger credits in the market and the rate at which they are being used, there will be insufficient credits to cover the shortfalls in other compliance fleets in years following MY 2020. Figure VII-1 shows that the total remaining combined credits for the industry is expected to decline starting in MY 2018. Import passenger cars and light truck fleets will play a major role in the decline and possible depletion of all available credits to resolve shortfalls after MY 2020. Several factors exist that could produce this outcome. First, increasing credit shortages are occurring in the import passenger car and light truck fleets especially since the reduction and then termination of AMFA incentives in MY 2019 (a major contributor for light trucks). Next, residual banked credits for the light truck fleet are expected to be exhausted starting in MY 2018 and for import passenger cars in MY 2020. Finally, the use of AC/OC benefits for import passenger cars and light trucks is not a significant factor for these fleets in complying with CAFE standards. Manufacturers will need to change their production strategies or introduce substantially more fuel saving technologies to sustain compliance in the future.

Figure VII-5 provides a historical overview of the industry's use of CAFE credit flexibilities and fine payments for

addressing compliance shortfalls.¹¹⁵⁶ As mentioned, MY 2017 is the last model year for which CAFE compliance determinations are completed, and credit application and civil penalty payment determinations finalized. As shown in the figure, for MYs 2011–2015, manufacturers generally resolved credit shortfalls by carrying forward earned credits from previous years. However, since 2011, the rise in manufacturers executing credit trades has become increasingly common and, in MY 2017, credit trades were the most frequently used flexibility for achieving compliance. Credit transfers have also become increasingly more prevalent for manufacturers. As a note to readers, credit trades in the figures can also involve credit transfers but are aggregated in the figure as credit trades to simplify results. In MY 2016, credit transfers constituted the highest contributor to credit flexibilities but are starting to decline, signifying that manufacturers are currently exhausting credit transfers within their own fleets. Manufacturers only occasionally carry back credits to resolve performance shortfalls. NHTSA believes that trading credits between manufacturers and to some degree transferring traded credit across fleets will be the most commonly used flexibility in complying with future CAFE standards as started in MY 2017.

Credit trading has generally replaced civil penalty payments as a compliance mechanism. Only a handful of manufacturers have made civil penalty payments since the implementation of the credit trading program. As previously shown, NHTSA believes that manufacturers have sufficient credits to resolve any import passenger car and light truck performance shortfalls expected through MY 2020. There were two fine payments made in MY 2016 and 2017 which fit this exact case. By statute, manufacturers cannot use traded or transferred credits to address performance shortfalls for failing to meet the minimum domestic passenger car standards. Because of this limitation, the fine payments made in MY 2016 and 2017 came from one manufacturer that had exhausted all of its earned domestic passenger credits and could not carryback future credits. NHTSA calculates that there will be 11 instances of MDPCS between 2018 and 2021 where substantial civil penalty payments will have to be made.

¹¹⁵⁶ Figure VII-5 includes all credits manufacturers have used in credit transactions to date. Credits contained in carryback plans yet to be executed or in pending enforcement actions are not included in Figure VII-5.

¹¹⁵⁴ Until MY 2023 compliance, the last year where earned credits can be retroactively applied to MY 2020, NHTSA will be unable to make a determination about the fleet's overall compliance over this timespan.

¹¹⁵⁵ In accordance with 49 CFR 536.9(c), transferred or traded credits may not be used, pursuant to 49 U.S.C. 32903(g)(4) and (f)(2), to meet the domestically manufactured passenger automobile minimum standard specified in 49 U.S.C. 32902(b)(4) and in 49 CFR 531.5(d).

In Figure VII-6, additional information is provided on the credit flexibilities exercised and fine payments made by manufacturers for MYs 2011-2017. The figure includes the GGE for these credit flexibilities or for paying civil penalties. The figure shows that

manufacturers used carrying forward credits most often to resolve shortfalls. Credit trades were the second leading benefit to manufacturers in using credit flexibilities and then followed by credit transfers. In summary, manufacturers used these flexibilities amounting to the

equivalent of 2,952,856 gallons of fuel by carrying forward credits in 2017 and 583,720 gallons of fuel by trading credits in 2017.

BILLING CODE 4910-59-P

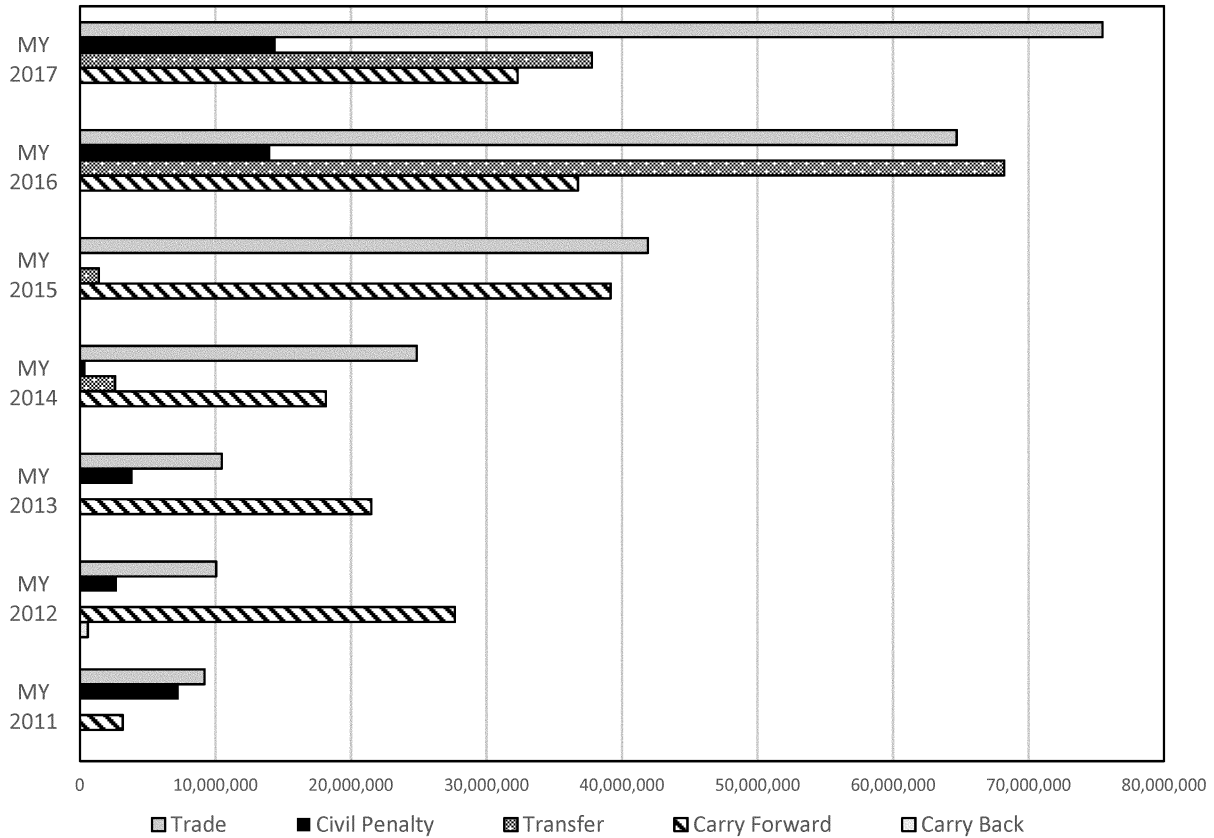

Figure VII-5 – Industry Use of Compliance Flexibilities and Civil Penalty Payments¹¹⁵⁷

¹¹⁵⁷ For Figure VII-6; in each year, some flexibilities were not utilized by manufacturers. For example, carry backed credits were not utilized in 2011, 2013, 2014, 2015, 2016, or 2017. Transfer credits were not used in 2011, 2012 or 2013. No civil penalties were paid in 2015.

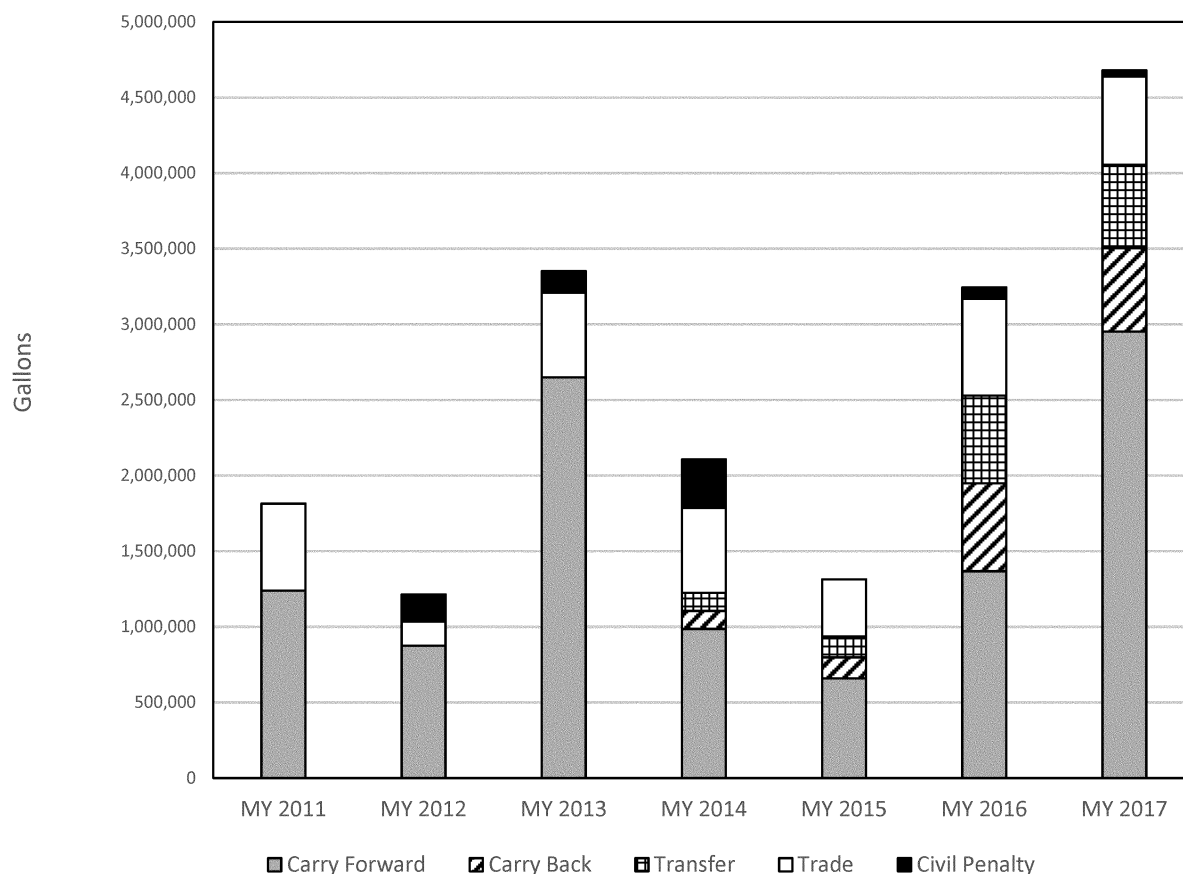

Figure VII-6 – Value of Applied Credit Flexibilities and Civil Penalty Payments in Gallons

BILLING CODE 4910-59-C

(a) Manufacturers Reports to NHTSA

EPCA, as amended by EISA, in 49 U.S.C. 32907, requires manufacturers to submit projections reports to the Secretary of Transportation explaining how they will comply with the CAFE standards in advance of the model year for which the report is made; the actions a manufacturer has taken or intends to take to comply with the standard; and other information the Secretary requires by regulation.¹¹⁵⁸ A manufacturer must submit a report containing this information during the 30-day period before the beginning of each model year, and during the 30-day period beginning the 180th day of the model year.¹¹⁵⁹ When a manufacturer determines it is unlikely to comply with a CAFE standard, the manufacturer must report additional actions it intends to take to comply and include a statement about whether those actions are sufficient to ensure compliance.¹¹⁶⁰

To implement these reporting requirements, NHTSA issued 49 CFR part 537, “Automotive Fuel Economy Reports,” which specifies three types of CAFE reports that manufacturers must submit.¹¹⁶¹ A manufacturer must first submit a pre-model year (PMY) report containing the manufacturer’s projected compliance information for that upcoming model year. By regulation, the PMY report must be submitted in December of the calendar year prior to the corresponding model year.¹¹⁶² Manufacturers must then submit a mid-model year (MMY) report containing updated information from manufacturers based upon actual and projected information known midway through the model year. By regulation, the MMY report must be submitted by the end of July for the applicable model year.¹¹⁶³ Finally, manufacturers must submit a supplementary report to supplement or correct previously submitted information, as specified in NHTSA’s regulation.¹¹⁶⁴

If a manufacturer wishes to request confidential treatment for a CAFE report, it must submit both a confidential and redacted version of the report to NHTSA. CAFE reports submitted to NHTSA contain estimated sales production information, which may be protected as confidential until the termination of the production period for that model year.¹¹⁶⁵ NHTSA protects each manufacturer’s competitive sales production strategies for 12 months, but does not permanently exclude sales production information from public disclosure. Sales production volumes are part of the information NHTSA routinely makes publicly available through the CAFE PIC.

The manufacturer reports provide information on light-duty automobiles such as projected and actual fuel economy standards, fuel economy performance, and production volumes, as well as information on vehicle design features (e.g., engine displacement and transmission class) and other vehicle attribute characteristics (e.g., track width, wheelbase, and other off-road features for light trucks). Beginning with

¹¹⁵⁸ 49 U.S.C. 32907(a).

¹¹⁵⁹ *Id.*

¹¹⁶⁰ *Id.*

¹¹⁶¹ See 47 FR 34986 (Aug. 12, 1982).

¹¹⁶² 49 CFR 537.5(b).

¹¹⁶³ *Id.*

¹¹⁶⁴ 49 CFR 537.8.

¹¹⁶⁵ 49 CFR part 512, appx. B(2).

MY 2017, to obtain credit for fuel economy improvement values attributable to additional technologies, manufacturers must also provide information regarding AC systems with improved efficiency, off-cycle technologies (e.g., stop-start systems, high-efficiency lighting, active engine warm-up), and full-size pickup trucks with hybrid technologies or with fuel economy performance that is better than footprint-based targets by specified amounts. This includes identifying the makes and model types equipped with each technology, the compliance category those vehicles belong to, and the associated fuel economy improvement value for each technology.¹¹⁶⁶ In some cases, NHTSA may require manufacturers to provide supplementary information to justify or explain the benefits of these technologies and their impact on fuel consumption or to evaluate the safety implication of the technologies. These details are necessary to facilitate NHTSA's technical analyses and to ensure the agency can perform enforcement audits as appropriate.

NHTSA uses manufacturer submitted PMY, MMY, and supplementary reports to assist in auditing manufacturer compliance data and identifying potential compliance issues as early as possible. Additionally, as part of its footprint validation program, NHTSA conducts vehicle testing throughout the model year to confirm the accuracy of the track width and wheelbase measurements submitted in the reports.¹¹⁶⁷ These tests help the agency better understand how manufacturers may adjust vehicle characteristics to change a vehicle's footprint measurement, and ultimately its fuel economy target. NHTSA also includes a summary of manufacturers' PMY and MMY data in an annual fuel economy performance report made publicly available on its PIC.

As mentioned, NHTSA uses EPA-verified final-model year (FMY) data to evaluate manufacturers' compliance with CAFE program requirements and draw conclusions about the performance of the industry as well as to conduct verification testing and audits. After manufacturers submit their FMY data, EPA verifies the information,

accounting for NHTSA and EPA testing, and subsequently forwards the final verified data to NHTSA.

(b) New CAFE Reporting Templates

(1) CAFE Reporting Templates Adopted in 2020 Final Rule and Revised in the 2021 NPRM

NHTSA adopted changes to its CAFE reporting requirements in the 2020 final rule with the intent of streamlining data collection and reporting for manufacturers while helping the agency obtain the best available data to inform CAFE program decision-makers. We adopted two new standardized reporting templates for manufacturers. NHTSA's goal was to adopt standardized templates to assist manufacturers in providing the agency with all the necessary data to ensure they comply with CAFE regulations.

The first template was designed to simplify reporting CAFE credit transactions. The template's purpose was to reduce the burden on credit account holders, encourage compliance, and facilitate quicker NHTSA credit transaction approval. Before the template, manufacturers would inconsistently submit information required by 49 CFR 536.8, creating difficulties in processing credit transactions. Using the template simplifies CAFE compliance aspects of the credit trading process and helps to ensure that trading parties follow the requirements for a credit transaction in 49 CFR 536.8(a).¹¹⁶⁸

The second template was designed to standardize reporting for CAFE PMY and MMY information, as specified in 49 CFR 537.7(b) and (c), as well as supplementary information required by 49 CFR 537.8. The template organizes the required data in a manner consistent with NHTSA and EPA regulations and simplifies the reporting process by incorporating standardized responses consistent with those provided to EPA. The template collects the relevant data, calculates intermediate and final values in accordance with EPA and NHTSA methodologies, and aggregates all the final values required by NHTSA regulations in a single summary worksheet.

NHTSA believes that the projections reporting template benefits both the agency and manufacturers by helping to avoid reporting errors, such as data omissions and miscalculations, and will ultimately simplify and streamline reporting. The template also allows manufacturers to enter information to

generate the required confidential versions of CAFE reports specified in 49 CFR part 537 and to automatically produce the required non-confidential versions by clicking a button within the template. In the 2020 final rule, NHTSA established that manufacturers are required to use the projections template for all PMY, MMY, and supplementary CAFE reports starting in MY 2023. NHTSA made both the credit transactions and projections templates available for download through the NHTSA PIC website and DOT docket for interested parties to evaluate prior to their mandatory dates.

In the 2020 final rule, NHTSA also adopted provisions for manufacturers to report confidential information on the cost of credit trades and all the supporting trade documents. The agency established that manufacturers were to report this information starting January 1, 2021. NHTSA intended for the information to be used to establish the true cost of compliance for all manufacturers which will be used by agency decisions makers in developing new rulemakings. Additionally, as a long-term goal, NHTSA hoped to use the information as a part of new reports to be release to the public.

Since then, manufacturers have downloaded the templates and met with NHTSA to share recommendations for changes, such as allowing the PMY and MMY reporting templates to accommodate different types of alternative fueled vehicles and to clarify and correct the methods for calculating CAFE values. As a part of the 2021 NPRM,¹¹⁶⁹ NHTSA released several draft changes to the previous templates and added a new template for the monetary and non-monetary costs and terms associated with CAFE credit trades. The following sections will describe the comments received to the three templates and the final changes enacted by this final rule.

(2) Changes to the CAFE Projections Reporting Template

Along with the 2021 NPRM,¹¹⁷⁰ NHTSA released version 2.21 of the CAFE Projections Reporting Template. Version 2.21 included several general improvements made to simplify the use and the effectiveness for manufacturers. The changes included, but were not limited to; wording changes, corrections to calculations and codes, and auto-populating fields previously requiring manual entry. With this final rule we will be releasing version 2.25 of the CAFE Projections Reporting Template,

¹¹⁶⁶ NHTSA collects model type information based upon the EPA definition for "model type" in 40 CFR 600.002.

¹¹⁶⁷ U.S. Department of Transportation, NHTSA, Laboratory Test Procedure for 49 CFR part 537, Automobile Fuel Economy Attribute Measurements (Mar. 30, 2009), available at <http://www.nhtsa.gov/DOT/NHTSA/Vehicle%20Safety/Test%20Procedures/Associated%20Files/TP-537-01.pdf> (accessed: March 15, 2022).

¹¹⁶⁸ Submitting a properly completed template and accompanying transaction letter will satisfy the trading requirements in 49 CFR part 536.

¹¹⁶⁹ 86 FR 49602 (Sept. 3, 2021).

¹¹⁷⁰ 86 FR 49602 (Sept. 3, 2021).

which addresses and fixes many of the concerns raised in the comments, below.

More specifically, NHTSA modified the CAFE Reporting Template in the proposal by adding filters and sorting functions to help manufacturers connect the data definitions to the location of each of the required data fields in the template. Additional information from other parts of the CAFE Reporting Template would be pulled forward to display on the summary tab. For the information required pursuant to 49 CFR 537.7(b)(2), areas were also included for manufacturers to compare the values the template calculates to their own internally calculated CAFE values. Additionally, NHTSA expanded the CAFE Reporting Template to include more of the required information regarding vehicle classification, and eased manufacturers reporting burden by having them report only the data used for each vehicle's qualification pathway ignoring other possible light truck classification information.

NHTSA also combined the footprint attribute information and model type subconfiguration data. NHTSA uses this information to match test data directly to fuel economy footprint values for the purposes of modeling fuel economy standards. Features were also added to auto-populate redundant information from one worksheet to another. The data gathered and the formulas coded within the worksheets were also updated to correct fuel economy calculations based on 40 CFR 600.510–12. The changes allowed the data to more accurately represent the fuel economy of electric and other vehicles using alternative fuels. NHTSA considers this information critically important to forming a more complete picture of the performances of dual fuel and alternative fuel vehicles.

We also made several corrections so that manufacturers would submit CAFE data at each of the different levels they test and combine the stages of CO₂ and fuel economy test results. As mentioned, manufacturers test approximately 90-percent of their vehicles within each model type. Each subconfiguration variant within a model type may have a unique CO₂ and CAFE value. Manufacturers combine at the configuration, base level and then finally at the model type level for determining CAFE performance. NHTSA determined that this level of data was needed to verify manufacturers reported CAFE values.

Finally, NHTSA made corrections to the CAFE Reporting Template to better collect information on off-cycle

technologies. The changes aligned the format of the data with the EPA off-cycle database system. For example, manufacturers report to EPA high efficiency lighting as combination packages, so NHTSA changed the template to reflect the same level of information.

NHTSA will make version 2.25 of the template available on NHTSA's PIC site for download concurrent with the final rule being published.

In response to the 2021 NPRM,¹¹⁷¹ multiple manufacturers commented in support of the revised template. Mercedes Benz, Ford, Hyundai, Stellantis, and Lucid, support the use of a standardized template for CAFE reporting.¹¹⁷² Ford appreciates NHTSA is aligning with some of the existing EPA reporting data elements but believes that additional improvements can be made, particularly regarding the format of data collected. NHTSA will continue to work with EPA to determine areas where reporting can be further aligned for future rulemakings.

Nissan suggested streamlining the template by eliminating unnecessary details in the template.¹¹⁷³ They believe that the amount of detail requested in the CAFE Reporting Template is extensive and substantially increases the resources required in the data preparation process. Mercedes Benz shared a similar view and added that time periods for preparing PMY and MMY reports could be troublesome since some of the information requested is not yet available for submission, and can only be confirmed at the conclusion of the MY.¹¹⁷⁴ Ford recommends that less detailed data be required for the pre-model year reports compared to the mid-model year reports. It believes this is appropriate because higher level planning projections are used in the pre-model year reports, whereas substantial production data is normally used for the mid-model year report.¹¹⁷⁵ Auto Innovators requested that NHTSA align its data requirements more closely with the data that are available to manufacturers at the time pre- and mid-model year reports are prepared.¹¹⁷⁶ Auto Innovators stated that the pre-model year report is largely a projection

¹¹⁷¹ 86 FR 49602 (Sept. 3, 2021).

¹¹⁷² Mercedes-Benz, NHTSA–2021–0053–0952–A1, at p3; Ford, NHTSA–2021–0053–1545–A1, at p4; Hyundai, NHTSA–2021–0053–1512–A1, at page 8.; Stellantis, NHTSA–2021–0053–1527, at page 30; Lucid, NHTSA–2021–0053–1584, at 6.

¹¹⁷³ Nissan, NHTSA–2021–0053–0022, at 9.

¹¹⁷⁴ Mercedes-Benz, NHTSA–2021–0053–0952–A1 at p. 3.

¹¹⁷⁵ Ford, NHTSA–2021–0053–0952–A1, at p. 4.

¹¹⁷⁶ Auto Innovators, NHTSA–2021–0053–1492, at page 77.

due for each current model year during the month of December which makes it not valuable enough for modeling since attributes like paint colors or lighting packages, that are currently required information in the proposed reporting template (for off-cycle technologies) until after the end of the model year when manufacturers submit their final reports to the EPA.

NHTSA understands manufacturers concerns with the early production limitations for vehicles and technologies which can prevent manufacturers from having data available for the PMY and MMY template. Consequently, NHTSA is changing the requirements for the CAFE projections template for the final rule; manufacturers will only be required to provide actual information on vehicles and technologies in production at the time the PMY and MMY model year reports are required. Manufacturers should attempt not to omit data, which should only be the case for products pending production and with unknown information at the time CAFE reports are prepared.

Hyundai and Auto Innovators commented that they were concerned that the agency was going to publish confidential business data in its public forecast volume reports or to use the data in such a manner that could be reversed engineered.¹¹⁷⁷ NHTSA has further reduced this possibility by hiding the “total credits” columns in the public report to prevent any back calculation. The public report will be generated by pressing the ‘generate public report’ button on the general info tab and will no longer contain enough information for back calculations to occur. NHTSA will not publish any PMY/MMY data, or any data that can be reversed engineered to reveal confidential business information. Confidential business data will only be used by NHTSA for internal modeling and analysis.

Mercedes Benz requested that NHTSA eliminate MMY reports to relieve the burden on manufacturers.¹¹⁷⁸ However, NHTSA is unable to eliminate the MMY report because these reports are mandated by Congress in EPCA.¹¹⁷⁹ In addition, there is information contained in the PMY and MMY reports that is not in the EPA reports such as vehicle classification information that is critical to NHTSA's compliance program. The MMY reports also provide a near final estimate of all the values. Most

¹¹⁷⁷ Hyundai, NHTSA–2021–0053–1512–A1, page 8; Auto Innovators, NHTSA–2021–0053–1492, at page 77.

¹¹⁷⁸ Mercedes-Benz, NHTSA–2021–0053–0952–A1, at p. 3.

¹¹⁷⁹ 49 U.S.C. 32907(a)(2).

manufacturers are close to completing production for the model year when MMY reports are required.

Auto Innovators also requested several technical corrections to the reporting template to align with industry and EPA testing and data reporting uses. Summarized in the following paragraphs are those requests and NHTSA's responses and changes for the final rule.

- Clarification on which fields are mandatory and which are optional.¹¹⁸⁰ No changes were made to the template for the final rule in response to this request. Generally, the data fields colored in white are mandatory. Manufacturers should only consider a white data field optional if it does not produce vehicles requiring the information in that area. Manufacturers are responsible for determining if any vehicles in their fleet fit the requirements of the data field and must be reported. NHTSA will consider methods to further improve the template in future rulemakings if further guidance is needed.

- Asked NHTSA to further harmonize reporting requirements with EPA. For example, Auto Innovators stated that NHTSA has seven values for Fuel System and EPA has eleven. Similarly, NHTSA has three values for Drive System/Mode and EPA has five values. Auto Innovators recommended that NHTSA modify their template to use EPA values as input values and if NHTSA needs alternate values for their internal analysis, then the template could provide that translation. Auto Innovators request that EPA and NHTSA align their reporting values before manufacturers have to redesign their information technology systems to accommodate the new NHTSA template.¹¹⁸¹ NHTSA agrees with Auto Innovators' recommendations and has updated the drop-down menus in the template to reflect those provided by EPA for the final rule.

- Eliminate the reporting requirement for Basic Vehicle Frontal Area that has been replaced with GVWRs.¹¹⁸² The agency recognizes this legacy reporting field is no longer applicable to the current fuel economy calculations and thus agrees with Auto Innovators. For the final rule, NHTSA has removed the field for Basic Vehicle Frontal Area from the reporting template.

- Identified a problem on the summary tab with the rollup alternative

dual fuel equation.¹¹⁸³ For the final rule, NHTSA has fixed this error in the template. Alternative dual fuel will only be calculated on the summary tab if there is alternative dual fuel identified in the fleet.

- Identified an issue regarding Equivalent Test Weight. It stated that, in column "AY" and field "ETW," it appears as if test weight is calculated automatically from curb weight.¹¹⁸⁴ NHTSA sees how base level can cross two ranges for the ETW based upon historic regulations. For the final rule, NHTSA has developed a user manual for the template to give guidance on how to handle a situation where two ranges are covered as well as providing clarifications on other data uses in the template. As defined in the manual, manufacturers will have to create two base levels one for each range covered. NHTSA have conferred with EPA, and they have informed us that this is how they currently handle this issue with ETW ranges.

- Raised concerns about how data were collected at the subconfiguration level. Auto Innovators is concerned that these data are being collected on the subconfiguration level that is not aligned with the EPA definition. The carline class is unique for each model type and so collecting this data on a subconfiguration level is very repetitive and inefficient. Auto Innovators believes it would be more efficient for NHTSA to collect this and other data in a manner better aligned with the definitions. It recommend that NHTSA update its template to collect model type level data on the model type worksheets.¹¹⁸⁵ For the final rule, NHTSA has updated the reporting template to collect carline class information on the Model Type level instead of the subconfiguration level.

- Requested that NHTSA change the name of cell AM16 in the Footprint and Subconfig tab from "Auxiliary Emission Control Devices" (AECD) to "Emission Control Devices". NHTSA agrees that this is a more appropriate term for this column and has changed the name in the reporting template for the final rule.

- Commented the Footprint and SubConfig tab in columns "BU, BV, BW, BY, BZ, CA, CB, CE, CI" under the Base and Alternative Fuel field that when conventional gasoline is selected under base fuel in column BI and no alternative fuel input is done. It recommends that the columns should not display any MPGe values when "conventional gasoline" is selected.

This column is intended to calculate either the MPGe or MPG, depending on the input. For alternative fuel calculating the MPGe involves converting the fuel economy to MPGe, for conventional gasoline this simply involves multiplying the MPG by one to get MPGe. The MPGe is then used in calculating the combined fuel economy. NHTSA disagrees with Auto Innovators suggestions and for the final rule will keep this column as proposed since it accurately reflects the content of the data. NHTSA believes the current content of the data is appropriate and not complicated to understand its usage.

- Questioned why production volumes are user inputted, as opposed to automatically calculated for the Production Volume fields on the configuration, base level, and model type worksheet tabs. Explained that once production volume is entered for each carline on a subconfiguration level, the values should be carried over wherever carlines and their corresponding production volumes are present in each of the higher-level tabs such as configuration, base level, and model type. For the final rule, NHTSA will not make changes in response to this request. The spreadsheet is structured in such a way that automatic calculations would not be possible for these production volumes.

- Recommended that footprint data be required on the carline level, which is part of a model type definition, and aligned with the submission format required by EPA. It explained that the NHTSA template proposes to combine the footprint attribute information and model type subconfiguration data for the purposes of matching test data directly to fuel economy footprint values for modeling fuel economy standards. Auto Innovators believes that the subconfiguration and footprint data should not be combined. A subconfiguration can only have a single fuel economy value and yet may contain multiple footprints/wheelbases because subconfigurations are largely based on powertrain, weight, and road load attributes. In 49 CFR part 537, it requires footprint data for each unique model type and footprint combination and NHTSA has defined that the base (standard) tire is to be used for footprint data. However, footprint data on the template are required to be provided on a subconfiguration level. A manufacturer can have hundreds of subconfigurations in a single fleet. Auto Innovators contends it is not efficient nor beneficial to either keep repeating the same footprint data across a subconfiguration or to further subdivide a subconfiguration by the multiple

¹¹⁸⁰ Auto Innovators, NHTSA-2021-0053-1492, at pp. 77-81.

¹¹⁸¹ *Id.*

¹¹⁸² *Id.*

¹¹⁸³ *Id.*

¹¹⁸⁴ *Id.*

¹¹⁸⁵ *Id.*

wheelbases in them. It will not help NHTSA to find the applicable footprint record for a physical vehicle that's been obtained as part of the footprint validation program to have repeating values in the template. NHTSA has considered Auto Innovators' concerns and decided for the final rule not to make any changes to this data collection. The agency's need to support our data analysis and modeling compels retaining the format as proposed and repeated values will have no impact on compliance testing.

- Clarify that NHTSA states each subconfiguration variant within a model type has a unique CO₂ and CAFE value. Manufacturers combine other vehicles at the configuration, base level and then finally at the model type level for determining CAFE performance. Auto Innovators would like to clarify that each subconfiguration variant may or may not have a unique CO₂ and CAFE value as some subconfiguration variants are untested. NHTSA understands Auto Innovators' concerns and has added to the preamble text for the final rule that there may or may not be a unique CO₂ and CAFE value represented.

- Clarify what is meant by "other vehicles" from different nameplates may be combined at the subconfiguration, configuration, and base level because these are defined by attributes like powertrain, weight, and total road load horsepower but not at the model type level. A model type is defined by carline and so "other vehicles" wouldn't apply in this context. NHTSA agrees with Auto Innovators' concerns and for the final rule has removed 'model type' from the sentence in the preamble text.

- Auto Innovators requested several small changes to the language and rounding in the template. Under the "Data Definitions" tab, in row 66, it says, "Type of Overdrive/Torque converter", but in "Footprint & SubConfig" tab, it is asking for "Presence of over drive (Y/N). We respectfully request you change the data definition description from "Type" to "Presence" of Overdrive to match Col O in Footprint & Sub Conf tabs." Additionally, in the "Data Definitions" tab, cells F99, F100, F172, and F173, the total drive ratio min & max descriptions should have only 1 decimal place (##.#) to match input in Footprint and SubConfig tabs. NHTSA is adopting the changes requested by Auto Innovators for the final rule, but note that the information manufacturers will be required to submit will remain unchanged from the proposal. The changes requested by Auto Innovators

were a combination of style and clarifications to the template.

- Auto Innovators requested changes under the "Vehicle Classification" worksheet tab, under columns "AC" and "AD." Per 49 CFR 537.7(c)(4)(xvi)(B)(2), only cargo volume is required to be reported, thus cargo bed width and length is not required. Auto Innovators requested that NHTSA remove "Cargo bed width and length"—as cargo volume is already requested. Auto Innovators believes this is an unnecessary extra burden that could result in conflicting data. However, NHTSA disagrees with Auto Innovators and our regulations specifically require the length of cargo beds to be reported for vehicle classification and is also used for verifying full size pickup trucks for the incentive NHTSA uses in 40 CFR 86.1870–12. Therefore, NHTSA will not be removing this requirement.

- Auto Innovators contended that the Fuel Economy Base Level Tab—In column AI, under 40 CFR 600.208–12(a)(4) and (5), the Combined (CMB) formula is incorrect and suggested that NHTSA use a harmonic average for the CMB formula. The current 55:45 ratio is used only for vehicle configuration calculation. Additionally, it prefers a direct user input, rather than automatic calculation. Additionally, Auto Innovators believes that the automatic calculation is not necessary. It requests that "direct input" is used, rather than an automatic calculation for the CMB. Because 45/55 is only found in the calculation for configuration level, when calculating at the base level you need to roll up the configuration level calculation. For the final rule, NHTSA will retain the proposed CMB formulas. The method used in the template was confirmed with the approach used by EPA for determining CAFE values.

- Requested additional columns be added to the Air Conditioning Efficiency tab to allow for additional approved technologies. In the Air Conditioning Efficiency tab, under column AC for the Advanced Technology Compressor, it requests that NHTSA allow additional input columns for both existing and approved technologies. This is to ensure that future technologies are accounted for as they come to market and are applicable under the credit program. NHTSA understands that these additional columns may be needed in a future version when additional technologies are approved. Therefore, for the final rule, NHTSA has added several additional columns to the template and will continue to add additional columns as needed. This template will continue to undergo other changes as needed by

NHTSA and manufacturers, in the future, to accommodate, changes in technologies, vehicles and programmatic requirements.

Finally, Ford and Auto Innovators requested that NHTSA update part 537 to allow submission of confidential reporting of the template by email rather than requiring submissions on CD-ROM.¹¹⁸⁶ NHTSA agrees that submission sent by email are effective and resolves problems with delayed or lost CAFE reports. Therefore, for the final rule, NHTSA has updated its provisions in part 537 to accommodate electronic reporting.

(3) Credit Transactions Reporting Template

NHTSA released a new version of its CAFE credit transactions template, fixing several calculation errors as a part of the 2021 NPRM,¹¹⁸⁷ and released the template for download on the NHTSA PIC. In the previous 2020 final rule, NHTSA had established using the credit template as the sole source for executing CAFE credit transactions starting January 1, 2022. However, as a result of these errors the effective date for the Credit Transaction Reporting Template will now be September 1, 2022.

In response to the NPRM, Stellantis commented that it supports the proposed transaction template and finds the joint trade instruction document it generates helpful.¹¹⁸⁸ Although in its views, Stellantis believes the current template is unworkable because it requires a manufacturer to share the planned use of credits which may not be known with precision. Stellantis stated that the transaction types are not defined in the data definitions, nor in 49 CFR 536.8 as referenced. NHTSA has updated the user guide with the data definitions for the final rule.

A comment received from Auto Innovators also identified an error message that ASTM Rounding Module is not supported in older versions of Excel.¹¹⁸⁹ Due to the functions of VBA coding used in the templates, NHTSA cannot create a template that works with all older versions of Excel. As for those manufacturers who experienced an ASTM Rounding Module error, NHTSA recommends these manufacturers should update to a newer version of Microsoft Excel that will work with VBA coding. NHTSA notes that this should not impose any additional cost or burden on manufacturers because

¹¹⁸⁶ Ford, NHTSA–2021–0053–0952–A1, at p. 4; Auto Innovators, pp. 77–81.

¹¹⁸⁷ 86 FR 49602 (Sept. 3, 2021).

¹¹⁸⁸ Stellantis, NHTSA–2021–0053–1527, at p. 30.

¹¹⁸⁹ Auto Innovators, NHTSA–2021–0053–1492, at p. 82.

those with access to Microsoft Excel are offered upgrades to versions with VBA at no additional cost.¹¹⁹⁰

In addition, NHTSA is changing in this final rule the effective date for its credit transactions template from January 1, 2022, to September 1, 2022. This date provides manufacturers additional implementation time and coordinates the implementation start date of the credit template.

(4) Monetary and Non-Monetary Credit Trade Information

Credit trading became permissible starting with MY 2011.¹¹⁹¹ As discussed earlier, NHTSA maintains an online CAFE database with manufacturer and fleetwide compliance information that includes year-by-year accounting of credit balances for each credit holder. While NHTSA maintains this database, the agency's regulations currently state that it will not publish information on individual transactions, and NHTSA has not previously required trading entities to submit information regarding the compensation (whether financial, or other terms of value) exchanged for credits.^{1192 1193}

In 2020 final rulemaking, NHTSA adopted requirements in 49 CFR 536.5(c)(5) to submit all credit trade contracts, including cost and transactional information, to the agency starting January 2021. NHTSA also adopted requirements allowing manufacturers to submit the information confidentially, in accordance with 49 CFR part 512.¹¹⁹⁴ In the NPRM, we proposed adding a credit reporting template for monetary and non-monetary credit terms.

Manufacturers continued to argue that disclosing trading terms may not be as simple as a spot purchase at a given price. As stated in the 2020 final rule, manufacturers contended a number of transactions for both CAFE and CO₂ credits involve a range of complexities due to numerous factors that are reflective of the marketplace, such as the volume of credits, compliance category, credit expiration date, a seller's compliance strategy, and even the CAFE penalty rate in effect at that time. In addition, automakers have a range of partnerships and cooperative

agreements with their own competitors. Credit transactions can be an offshoot of these broader relationships, and difficult to price separately and independently.

In an effort to assist manufacturers with understanding and complying with the requirements promulgated in the 2020 final rule, NHTSA identified a series of non-monetary factors that it believed to be important to the costs associated with credit trading in the CAFE program that manufacturers should be reporting.¹¹⁹⁵ NHTSA developed and proposed a new CAFE Credit Value Reporting Template (Form 1621) for capturing the monetary and non-monetary terms of credit trading contracts. NHTSA proposed that manufacturers start using the new template starting September 1, 2022. The draft template was made available for download from the NHTSA PIC site.

Mercedes Benz, Stellantis, and Auto Innovators opposed reporting monetary and non-monetary terms associated with credit trades for various reason.¹¹⁹⁶ Volvo strongly supported more transparency so that buyers and sellers can achieve fair and reasonable deals.¹¹⁹⁷ Mercedes,¹¹⁹⁸ requested that NHTSA refrain from making its value template mandatory for submitting credit transactions. Mercedes commented that in the event such information is ever released to the public, it would have a deleterious effect upon OEMs. It stated that credit transactions arise from compliance strategies for manufacturers, which typically occur over multi-MY time frames. In the event such information was ever released to the public, Mercedes argued it would have a harmful effect on those OEMs whose strategy is released, in particular those OEMs who are dependent on credits in order to achieve compliance. Additionally, Mercedes believes releasing this information to the public may have an unintended, detrimental consequence to the future credit market, putting OEMs who use credits as part of their compliance strategy at a competitive disadvantage. Other opposing views from manufacturers also centered around the unintended consequences that might occur if confidential credit information were to

be publicly shared. Both Stellantis¹¹⁹⁹ and Auto Innovators¹²⁰⁰ opposed greater public transparency for these reasons. Stellantis stated that the release of public information would likely require manufacturers to disclose details from confidential negotiations and agreements, likely covered by non-disclosure agreements (NDAs). Auto Innovators raised similar concerns contending that confidentiality concerns exists whether NHTSA intends to disclose the data to the public. It stated that requiring highly sensitive confidential information is simply not necessary, and the risks of a breach in confidentiality outweighs what little value NHTSA may derive from such data. Stellantis offered a counterproposal for NHTSA to provide additional public credit trading information aligned with the EPA GHG program (*i.e.*, credit vintage, credit amounts transferred, and fleet category).

Other comments offered by Stellantis and Auto Innovators focused on the lack of necessity or relevance for the information required by the credit value template.¹²⁰¹ Stellantis commented that providing the true value of a credit trade is unknown when credits are banked because the adjustment factor for preserving "equivalent gallons" is applied only at the time a credit is used to resolve a future shortfall.¹²⁰² They argued that only the cost per credit from the credit user's perspective would help NHTSA understand how market pricing compares to the civil penalty price ceiling. They argued that the delayed understanding of value, coupled with the additional reporting burden has questionable public benefit, and could violate the terms of NDAs. Auto Innovators stated that the credit value template fails to achieve its intended objectives, is unnecessary to the administration of the CAFE program, and is overly burdensome to manufacturers.¹²⁰³ Auto Innovators argued that non-monetary considerations are likely not straightforward or clear, requiring significant research and numerous meetings with coworkers to derive an equivalent monetary value. Further, it believes the requirements exceed NHTSA's statutory authority. Auto Innovators contended that NHTSA has authority to require reports necessary

¹¹⁹⁰ For assistance with updating Excel, please reach out to Microsoft support.

¹¹⁹¹ 49 CFR 536.6(c).

¹¹⁹² 49 CFR 536.5(e)(1).

¹¹⁹³ NHTSA understands that not all credits are exchanged for monetary compensation. The proposal that NHTSA is adopting in this final rule requires entities to report compensation exchanged for credits and is not limited to reporting monetary compensation.

¹¹⁹⁴ See also 49 U.S.C. 32910(c).

¹¹⁹⁵ UCS, Detailed Comments, NHTSA-2018-0067-12039; Jason Schwartz, Detailed Comments, NHTSA-2018-0067-12162.

¹¹⁹⁶ Mercedes-Benz, NHTSA-2021-0053-0952-A1, at p. 4; Stellantis, NHTSA-2021-0053-1527, at p. 29; Auto Innovators, NHTSA-2021-0053-1492, at pp. 72-77.

¹¹⁹⁷ Volvo, NHTSA-2021-0053-1565, at p. 4.

¹¹⁹⁸ Mercedes-Benz, at p. 4.

¹¹⁹⁹ Stellantis, NHTSA-2021-0053-1527, at p. 29; Auto Innovators, NHTSA-2021-0053-1492, at pp. 72-77.

¹²⁰⁰ Mercedes Benz, at p. 4.

¹²⁰¹ Stellantis, NHTSA-2021-0053-1527, at p. 29.

¹²⁰² The adjustment factor is defined in 49 CFR 536.4(c).

¹²⁰³ Auto Innovators, NHTSA-2021-0053-1492, at pp. 72-77.

for it to carry out the CAFE, but the required template exceeds what is necessary to carry out the CAFE program. Auto Innovators also contended that for the purposes of future rulemaking, in determining maximum feasible standards, NHTSA is prohibited from considering the trading, transferring, or availability of credits.¹²⁰⁴ Therefore, data in the Credit Value Reporting Template is not informative to the standard-setting process. It further explained that requiring non-standardized data and unquantifiable contractual terms is clearly unnecessary for the determination of manufacturer compliance with the CAFE program, and their use in rulemaking is limited at best with other, better options, such as estimates, sensitivity analyses based on the CAFE civil penalty rate, or comparisons of model runs with manufacturers separated and aggregated, available.

Auto Innovators stated that despite NHTSA's views, manufacturers have no need to make the cost of credit trade information publicly available to facilitate credit trading.¹²⁰⁵ Automobile manufacturers wishing to engage in credit trading generally negotiate terms through direct contact. Auto Innovators stated that there is no mystery or confusion to be resolved through government intervention. Stellantis supports Auto Innovators' position and reiterated that NHTSA already knows the price ceiling is the CAFE civil penalties logically as no manufacturer would pay more for credits.

Additional comments from Auto Innovators were also received on the adequacy of the credit value template for the public and for NHTSA and on its burden to manufacturers.¹²⁰⁶ First, Auto Innovators believes the template would have little practical (or even academic) value to the public given that credit transactions likely have a wide range of values depending on market forces (relative supply and demand) at the time a trade is made and regulatory compliance considerations applicable to the specific traded credits, which can vary based on credit vintage, source, and anticipated future use of the credit for the purchasing party. Second, it believes that the template would not be helpful to NHTSA because non-monetary valuations are nearly impossible to quantify and use as a meaningful point of comparison underestimates the complicated commercial and manufacturing

relationships manufacturers may have with other companies. There is no possible "template" that can adequately cover the entire range of possible monetary and non-monetary exchanges between manufacturers. Trying to categorize complex contracts, business relationships, production arrangements, and exchanges of technology into simple topics such as "chassis technology" or "off-cycle technology" is simply not possible and provides virtually no value to the administration of the CAFE program. This is especially true when credits may be generated by new market entrants, and value may be in the form of options, equity interest, royalties, real estate, or other assets.

Auto Innovators closed its arguments stating that NHTSA's concerns for greater oversight are not served by the data requirements of the Credit Value Reporting Template.¹²⁰⁷ NHTSA cited protection against fraud, manipulation, market power, and abuse. Auto Innovators believes NHTSA's views seem to be more hypothetical than real, and more importantly, that NHTSA fails to describe how the desired information will aid in preventing or addressing its intended goals.

Volvo stated the credit value template provides more transparency so that buyers and sellers can achieve fair and reasonable deals especially considering the changing landscape of future regulations leading to greater electrification in the market.¹²⁰⁸ Volvo believes adopting electrification in the vehicle fleet will impact the current trading market where technology exchange as part of a trade will be less likely to occur and therefore, the price of a credit in a trade will be more accurately reflected. Volvo also commented that one reason why some automobile manufacturers suggest that the proposed reporting associated with the credit value template under the NPRM is unnecessary is that the current trading market has been "functioning properly" but also in a now dated marketplace consisting primarily of traditional internal combustion engine regulations. Once the regulations are modified for electric vehicles the balance between monetary and non-monetary trades may change. Therefore, Volvo Cars supports NHTSA's proposal to require use of the NHTSA "Credit Value Reporting Template" (Form 1621) when a credit trade is executed is to help ensure that the future electrified trading market also functions properly.

NHTSA has reviewed the comments received and offers several clarifications

and responses. In regard to concerns about non-disclosure agreements (NDAs), NDAs are not intended to be legal mechanisms to circumvent duly promulgated laws and regulations. NHTSA notes that many NDAs contain language exempting disclosures required by law to avoid creating an unenforceable promise. NHTSA has faith that manufacturers will be able to draft NDAs in a manner consistent with our regulations. We also note that existing NDAs should not be impacted by this change; 49 CFR 536.8(d) precludes manufacturers from entering into agreements for credits not currently possessed—we call this a restriction on forward sales—hence manufacturers cannot have already entered into long-term sales and NDA agreements for future credits.

Manufacturers are also concerned the information in the templates, if released to the public or other manufacturers, could cause potential harm to multi-year compliance strategies by adversely placing certain companies at a competitive disadvantage. As stated in the 2020 final rule, NHTSA will attempt to limit the disclosure of confidential information—including aggregating data wherever possible—which manufacturers identified as harmful in their comments, and will attempt to work with manufacturers before publishing potentially sensitive information. The agency also notes that much of the data necessary to discern which manufacturers are buying and selling credits is already public domain, as credit balances and fuel economy data can be used to reverse engineer manufacturers credit transactions. However, NHTSA remains sensitive to manufacturers confidentiality concerns. In fact, 49 CFR 536.5(e)(1) already includes requirements which precludes NHTSA from publicly disclosing individual transactions and responding to individual requests for updated balances from any party other than the account holder. Consequently, NHTSA would likely find no reason to disclose the costing information involved in a manufacturer's individual credit transaction.

As for manufacturers' contentions questioning the relevance or necessity for NHTSA receiving information on the value of credit trades, there is a fundamental misunderstanding of what the agency was proposing in this rulemaking. We were not proposing that manufacturers submit additional information. The templates were intended to clarify and streamline the information that manufacturers are already required to submit pursuant to 49 CFR 536.5. We believe that

¹²⁰⁴ *Id.*

¹²⁰⁵ *Id.*

¹²⁰⁶ *Id.*

¹²⁰⁷ *Id.*

¹²⁰⁸ Volvo, NHTSA-2021-0053-1565, at p. 4.

templates—like the draft templates—can assist both manufacturers and the agency with identifying the key that need to be reported. Some manufacturers seemed to be under the impression that the templates would require credit trade disclosures and raised their concern that NHTSA might misuse the information from its Credit Value template for the purposes of influencing the maximum feasible standards for future CAFE rulemaking. We note that these comments were outside the scope of the rulemaking as manufacturers are already required to provide that information. Furthermore, collecting these data from manufacturers does not cause a material harm to manufacturers as the data do not impose stricter fuel economy standards. If commenters feel that we have used the data inappropriately in future rulemakings, they should comment to that effect.

As mentioned previously, it is NHTSA mission to oversee the CAFE program and understand all the aspects involving how manufacturers comply. We view this as including the true value of banked credits applied to future credit shortfalls and the non-monetary terms associated with credit trades. Manufacturers labeled this information as burdensome and unnecessary to administer the CAFE program. NHTSA disagrees and it is for these types of unknown factors NHTSA now seeks to acquire the information in its new template. As NHTSA stated, these factors must be known to fully understand the true cost of compliance. Furthermore, NHTSA plans to release additional templates in the future to collect supplemental costing information on technologies used for complying with its off-cycle program to improve its derived costs for generating earned credits. NHTSA will attempt to discuss these plans with manufacturers prior to the next CAFE rulemaking.

NHTSA agrees with manufacturers that non-monetary valuations will be difficult to quantify and that future changes may be needed to refine the template. For these reasons, NHTSA will delay requiring the new templates until a later date. However, we strongly encourage manufacturers to use the new revised draft templates. If the agency finds the new templates as satisfactory, we may be able to more narrowly tailor the reporting requirements of 49 CFR 536.5 to include only the information requested in the template.

3. What compliance flexibilities and incentives are currently available under the CAFE program and how do manufacturers use them?

Generating, trading, transferring, and applying CAFE credits is governed by statute.¹²⁰⁹ Program credits are generated when a vehicle manufacturer's fleet over-complies with its standard for a given model year, meaning its vehicle fleet achieved a higher corporate average fuel economy value than the amount required by the CAFE program for that fleet in that model year. Conversely, if the fleet average CAFE level does not meet the standard, the fleet incurs debits (also referred to as a shortfall or deficit). A manufacturer whose fleet generates a credit shortfall in a given model year can resolve its shortfall using any one or combination of several credit flexibilities, including credit carryback, credit carry-forward, credit transfers, and credit trades, and if all credit flexibilities have been exhausted, then the manufacturer must resolve its shortfall by making civil penalty payments.¹²¹⁰

NHTSA has also promulgated compliance flexibilities and incentives consistent with EPCA's provisions regarding calculation of fuel economy levels for individual vehicles and for fleets.¹²¹¹ These compliance flexibilities and incentives, which were first adopted in the 2012 rule for MYs 2017 and later, include AC efficiency improvement and off-cycle adjustments, and adjustments for advanced technologies in full-size pickup trucks, including adjustments for mild and strong hybrid electric full-size pickup trucks and performance-based incentives in full-size pickup trucks. The fuel consumption improvement benefits of these technologies measured by various testing methods can be used by manufacturers to increase the CAFE performance of their fleets.

(a) Available Credit Flexibilities

Under NHTSA regulations, credit holders (including, but not limited to manufacturers) have credit accounts with NHTSA where they can, hold credits, and use them to achieve compliance with CAFE standards, by carrying forward, carrying back, or transferring credits across compliance categories, subject to several

restrictions. Manufacturers with excess credits in their accounts can also trade credits to other manufacturers, who may use those credits to resolve a shortfall currently or in a future model year. A credit may also be cancelled before its expiration date if the credit holder so chooses. Traded and transferred credits are subject to an "adjustment factor" to ensure total oil savings are preserved.¹²¹²

Credit "carryback" means that manufacturers are able to use recently earned credits to offset a deficit that had accrued in a prior model year, while credit "carry-forward" means that manufacturers can bank credits and use them towards compliance in future model years. EPCA, as amended by EISA, allows manufacturers to carryback credits for up to three model years, and to carry-forward credits for up to five model years.¹²¹³ Credits expire the model year after which the credits may no longer be used to achieve compliance with fuel economy regulations.¹²¹⁴ Manufacturers seeking to use carryback credits must submit a carryback plan to NHTSA, for NHTSA's review and approval, demonstrating their ability to earn sufficient credits in future MYs that can be carried back to resolve the current MY's credit shortfall.

Credit "trading" refers to the ability of manufacturers or persons to sell credits to, or purchase credits from, one another while credit "transfer" means the ability to transfer credit between a manufacturer's compliance fleets to resolve a credit shortfall. EISA gave NHTSA discretion to establish by regulation a CAFE credit trading program, to allow credits to be traded between vehicle manufacturers, now codified at 49 CFR part 536.¹²¹⁵ EISA prohibits manufacturers from using traded credits to meet the minimum domestic passenger car CAFE standard.¹²¹⁶

(b) Fuel Savings Adjustment Factor

Under NHTSA's credit trading regulations, a fuel savings adjustment factor is applied when trading occurs between manufacturers and those credits are used, or when a manufacturer transfers credits between its compliance fleets and those credits are used, but not when a manufacturer carries credits forward or backwards within the same fleet.¹²¹⁷

¹²⁰⁹ 49 U.S.C. 32903.

¹²¹⁰ Manufacturers may elect to pay civil penalties rather than utilizing credit flexibilities at their discretion. For purposes of the analysis, we assume that manufacturers will only pay penalties when all flexibilities have been exhausted.

¹²¹¹ 49 U.S.C. 32904.

¹²¹² See Section VII.B.3.(b) for details.

¹²¹³ 49 U.S.C. 32903(a).

¹²¹⁴ 49 CFR 536.3(b).

¹²¹⁵ 49 U.S.C. 32903(f).

¹²¹⁶ 49 U.S.C. 32903(f)(2).

¹²¹⁷ See Section VII.A.3.(a) for details about carry forward and back credits.

NHTSA proposed in the 2021 NPRM to restore certain definitions that were a part of the adjustment factor equation that had been inadvertently deleted in the 2020 final rule. The 2020 final rule had intended to add a sentence to the adjustment factor term in 49 CFR 536.4(c), simply to make clear that the figure should be rounded to four decimal places. While the 2020 final rule implemented this change, the amendatory instruction for doing so unintentionally deleted several other definitions from that paragraph. NHTSA had not intended to modify or delete those definitions, so NHTSA is now simply adding the language back into the paragraph for this final rule.

(c) VMT Estimates for Fuel Savings Adjustment Factor

NHTSA uses VMT estimates as part of its fuel savings adjustment equation. Including VMT is important, as fuel consumption is directly related to vehicle use and, in order to ensure trading credits between fleets preserves oil savings, VMT must be considered.¹²¹⁸ For MYs 2017 and later, NHTSA finalized VMT values of 195,264 miles for passenger car credits, and 225,865 miles for light truck credits.¹²¹⁹

(d) Fuel Economy Calculations for Dual and Alternative Fueled Vehicles

As discussed at length in prior rulemakings, EPCA, as amended by EISA, encouraged manufacturers to build alternative-fueled and dual- (or flexible-) fueled vehicles by providing special fuel economy calculations for “dedicated” (that is, 100 percent) alternative fueled vehicles and “dual-fueled” (that is, capable of running on either the alternative fuel or gasoline/diesel) vehicles.

Dedicated alternative-fuel automobiles include electric, fuel cell, and compressed natural gas vehicles, among others. The statutory provisions for dedicated alternative fuel vehicles in 49 U.S.C. 32905(a) state that the fuel economy of any dedicated automobile manufactured after MY 1992 shall be measured “based on the fuel content of the alternative fuel used to operate the automobile. A gallon of liquid alternative fuel used to operate a dedicated automobile is deemed to contain 0.15 gallon of fuel.” There are no limits or phase-out for this special fuel economy calculation within the statute.

EPCA’s statutory incentive for dual-fueled vehicles at 49 U.S.C. 32906 and

the measurement methodology for dual-fueled vehicles at 49 U.S.C. 32905(b) and (d) expired after MY 2019. In the 2012 final rule, NHTSA and EPA concluded that it would be inappropriate and contrary to the intent of EPCA/EISA to measure dual-fueled vehicles’ fuel economy like that of conventional gasoline vehicles with no recognition of their alternative fuel capability. The agencies determined that for MY 2020 and later vehicles, the general statutory provisions authorizing EPA to establish testing and calculation procedures provide discretion to set the CAFE calculation procedures for those vehicles. The methodology for EPA’s approach is outlined in the 2012 final rule for MYs 2017 and later at 77 FR 63128 (Oct. 15, 2012).

(e) Flexibilities for Air-Conditioning Efficiency, Off-Cycle Technologies, and Full-Size Pickup Trucks

(1) Incentives for Advanced Technologies in Full-Size Pickup Trucks

Under its EPCA authority for CAFE and under its CAA authority for GHGs, in the 2021 Final Rule EPA and NHTSA established FCIVs for manufacturers that hybridize a significant quantity of their full-size pickup trucks, or that use other technologies that significantly reduce fuel consumption by these full-sized pickup trucks. More specifically, CAFE FCIVs were made available to manufacturers that produce full-size pickup trucks with Mild HEV or Strong HEV technology, provided the percentage of production with the technology is greater than specified percentages.¹²²⁰ In addition, CAFE FCIVs were made available for manufacturers that produce full-size pickups with other technologies that enable full-size pickup trucks to exceed their CAFE targets based on footprints by specified amounts (*i.e.*, electric vehicles and other electric components).¹²²¹ These performance-based incentives create a technology-neutral path (as opposed to the other technology-encouraging path) to achieve the CAFE FCIVs, which would encourage the development and application of new technological approaches.

Large pickup trucks represent a significant portion of the overall light duty vehicle fleet and generally have higher levels of fuel consumption and GHG emissions than most other light duty vehicles. Improvements in the fuel economy and GHG emissions of these

vehicles can have significant impact on the overall light-duty fleet fuel use and GHG emissions. NHTSA believes that offering incentives could encourage the deployment of technologies that can significantly improve the efficiency of these vehicles and that also will foster production of those technologies at levels that will help achieve economies of scale, would promote greater fuel savings overall and make these technologies more cost effective and available in the future model years to assist in compliance with CAFE standards.

EPA and NHTSA also established limits on the eligibility for these pickup trucks to qualify for incentives. According to the 2012 final rule a truck was required to meet minimum criteria for bed size and towing or payload capacities and meet minimum production thresholds (in terms of a percentage of a manufacturer’s full-size pickup truck fleet) in order to qualify for these incentives. Under the provisions, Mild HEVs are eligible for a per-vehicle CO₂ credit of 10 g/mi (equivalent to 0.0011 gallon/mile for a gasoline-fueled truck) during MYs 2017–2021. To be eligible a manufacturer would have to show that the Mild HEV technology is utilized in a specified portion of its truck fleet beginning with at least 20 percent of a company’s full-size pickup production in MY 2017 and ramping up to at least 80 percent in MY 2021. Strong HEV pickup trucks are eligible for a 20 g/mi credit (0.0023 gallon/mile) during MYs 2017–2021, if the technology is used on at least 10 percent of a company’s full-size pickups in that model year. EPA and NHTSA also adopted specific definitions for Mild and Strong HEV pickup trucks, based on energy flow to the high-voltage battery during testing. In the NPRM, NHTSA proposed extending these incentives to 2026.

Furthermore, to incentivize other technologies that can provide significant reductions in GHG emissions and fuel consumption for full-size pickup trucks, EPA also adopted a performance-based FCIV for full-size pickup trucks. Eligible pickup trucks certified as performing 15 percent better than their applicable CO₂ target receive a 10 g/mi credit (0.0011 gallon/mile), and those certified as performing 20 percent better than their target receive a 20 g/mi credit (0.0023 gallon/mile). The 10 g/mi performance-based credit was available for MYs 2017 to 2021 and, once qualifying; a vehicle model would continue to receive the credit through MY 2021, provided its CO₂ emissions level does not increase. To be eligible a manufacturer would have to show that the technology is

¹²¹⁸ See 49 CFR 536.4(c).

¹²¹⁹ 77 FR 63130 (Oct. 15, 2012).

¹²²⁰ 77 FR 62624, 62651 (Oct. 15, 2012).

¹²²¹ *Id.*

utilized in a specified portion of its truck fleet beginning with at least 20 percent of a company's full-size pickup production in MY 2017 and ramping up to at least 80 percent in MY 2021. The 20 g/mi performance-based credit was available for a vehicle model for a maximum of 5 years within the 2017 to 2021 model year period. In the 2021 NPRM NHTSA proposed extending these incentives through MY 2026, provided its CO₂ emissions level does not increase. To be eligible, the technology must be applied to at least 10 percent of a company's full-size pickups in for the model year.

The agencies designed a definition for full-size pickup truck based on minimum bed size and hauling capability, as detailed in 40 CFR 86.1866–12(e). This definition ensured that the larger pickup trucks, which provide significant utility with respect to bed access and payload and towing capacities, are captured by the definition, while smaller pickup trucks with more limited capacities are not covered. A full-size pickup truck is defined as meeting requirements (1) and (2) below, as well as either requirement (3) or (4) below.

(1) **Bed Width**—The vehicle must have an open cargo box with a minimum width between the wheelhouses of 48 inches. And—

(2) **Bed Length**—The length of the open cargo box must be at least 60 inches. And—

(3) **Towing Capability**—the gross combined weight rating (GCWR) minus the gross vehicle weight rating (GVWR) must be at least 5,000 pounds. Or—

(4) **Payload Capability**—the GVWR minus the curb weight (as defined in 40 CFR 86.1803) must be at least 1,700 pounds.

Both agencies ended the incentives for full-size pickup trucks after the end of model year 2021 believing expanded incentives would likely not result in any further emissions benefits or fuel economy improvements since an increase in sales volume was not anticipated. At the time, no manufacturer had qualified to use the full-size pickup truck incentives since they went into effect in MY 2017. One vehicle manufacturer introduced a mild hybrid pickup truck in MY 2019 but was ineligible for the FCIV because it did not meet the minimum production threshold. Other manufacturers had announced potential collaborations or started designing future hybrid or electric models, but none were expected to meet production requirements within the time period of eligibility for these incentives.

Since the 2020 final rule, many manufacturers have publicly announced several new model types of full-size electric pickup trucks starting in MY 2022. NHTSA notes that historically it has always encouraged manufacturers to equip emerging technologies that could lead to significant increases in the fleet's fuel efficiency. For this reason, even given the discontinuation in MY 2019 of AMFA incentives for dual fueled vehicles, NHTSA retained its benefits for alternative dedicated fueled vehicles given the growth of electric vehicles in the market. Therefore, after the careful consideration of this new information and the potential role incentives could play in increasing the production of these technologies, and the associated beneficial impacts on fuel consumption, the agency proposed in the 2021 NPRM to extend the full-size pickup truck incentive through MY 2026 for strong hybrids and for full-size pickup trucks performing 20-percent better than their target.¹²²² Also, understanding the importance of electric vehicles in the market, NHTSA proposed to allow manufacturers to combine both the incentives for alternative fueled vehicles and full-size pickup trucks FCIVs when complying with the CAFE program.

NHTSA received various comments concerning its proposed changes to the full-sized pickup truck incentive. Many of the same commenters also submitted responses to EPA for consideration in its GHG final rule.¹²²³ The ITB Group, Ltd. (ITB Group) submitted comments supporting reinstatement of the incentives for full-sized pickup strong hybrids with a 20 percent improvement in performance.¹²²⁴ The ITB Group agrees with the justification for reinstating the full-size pickup truck credits since full-size pick-up truck technologies are “particularly challenging due to the need to preserve the towing and hauling capabilities of the vehicles.” It commented that one improvement in the rule would be to provide a combined penetration requirement rather than an independent 10 percent requirements for multiple types of technologies. This would mean that any combination of strong hybrid and other 20 percent better performance technologies would fall under one cap. They suggest that this is an important technology-agnostic requirement, since it is not clear that the market will be receptive to a specific technology. As far as possible, the standards should be flexible and technology-agnostic to

incentivize fuel consumption and CO₂ emissions reductions.

The American Council for an Energy Efficient Economy (ACEEE) commented that it does not support the full-size pickup truck incentive.¹²²⁵ ACEEE stated that this incentive is another example of awarding credit in excess of actual emission reductions, which reduces the stringency of the standards. It believes this specific incentive is also problematic because the incentive could encourage the production of full-sized pickup trucks at the expense of smaller vehicles. ACEEE estimates that this provision alone could reduce fuel savings by up to 2 percent for the entire period of the rule, if all full-sized pickup trucks qualify for the credit by MY 2026.

MECA supported NHTSA's proposal to reinstate the original 2012 rule's full-size pick-up truck incentives for strong (full) hybrids or similar over performing technologies.¹²²⁶ Pick-up trucks, which are the second most popular light-duty vehicle segment in the North American market, are often identified as a greater technical and consumer acceptance challenge to higher efficiency standards. The presence of electric, full hybrid and other advanced technology vehicle options in this segment is clearly beneficial to consumers, the environment and energy conservation goals.

MECA further stated that the FCIVs for full-size pickups with HEV or other over performing technologies should require the use of additional advanced technologies that over perform targets by 20 percent. MECA feels the incentives are reasonable given that on average, pick-up trucks consume far greater amounts of fuel per year and are almost twice as likely to reach 200,000 miles compared to vehicles in other LDV segments. MECA further stated that given that large SUVs also commonly utilize the same chassis and powertrains as pick-up trucks, it believes that NHTSA should consider extending these advanced technology pick-up truck credits to similar large SUVs as well.

BorgWarner commented that it “supports NHTSA's [FCIVs] for full-size pick-up strong hybrids or similar overperforming technologies and gave recognition to EPA's flexibilities. NHTSA's proposal is ambitious and will require flexibilities to encourage technology development and adoption.”¹²²⁷ BorgWarner suggested

¹²²² 86 FR 49602 (Sept. 3, 2021).

¹²²³ See 86 FR 74434 (Dec. 30, 2021).

¹²²⁴ ITB Group, NHTSA–2021–0053–0019–A1, at page 6.

¹²²⁵ ACEEE, NHTSA–2021–0053–0074, at page 4.

¹²²⁶ MECA, NHTSA–2021–0053–1113, at page 3.

¹²²⁷ BorgWarner, NHTSA–2021–0053–1473, at page 2.

that NHTSA should consider extending the advanced technology pick-up truck credits to similar large SUVs since large SUVs utilize the same chassis and propulsion systems as pick-up trucks. Hybrid trucks offer a significant opportunity for fuel consumption improvements due to their high sales volume and relative fuel consumption. The existing credits have not achieved their goal of significantly increasing hybridization of trucks. The conditions necessary to earn these credits are stringent. Eliminating the volume requirement and awarding credits based on a sliding scale that relates the fuel economy of a hybrid vehicle to the same non-hybrid vehicle would provide a better incentive for hybridization in proportion to the value of the technology.

Tesla stated that, like EPA, NHTSA proposes to re-establish an additional credit incentive for full size pickups and underestimates the potential use of the credit.¹²²⁸ Tesla explained that electrification technology has become widely available and represents the best-in-class efficiency and emission reduction technology. Just as NHTSA acknowledges recent manufacturer announcements on electrification in its proposal, the agency should recognize the increasing announcements around full electric pick-up trucks. While the original rationale for credits was to incentivize technology development for this class of vehicles, that has now been accomplished and that rationale no longer exists. In short, Tesla believes the technology is available to be deployed for MY 2024–2026 vehicles, including pickups—and simply does not justify diluting the proposed standards' compliance stringency. Continuing multiplier incentive is unnecessary and after a decade of being an element in standards proposals now threatens to further institutionalize a compliance crutch for manufacturers to deliver a limited number of compliance vehicles to maximize credit accumulation with no incentive to deliver more wide-spread innovation and actual deployment and the accompanying emission benefits.

Volkswagen requested that NHTSA consider extending the applicability of high efficient vehicle FCIV factors to vehicles other than just full-size pick-up trucks.¹²²⁹ Volkswagen recognizes that such an extension would require modification by EPA to part 600 regulations, and that this effort would

need to be conducted in coordination with EPA. The additional FCIV would help to incentive a broader suite of highly fuel efficient or electrified vehicles extending upon the basis of that used for full-size pick-ups.

UCS recommended that NHTSA should eliminate flexibilities in the proposal that will undermine the effectiveness of the CAFE program.¹²³⁰ These include reining in the off-cycle credit program, which has led to a significant over-crediting of fuel consumption reduction, and eliminating full-size pick-up incentives, which reward status quo compliance strategies.

EPA decided to finalize a more limited time period for its full-size pickup incentives. The EPA incentive will only be effective for MYs 2023–2024. EPA decided not to finalize the proposed incentives for MYs 2022 or 2025 because it believed a shorter effective period balances the need for flexibility in the near-term with the overall emissions reduction goals of its program. EPA stated that this more targeted approach to full-size pickup truck credits is appropriate to further incentivize advanced technologies in this segment, which continues to be particularly challenging given the need to preserve the towing and hauling capabilities while addressing cost and consumer acceptance challenges. EPA also retained the production thresholds to ensure that manufacturers taking advantage of the flexibility must sell a significant number of qualifying vehicles to do so. While this flexibility is more narrowly focused, since not all manufacturers produce full-size pickups, it represents another avenue for credits that may help manufacturers meet the near-term standards, in addition to the other flexibilities included in EPA's GHG program.

In the interest of maintaining harmonization with the EPA GHG program, NHTSA is adopting the same proposal as EPA and will be extending the CAFE full-size pickup truck incentives for MYs 2023 and 2024. NHTSA believes that maintaining a single compliance approach for the industry is the most effective way to allow this joint incentive to be implemented and maintained by EPA and NHTSA. Further, NHTSA believes that there is merit to incentivizing the production of electric pickup trucks which have historically lagged behind other vehicle classes. We believe that extending the incentive for a short time frame strikes a balance between incentivizing innovation and quicker adoption of advance technology,

without providing a windfall for technologies already saturating the marketplace. Also, given that the agencies are reducing the effective model years for the incentives to only be effective for MYs 2023–2024, NHTSA is finalizing its proposal to allow manufacturers to combine both the incentives for alternative fueled vehicles and full-size pickup trucks FCIVs when complying with the CAFE program for these model years.

(2) Flexibilities for Air Conditioning Efficiency

AC systems are virtually standard automotive accessories, and more than 95 percent of new cars and light trucks sold in the U.S. are equipped with mobile AC systems. AC system usage places a load on an engine, which results in additional fuel consumption; the high penetration rate of AC systems throughout the light-duty vehicle fleet means that more efficient systems can significantly impact the total energy consumed. AC systems also have non-CO₂ emissions associated with refrigerant leakage.¹²³¹ Manufacturers can improve the efficiency of AC systems through redesigned and refined AC system components and controls.¹²³² That said, such improvements are not measurable or recognized using 2-cycle test procedures since AC is turned off during 2-cycle testing. Any AC system efficiency improvements that reduce load on the engine and improve fuel economy is therefore not measurable on those tests.

The CAFE program includes flexibilities to account for the real-world fuel economy improvements associated with improved AC systems and to include the improvements for compliance.¹²³³ The total AC efficiency credits is calculated by summing the individual credit values for each efficiency improving technology used

¹²³¹ Notably, manufacturers cannot claim CAFE-related benefits for reducing AC leakage or switching to an AC refrigerant with a lower global warming potential. While these improvements reduce GHG emissions consistent with the purpose of the CAA, they generally do not impact fuel economy and, thus, are not relevant to the CAFE program.

¹²³² The approach for recognizing potential AC efficiency gains is to utilize, in most cases, existing vehicle technology/componentry, but with improved energy efficiency of the technology designs and operation. For example, most of the additional AC-related load on an engine is because of the compressor, which pumps the refrigerant around the system loop. The less the compressor operates, the less load the compressor places on the engine resulting in less fuel consumption. Thus, optimizing compressor operation with cabin demand using more sophisticated sensors, controls, and control strategies is one path to improving the efficiency of the AC system.

¹²³³ See 40 CFR 86.1868–12.

¹²²⁸ Tesla, NHTSA–2021–0053–1480–A1, at page 9.

¹²²⁹ Volkswagen, NHTSA–2021–0053–1548, at page 21.

¹²³⁰ UCS, NHTSA–2021–0053–1567, at page 3.

on a vehicle, as specified in the AC credit menu. The total AC efficiency credit sum for each vehicle is capped at 5.0 grams/mile for cars and 7.2 grams/mile for trucks. Additionally, the off-cycle credit program contains credit earning opportunities for technologies that reduce the thermal loads on a vehicle from environmental conditions (solar loads or parked interior air temperature).¹²³⁴ These technologies are listed on a thermal control menu that provides a predefined improvement value for each technology. If a vehicle has more than one thermal load improvement technology, the improvement values are added together, but subject to a cap of 3.0 grams/mile for cars and 4.3 grams/mile for trucks. Under its EPCA authority for CAFE, EPA calculates equivalent FCIVs and applies them for the calculation of manufacturer's fleet CAFE values. Manufacturers seeking credits beyond the regulated caps must request the added benefit for AC technology under the off-cycle program discussed in the next section. The agency did not propose any changes its AC efficiency flexibility and therefore will retain its provisions in its current form.

(3) Flexibilities for Off-Cycle Technologies

“Off-cycle” technologies are those that reduce vehicle fuel consumption in the real world, but for which the fuel consumption reduction benefits cannot be fully measured under the 2-cycle test procedures (city, highway or correspondingly FTP, HFET) used to determine compliance with the fleet average standards. The cycles are effective in measuring improvements in most fuel economy improving technologies; however, they are unable to measure or underrepresent certain fuel economy improving technologies because of limitations in the test cycles. For example, off-cycle technologies that improve emissions and fuel economy at idle (such as “stop start” systems) and those technologies that improve fuel economy to the greatest extent at highway speeds (such as active grille shutters which improve aerodynamics) receive less than their real-world benefits in the 2-cycle compliance tests.

In the CAFE rulemaking for MYs 2017–2025, EPA, in coordination with NHTSA, established regulations extending the off-cycle technology flexibility to the CAFE program starting with MY 2017. For the CAFE program, EPA calculates off-cycle FCIVs that are equivalent to the EPA CO₂ credit values and applies them in the calculation of

manufacturer's CAFE compliance values for each fleet instead of treating them as separate credits as for the EPA GHG program.

For determining benefits, EPA created three compliance pathways for the off-cycle program. The first approach allows manufacturers to gain credits using a predetermined approach or “menu” of credit values for specific off-cycle technologies which became effective starting in MY 2014 for EPA.¹²³⁵ ¹²³⁶ This pathway allows manufacturers to use credit values established by EPA for a wide range of off-cycle technologies, with minimal or no data submittal or testing requirements.¹²³⁷ Specifically, EPA established a menu with a number of technologies that have real-world fuel consumption benefits not measured, or not fully measured, by the two-cycle test procedures, and those benefits were reasonably quantified by the agencies at that time. For each of the pre-approved technologies on the menu, EPA established a menu value or approach that is available without testing verifications. Manufacturers must demonstrate that they are in fact using the menu technology, but not required to submit test results to EPA to quantify the technology's effects, unless they wish to receive a credit larger than the default value. The default values for these off-cycle credits were largely determined from research, analysis, and simulations, rather than from full vehicle testing, which would have been both cost and time prohibitive. EPA generally used conservative predefined estimates to avoid any potential credit windfall.¹²³⁸

¹²³⁵ See 40 CFR 86.1869–12(b). The first approach requires some technologies to derive their pre-determined credit values through EPA's established testing. For example, waste heat recovery technologies require manufacturers to use 5-cycle testing to determine the electrical load reduction of the waste heat recovery system.

¹²³⁶ EPA implemented its off-cycle GHG program starting in MY 2012.

¹²³⁷ The Technical Support Document (TSD) for the 2012 final rule for MYs 2017 and beyond provides technology, examples and guidance with respect to the potential pathways to achieve the desired physical impact of a specific off-cycle technology from the menu and provides the foundation for the analysis justifying the credits provided by the menu. The expectation is that manufacturers will use the information in the TSD to design and implement off-cycle technologies that meet or exceed those expectations in order to achieve the real-world benefits of off-cycle technologies from the menu.

¹²³⁸ While many of the assumptions made for the analysis were conservative, others were “central.” For example, in some cases, an average vehicle was selected on which the analysis was conducted. In that case, a smaller vehicle may presumably deserve fewer credits whereas a larger vehicle may deserve more. Where the estimates are central, it would be inappropriate for the agencies to grant greater credit

For off-cycle technologies not on the pre-defined technology list, EPA created a second pathway which allows manufacturers to use 5-cycle testing to demonstrate off-cycle improvements.¹²³⁹ Starting in MY 2008, EPA developed the “five-cycle” test methodology to measure fuel economy for the purpose of improving new car window stickers (labels) and giving consumers better information about the fuel economy they could expect under real-world driving conditions.¹²⁴⁰ As learned through development of the “five-cycle” methodology and prior rulemakings, there are technologies that provide real-world fuel consumption improvements, but those improvements are not fully reflected on the “two-cycle” test. EPA established this alternative for a manufacturer to demonstrate the benefits of off-cycle technologies using 5-cycle testing. The additional emissions test allows emission benefits to be demonstrated over some elements of real-world driving not captured by the two-cycle CO₂ compliance tests including high speeds, rapid accelerations, hot temperatures, and cold temperatures. Under this pathway, manufacturers submit test data to EPA, and EPA determines whether there is sufficient technical basis to approve the off-cycle credits. No public comment period is required for manufacturers seeking credits using the EPA menu or using 5-cycle testing.

The third pathway allows manufacturers to seek EPA review, through a notice and comment process, to use an alternative methodology other than the menu or 5-cycle methodology for determining the off-cycle technology CO₂ credits.¹²⁴¹ Manufacturers must provide supporting data on a case-by-case basis demonstrating the benefits of the off-cycle technology on their vehicle models. Manufacturers may also use the third pathway to apply for credits and FCIVs for menu technologies where the manufacturer is able to demonstrate credits and FCIVs greater than those provided by the menu.

for larger vehicles, since this value is already balanced by smaller vehicles in the fleet. The agencies take these matters into consideration when applications are submitted for credits beyond those provided on the menu.

¹²³⁹ See 40 CFR 86.1869–12(c). EPA proposed a correction for the 5-cycle pathway in a separate technical amendments rulemaking. See 83 FR 49344 (Oct. 1, 2019). EPA is not approving credits based on the 5-cycle pathway pending the finalization of the technical amendments rule.

¹²⁴⁰ <https://www.epa.gov/vehicle-and-fuel-emissions-testing/dynamometer-drive-schedules>. (Accessed: March 15, 2022)

¹²⁴¹ See 40 CFR 86.1869–12(d).

¹²³⁴ See 40 CFR 86.1869–12(b).

(a) The Off-Cycle Approval/Denial Process

In meetings with EPA and manufacturers, NHTSA examined the processes for bringing off-cycle technologies into market. Two distinct processes were identified: (1) The manufacturer's off-cycle pre-production process, and; (2) the manufacturer's regulatory compliance process. During the pre-production process, the off-cycle program for most manufacturers begins as early as four to 6 years in advance of the given model year. Manufacturers' design teams or suppliers identify technologies to develop capable of qualifying for off-cycle credits after careful consideration of the possible benefits. Manufacturer then identify the opportunities for the technologies finding the most optimal condition for equipping the technology given the availability in the production cycle of either new or multiple platforms capitalizing on any commonalities to increase sales volumes and reduce costs. After establishing their new or series platform development plans, manufacturers have two processes for off-cycle technologies on the pre-defined menu list or using 5-cycle testing and for those for which benefits are sought using the alternative approval methodology. For those on the menu list or 5-cycle testing, technologies whose credit amounts are defined by EPA regulation, manufacturers confirm that: (1) New candidate technologies meet regulatory definitions; and (2) for qualifying technologies, there is real fuel economy (FE) benefit based on good engineering judgement and/or testing. For these technologies, manufacturers conduct research and testing independently without communicating with EPA or NHTSA. For non-menu technologies, those not defined by regulation, manufacturers pre-production processes include: (1) Determining the credit amounts based on the effectiveness of the technologies; (2) developing suitable test procedures; (3) identifying any necessary studies to support effectiveness; (4) and identifying the necessary equipment or vehicle testing using good engineer judgement to confirm the vehicle platform benefits of the technology.

While for the regulatory compliance process, the first step for manufacturers begins by providing EPA with early notification in their pre-model year GHG reports (e.g., 2025MY Pre-GHG are due in 2023CY) of their intention to generate any off-cycle credits in accordance with 40 CFR 600.514–12. Next, manufacturers present a brief

overview of the technology concept and planned model types for their off-cycle technologies as a part of annual pre-certification meetings with EPA. Manufacturers typically hold their pre-certification meetings with EPA somewhere between September through November two years in advance of each model year. These meetings are designed to give EPA a holistic overview of manufacturers planned product offerings for the upcoming compliance model year and since 2012 information on the AC and off-cycle programs. Thus, a manufacturer complying in the 2023 compliance model year would arrange its pre-certification meeting with EPA in September 2021 and would be required to share information on the AC and off-cycle technologies its plans to equip during the model year. After this, manufacturers report projected information on off-cycle technologies as a part of their CAFE reports to NHTSA in accordance with 49 CFR part 537 CAFE due by December 31st before the end of the model year.

According to EPA and NHTSA regulations, eligibility to gain benefits for off-cycle technologies only require manufacturers to reporting information in advance of the model year notifying the agencies of a manufacturer's intent to claim credits. More specifically, manufacturers must notify EPA in their pre-model year reports, and in their applications for certification, of their intention to generate any AC and off-cycle credits before the model year, regardless of the methodology for generating credits. Similarly, for NHTSA, manufacturers are also required to provide data in their pre-model year reports required by 49 CFR part 537 including projected information on AC, off-cycle, and full-size pickup truck incentives. These regulations require manufacturers to report information on factors such as the approach for determining the benefit of the technology, projected production information and the planned model types for equipping the off-cycle technology.

If a manufacturer is pursuing credits for a non-menu off-cycle technology, EPA also encourages manufacturers to seek early reviews for the eligibility of a technology, the test procedure, and the model types for testing in advance of the model year. EPA emphasizes the critical importance for manufacturers to seek these reviews prior to conducting testing or any analytical work. Yet, some manufacturers have decided not to seek EPA's early reviews which resulted in significant delays in the process as EPA has had to identify and correct multiple

testing and analytical errors after the fact. Consequently, EPA's goal is to provide approvals for manufacturers as early as possible to ensure timely processing of their credit requests. NHTSA shares the same goals and views as EPA for manufacturers submissions but to-date neither agency has created any required deadlines for these reviews. For NHTSA, its only requirement is for manufacturers to submit copies of all information sent to EPA at the same time.

The next step in the credit review process is for manufacturers to submit an analytical plan defining the required testing to derive the exact benefit of a non-menu off-cycle technology before the model year begins and then to start testing. It is noted that some manufacturers failed to seek EPA's early reviews which delayed finalizing their analytical plans and then the start of their testing. These delays had greater impacts depending upon the required testing for the technology. For example, some manufacturers were required to conduct a four-season testing methodology lasting almost a year to evaluate the performance of a technology during all environmental conditions.

After completing testing, manufacturers are required to prepare an official application requesting a certain amount of off-cycle credits for the technology. In accordance with EPA regulations, the official application request must include final testing data, details on the methodology used to determine the off-cycle credit value, and the official benefit value requested. EPA anticipated that these submissions would be made prior to the end of the model year where the off-cycle technology was applied.

Each manufacturers' application to EPA must then undergo a public notice and comment process if the manufacturer uses a methodology to derive the benefit of a technology not previously approved by EPA. Once a methodology for a specific off-cycle technology has gone through the public notice and comment process and is approved for one manufacturer, other manufacturers may follow the same methodology to collect data on which to base their off-cycle credits. Other manufacturers are only required to submit applications citing the approved methodology, but those manufacturers must provide their own necessary test data, modeling, and calculations of credit value specific to their vehicles, and any other vehicle-specific details pursuant to that methodology, to assess an appropriate credit value. This is similar to what occurred with the

advanced AC compressor, where one manufacturer applied for credits with data collected through bench testing and vehicle testing, and subsequent to the first manufacturer being approved, other manufacturers applied for credits following the same methodology by submitting test data specific for their vehicle models. Consequently, as long as the testing is conducted using the previously approved methodology, EPA will evaluate the credit application and issue a decision with no additional notice and comment, since the first application that established the methodology was subject to notice and comment. EPA issues a decision document regarding the manufacturer's official application upon resolution of any public comments to its **Federal Register** notice and after consultation with NHTSA. Finally, manufacturers submit information after the model year ends on off-cycle technologies and the equipped vehicles in their final CAFE reports due by March 30th and then in their final GHG AB&T reports due to EPA by April 30th.

During the 2020 rulemaking, the agencies and manufacturers both agreed that responding to petitions before the end of a model year is beneficial to manufacturers and the government. It allows manufacturers to have a better idea of what credits they will earn, and for the government, a timely and less burdensome completion of manufacturers' end-of-the-year final compliance processes. EPA structured the AC and off-cycle programs to make it possible to complete the processes by the end of the model year so manufacturers could submit their final reports within the required deadline—90 days after the calendar year, when CAFE final reports are due from manufacturers.¹²⁴²

However, at the time of the previous rulemaking, manufacturers were submitting retroactive off-cycle petitions for review causing significant delays to review and approval of novel technologies and issuances of **Federal Register** notices seeking public comments, where applicable. As a result, the agencies set a one-time allowance that ended in May 2020 for manufacturers to ask for retroactive credits or FCIVs for off-cycle technologies equipped on previously manufactured vehicles after the model year had ended. After that time, the agencies denied manufacturers' late submissions requesting retroactive credits. However, manufacturers who properly submitted information ahead of time were allowed to make

corrections to resolve inadvertent errors during or after the model year.

Both EPA and NHTSA regulations fail to include specific deadlines for manufacturers to meet in finalizing their off-cycle analytical plans or the official applications to the agencies. The agencies believed that enforcing the existing submission requirements would be the most efficient approach to expedite approvals and set aside adding any new regulatory deadlines or additional requirements in the previous rulemaking. There were also concerns to provide manufacturers with maximum flexibility and due to the uncertainties existing with the non-menu off-cycle process. However, the agencies anticipated that any timeliness problems would resolve themselves as the off-cycle program reached maturity and more manufacturers began requesting benefits for previously approved off-cycle technologies.

Despite the agencies' expectations, the lack of deadlines for test results or the official application has significantly delayed approvals for non-menu off-cycle requests. In many cases, EPA has received off-cycle non-menu application requests either late in the model year or after the model year. This falls outside the agencies planned strategy for the off-cycle non-menu review process whereas manufacturers would seek approval and submit their official application requests either in advance of the model year or early enough in the model year to allow the agency to approve a manufacturer's credits before the end of the model year.

(b) Changes to the NHTSA Off-Cycle Program

(i) Review Process

The current review process for off-cycle technologies is causing significant challenges in finalizing end-of-the-year compliance processes for the agencies. The backlog of retro-active and pending late off-cycle requests have delayed EPA from recalculating NHTSA's MY 2017 finals and from completing those for MYs 2018 and 2019. Fifty-four off-cycle non-menu requests have been submitted to EPA to date. Nineteen of the requests were submitted late and another seven apply retroactively to previous model years starting as early as model year 2015. Since these requests represent potential credits or adjustments that will influence compliance figures, CAFE final results cannot be finalized until all off-cycle requests have been decided. These factors have so far delayed MY 2017 final CAFE compliance by 28 months, MY 2018 by 15 months, and MY 2019 by 4 months.

Until EPA verifies final compliance numbers, manufacturers are uncertain about either how many credits they have available to trade or, conversely, how many credits are necessary for them to cover any shortfalls. Therefore, these late reports amount to more than just a mere accounting nuisance for the agencies; they are actively chilling the credit market.

For MY 2017, NHTSA will void manufacturers previous credit trades pending the revised final calculations. Second, until late requests are approved, credit sellers are unable to make trades with buyers having pending approvals or credits are sold whereas the final balance of credits is unknown. Because credit trades and transfers must be adjusted for fuel savings anytime a change occurs in a manufacturer's CAFE values, the resulting earned or purchased credits must be recalculated. These recalculations are significantly burdensome on the government to administer and places an undue risk on manufacturers involved in CAFE credit trade transactions.

NHTSA met with EPA and manufacturers to better understand the process for reviewing off-cycle non-menu technologies. From these discussions, NHTSA identified several issues that may be influencing late submissions. First, non-menu requests are becoming more complex and are requiring unique reviews. Previously approved technologies are also becoming more complex and are requiring either new testing, test procedures or have evolved beyond the definitions which at one time previously qualified them. Next, manufacturers identified the lack of standardized test procedures approved by EPA or certainty from EPA on which model types need to be tested as major sources for delays in submitting their analytical plans. In addition, manufacturers claimed there is significant uncertainty surrounding the necessary data sources to substantiate the benefit of the technology. For example, the data sources necessary to substantiate the usage rates certain technologies in the market. Testing or extrapolating test results for variations in model types can also be difficult and a source of delay. Manufacturers are typically uncertain as to what configurations within a model type must be tested and believe further guidance may be needed by EPA. Manufacturers further claim that it is challenging to coordinate the required testing identified by EPA for off-cycle in coordination with other required certification and emissions testing. Several of these issues were addressed

¹²⁴² 40 CFR 600.512–12.

in the 2020 final rule. In that rulemaking, the agencies stated that developing a standardized test procedure “toolbox” may not be possible due to the development of new and emerging technologies, and manufacturers’ different approaches for evaluating the benefits of the technologies. However, the agencies committed to considering additional guidance, if feasible, as the programs further matures in the review process of technologies and, if possible, identify consistent methodologies that may help manufacturers analyze off-cycle technologies.

Part of the issue is that the review process begins significantly later than the development of technology. Typically, EPA only learns about a new off-cycle technology during manufacturers’ precertification meetings, months or even years after manufacturers started to develop the technology. In the proposal, NHTSA sought comments on whether opportunities exist during the initial development of off-cycle technologies for manufacturers to start discussions with the agencies to identify suitable test procedures or approval of the initial concept of a new technology. After certification meetings, NHTSA also identified that in many cases, manufacturers do not communicate with EPA seeking approvals for their test procedures, test vehicles or credit calculations until anywhere from 3–6 months after the initial development of the technology. Delays in approving a suitable test procedure extends the manufacturers ability to perform testing or to submit its formal request for benefits until after the model year has ended. As mentioned, testing can take up to 12 months after a suitable test procedure and identifying which subconfigurations must be tested.

One manufacturer also stated that set submission deadlines are impossible, agency approvals are variable based on OEM need and reply timing is driven by the EPA. When questioned whether any deadlines could be imposed manufacturers responded believing that any deadlines would need to be negotiated between the manufacturer and the government. NHTSA asked manufacturers to comment on any drawbacks associated with negotiating and enforcing possible off-cycle process deadlines as a part of the proposal.

NHTSA also proposed to modify the eligibility requirements for non-menu off-cycle technologies in the CAFE program starting in model year 2024. NHTSA proposed for manufacturers to finalize their analytical plans by December before the model years and

their final official technology credit requests by September during the model year. It was also proposed for manufacturers to meet the proposed deadlines or be subject an enforcement action unless an extension was granted by NHTSA for good cause. Otherwise, a manufacturer would be precluded from claiming any off-menu items not timely submitted. Failure to request extensions or meet negotiated deadlines would be subject to enforcement action in compliance with 49 U.S.C. 32912(a).

To further streamline the process of reviews, NHTSA also proposed to work with EPA to create a quicker process for adding off-cycle technologies to the predetermined menu list if widely approved for multiple manufacturers. For example, the agencies added high-efficiency alternators and advanced AC compressors to the menu allowing manufacturers to select the menu credit rather than continuing to seek credits through the public approval process. High-efficiency alternators were added to the off-cycle credits menu, and advanced AC compressors with a variable crankcase valve were added to the menu for AC efficiency credits. The credit levels are based on data previously submitted by multiple manufacturers through the off-cycle credits application process. The high efficiency alternator credit is scalable with efficiency, providing an increasing credit value of 0.16 grams/mile CO₂ per percent improvement as the efficiency of the alternator increases above a baseline level of 67 percent efficiency. The advanced AC compressor credit value is 1.1 grams/mile for both cars and light trucks.¹²⁴³

Several comments were received in response to the NPRM. Commenters included several trade and environmental groups including Auto Innovators, ACEEE, the ITB Group and NADA as well as vehicle manufacturers including Ford, Hyundai and Stellantis.

Auto Innovators commented that time is of the essence when a manufacturer submits an off-cycle credit application for review. Lengthy delays in processing applications and in reviews subsequent to the public notice and comment process introduce uncertainty into compliance planning and reporting for manufacturers. Delays also affect timely determinations of compliance and valuation of credit trades and transfers. They also discourage further investments in off-cycle technologies

¹²⁴³ For additional details regarding the derivation of these credits, see EPA’s Memorandum to Docket EPA–HQ–OAR–2018–0283 (“Potential Off-cycle Menu Credit Levels and Definitions for High Efficiency Alternators and Advanced Air Conditioning Compressors”).

due to the uncertainty of when (or if) credit will ever be granted.

Auto Innovators further explained that EPA is required to review an application for completeness and to notify the submitting manufacturer if additional information is required within 30 days. Subsequent to determining an application is complete, EPA is required to make the application available to the public for comment within 60 days. These two processes should collectively take a maximum of 90 days. Thus far in 2021, three applications that reached publication in the **Federal Register** took 111, 290, and 342 days. Other applications are still pending review or publication for public comment. Auto Innovators urged EPA to follow its regulations by providing an initial response on the completeness of credit applications within 30 days and to make complete applications available for public comment within 60 days. Auto Innovators commented that once the public comment period closes, the EPA decision process is also frequently lengthy. For example, Auto Innovators claimed EPA published off-cycle credit applications for public comment from Toyota in April 2020 and in October 2020, Nissan in February 2021, and from Stellantis in April 2021, and as of their comment submission, all three were still pending a decision.

NHTSA is also proposing to impose new deadlines associated with off-cycle technology FCIVs applied for under the “alternative method” pathway. Although, Auto Innovators agrees that implementation of the alternative method pathway has been time-consuming and has not met the expectations of the agencies, automobile manufacturers, and suppliers, it is unclear if the imposition of additional deadlines will result in improvements, or simply add additional administrative burden to an already cumbersome process. Auto Innovators stated that the agencies already took steps to improve the timeliness of the process in the 2020 SAFE rule and that NHTSA should allow these process improvements to play out before imposing additional, unilateral deadlines.

American Council for an Energy Efficient Economy (ACEEE) commented it supports adding a firm time limit on automaker applications to the non-menu off-cycle credit program. They claim that this program has long been plagued by automaker applications for technologies implemented on old vehicle models. These retroactive requests have no bearing on current OEM technology decisions and cost a significant amount of time to process.

Lastly, they make setting future standards difficult, as actual contemporary compliance is not set in stone. Requiring automakers to submit their requests for off-cycle credits in a timely manner would improve the effectiveness of the off-cycle program. For these reasons ACEEE supports NHTSA in its proposed time limit on application for non-menu off cycle credit applications.

The ITB Group also supported NHTSA efforts for streamlining the off-cycle credit approval process. The ITB Group agreed with NHTSA that the off-cycle credit approval process can be improved. NHTSA proposed setting deadlines for OEM submissions, and the ITB Group suggests that there should also be deadlines for the agencies (EPA/NHTSA) to respond to off-cycle credit request submissions for the off-menu approval pathways. The ITB Group also recommends the development of a formal process for adding technologies to the menus and adjusting menu credits when necessary.

The National Automobile Dealers Association (NADA) commented sharing the same concerns expressed by Auto Innovators regarding the changes proposed by NHTSA.

Ford submitted comments supporting NHTSA's goal for more timely resolution of "Demonstration" off-cycle credit applications. Ford commented that EPA already codified requirements in 40 CFR 86.1869-12 for manufacturers to submit a detailed analytical plan prior to the model year in which a manufacturer intends to seek these credits and for EPA to make the demonstration applications available for public review within 60 days of receiving a completed application. Ford believed that NHTSA can make the most meaningful impact to improve the process through internal review with EPA rather than imposing additional deadlines on manufacturers.

Hyundai commented that the off-cycle alternative process involves testing and assessment of new and novel technologies which reduce fuel consumption. While this process remains complicated, Hyundai recognized that some improvements were made to the off-cycle credit approval process in the 2020 rulemaking to address procedural issues. And Hyundai appreciated that the agencies continue to pursue improvements, such as "considering additional guidance" and to, "if possible, identify consistent methodologies that may help manufacturers analyze off-cycle technologies."

Hyundai is one of several auto manufacturers who have long-pending applications, some from 2020. Speedy reviews are critical to automakers to ensure that investments in technologies are implemented in a timely manner. Long application review and approval timelines for technologies using the alternative process cause uncertainty about the number of credits manufacturers earned for each model due to unresolved applications. Manufacturers may not know if they will be in a position to buy or to sell credits until all applications are resolved. Manufacturers may also need to resubmit final model year reports once extended approval processes are resolved. This is inefficient and creates additional work for both the agency and the automakers.

In its comments to the EPA on their GHG NPRM, Hyundai called on both auto manufacturers and the agency to be held to timing requirements. Automakers should submit off-cycle applications in a timely manner. Similarly, the EPA should make applications available for a 30-day public comment period within 90 days of the manufacturers' submission and then establish a reasonable timeline to issue a decision on the applications. Hyundai recommends 60 days for the agency to review after the public comment period closes. This would result in a maximum review period of 180 days which would be timelier than the approval length for some current applications.

Further Hyundai responded to NHTSA's request for comment on whether there are opportunities to engage earlier in the off-cycle technology development process with manufacturers. Hyundai stated it welcomes the opportunity to improve the approval process by discussing technology and test procedures with the agency earlier, however this is only possible once the development process has progressed to a point where the technology has reached a certain maturity, thus having these conversations earlier may not be possible in all cases.

Furthermore, Hyundai stated that in some off-cycle technology testing NHTSA's new timing proposal includes a requirement that automakers deliver analytical plans to the agency by December before the model year and deliver the final official technology credit request by September during the model year may not be suitable. For some applications, the agency may need a full year (12 months) of fleet-level data to support the technology credit request. This full year of data provides extensive

on-road vehicle information under different weather conditions to prove-out an applied technology's real-world benefits. In some cases, the proposed September delivery target precludes a full year of data collection. For example, a 2022 model year vehicle could begin production in June 2022 and require data to be submitted in September 2022, just three months after production begins. In this example, it is not possible to provide a full 12 months of fleet level supporting data. Hyundai requests that the agency clarify how they would accommodate this type of situation and structure the process to allow auto manufacturers to fulfill all of the agencies' requirements within the newly proposed application deadline.

Hyundai also responded to NHTSA's other comment request on drawbacks associated with enforcing strict deadlines for off-cycle applications. Hyundai stated while it recognizes and shares the agencies frustration that the off-cycle approval process can be protracted, we caution that strict enforcement will lead some automakers to reduce investment in off-cycle credit technologies. If manufacturers are uncertain that they will receive proper credit for the inclusion of these fuel saving technologies, they may decide they cannot justify the investment in research and development of new technologies resulting in lost real-world fuel efficiency improvements. Hyundai requested that NHTSA develop an extension process to facilitate the inherent flux of the development process for these advanced technologies.

Stellantis commented that the agency is proposing to remove menu credit for technologies that impact OEMs as soon as MY2023. Recovering this lost credit outside of the menu is infeasible since the alternative methodology off-cycle application submission process can take a year or longer with uncertain outcome. There are a large number of off-cycle industry applications awaiting action by agency staff. While some of this is certainly due to COVID-19 challenges, the overall lack of movement is concerning. OEMs have yet to be asked technical questions on many applications, and, when responses have been requested and supplied, it is unclear of what happens next.

Stellantis commented that one improvement that would certainly help would be to set up a system to make the alternative methodology application process more transparent. It would be useful if the agencies could report the non-confidential status of all off-cycle alternative methodology applications on a quarterly basis to industry.

Stellantis also proposed that a notice of availability be published in the **Federal Register** for all off-cycle alternative methodology applications after 90 days if the agency has not yet completed the review of the application for completeness, and if applicable, notify the applicant of additional information being required. This review and communication back to the applicant is required to happen within 30 days of submission. Automatically publishing the application after 90 days (three times the length of the required review period) will allow the public comment period to begin and will help this process function as intended.

Stellantis suggested that NHTSA work to align all off-cycle reporting processes with EPA and not introduce additional burdens on timing with different reporting timelines or new safety considerations upon the system that is already constrained.

Stellantis is willing to solicit industry to partner with the agencies to help identify and implement process improvements to evaluate and decision applications more quickly.

For industry awareness, NHTSA meets with EPA on a biweekly basis to consult on non-menu off-cycle requests from manufacturers. Based upon our interactions and knowledge of potential barriers learned to date, NHTSA has decided for its final rule to retain its deadlines and enforcement actions proposed in the NPRM and to add additional internal administrative processes to better facilitate the off-cycle program. More specifically, NHTSA plans to implement the same monitoring processes it uses for its safety enforcement programs. This involves creating a public case file, which is the official record of all communication and records between an entity and the government. NHTSA will use these case files for evaluating any extension requests from manufacturers and as the basis for any process changes to its off-cycle program in future rulemakings. We believe this administrative process will also help to identify any delays in complying with 40 CFR 86.1869–12(e)(3)(i) and (iii), which Auto Innovators and Stellantis commented collectively should take a maximum of 90 days but to date have taken far longer. Although not officially documented, we are aware that notifying manufacturers for additional information within 30 days is a longer process because usually several requests are needed before all the required information is obtained by EPA to determine that an application is complete.

At present, the agencies share an unofficial simplified spreadsheet for tracking off-cycle requests which is discussed during each joint biweekly meeting. Consequently, we do believe manufacturers concerns have some legitimacy concerning the timing in issuing **Federal Register** notices. However, it was for these reasons EPA adopted changes in their 2020 SAFE rule allowing them to forgo issuing **Federal Register** notices for technologies that have been previously approved. In addition, we note that these delays exist, as noted by commenters, because the agencies allowed manufacturers to claim retroactive off-cycle credits until May 2020, which has created a backlog of requests drastically delaying processing other requests. As indicated by Auto Innovators, the agencies are allowing these retroactive requests to play out before imposing additional actions such as possible cut-off dates.

In the future, NHTSA is considering adding additional requirements to help resolve delays in the requirement for EPA to notify manufacturers of its decision within 60 days of receiving a complete application as required in 40 CFR 86.1869–12(e)(4)(i). NHTSA has identified that some manufacturers have significant delays in responding back to EPA after requests for additional information have been made. Rarely does EPA receive all the information it needs to complete the manufacturers application and make its decision within 60 days. In some instances, manufacturers have even failed to respond to EPA for over a month, cutting considerably into the 60-day response timeline. NHTSA is considered adding a deadline requirement in the future for responding back to the agencies which would serve as criteria for denying a manufacturer's request, although as requested by Stellantis, we believe more transparency and better official tracking between the government and manufacturers is a more feasible approach at this time.

We will also attempt to develop a public report to track approved or disapproved off-cycle requests on the NHTSA PIC site and will host at least one compliance meeting annually with interested parties to share our case files and discuss other potential improvements to the off-cycle processes. NHTSA and EPA will also take steps to explore formal processes for adding technologies to the menus and adjusting menu credits when necessary. Finally, since some requests need a full year (12 months) of fleet-level data to support the technology credit request (such as extensive on-road vehicle information

under different weather conditions), which may extend beyond NHTSA's September deadline, NHTSA requests automakers to consider submitting these off-cycle applications ahead of time. NHTSA will track manufacturer submissions, and should the manufacturers fail to meet NHTSA's deadline requirements, manufacturers will need to provide sufficient documentation explaining their missed deadline in order to request an extension.

(ii) Safety Assessment

In the 2016 heavy-duty fuel economy rule (81 FR 73478, Oct. 25, 2016), NHTSA adopted provisions preventing manufacturers from receiving off-cycle credits for technologies that impair safety—whether due to a defect, negatively affecting a FMVSS, or other safety reasons.¹²⁴⁴ Additionally, NHTSA clarified that technologies that do not provide fuel savings as intended will also be stripped of credits. To harmonize the light-duty and heavy-duty off-cycle programs, NHTSA proposed to adopt these provisions for the light-duty CAFE program as a part of its 2021 NPRM.¹²⁴⁵ While the agency encourages fuel economy innovations, safety remains NHTSA's primary mission and any technology applied for CAFE-purposes should not impair safety. Furthermore, adopting these requirements for the light-duty fleet will harmonize it with regulations for heavy-duty vehicles.

In response to the proposal, Auto Innovators commented opposing NHTSA's new processes for reviewing applications for off-cycle fuel economy improvement credits in order to assess the safety of the proposed technology and to remove credits if a safety defect is identified. Auto Innovators understands that NHTSA's primary mission is safety and applauds the agency's commitment to ensuring that technology intended to enhance fuel efficiency does not impair safety. However, it explained that NHTSA's proposal goes too far—a technology can be “defective” for reasons unrelated to safety or fuel economy. NHTSA's criterion “identified as a part of NHTSA's safety defects program” is unclear, as is the context of “performing as intended.” The proposal to require manufacturers applying for off-cycle credits to state that each vehicle equipped with the off-cycle technology will comply with all applicable Federal Motor Vehicle Safety Standards (FMVSS) is unnecessary, and it is

¹²⁴⁴ See 49 CFR 535.7(f)(2)(iii).

¹²⁴⁵ 86 FR 49602 (Sept. 3, 2021).

unclear how the requirement to describe fail-safe provisions will work as a practical manner.

The National Automobile Dealers Association (NADA) commented sharing its support for Auto Innovators' opposition to NHTSA's proposed safety provisions.

Hyundai commented that NHTSA's provisions are not necessary because every vehicle sold in the United States is already designed with safety in mind and complies with all applicable FMVSS safety rules. Further, there are processes in place to address any component failures that may impact safety.

Lucid commented stating that it supports NHTSA's proposal to rescind credits for off-cycle technologies that are found to be defective or otherwise impair vehicle safety, as is NHTSA's practice in the heavy-duty context. This proposal recognizes and puts into practice NHTSA's mission of preserving vehicle safety and ensures that manufacturers are not unduly rewarded for innovations that ultimately make their vehicles less safe.

In response to Auto Innovators' and NADA's concerns, we note that the new requirement does not change the certification process or awarding of OC credits. As noted in the proposal, this new provision would only take effect after a safety defect was discovered. We also note that OC technologies are intended to improve fuel economy, and that awarding defective technology that does not improve off-cycle fuel efficiency undermines the program. NHTSA experience with its heavy-duty program has proven that manufacturers can comply with these provisions. Addressing safety is just as critical to manufacturers as it is to NHTSA and all manufacturers had fail-safe designs which they identified with their heavy-duty application requests. We plan to use our existing enforcement processes administered by the Office of Defects Investigations and the Office of Vehicle Safety Compliance to identify potentially or existing safety concerns with fuel efficiency technologies. For example, NHTSA will search through vehicle owner complaints, manufacturer's warranty claims, internet information and part 573 recalls submitted by manufacturers for safety related problems involving incentivized fuel efficiency technologies. Should a recall result or exist, it will be necessary for the manufacturer to remedying all the defective or non-compliant equipment in order to maintain its fuel efficiency credits for an off-cycle technology regardless of whether the safety problem has a direct bearing on

fuel savings. Otherwise, the credits will be removed or adjusted to the number of remedied vehicles. NHTSA believes that that these provisions will ensure that emphasis remains on protecting the safety of vehicle occupants for both the Government and for motor vehicle manufacturers.

(iii) Menu Credit Cap

In the NPRM, NHTSA proposed a temporary increase in the off-cycle menu credit cap from 10 to 15 g/mile from MY 2023 through 2026 to align with the EPA GHG program. Coinciding with the increased menu cap, NHTSA proposed adopting revised definitions for certain off-cycle menu technologies in order to better capture real-world GHG emission improvements of specific menu technologies.

Due to the uncertainties associated with combining menu technologies and the fact that some uncertainty is introduced because off-cycle credits are provided based on a general assessment of off-cycle performance, as opposed to testing on the individual vehicle models, NHTSA and EPA established caps that limit the amount of credits a manufacturer may generate using the off-cycle menu list. Historically EPA and NHTSA have capped off-cycle menu technologies at 10 grams/mile per year on a combined car and truck fleet-wide average basis. In its most recent rulemaking for MYs 2023–2026 GHG standards, EPA finalized the increase in the off-cycle menu cap from 10 grams CO₂/mile to 15 grams CO₂/mile beginning with MY 2023. EPA also revised the definitions for passive cabin ventilation and active engine and transmission warm-up beginning in MY 2023, as discussed in the next following sections. EPA did not retroactively adopt these provisions for MY 2020–2022 as originally proposed in their GHG NPRM. NHTSA is aligning with the EPA GHG program and adopting the same provision to increase the off-cycle menu technology cap to 15 g/mile and adopting the new definitions of active transmission warm-up and passive cabin ventilation for MYs 2023–2026. Credits established under the 5-cycle and petitioning pathways do not count against the menu cap.

The agency received comments in support and opposition to the increase of the menu credit cap to 15g/mile. Some manufacturers and suppliers supported the increase, while others expressed opposition. Toyota, Nissan, Stellantis, the ITB Group, Auto Innovators, MECA, and Borg Warner all agreed with the agency's direction to increase the cap, stating the credit cap should continue to increase as new

technologies are added to the menu.¹²⁴⁶ Stellantis contends that the increased credit cap will further incentivize the industry to adopt these technologies across fleets and that these technologies have a real benefit to fuel economy. ACEEE, Tesla, and Lucid oppose the increase to the menu credit cap.¹²⁴⁷ Tesla stated that the off-cycle program creates an asymmetry in the regulations which favor internal combustion engines and effectually diverts R&D resources to the creation and improvement of legacy ICE technologies that are less efficient than electrified powertrains. Additionally, these organizations state that increasing the menu credit cap adds additional compliance flexibilities with questionable improvements to real world efficiency.

NHTSA appreciates the feedback from the manufacturers and industry stakeholders. NHTSA disagrees that the off-cycle program provides an asymmetrical benefit to internal combustion manufacturers. Off-cycle credits are designed to reward real-world emissions reductions missed through 2-cycle testing and the agency has a duty to honor the most accurate fuel economy performances from each manufacturer in order to issue final compliance to Federal fuel economy standards. We believe that off-cycle is a viable route to achieving fuel economy improvements, and if there are any incongruities between awarded credits and technology efficacy, then the solution should be to address the source of the discrepancy rather than scrapping the program.

NHTSA acknowledges that certain credits and flexibilities may be more beneficial to certain technologies but does not believe that this warrants the elimination of the off-cycle program at this time. NHTSA further notes that commenters who asked the agency to lower or eliminate off-cycle credits because it 'favored' ICE simultaneously supported providing more incentives for electric pathways. The objective of CAFE is to reduce the Nation's dependency on oil, not to promote a particular technology pathway. Manufacturers are free to set their compliance pathways and can chose to invest in technologies other than off-

¹²⁴⁶ Toyota, NHTSA–2021–0053–1568, at page 20; Nissan, NHTSA–2021–0053–0022–A1 at page 7; Stellantis, NHTSA–2021–0053–1527, at page 32; ITB Group, at NHTSA–2021–0053–0019–A1, at page 7; Auto Innovators, NHTSA–2021–0053–1492, at page 124.; MECA, NHTSA–2021–0053–1113 at page 3; BorgWarner, at page 2.

¹²⁴⁷ ACEEE, NHTSA–2021–0053–0074, at page 6.; Tesla, NHTSA–2021–0053–1480–A1, at page 10; Lucid, NHTSA–2021–0052–1584 at page 6.

cycle technologies. ICE vehicles sold during the years covered by this final rule will remain on the road for decades to come and creating an incentive to have manufacturers making those vehicles more fuel efficient is beneficial to consumers—including those who may purchase the vehicle a decade or later after the vehicle was manufactured—and reduces the Nation's carbon emissions.

For the final rule, NHTSA is adopting provisions that align with the EPA's program in terms of increasing the off-cycle menu cap to 15 g/mile in MY 2023 and extending through MY 2026. Off-cycle technologies are often more cost effective than other available technologies that reduce vehicle GHG emissions over the 2-cycle tests and manufacturers use of the program continues to grow. Off-cycle credits reduce program costs and provide additional flexibility in terms of technology choices to manufacturers which has resulted in many manufacturers using the program. Multiple manufacturers were at or approaching the 10 g/mile credit cap in MY 2019.¹²⁴⁸ Also, in the SAFE rule, EPA added menu credits for high efficiency alternators but did not increase the credit cap for the reasons noted above.¹²⁴⁹ While adding the technology to the menu has the potential to reduce the burden associated with the credits for both manufacturers and the agencies, it further exacerbates the credit cap issue for some manufacturers. Increasing the cap provides an additional optional flexibility and also an opportunity for manufacturers to earn more menu credits by applying additional menu technologies that will improve fuel efficiency.

(iv) Definitions

(a) Passive Cabin Ventilation

In the NPRM, the agency proposed a revision to the passive cabin ventilation definition to make it consistent with the technology used to generate the credit value. The credits for passive cabin ventilation were originally determined based on an NREL study that strategically opened a sunroof where hot air collects to allow for the unrestricted flow of heated air to exit the interior of the vehicle while combined with additional floor openings to provide a minimally restricted entry for cooler

ambient air to enter the cabin. The modifications that NREL performed on the vehicle reduced the flow restrictions for both heated cabin air to exit the vehicle and cooler ambient air to enter the vehicle, creating a convective airflow path through the vehicle cabin.

As noted in the Joint TSD for the 2012 final rule:

For passive ventilation technologies, such as opening of windows and/or sunroofs and use of floor vents to supply fresh air to the cabin (which enhances convective airflow), (1.7 g/mile for light-duty vehicles and 2.3 g/mile for light-duty trucks) a cabin air temperature reduction of 5.7 °C can be realized.¹²⁵⁰

The passive cabin ventilation credit values were based on achieving the 5.7 °C cabin temperature reduction.

Some manufacturers have claimed the passive cabin ventilation credits based on the addition of software logic to their HVAC system that sets the interior climate control outside air/recirculation vent to the open position when the power to vehicle is turned off at higher ambient temperatures. The manufacturers have claimed that the opening of the vent allows for the flow of ambient temperature air into the cabin. While opening the vent may ensure that the interior of the vehicle is open for flow into the cabin, no other action is taken to improve the flow of heated air out of the vehicle. This technology relies on the pressure in the cabin to reach a sufficient level for the heated air in the interior to flow out through body leaks or the body exhausters to open and vent heated air out of the cabin.

Analytical studies performed by manufacturers evaluating the performance of the open dash vent demonstrate that while the dash vent may allow for additional airflow of ambient temperature air entering the cabin, it does not reduce the existing restrictions on heated cabin air exiting the vehicle, particularly in the target areas of the occupant's upper torso. That hotter air generally must escape through restrictive (by design to prevent water and exhaust fumes from entering the cabin) body leaks and occasional venting of the heated cabin air through the body exhausters. While this may provide some minimal reduction in cabin temperatures, this open dash vent technology is not as effective as the combination of vents used by the NREL researchers to allow additional ambient temperature air to enter the cabin and also to reduce the restriction of heated air exiting the cabin.

In response to the agency's proposal to redefine passive cabin ventilation off-cycle menu technology, industry stakeholders provided feedback in support and opposition to the proposed change. The ITB Group and the Union of Concerned Scientists both wrote in support of the change to the Passive Cabin Ventilation definition, stating that menu definitions should be supported by representative data.¹²⁵¹ Stellantis, Nissan, Auto Innovators, and JLR all argued against the agency's plan to change the passive cabin ventilation definition stating that the timing of this definition change would prevent manufacturers from gaining credits for technology already installed on vehicles.¹²⁵² Auto Innovators, Stellantis, Nissan, and Toyota all stated the lead-time for the adoption of the new passive cabin ventilation was a concern.¹²⁵³ Commenters stated that to effectively meet the new definition, vehicles would need to be redesigned which would take years to implement, thus offsetting manufacturers' compliance strategies for several years to come. Several commenters, including JLR, stated that the agency should consider some off-cycle credit for those vehicles that meet the passive cabin ventilation as previously written, since technologies already installed on vehicles provide some level of real-world fuel efficiency benefits and should be considered for menu credit. The ITB Group identified a risk in adopting a new technology definition, as some manufacturers may decide to remove passive cabin ventilation technologies currently applied to fleets; technologies that provide some real-world benefits but do not meet the new technology definition, thus increasing fleet emissions.

The agency appreciates the comments provided by industry stakeholders and understands the strain this definition change will put on manufacturers who currently do not meet the standards of the new definition. NHTSA disagrees with comments that the agency should continue to allow the use of the unrevised definitions and menu credits for several model years into the future. Allowing manufacturers to claim fuel economy off cycle credit for a technology that does not produce real-world benefits at the level prescribed in the menu of off-cycle technologies effectively reduces the stringency of the standard and inequitably benefits those

¹²⁴⁸ In MY 2019, Ford, FCA, and JLR reached the 10 g/mile cap and three other manufacturers were within 3 g/mile of the cap. See "The 2020 EPA Automotive Trends Report, Greenhouse Gas Emissions, Fuel Economy, and Technology since 1975," EPA-420-R-21-003 January 2021.

¹²⁴⁹ 85 FR 25236 (Apr. 30, 2020).

¹²⁵⁰ 2012 TSD at 584.

¹²⁵¹ ITB Group, at NHTSA-2021-0053-0019-A1, at p. 3; UCS, NHTSA-2021-0053-1567, at p. 14.

¹²⁵² Stellantis, NHTSA-2021-0053-1527, at p. 32; Nissan, NHTSA-2021-0053-0022-A1, at p. 8; Auto Innovators, NHTSA-2021-0053-1492, at p. 59; JLR, NHTSA-2021-0053-1505, at pp. 7-8.

¹²⁵³ Toyota, NHTSA-2021-0053-1568, at p. 22.

manufacturers who apply technology that does not meet the intent of the rule. For example, when establishing the passive cabin ventilation credit, EPA envisioned air flow consistent with windows and/or sunroof being open for a period of time to allow hot air to escape the cabin through convective air flow. Under the original definitions, manufacturers are generating a sizeable credit for simply opening the interior vents when the vehicle is keyed off. With respect to the comments received on the application timing of this definition, the agency has provided more than the statutorily mandated minimum of 18 months lead time. The agency believes that 18 months is sufficient lead time for manufacturers to reconfigure their compliance plans.

NHTSA is finalizing revisions to the passive cabin ventilation definition with clarifying edits to make it consistent with the technology used to generate the credit value. The agency continues to allow for innovation as the definition includes demonstrating equivalence to the methods described in the Joint TSD. As proposed, NHTSA is revising the definition of passive cabin ventilation to include only methods that create and maintain convective airflow through the body's cabin by opening windows or a sunroof, or equivalent means of creating and maintaining convective airflow, when the vehicle is parked outside in direct sunlight. Current systems claiming the passive ventilation credit by opening the dash vent do not meet the updated definition. Manufacturers seeking to claim credits for the open dash vent system will be eligible to petition the agency for credits for this technology using the alternative EPA approved method outlined in 40 CFR 86.1869–12(d).

(b) Active Engine and Transmission Warmup

As proposed in 2021 NPRM, NHTSA is revising the menu credit definition of active engine and transmission warmup to no longer allow systems that capture heat from the coolant circulating in the engine block prior to the opening of the thermostat to qualify for the Active Engine and Active Transmission warm-up menu credits.

In the NPRM for the 2012 final rule,¹²⁵⁴ EPA proposed capturing waste heat from the exhaust and using that heat to actively warm up targeted parts of the engine and the transmission fluid. The exhaust waste heat from an internal combustion engine is heat that is not being used as it is exhausted to the

atmosphere. In the 2012 final rule,¹²⁵⁵ the agency revised the definitions for active engine and transmission warm-up by replacing exhaust waste heat with the waste heat from the vehicle. The agencies concluded that other methods, in addition to waste heat from the exhaust, that could provide similar performance—such as coolant loops or direct heating elements—may prove to be a more effective alternative to direct exhaust heat. Therefore, the agencies expanded the definition in the 2012 final rule.

All agency analysis regarding active engine and transmission warm-up through the 2012 final rule was performed assuming the waste heat utilized for these technologies would be obtained directly from the exhaust prior to being released into the atmosphere and not from any engine-coolant-related loops. At this time, many of the systems in use are engine-coolant-loop-based and are taking heat from the coolant to warm-up the engine oil and transmission fluid.

We provided additional clarification on the use of waste heat from the engine coolant in preamble to SAFE rule.¹²⁵⁶ We focused on systems using heat from the exhaust as a primary source of waste heat because that heat would be available quickly and also would be exhausted by the vehicle and otherwise unused.¹²⁵⁷ Heat from the engine coolant already may be used by design to warm up the internal engine oil and components. That heat is traditionally not considered “waste heat” until the engine reaches normal operating temperature and subsequently requires it to be cooled in the radiator or other heat exchanger.

We allowed for the possible use of other sources of heat such as engine coolant circuits, as the basis for the credits as long as those methods would “provide similar performance” as extracting the heat directly from the exhaust system and would not compromise how the engine systems would heat up normally absent the added heat source. However, the SAFE rule also allowed us to require manufacturers to demonstrate that the system is based on “waste heat” or heat that is not being preferentially used by the engine or other systems to warm up other areas like engine oil or the interior cabin. Systems using waste heat from the coolant do not qualify for credits if their operation depends on, and is delayed by, engine oil temperature or interior cabin temperature. As the

engine and transmission components are warming up, the engine coolant and transmission oil typically do not have any “waste” heat available for warming up anything else on the vehicle since they are both absorbing any heat from combustion cylinder walls or from friction between moving parts in order to achieve normal operating temperatures. During engine and transmission warm-up, the only waste heat source in a vehicle with an internal combustion engine is the engine exhaust, as the transmission and coolant have not reached warmed-up operating temperature and therefore do not have any heat to share.¹²⁵⁸

In the NPRM, NHTSA proposed revising the menu definition to align with the EPA definition of active engine and transmission warm-up to no longer allow systems that capture heat from the coolant circulating in the engine block to qualify for the Active Engine and Active Transmission warm-up menu credits.

In response to the NPRM, NHTSA received comments with respect to the proposed new definition. The Union of Concerned Scientists commented in support of updating the definition, stating the technologies,¹²⁵⁹ as currently defined, allow manufacturers to claim undue credit for technologies that produce real-world fuel efficiency benefits less than the menu credit amount. Auto Innovators, Nissan, Stellantis, and JLR wrote in opposition to the proposed definition change, stating the lead time as one of the reasons to not adopt the change.¹²⁶⁰ Commentors stated that this change leaves less than 1 year to implement a design change to satisfy the new definition which is not reasonable. The ITB Group commented that the new definition should not be limited to only exhaust waste heat but include any technology that can rapidly warm an engine, including a zero-coolant flow program to result in rapid warm-up.¹²⁶¹ Nissan stated that redefining the menu technology will increase the number of alternative methodology off-cycle requests for lesser amounts of fuel economy credit. Nissan, JLR, the ITB Group, The Alliance, Stellantis, and Toyota¹²⁶² recommended the agency honor some lesser fuel economy credit

¹²⁵⁸ 85 FR 25240 (Apr. 30, 2020).

¹²⁵⁹ UCS, NHTSA–2021–0053–1567, at p. 14.

¹²⁶⁰ Auto Innovators, NHTSA–2021–0053–1492, at p. 59.; Nissan, NHTSA–2021–0053–0022–A1, at p. 8; Stellantis, NHTSA–2021–0053–1527, at p. 32; JLR, NHTSA–2021–0053–1505, at pp. 7–8.

¹²⁶¹ ITB Group, at NHTSA–2021–0053–0019–A1, at p. 3.

¹²⁶² Nissan; JLR; ITB Group; Auto Innovators; Stellantis; Toyota.

¹²⁵⁵ 77 FR 62624 (Oct. 15, 2012).

¹²⁵⁶ 85 FR 24174 (Apr. 30, 2020).

¹²⁵⁷ 85 FR 25240 (Apr. 30, 2020).

¹²⁵⁴ See 2011 NPRM, 76 FR 74854 (Dec. 1, 2011).

amount for technologies that meet the current definition.¹²⁶³ Toyota recognized the agency's rationale for updating the technology definitions but requested that an application date for new definitions be delayed until the 2025 MY in order to implement new vehicle designs.

NHTSA appreciates the feedback from the industry and stake holders. NHTSA disagrees with extending the definition to include technologies that do not rely on waste exhaust heat; the lack of specific text requiring exhaust heat recovery resulted in many manufacturers utilizing extended coolant pathways which did not result in real-world benefits commensurate with the intent of the technology or menu credits, real-world benefits which are lesser than recovering exhaust heat.

As proposed in the NPRM, NHTSA is revising the menu definition to align with the EPA definition of active engine and transmission warm-up to no longer allow systems that capture heat from the coolant circulating in the engine block to qualify for the Active Engine and Active Transmission warm-up menu credits. NHTSA will allow credit for coolant systems that capture heat from a liquid-cooled exhaust manifold if the system is segregated from the coolant loop in the engine block until the engine has reached fully warmed-up operation. The agency will also allow system design that captures and routes waste heat from the exhaust to the engine or transmission, as this was the basis for these two credits as originally proposed in the proposal for the 2012 rule. The approach NHTSA and EPA have finalized will help ensure that the level of menu credits is consistent with the technology design envisioned by the agencies when it established the credit in the 2012 rule. This revision to the technology definition will apply starting in MY 2023.

Manufacturers seeking to utilize their existing systems that capture coolant heat before the engine is fully warmed-up and transfer this heat to the engine oil and transmission fluid would remain eligible to seek credits through the alternative method application process outlined in 40 CFR 86.1869–12(d). We expect that these technologies may provide some benefit, though not the level of credits included in the menu. But, as noted above, since these system designs remove heat that is needed to warm-up the engine the agency expects

that these technologies will be less effective than those that capture and utilize exhaust waste heat.

(4) Other Credits Suggested by Commenters

Securing America's Future Energy provided comments stating that it believes that connected and automated vehicles (CAVs) have tremendous potential to increase efficiencies and save fuel.¹²⁶⁴ Securing America's Future Energy encouraged NHTSA and EPA to update the approach to off-cycle credits, while considering several potential improvements tailored to accommodate truly innovative technologies. Securing America's Future Energy commented most of savings of these CAVs are additive with other efficiency technologies and, together identify the potential to reduce fuel consumption by 18 to 25 percent if deployed throughout the fleet, according to its 2018 research report, "Using Fuel Efficiency Regulations to Conserve Fuel and Save Lives by Accelerating Industry Investment in Autonomous and Connected Vehicles." In general, Securing America's Future Energy believes that CAVs can improve efficiency by lowering the amount of accidents, lowering congestion, and allowing for smarter navigation, amongst other benefits.

In response to Securing America's Future Energy's suggestion, NHTSA reiterates as mentioned in the 2012 final rule that our policy is to consider any fuel efficiency benefits for autonomous vehicles and advanced driver assistance systems (ADAS) as part of the regulatory process for its safety programs. At present, a number of these technologies are included in several Congressional bills that may mandate the adoption of new safety requirements or regulations in these areas. NHTSA will consider how to address the fuel efficiency benefits of these technologies as a part of its subsequent Congressional rulemakings.

B. Vehicle Classification and Compliance Validation Testing

Vehicle classification, for purposes of the light-duty CAFE program, refers to whether an automobile qualifies as a passenger automobile (car) or a non-passenger automobile (light truck). Passenger cars and light trucks are subject to different fuel economy standards as required by EPCA/EISA and consistent with their different capabilities.

Vehicles are designated as either passenger automobiles or non-passenger automobiles. Vehicles "capable of off-highway operation" are, by statute, non-passenger automobiles.¹²⁶⁵ Determining "off-highway operation" was left to NHTSA, and currently is a two-part inquiry: first, does the vehicle either have 4-wheel drive or over 6,000 pounds gross vehicle weight rating (GVWR), and second, does the vehicle have a significant feature designed for off-highway operation.¹²⁶⁶ NHTSA's regulation on vehicle classification contain requirements for vehicles to be classified as light trucks either on the basis of off-highway capability or on the basis of having "truck-like characteristics."¹²⁶⁷ Over time, NHTSA has refined the light truck vehicle classification by revising its regulations and issuing legal interpretations. However, based on the increase in crossover SUVs and advancements in vehicle design trends, NHTSA became aware of vehicle designs that complicate classification determinations for the CAFE program. Throughout the past decade, NHTSA identified these changes in compliance testing, data analysis, and has discussed the trend in rulemakings, publications, and with stakeholders.

In the SAFE 1 and SAFE 2 rules, NHTSA stated it continues to believe that an objective procedure for classifying vehicles is paramount to the agency's continued oversight of the CAFE program. When there is uncertainty as to how vehicles should be classified, inconsistency in determining manufacturers' compliance obligations can result, which is detrimental to the predictability and fairness of the program. In the 2020 final rule, NHTSA attempted to resolve several classification issues and committed to continuing research to resolve others. NHTSA notified the public of its plans to develop a compliance test procedure for verifying manufacturers' submitted classification data. An objective standard would help avoid manufacturers having to reclassify their vehicles, improve consistency and fairness across the industry, and introduce areas within the criteria where uncertainties existed, and research could be conducted in the near future to resolve.

In 2021 NPRM rulemaking,¹²⁶⁸ NHTSA provided additional classification, guidance and sought comments on several unknown aspects

¹²⁶³ Nissan, NHTSA–2021–0053–0022–A1, at p. 8; JLR, NHTSA–2021–0053–1505, at pp. 7–8; ITB Group, at NHTSA–2021–0053–0019–A1, at p. 3; Auto Innovators; Stellantis, NHTSA–2021–0053–1527, at p. 32; Toyota, NHTSA–2021–0053–1568, at p. 22.

¹²⁶⁴ Securing America's Future Energy, NHTSA–2021–0053–1513, at pp. 12–17.

¹²⁶⁵ 49 U.S.C. 32901(a)(18).

¹²⁶⁶ 49 CFR 523.5(b).

¹²⁶⁷ 49 CFR 523.5(a).

¹²⁶⁸ 86 FR 49602 (Sept. 3, 2021).

needed to develop its compliance test procedure. In this final rule, NHTSA is adding additional clarifications for testing production measurements for vehicles with adjustable suspensions and clarifying its intent to collect information from manufacturers for defining current axle and running clearance dimensions for light trucks. NHTSA is also clarifying a safety concern with its definition for classifying MPVs in 49 CFR 571.3 and its long-term plans to use requirements in its CAFE program to address the problem. In addition, NHTSA plans to release its draft test procedure later this year based upon the requirements finalized in this document. We note that we are not changing our current regulations on vehicle classification in this final rule.

1. Clarifications for Classifications Based Upon “Off-Road Capability”

For a vehicle to qualify as off-highway (off-road) capable, in addition to either having 4WD or a GVWR more than 6,000 pounds. The vehicle must have four out of five characteristics indicative of off-highway operation. These characteristics are:

- An approach angle of not less than 28 degrees
- A breakover angle of not less than 14 degrees
- A departure angle of not less than 20 degrees
- A running clearance of not less than 20 centimeters
- Front and rear axle clearances of not less than 18 centimeters each.

(a) Production Measurements

NHTSA’s regulations require manufacturers to measure vehicle characteristics when a vehicle is at its curb weight, on a level surface, with the front wheels parallel to the automobile’s longitudinal centerline, and the tires inflated to the manufacturer’s recommended cold inflation pressure.¹²⁶⁹ NHTSA clarified in the 2020 final rule that 49 CFR part 537 requires manufacturers to classify vehicles for CAFE based upon their physical production characteristics. The agency verifies reported values by measuring production vehicles. Manufacturers must also use physical vehicle measurements as the basis for values reported to the agency for purposes of vehicle classification. It may be possible for certain vehicles within a model type to qualify as light trucks while others would not because of their production differences. Since issuing the 2020 final rule, NHTSA has

met with manufacturers to reinforce the use of production measurements and to reduce reporting burdens to NHTSA. For example, NHTSA clarified that manufacturers should only report classification information for those physical measurements used for qualification and can omit other measurements.

In the previous rulemaking, NHTSA also identified that certain vehicle designs incorporated rigid (*i.e.*, inflexible) air dams, valance panels, exhaust pipes, and other components, equipped as manufacturers’ standard or optional equipment (*e.g.*, running boards and towing hitches), that likely violate a vehicles 20-centimeter running clearance. Despite these rigid features, some manufacturers were not taking these components into consideration when making classification decisions. Additionally, other manufacturers provided dimensions for their base vehicles without considering optional or various trim level components that may reduce the vehicle’s ground clearance. Consistent with our approach to other measurements, NHTSA clarifies that ground clearance, as well as all the other off-highway criteria for a light truck determination, should use the measurements from vehicles with all standard and optional equipment installed, at the time vehicles are shipped to dealerships. These views were shared by manufacturers in response to the previous CAFE rulemaking.

The agency reiterates that the characteristics listed in 49 CFR 523.5(b)(2) are characteristics indicative of off-highway capability. A fixed feature—such as an air dam that does not flex and return to its original state or an exhaust that could detach— inherently interferes with the off-highway capability of these vehicles. If manufacturers seek to classify vehicles as light trucks under 49 CFR 523.5(b)(2) and the vehicles have a production feature that does not meet the four remaining characteristics to demonstrate off-highway capability, they must be classified as passenger cars. NHTSA also clarifies that vehicles that have adjustable ride height, such as air suspension, and permit variable on-road or off-road running clearances should be classified based upon the mode most commonly used or the off-road mode for those with this feature. NHTSA sought comments in the NPRM on how to define the mode most commonly used for any adjustable suspensions. NHTSA also asked, in developing its planned test procedure expected later in MY 2022, would it be more appropriate to allow manufacturers to define the mode

setting for vehicles with adjustable suspensions.

In response to the NPRM, NHTSA received several comments about defining the mode most commonly used for any adjustable suspensions and, for the test procedure, whether it is more appropriate to allow manufacturers to define the mode setting for vehicles with adjustable suspensions. Comments were received from Auto Innovators,¹²⁷⁰ Stellantis,¹²⁷¹ JLR,¹²⁷² and Ford.¹²⁷³ In general, comments stated that manufacturers believe they should be able to define the setting for vehicles with adjustable suspension based on the manufacturer recommended setting for off-road use.

For example, Auto Innovators provided detailed comments explaining how that they believe manufacturers should be able to define the setting for vehicles with adjustable suspension based on the manufacturer recommended setting for off-road use.¹²⁷⁴ However, they also found through subsequent research and submitted to NHTSA that the most commonly used mode is not necessarily suited to off-road use given the relatively low frequency of such use. Auto Innovators stated that given the multitude of settings that a modern vehicle has, it should generally be the selection that provides the greatest ground clearance. Such settings are design features intended to further enable off-road operation. For vehicles with driver-selectable suspension settings, Auto Innovators recommends that the classification of off-road capabilities be determined on the dimensional characteristics using the highest ride height setting recommended for off-road use.

JLR agrees with Auto Innovators that an off-road mode, if available, should be used assessing the vehicle compliance to the off-road requirements.¹²⁷⁵ Further, if more than one off-road mode is available, the mode that achieves the highest ride height as this would be optimized for rock-crawling where the greatest ground clearance is needed. JLR believes that manufacturers should always define the mode used for determination of classification because one mode will be most suited to off-road use, and this would be highlighted to the owner. JLR states the most

¹²⁷⁰ Auto Innovators, NHTSA–2021–0053–1492, at page 66.

¹²⁷¹ Stellantis, NHTSA–2021–0053–1527, at page 29

¹²⁷² JLR, NHTSA–2021–0053–1505–A, at p. 5.

¹²⁷³ Ford, NHTSA–2021–0053–1545–A1, at p. 2.

¹²⁷⁴ Auto Innovators, NHTSA–2021–0053–1492, at page 66.

¹²⁷⁵ JLR, NHTSA–2021–0053–1505–A1, at p. 5.

¹²⁶⁹ 49 CFR 523.5(b)(2).

commonly used mode will not likely be the one to use for off-road, as most vehicles will be predominantly used on-road. It would be inappropriate to use a mode not intended for off-road use, simply because it was used most often. Stellantis agrees with Auto Innovators and JLR in relation to the suggestion that for the test procedure, it would be more appropriate to allow manufacturers to define the mode setting for vehicles with adjustable suspensions.

Ford supported NHTSA's proposal to conduct audits of vehicle measurements and vehicle classification.¹²⁷⁶ They state it is critical that vehicles are properly categorized to maintain the integrity of the CAFE program and to ensure a level playing field for all automobile manufacturers. Ford supports convening a group of expert stakeholders, including NHTSA and automobile manufacturers, to develop vehicle measurement processes and procedures in a future rulemaking. Ford recommended that manufacturers have the option to use Computer Aided Design (CAD) data for dimensional reporting. They stated the use of CAD data supports the timing and logistical requirements and allows all buildable combinations of vehicles, including optional equipment, to be assessed. Ford stated automobile manufacturers are ultimately responsible for ensuring that their vehicles are built according to their specifications and that all vehicles are properly categorized.

NHTSA agrees that auditing manufacturers' classification criteria will be necessary to create uniformity among vehicles classified as light trucks. NHTSA plans to use its upcoming compliance test procedure to collect more information on vehicles with adjustable suspensions. The questions in the 2021 NPRM attempted to clarify the correct height adjustment settings for of vehicles with adjustable suspension to determine if they meet the criteria in 49 CFR part 523 to be classified as light trucks. The agency thanks the industry for their feedback and will take it under advisement in future rulemakings and test procedures. While we are not changing our classification regulations in this rule, we want to note that we are still weighing whether it is appropriate to allow manufacturers to choose the height used to determine CAFE compliance for vehicles with adjustable suspensions. The purpose for our previous flexibility was to afford maximum leniency for vehicles necessary for off-road work purposes. However, given the vast

proliferation of SUVs and crossovers—the majority of which will never be used for off-road purposes—we believe that we will need to reevaluate what features are indicative of off-road purposes in the near future. Upon completion of NHTSA's CAFE vehicle classification testing program, the agency will send its annual compliance questions to manufacturers as a part of its normal compliance questionnaires to collect more information on all AWD/4WD vehicles with adjustable suspensions and to identify the available adjustable ride height settings of these vehicles. Furthermore, any vehicle tested will be required to specify all available off-road features as discussed above as information in response to NHTSA's testing specification request forms.¹²⁷⁷

The agency wants to remind manufacturers that a vehicle's CAFE classification is not dispositive of a vehicle's classification for our safety regulations. Vehicles classified as non-automobiles for CAFE may be considered passenger cars for our safety regulations.

Furthermore, consistent with our approach to other measurements, NHTSA is reaffirming for its final rule that manufacturers must measure ground clearances, as well as all the other off-highway criteria for a light truck determination, using vehicles with all standard and optional equipment installed, at the time vehicles are shipped to dealerships. These views were shared by manufacturers in response to the previous CAFE rulemaking. By using measurements from vehicles with all standard and optional equipment installed, at the time vehicles are shipped to dealerships, NHTSA can ensure that vehicles are properly classified.

Finally, NHTSA does not agree with Ford's recommendation that manufacturers should use Computer Aided Design (CAD) data for off-road dimensional reporting. CAD data have been shown in the past to be ineffective in providing accurate dimensions for production vehicles. Vehicles on dealer lots have shown high variance in terms of dimensions from region to region, across the country and in different markets. This is highly evident through numerous recalls under 49 CFR part 573 filed with NHTSA which identify variance in production plant as a cause for non-compliances or defects. In the vast majority of recalls, it shows that the population of vehicles affected are highly dependent on manufacturing

plant, equipment, and vehicle manufacturing processes. These variances mainly result from stack tolerances produced from a combination of manufacturing and production tolerances which are not fully accounted for in CAD drawings. Thus, CAD would not be a valid tool for representing vehicle production dimensions. However, NHTSA will continue to discuss the errors that may exist in using CAD for classifying vehicles with manufacturers for consideration in future rulemakings.

(b) Testing for Approach, Breakover, and Departure Angles

Approach angle, breakover angle, and departure angle are relevant to determine off-highway capability. Large approach and departure angles ensure the front and rear bumpers and valance panels have sufficient clearance for obstacle avoidance while driving off-road. The breakover angle ensures sufficient body clearance from rocks and other objects located between the front and rear wheels while traversing rough terrain. Both the approach and departure angles are derived from a line tangent to the front (or rear) tire static loaded radius arc extending from the ground near the center of the tire patch to the lowest contact point on the front or rear of the vehicle. The term "static loaded radius arc" is based upon the definitions in SAE J1100 and J1544.¹²⁷⁸ The term is defined as the distance from wheel axis of rotation to the supporting surface (ground) at a given load of the vehicle and stated inflation pressure of the tire (manufacturer's recommended cold inflation pressure).

The static loaded radius arc is easy to measure for computer simulations, but the imaginary line tangent to the static loaded radius arc is difficult to ascertain in the field. The approach and departure angles are the angles between the line tangent to the static loaded radius arc and the level ground on which the test vehicle rests. For the compliance test procedure, a substitute measurement will be used. A measurement that provides a good approximation of the approach and departure angles involve using a line tangent to the outside diameter or perimeter of the tire and extends to the lowest contact point on the front or rear of the vehicle. This approach provides an angle slightly greater than the angle derived from the true static loaded radius arc. The approach also has the advantage to allow measurements to be made quickly for measuring angles in the field to

¹²⁷⁷ See <https://www.nhtsa.gov/vehicle-manufacturers/test-specification-forms>. (Accessed: March 15, 2022)

¹²⁷⁸ See SAE J1100 published on May 26, 2012 and SAE J1544 published on Oct 25, 2011.

¹²⁷⁶ Ford, NHTSA–2021–0053–1545–A1, at p. 2.

verify data submitted by the manufacturers used to determine light truck classification decisions. In order to comply, the vehicle measurement must be equal to or greater than the required measurements to be considered as compliant and if not, the reported value will require an investigation which could lead to the manufacturer's vehicle becoming reclassified as a passenger car.

NHTSA plans to start developmental testing for its test vehicle classification test procedures. We agree with Ford that opening discussions with expert stakeholders, including NHTSA and automobile manufacturers, to develop vehicle measurement processes and procedures is a worthy goal especially during our fabrication of a device to measure approach, breakover and departure angles. We reiterate that manufacturers should determine their vehicle classifications using off-road angles based on a line tangent to the front (or rear) tire static loaded radius arc. However, for developmental testing, NHTSA will evaluate the differences in angle measurements between those using its substitute approach (a line tangent to the outside diameter or perimeter of the tire and extends to the lowest contact point on the front or rear of the vehicle) and the true angle based on the static loaded radius arc. We will share the results with manufacturers to establish the variations in the measurements and to identify any complications. Depending upon the outcome of comparisons and developments for a suitable test device using the static loaded radius arc, a simple and repeatable apparatus, the agency may forgo establishing a device for its alternative angle measurement approach for compliance testing. NHTSA will start reaching out to interested parties in the next couple of months to start researching approaches for developing test devices.

(c) Running Clearance

NHTSA regulations define "running clearance" as "the distance from the surface on which an automobile is standing to the lowest point on the automobile, excluding unsprung weight."¹²⁷⁹ Unsprung weight includes the components (e.g., suspension, wheels, axles, and other components directly connected to the wheels and axles) that are connected and translate with the wheels. Sprung weight, on the other hand, includes all components fixed underneath the vehicle that translate with the vehicle body (e.g., mufflers and subframes). To clarify

these requirements, NHTSA previously issued a letter of interpretation stating that certain parts of a vehicle—such as tire aero deflectors that are made of flexible plastic, bend without breaking, and return to their original position—would not count against the 20-centimeter running clearance requirement.¹²⁸⁰ The agency explained that this does not mean a vehicle with less than 20 centimeters running clearance could be elevated by an upward force that bends the deflectors and still be considered compliant with the running clearance criterion, as it would be inconsistent with the conditions listed in the introductory paragraph of 49 CFR 523.5(b)(2). Further, NHTSA explained that without a flexible component installed, the vehicle must meet the 20-centimeter running clearance requirement along its entire underside. This 20-centimeter clearance is required for all sprung weight components. For its compliance test procedure, NHTSA will include a list of the all the components under the vehicle considered as unsprung components. NHTSA will update the list of unsprung components as the need arises.

NHTSA received several comments in relation to defining "running clearance" as per regulations. Comments were received from Stellantis¹²⁸¹ and Hyundai.¹²⁸² Stellantis provided comments stating they agree that the 20 cm clearance is for all sprung components. They also appreciate the agency re-affirming its interpretation that flexible components that return to their original position without breaking are not to be included in the assessment. Hyundai provided comments requesting NHTSA to clarify that vehicles classified for off-road use according to the physical production characteristic of ground clearance should meet a minimum value whereby higher values are acceptable. Hyundai stated NHTSA provides requirements for a variety of criteria where a minimum or maximum value is appropriate. They state, for example, "NHTSA regulations state that front and rear axle clearances of not less than 18 centimeters are another criterion that can be used for designating a vehicle as off-highway capable". Hyundai continued "NHTSA explained that without a flexible component installed, the vehicle must meet the 20-centimeter running

clearance requirement along its entire underside".

NHTSA agrees with Stellantis that the 20 cm clearance requirement is for sprung components as per NHTSA's regulations and prior interpretations.

In response to Hyundai, NHTSA reiterates that the 20-centimeter clearance is required for all sprung weight components. This is not related to unsprung weight components such as axles. Unsprung weight includes the components (e.g., suspension, wheels, axles, and other components directly connected to the wheels and axles) that are connected and translate with the wheels. Sprung weight, on the other hand, includes all components fixed underneath the vehicle that translate with the vehicle body (e.g., mufflers and subframes). For its compliance test procedure, NHTSA will include a list of the all the components under the vehicle considered as unsprung components. NHTSA will update the list of unsprung components as the need arises.

(d) Front and Rear Axle Clearance

NHTSA regulations state that front and rear axle clearances of not less than 18 centimeters are another criterion that can be used for designating a vehicle as off-highway capable.¹²⁸³ The agency defines "axle clearance" as the vertical distance from the level surface on which an automobile is standing to the lowest point on the axle differential of the automobile.

The agency believes this definition may be outdated because of vehicle design changes, including axle system components and independent front and rear suspension components which hang lower than the differential. In the past, traditional light trucks with 4WD systems had solid rear axles with center-mounted differential on the axle. For these trucks, the rear axle differential was closer to the ground than any other axle or suspension system components. This traditional axle design still exists today for some trucks with a solid chassis (also known as body-on-frame configuration). Today, however, many SUVs and CUVs that qualify as light trucks are constructed with a unibody frame and have unsprung (e.g., control arms, tie rods, ball joints, struts, shocks, etc.) and sprung components (e.g., the axle subframes) connected together as a part of the axle assembly. These unsprung and sprung components are located under the axles, making them lower to the ground than the axles and the differential, and were not contemplated when NHTSA established

¹²⁸⁰ See <https://www.nhtsa.gov/interpretations/11-000612-medie-part-523> (accessed Mar. 29, 2022).

¹²⁸¹ Stellantis, NHTSA-2021-0053-1527, at page 29.

¹²⁸² Hyundai, NHTSA-2021-0053-1512-A1, at page 8.

¹²⁸³ 49 CFR 523.5(b)(2).

¹²⁷⁹ 49 CFR 523.2.

the definition and the allowable clearance for axles. The definition also did not originally account for 2WD vehicles with GVWRs greater than 6,000 pounds that had one axle without a differential, such as the model year 2018 Ford Expedition. Vehicles with axle components that are low enough to interfere with the vehicle's ability to perform off-road would seem inconsistent with the regulation's intent of ensuring off-highway capability.

In light of these issues, for the compliance test procedure, in the 2020 final rule, NHTSA stated it would request manufacturers to identify those axle components that are sprung or unsprung and provide sufficient justification as a part of the testing setup request forms sent to manufacturers in support of its compliance testing program. In addition, for vehicles without a differential, NHTSA would request the location each manufacturer used to establish its axle clearance qualification. NHTSA would validate the location specified by the manufacturer but would challenge any location on the vehicle's axle found to be located at a lower elevation to the ground than the designed location of its axle clearance measurement. NHTSA reiterated this approach in the 2021 NPRM and committed to adding the approach in its upcoming vehicle classification test procedure.¹²⁸⁴

In response to the NPRM, NHTSA received several comments in relation to defining "Front and Rear Axle Clearance" as per NHTSA regulations. Comments were received from Auto Innovators¹²⁸⁵ and Stellantis.¹²⁸⁶ Auto Innovators provided comments stating they believe the current definition is sufficient as the differential is the vulnerable component. They expressed that other suspension components closer to the tire are not likely to: (1) Hit the ground due to proximity to the tire, and (2) are much more likely to tolerate the occasional contact in a 4-low/off-road situation. Auto Innovators stated if NHTSA believes addressing suspension or axle components in independent suspension systems is necessary, it should engage with SAE International to develop a procedure for measuring the clearances of such components, determine typical clearances in vehicles classified as light trucks based on other off-road capability criteria, and seek input from automobile manufacturers and off-road user groups. Auto

Innovators believed only then should NHTSA consider formally proposing appropriate additional off-road characteristics for 49 CFR 523.5(b)(2) to address such components. They stated if NHTSA modified the definition of "axle clearance" or changes its interpretation of the definition, through test procedures or otherwise, to include components or locations other than the bottom of the differential, it should not reclassify vehicles on the basis of such changes until MY 2027 at the earliest, and the footprint-based target curves should be reassessed.

Additionally, Stellantis provided comments stating suspension components, both on a solid axle truck or independent suspension have the possibility of being closer to the ground, but this is generally closer to the tire where the ground clearance need is least as the tire will lift the vehicle and nearby suspension components over an obstacle, versus a differential that might make contact if a driver chooses to straddle an obstacle.¹²⁸⁷ Further, they believe, suspension components are unlikely to be damaged by light or incidental contact and therefore don't need the same clearance protection as a differential. Lastly, they believe, the suspension components essentially prevent ground contact to half shafts so they are similarly not vulnerable to contact. Stellantis does not believe a change is needed to the axle clearance requirement. If a change is needed, Stellantis requested that the agency work with manufacturers to develop a new requirement. They stated regardless, any change to this requirement demands ample lead-time for manufacturers to incorporate into a redesign. They believe anything less would result in a de facto stringency change in the rule as some number of vehicles would presumably be reclassified as passenger cars. Stellantis stated this has not been considered and is not likely to be trivial. Stellantis believed if this change is adopted, then the agency should also work with industry to understand which vehicles would become part of the passenger car fleet, and then reassess the footprint stringency lines for both fleets.

We thank the industry for their input, and will take it into consideration as we consider CAFE vehicle classifications in the future. The comments raised further questions. Our regulations state that front and rear axle clearances of not less than 18 centimeters are another criterion that can be used for designating a vehicle as off-highway

capable. Vehicles with axle components that are low enough to interfere with the vehicle's ability to perform off-road would seem inconsistent with the regulation's intent of ensuring off-highway capability. Both Auto Innovators and Stellantis assume that suspension components closer to the tire are not likely to: (1) Hit the ground due to proximity to the tire, and (2) are much more likely to tolerate the occasional contact in an off-road situation. However, we are uncertain if commenters considered the possibility of debris or obstacles encountered off-road that could significantly damage these components. While differentials are significant components of an off-road vehicles ability to traverse off-road terrains so are other suspension components and any ridged components attached to the vehicle that are lower than the differential. There are a multitude of scenarios where these unsprung and sprung components could be damaged significantly decreasing the off-road ability of a vehicle. We need to assess these factors as the agency works with manufacturers to develop a new requirement as Auto Innovators and Stellantis suggested. NHTSA's current intent presently is not to modify the definition of "axle clearance" or adopt changes through its test procedure but rather to continue collecting information through communication with the industry and then in subsequent rulemaking consider changes to its definitions. NHTSA also agrees with Auto Innovators and Stellantis that the agency should also work with industry to understand which vehicles would become part of the passenger car fleet and reassess the footprint stringency lines for both fleets.

(e) 49 CFR 571.3 MPV Definition

As discussed in the previous sections, NHTSA asked commenters to provide some feedback to assist in the creation of test procedures. While "multi-purpose vehicles" (MPVs) is not a vehicle classification for CAFE purposes, we took the opportunity to seek comment on our definition of MPV in the proposal as it touches upon many of the same issues discussed above. In the proposal, NHTSA questioned whether to link the definition of MPV in 49 CFR 571.3 (as it relates to special features for occasional off-road operation) to 49 CFR 523.5(b)(2). It also asked what drawbacks exist in linking both provisions. Another question raised was whether using the longstanding off-road features for fuel economy provides could clarify the means for certifying that a vehicle meets the definition for MPV in § 571.3 when

¹²⁸⁴ 86 FR 49602 (Sept. 3, 2021).

¹²⁸⁵ Auto Innovators, NHTSA-2021-0053-1492, at page 69.

¹²⁸⁶ Stellantis, NHTSA-2021-0053-1527, at page 29.

¹²⁸⁷ Stellantis, NHTSA-2021-0053-1527, at page 29.

manufacturers may otherwise be uncertain as to how to classify a vehicle.

In response to the NPRM, NHTSA received several comments in relation to linking the definition of MPV in 49 CFR 571.3, as it relates to special features for occasional off-road operation, to the one in 49 CFR 523.5(b)(2). Comments were received from Auto Innovators,¹²⁸⁸ Ford,¹²⁸⁹ Hyundai,¹²⁹⁰ and JLR.¹²⁹¹ In general, comments opposed linking the two standards, but failed to define other special features to qualify for occasional off-road operation. We will use the feedback from manufacturers in the future when we consider safety vehicle classification.

VIII. Regulatory Notices and Analyses

A. Executive Order 12866, Executive Order 13563

Executive Order 12866, “Regulatory Planning and Review” (58 FR 51735, Oct. 4, 1993), as amended by Executive Order 13563, “Improving Regulation and Regulatory Review” (76 FR 3821, Jan. 21, 2011), provides for making determinations whether a regulatory action is “significant” and therefore subject to the Office of Management and Budget (OMB) review process and to the requirements of the Executive order. Under these Executive orders, this action is an “economically significant regulatory action” because it is likely to have an annual effect on the economy of \$100 million or more. Accordingly, NHTSA submitted this action to OMB for review and any changes made in response to OMB recommendations have been documented in the docket for this action. The benefits and costs of this final rule are described above and in the FRIA, which is located in the docket and on NHTSA’s website.

B. DOT Regulatory Policies and Procedures

This final rule is also significant within the meaning of the Department of Transportation’s Regulatory Policies and Procedures. The benefits and costs of the final rule are described above and in the FRIA, which is located in the docket and on NHTSA’s website.

C. Executive Order 13990

Executive Order 13990, “Protecting Public Health and the Environment and Restoring Science to Tackle the Climate Crisis” (86 FR 7037, Jan. 25, 2021), directed the immediate review of “The

¹²⁸⁸ Auto Innovators, NHTSA–2021–0053–1492, at pp. 70–71.

¹²⁸⁹ Ford, NHTSA–2021–0053–1545–A1, at p. 2.

¹²⁹⁰ Hyundai, NHTSA–2021–0053–1512–A1, at p. 8.

¹²⁹¹ JLR, NHTSA–2021–0053–1505–A, at p. 1.

Safer Affordable Fuel-Efficient (SAFE) Vehicles Rule for Model Years 2021–2026 Passenger Cars and Light Trucks” (the 2020 final rule) by July 2021. The Executive order directed that “[i]n considering whether to propose suspending, revising, or rescinding that rule, the agency [*i.e.*, NHTSA] should consider the views of representatives from labor unions, States, and industry.”

This final rule follows the review directed in this Executive order. Promulgated under NHTSA’s statutory authorities, it finalizes new CAFE standards for the model years covered by the 2020 final rule for which there is still available lead time to change, and it accounts for the views provided by labor unions, States, and industry.

D. Environmental Considerations

1. National Environmental Policy Act (NEPA)

Concurrently with this final rule, the agency is releasing a Final SEIS, pursuant to the National Environmental Policy Act, 42 U.S.C. 4321 through 4347, and implementing regulations issued by the Council on Environmental Quality (CEQ), 40 CFR part 1500, and NHTSA, 49 CFR part 520. The agency prepared the Final SEIS to analyze and disclose the potential environmental impacts of the proposed CAFE standards and a range of alternatives. The Final SEIS analyzes direct, indirect, and cumulative impacts and analyzes impacts in proportion to their significance. It describes potential environmental impacts to a variety of resources, including fuel and energy use, air quality, climate, land use and development, hazardous materials and regulated wastes, historical and cultural resources, noise, and environmental justice. The Final SEIS also describes how climate change resulting from global carbon dioxide emissions (including CO₂ emissions attributable to the U.S. light duty transportation sector under the alternatives considered) could affect certain key natural and human resources. Resource areas are assessed qualitatively and quantitatively, as appropriate, in the Final SEIS.

The agency has considered the information contained in the Final SEIS in making the final decision described in this final rule.¹²⁹² This preamble and final rule constitute the agency’s Record of Decision (ROD) under 40 CFR 1505.2 for its promulgation of CAFE standards for MYs 2024–2026. The agency has authority to issue its Final SEIS and

¹²⁹² The Final SEIS is available for review in the public docket for this action and in Docket No. NHTSA–2021–0054.

ROD simultaneously pursuant to 49 U.S.C. 304a(b) and U.S. Department of Transportation, Office of Transportation Policy, *Guidance on the Use of Combined Final Environmental Impact Statements/Records of Decision and Errata Sheets in National Environmental Policy Act Reviews* (April 25, 2019).¹²⁹³ NHTSA has determined that neither the statutory criteria nor practicability considerations preclude simultaneous issuance.

As required by the CEQ regulations,¹²⁹⁴ this final rule (as the ROD) sets forth the following in Sections IV, V, and VI above (1) the agency’s decision (2) alternatives considered by NHTSA in reaching its decision, including the environmentally preferable alternative; (3) the factors balanced by NHTSA in making its decision, including essential considerations of national policy (Section VIII.B above); (4) how these factors and considerations entered into its decision; and (5) the agency’s preferences among alternatives based on relevant factors, including economic and technical considerations and agency statutory missions. The following sections discuss comments received on the Draft SEIS, NHTSA’s range of alternatives, and other factors used in the decision-making process. This section also briefly addresses mitigation¹²⁹⁵ and whether all practicable means to avoid or minimize environmental harm from the alternative selected have been adopted.

One commenter, the WDNR, stated that NHTSA should collaborate more with EPA, especially when it comes to addressing any collateral impacts on criteria pollutant emissions, since both agencies have rulemakings related to analyses of anticipated GHG and criteria pollutant emissions impacts. NHTSA believes that it properly coordinates with EPA and that differences in the respective rules are due to each agencies’ authority. EPA is a Cooperating Agency on the Final SEIS, and as such, NHTSA coordinated with EPA to review and comment on the Draft and Final SEISs prior to publication. Separately, as discussed further below and in the Final SEIS, the agency’s authority to promulgate fuel economy standards does not allow it to regulate criteria pollutants from vehicles

¹²⁹³ The guidance is available at <https://www.transportation.gov/sites/dot.gov/files/docs/mission/transportation-policy/permittingcenter/337371/feis-rod-guidance-final-04302019.pdf> (accessed: February 10, 2022).

¹²⁹⁴ 40 CFR 1505.2.

¹²⁹⁵ See 40 CFR 1508.1(s) (“Mitigation includes . . . [m]inimizing impacts by limiting the degree or magnitude of the action and its implementation.”).

or refineries (nor can NHTSA regulate other factors affecting those emissions, such as driving habits); however, EPA still retains the ability to regulate NAAQS under the Clean Air Act.

Some commenters agreed that that the range of alternatives presented in NHTSA's Proposal and accompanying Draft SEIS represented a reasonable range of final agency actions. However, some commenters advocated for the finalization of standards more stringent than Alternative 2 to better advance NHTSA's statutory purposes of maximizing fuel economy considering the environmental, health, and security needs of the United States to conserve energy. Some commenters stated that NHTSA needs to implement more stringent standards in order to improve public health, to help mitigate some of the impacts of climate change, including poor air quality, to assist States in attaining and maintaining the National Ambient Air Quality Standards (NAAQS), and to meet environmental justice goals. NHTSA agrees that increasing the fuel economy of the passenger car and light-truck fleet would result in public health and climate benefits, which are analyzed in the Final SEIS, the TSD, and the FRIA.

As described in the Final SEIS, Chapter 1, *Purpose and Need for the Action*, NHTSA must consider the requirements of EPCA, which sets forth the four factors the agency must balance when determining "maximum feasible" standards. NHTSA's explanation for how it arrived at the range of alternatives under consideration is in Section IV and VI and incorporated by reference in the SEIS. NHTSA must consider *all* the statutory factors when considering which standards are maximum feasible, and cannot consider some to the exclusion of others, as described at length in Section VI of this preamble. NHTSA agrees with commenters that the range of alternatives under consideration in the SEIS is reasonable, in light of the factors it must balance. All of the action alternatives NHTSA evaluated for the SEIS would result in substantial fuel savings and associated GHG emissions reductions, as well as many of the other benefits highlighted by the commenters. NHTSA also believes that considering more aggressive standards beyond what the agency has modeled for the action alternatives would exceed maximum feasibility.

In the Draft SEIS and in the Final SEIS, the agency identified a Preferred Alternative. In the Draft SEIS, the Preferred Alternative was identified as Alternative 2 (8.0 percent average annual increase for both passenger cars

and light trucks for MYs 2024–2026), which were the standards the agency proposed in the NPRM. In the Final SEIS, the Preferred Alternative was identified as Alternative 2.5. As the Final SEIS notes, under the Preferred Alternative, on an mpg basis, the estimated annual increases in the average required fuel economy levels between MYs 2024 and 2025 is 8.0 percent for both passenger cars and light trucks and for MY 2026, annual increases in average require fuel economy levels is 10.0 percent for both passenger cars and light trucks.¹²⁹⁶ After carefully reviewing and analyzing all of the information in the public record, comments submitted on the Draft SEIS, and the Final SEIS, NHTSA decided to finalize the Preferred Alternative described in the Final SEIS for the reasons described in this ROD.

Some commenters agreed with the underlying CAFE Model assumptions that affected the environmental modeling in the SEIS, like including the California's ZEV standards in the baseline for this final rule. Other commenters disagreed with some assumptions, such as rebound rate and import share assumptions, and identified the impact of those assumptions on VMT. Another commenter noted that NHTSA used outdated CAFE Model input assumptions that inform the analyses presented in the SEIS and do not reflect the best available evidence. The agency addresses the comments regarding the CAFE Model above in Section III of the preamble. NHTSA has considered and accounted for California's ZEV standards in developing the baseline for this final rule and agrees that it is reasonable to include these standards in the baseline for this final rule as they are other legal requirements affecting automakers. To the extent that commenters are concerned about CAFE Model input assumptions that inform the analyses presented in the Draft and Final SEIS, as discussed further in preamble Section II.C, *Changes in Light of Public Comments and New Information*, NHTSA did update the analysis for the final rule. Some of these updates include updates to assumptions mentioned by the commenter, *e.g.*, adjusting the measure of rebound

¹²⁹⁶ Because the standards are attribute-based, average required fuel economy levels, and therefore rates of increase in those average mpg values, depend on the future composition of the fleet, which is uncertain and subject to change. When NHTSA describes a percent increase in stringency, we mean in terms of shifts in the *footprint functions* that form the basis for the *actual* CAFE standards (as in, on a gallon per mile basis, the CAFE standards change by a given percentage from one model year to the next).

driving from fifteen to ten percent. A full list of changes for the final rule analysis and the basis for those changes is discussed throughout the preamble and in the relevant portions of the TSD.

NHTSA performed a national-scale photochemical air quality modeling and health benefit assessment for the Final SEIS; it is included as Appendix D. The purpose of this assessment was to use air quality modeling and health-related benefits analysis tools to examine the potential air quality-related consequences of the alternatives considered in the Draft SEIS. As provided for prior rulemakings and for the scoping notice for this EIS, NHTSA also announced that, due to the substantial lead time required, the analysis would be based on the modeling of the alternatives presented in the Draft SEIS, not of the alternatives as presented in the Final SEIS. Furthermore, while photochemical modeling provides spatial and temporal detail for estimating changes in ambient levels of air pollutants and their associated impacts on human health and welfare for the alternatives considered, the analysis affirms the estimates that appear in the SEIS and does not provide significant new information for the decisionmaker or the public.

The Sierra Club stated that NHTSA's Draft SEIS presents "an erroneous picture of the GHG emissions impacts of battery electric vehicles (EVs)" and relies on "stale data."¹²⁹⁷ The commenter stated that "when more current data are used, the results are dramatically different and show that EVs are already superior to internal combustion engine (ICE) vehicles from a GHG emissions perspective across almost the entire country, and trends in power generation will cause EVs to further outpace ICE vehicles on emission reductions in the coming years." NHTSA has updated the Final SEIS Section 6.2.3.1, *Charging Locations*, to use more appropriate and current emission factors to assess the CO₂ impacts from electric vehicle (EV) charging locations and behaviors, and NHTSA updated Section 6.2.1, *Diesel and Gasoline*, in the Final SEIS to discuss transporting oil sands crude by pipeline and rail.

NHTSA considered environmental considerations as part of its balancing of

¹²⁹⁷ NHTSA acknowledged but did not address this limitation in the Draft SEIS. Draft SEIS at 6–16 ("The U.S. grid mix has changed significantly over the past decade, and this means that older [life-cycle assessments] based on different grid mix assumptions might not be comparable with findings in Chapters 4 and 5, which are based on more recent grid mix forecasts.").

the statutory factors to set maximum feasible fuel economy standards. As a result, the agency has limited the degree or magnitude of the action as appropriate in light of its statutory responsibilities. The agency's authority to promulgate fuel economy standards does not allow it to regulate criteria pollutants from vehicles or refineries, nor can NHTSA regulate other factors affecting those emissions, such as driving habits. Consequently, NHTSA must set CAFE standards but is unable to take further steps to mitigate the impacts of these standards. Chapter 9 of the Final SEIS provides a further discussion of mitigation measures in the context of NEPA.

2. Clean Air Act (CAA) as Applied to NHTSA's Final Rule

The CAA (42 U.S.C. 7401 *et seq.*) is the primary Federal legislation that addresses air quality. Under the authority of the CAA and subsequent amendments, EPA has established National Ambient Air Quality Standards (NAAQS) for six criteria pollutants, which are relatively commonplace pollutants that can accumulate in the atmosphere as a result of human activity. EPA is required to review each NAAQS every five years and to revise those standards as may be appropriate considering new scientific information.

The air quality of a geographic region is usually assessed by comparing the levels of criteria air pollutants found in the ambient air to the levels established by the NAAQS (taking into account, as well, the other elements of a NAAQS: Averaging time, form, and indicator). Concentrations of criteria pollutants within the air mass of a region are measured in parts of a pollutant per million parts (ppm) of air or in micrograms of a pollutant per cubic meter ($\mu\text{g}/\text{m}^3$) of air present in repeated air samples taken at designated monitoring locations using specified types of monitors. These ambient concentrations of each criteria pollutant are compared to the levels, averaging time, and form specified by the NAAQS in order to assess whether the region's air quality is in attainment with the NAAQS.

When the measured concentrations of a criteria pollutant within a geographic region are below those permitted by the NAAQS, EPA designates the region as an attainment area for that pollutant, while regions where concentrations of criteria pollutants exceed Federal standards are called nonattainment areas. Former nonattainment areas that are now in compliance with the NAAQS are designated as maintenance areas. Each State with a nonattainment area is

required to develop and implement a State Implementation Plan (SIP) documenting how the region will reach attainment levels within time periods specified in the CAA. For maintenance areas, the SIP must document how the State intends to maintain compliance with the NAAQS. When EPA revises a NAAQS, each State must revise its SIP to address how it plans to attain the new standard.

No Federal agency may "engage in, support in any way or provide financial assistance for, license or permit, or approve" any activity that does not "conform" to a SIP or Federal Implementation Plan after EPA has approved or promulgated it.¹²⁹⁸ Further, no Federal agency may "approve, accept, or fund" any transportation plan, program, or project developed pursuant to title 23 or chapter 53 of title 49, U.S.C., unless the plan, program, or project has been found to "conform" to any applicable implementation plan in effect.¹²⁹⁹ The purpose of these conformity requirements is to ensure that Federally sponsored or conducted activities do not interfere with meeting the emissions targets in SIPs, do not cause or contribute to new violations of the NAAQS, and do not impede the ability of a State to attain or maintain the NAAQS or delay any interim milestones. EPA has issued two sets of regulations to implement the conformity requirements:

(1) The Transportation Conformity Rule¹³⁰⁰ applies to transportation plans, programs, and projects that are developed, funded, or approved under title 23 or chapter 53 of title 49, U.S.C.

(2) The General Conformity Rule¹³⁰¹ applies to all other Federal actions not covered under transportation conformity. The General Conformity Rule establishes emissions thresholds, or *de minimis* levels, for use in evaluating the conformity of an action that results in emissions increases.¹³⁰² If the net increases of direct and indirect emissions exceed any of these thresholds, and the action is not otherwise exempt, then a conformity determination is required. The conformity determination can entail air quality modeling studies, consultation with EPA and state air quality agencies, and commitments to revise the SIP or to implement measures to mitigate air quality impacts.

¹²⁹⁸ 42 U.S.C. 7506(c)(1).

¹²⁹⁹ 42 U.S.C. 7506(c)(2).

¹³⁰⁰ 40 CFR part 51, subpart T, and part 93, subpart A.

¹³⁰¹ 40 CFR part 51, subpart W, and part 93, subpart B.

¹³⁰² 40 CFR 93.153(b).

The CAFE standards and associated program activities are not developed, funded, or approved under title 23 or chapter 53 of title 49, United States Code. Accordingly, this action and associated program activities are not subject to transportation conformity. Under the General Conformity Rule, a conformity determination is required where a Federal action would result in total direct and indirect emissions of a criteria pollutant or precursor originating in nonattainment or maintenance areas equaling or exceeding the rates specified in 40 CFR 93.153(b)(1) and (2). As explained below, the agency's action results in neither direct nor indirect emissions as defined in 40 CFR 93.152.

The General Conformity Rule defines direct emissions as "those emissions of a criteria pollutant or its precursors that are caused or initiated by the Federal action and originate in a nonattainment or maintenance area and occur at the same time and place as the action and are reasonably foreseeable."¹³⁰³ The agency's action would set fuel economy standards for light duty vehicles. It therefore would not cause or initiate direct emissions consistent with the meaning of the General Conformity Rule.¹³⁰⁴ Indeed, the agency's action in aggregate reduces emissions, and to the degree the model predicts small (and time-limited) increases, these increases are based on a theoretical response by individuals to fuel economy prices and savings, which are at best indirect. Indirect emissions under the General Conformity Rule are those emissions of a criteria pollutant or its precursors (1) that are caused or initiated by the Federal action and originate in the same nonattainment or maintenance area but occur at a different time or place as the action; (2) that are reasonably foreseeable; (3) that the agency can practically control; and (4) for which the agency has continuing program responsibility.¹³⁰⁵ Each element of the definition must be met to qualify as indirect emissions. NHTSA has determined that, for purposes of general conformity, emissions (if any) that may result from its final fuel economy standards would not be caused by the agency's action, but rather would occur because of subsequent activities the

¹³⁰³ 40 CFR 93.152.

¹³⁰⁴ *Dep't of Transp. v. Pub. Citizen*, 541 U.S. at 772 ("[T]he emissions from the Mexican trucks are not 'direct' because they will not occur at the same time or at the same place as the promulgation of the regulations."). NHTSA's action is to establish fuel economy standards for MY 2021–2026 passenger car and light trucks; any emissions increases would occur in a different place and well after promulgation of the final rule.

¹³⁰⁵ 40 CFR 93.152.

agency cannot practically control. “[E]ven if a Federal licensing, rulemaking or other approving action is a required initial step for a subsequent activity that causes emissions, such initial steps do not mean that a Federal agency can practically control any resulting emissions.”¹³⁰⁶

As the CAFE program uses performance-based standards, NHTSA cannot control the technologies vehicle manufacturers use to improve the fuel economy of passenger cars and light trucks. Furthermore, NHTSA cannot control consumer purchasing (which affects average achieved fleetwide fuel economy) and driving behavior (*i.e.*, operation of motor vehicles, as measured by VMT). It is the combination of fuel economy technologies, consumer purchasing, and driving behavior that results in criteria pollutant or precursor emissions. For purposes of analyzing the environmental impacts of the alternatives considered under NEPA, NHTSA has made assumptions regarding all of these factors. The agency’s Final SEIS projects that increases in air toxic and criteria pollutants would occur in some nonattainment areas under certain alternatives in the near term, although over the longer term, all action alternatives see improvements. However, the standards and alternatives do not mandate specific manufacturer decisions, consumer purchasing, or driver behavior, and NHTSA cannot practically control any of them.¹³⁰⁷

One commenter, the WDNR, stated that “NHTSA should work with EPA to offset any short-term increases in NO_x and VOC emissions associated with the rule” and suggested that NHTSA is “largely plac[ing] the burden of implementing any measures on state and local agencies” by not taking certain actions to offset criteria pollutant increases. NHTSA disagrees, as it is not within NHTSA’s jurisdiction to implement such measures and lacks the expertise to conduct a full-scale analysis of their efficacy.

In addition, NHTSA does not have the statutory authority to control the actual VMT by drivers. As the extent of emissions is directly dependent on the operation of motor vehicles, changes in any emissions that result from the agency’s CAFE standards are not changes the agency can practically control or for which the agency has

continuing program responsibility. Therefore, the final CAFE standards and alternative standards considered by NHTSA would not cause indirect emissions under the General Conformity Rule, and a general conformity determination is not required.

3. National Historic Preservation Act (NHPA)

The NHPA (54 U.S.C. 300101 *et seq.*) sets forth Government policy and procedures regarding “historic properties”—that is, districts, sites, buildings, structures, and objects included on or eligible for the National Register of Historic Places. Section 106 of the NHPA requires Federal agencies to “take into account” the effects of their actions on historic properties.¹³⁰⁸ The agency concludes that the NHPA is not applicable to this rulemaking because the promulgation of CAFE standards for light duty vehicles is not the type of activity that has the potential to cause effects on historic properties. However, NHTSA includes a brief, qualitative discussion of the impacts of the alternatives on historical and cultural resources in the Final SEIS.

4. Fish and Wildlife Conservation Act (FWCA)

The FWCA (16 U.S.C. 2901 *et seq.*) provides financial and technical assistance to States for the development, revision, and implementation of conservation plans and programs for nongame fish and wildlife. In addition, the Act encourages all Federal departments and agencies to utilize their statutory and administrative authorities to conserve and to promote conservation of nongame fish and wildlife and their habitats. The agency concludes that the FWCA does not apply to this final rule because it does not involve the conservation of nongame fish and wildlife and their habitats. However, NHTSA conducted a qualitative review in its Final SEIS of the related direct, indirect, and cumulative impacts, positive or negative, of the alternatives on potentially affected resources, including nongame fish and wildlife and their habitats.

5. Coastal Zone Management Act (CZMA)

The Coastal Zone Management Act (16 U.S.C. 1451 *et seq.*) provides for the preservation, protection, development, and (where possible) restoration and enhancement of the Nation’s coastal

zone resources. Under the statute, States are provided with funds and technical assistance in developing coastal zone management programs. Each participating State must submit its program to the Secretary of Commerce for approval. Once the program has been approved, any activity of a Federal agency, either within or outside of the coastal zone, that affects any land or water use or natural resource of the coastal zone must be carried out in a manner that is consistent, to the maximum extent practicable, with the enforceable policies of the State’s program.¹³⁰⁹

NHTSA concludes that the CZMA does not apply to this rulemaking because it does not involve an activity within, or outside of, the Nation’s coastal zones that affects any land or water use or natural resource of the coastal zone.

The Center for Biological Diversity (CBD) commented that sea-level rise driven by climate change is accelerating and threatening many coastal species, including citing research results “that sea level rise resulting from climate change, and the inadequacy of existing regulatory mechanisms to address climate change, are primary threats endangering these species,” including the loggerhead turtle, and that “sea level rise will be much more extreme without strong action to reduce greenhouse gas pollution.” Therefore, CBD claimed that “finalizing the Rule is likely to result in a significant increase of CO₂ emissions and worsen sea-level rise” and “triggers NHTSA’s legal duty under the ESA to consult on how continued habitat loss due to sea-level rise will adversely affect the loggerhead sea turtle and other listed species threatened by sea-level rise.” In the Final SEIS, NHTSA estimates that the sea-level rise in 2100 associated with Preferred Alternative would be 0.05 centimeter. Such a level is too small to have any meaningful impact on land or water use or a natural resource of the coastal zone. Furthermore, as this final rule amends CAFE standards that increase each year for MYs 2024–2026, this action will result in reductions in sea-level rise resulting from climate change compared to the sea-level rise that would result from the 2020 final rule standards. NHTSA continues to conclude that the CZMA is not applicable to this rulemaking.

NHTSA has, however, conducted a qualitative review in the Final SEIS of the related direct, indirect, and cumulative impacts, positive or negative, of the alternatives on

¹³⁰⁶ 40 CFR 93.152.

¹³⁰⁷ See, e.g., *Dep’t of Transp. v. Pub. Citizen*, 541 U.S. 752, 772–73 (2004); *S. Coast Air Quality Mgmt. Dist. v. Fed. Energy Regulatory Comm’n*, 621 F.3d 1085, 1101 (9th Cir. 2010).

¹³⁰⁸ Section 106 is now codified at 54 U.S.C. 306108. Implementing regulations for the Section 106 process are located at 36 CFR part 800.

¹³⁰⁹ 16 U.S.C. 1456(c)(1)(A).

potentially affected resources, including coastal zones.

6. Endangered Species Act (ESA)

Under Section 7(a)(2) of the Endangered Species Act (ESA), Federal agencies must ensure that actions they authorize, fund, or carry out are “not likely to jeopardize the continued existence” of any federally listed threatened or endangered species (collectively, “listed species”) or result in the destruction or adverse modification of the designated critical habitat of these species.¹³¹⁰ If a Federal agency determines that an agency action may affect a listed species or designated critical habitat, it must initiate consultation with the appropriate Service—the U.S. Fish and Wildlife Service (FWS) of the Department of the Interior (DOI) or the National Oceanic and Atmospheric Administration’s National Marine Fisheries Service of the Department of Commerce (together, “the Services”) or both, depending on the species involved—in order to ensure that the action is not likely to jeopardize the species or destroy or adversely modify designated critical habitat.¹³¹¹ Under this standard, the Federal agency taking action evaluates the possible effects of its action and determines whether to initiate consultation.¹³¹²

The Section 7(a)(2) implementing regulations require consultation if a Federal agency determines its action “may affect” listed species or critical habitat.¹³¹³ The regulations define “effects of the action” as “all consequences to listed species or critical habitat that are caused by the proposed action, including the consequences of other activities that are caused by the proposed action. A consequence is caused by the proposed action if it would not occur *but for* the proposed action and it is *reasonably certain to occur*.”¹³¹⁴ The definition makes explicit a “but for” test and the concept of “reasonably certain to occur” for all effects.¹³¹⁵ The Services have defined

“but for” causation to mean “that the consequence in question would not occur if the proposed action did not go forward. . . . In other words, if the agency fails to take the proposed action and the activity would still occur, there is no ‘but for’ causation. In that event, the activity would not be considered an effect of the action under consultation.”¹³¹⁶

The ESA regulations also provide a framework for determining whether consequences are caused by a proposed action and are therefore “effects” that may trigger consultation. The regulations provide in part:

To be considered an effect of a proposed action, a consequence must be caused by the proposed action (*i.e.*, the consequence would not occur but for the proposed action and is reasonably certain to occur). A conclusion of reasonably certain to occur must be based on clear and substantial information, using the best scientific and commercial data available. Considerations for determining that a consequence to the species or critical habitat is not caused by the proposed action include, but are not limited to:

(1) The consequence is so remote in time from the action under consultation that it is not reasonably certain to occur; or

(2) The consequence is so geographically remote from the immediate area involved in the action that it is not reasonably certain to occur; or

(3) The consequence is only reached through a lengthy causal chain that involves so many steps as to make the consequence not reasonably certain to occur.¹³¹⁷

The regulations go on to make clear that the action agency must factor these

and indirect effects of an action on the species or critical habitat, together with the effects of other activities that are interrelated or interdependent with that action, that will be added to the environmental baseline.” 50 CFR 402.02 (as in effect prior to Oct. 28, 2019). Indirect effects were defined as “those that are caused by the proposed action and are later in time, but still are reasonably certain to occur.” *Id.*

¹³¹⁶ 84 FR 44977 (Aug. 27, 2019) (“As discussed in the proposed rule, the Services have applied the ‘but for’ test to determine causation for decades. That is, we have looked at the consequences of an action and used the causation standard of ‘but for’ plus an element of foreseeability (*i.e.*, reasonably certain to occur) to determine whether the consequence was caused by the action under consultation.”). We note that as the Services do not consider this to be a change in their longstanding application of the ESA, this interpretation applies equally under the prior regulations (which were effective through October 28, 2019), and the current regulations.

¹³¹⁷ 50 CFR 402.17(b).

considerations into its assessments of potential effects.¹³¹⁸

The Services have previously provided legal and technical guidance about whether CO₂ emissions associated with a specific proposed Federal action trigger ESA Section 7(a)(2) consultation. NHTSA analyzed the Services’ history of actions, analysis, and guidance in Appendix G of the MY 2012–2016 CAFE standards EIS and now incorporate by reference that appendix in this preamble.¹³¹⁹ In that appendix, NHTSA looked at the history of the Polar Bear Special Rule (73 FR 76249, Dec. 16, 2008) and several guidance memoranda provided by FWS and the U.S. Geological Survey. Ultimately, DOI concluded that a causal link could not be made between CO₂ emissions associated with a proposed Federal action and specific effects on listed species; therefore, no Section 7(a)(2) consultation would be required.

Subsequent to the publication of that appendix, a court vacated the Polar Bear Special Rule on NEPA grounds, though it upheld the ESA analysis as having a rational basis.¹³²⁰ FWS then issued a revised final special rule for the Polar Bear.¹³²¹ In that final rule, FWS provided that for ESA Section 7, the determination of whether consultation is triggered is narrow and focused on the discrete effect of the proposed agency action. FWS wrote, “[T]he consultation requirement is triggered only if there is a causal connection between the proposed action and a discernible effect to the species or critical habitat that is reasonably certain to occur. One must be able to ‘connect the dots’ between an effect of a proposed action and an impact to the species and there must be a reasonable certainty that the effect will occur.”¹³²² The statement in the revised final special rule is consistent with the prior guidance published by FWS and remains valid today.¹³²³ Likewise, the current regulations identify remoteness in time, geography, and the causal chain as factors to be considered in assessing

¹³¹⁸ 50 CFR 402.17(c) (“The provisions in paragraphs (a) and (b) of this section must be considered by the action agency and the Services.”).

¹³¹⁹ Available on NHTSA’s Corporate Average Fuel Economy website at <https://one.nhtsa.gov/Laws-&Regulations/CAFE-%E2%80%93-Fuel-Economy/Final-EIS-for-CAFE-Passenger-Cars-and-Light-Trucks,-Model-Years-2012%E2%80%932016>.

¹³²⁰ *In re: Polar Bear Endangered Species Act Listing and Section 4(D) Rule Litigation*, 818 F.Supp.2d 214 (D.D.C. Oct. 17, 2011).

¹³²¹ 78 FR 11766 (Feb. 20, 2013).

¹³²² 78 FR 11784–11785 (Feb. 20, 2013).

¹³²³ See DOI Solicitor’s Opinion No. M–37017, “Guidance on the Applicability of the Endangered Species Act Consultation Requirements to Proposed Actions Involving the Emissions of Greenhouse Gases” (Oct. 3, 2008).

¹³¹⁰ 16 U.S.C. 1536(a)(2).

¹³¹¹ See 50 CFR 402.14.

¹³¹² See 50 CFR 402.14(a) (“Each Federal agency shall review its actions at the earliest possible time to determine whether any action may affect listed species or critical habitat.”).

¹³¹³ 50 CFR 402.14(a). The recently issued final rule revising the regulations governing the ESA Section 7 consultation process. 84 FR 44976 (Aug. 27, 2019). The effective date of the new regulations was subsequently delayed to October 28, 2019. 84 FR 50333 (Sept. 25, 2019). As discussed in the text that follows, NHTSA believes that the conclusion would be the same under both the current and prior regulations.

¹³¹⁴ 50 CFR 402.02 (emphasis added), as amended by 84 FR 44976, 45016 (Aug. 27, 2019).

¹³¹⁵ The Services’ prior regulations defined “effects of the action” in relevant part as “the direct

whether a consequence is “reasonably certain to occur.” If the consequence is not reasonably certain to occur, it is not an “effect of a proposed action” and does not trigger the consultation requirement.

In the NPRM for this action, NHTSA stated that pursuant to Section 7(a)(2) of the ESA, the agency considered the effects of the proposed standards and reviewed applicable ESA regulations, case law, and guidance to determine what, if any, impact there might be to listed species or designated critical habitat. NHTSA considered issues related to emissions of CO₂ and other GHGs, and issues related to non-GHG emissions. NHTSA stated that based on this assessment, the agency determined that the action of setting CAFE standards does not require consultation under Section 7(a)(2) of the ESA. NHTSA received one comment on its analysis of obligations under the ESA, which is summarized below.

The Center for Biological Diversity (CBD) provided two reasons why they believe the rule “triggers NHTSA’s procedural duty to undergo Section 7 consultation.”¹³²⁴ First, CBD stated that NHTSA’s adoption of the proposed alternative is discretionary and if “an agency has any statutory discretion over the action in question, that agency has the authority, and thus the responsibility, to comply with the ESA.”¹³²⁵ CBD argued that NHTSA, in its discretion to adopt less stringent standards than the strongest alternative analyzed, or even a stronger alternative than the most stringent alternative analyzed, directly ties NHTSA’s action to harm to listed species and critical habitat. CBD stated that although the rule would reduce the total amount of greenhouse gas and other emissions compared to the baseline (*i.e.*, the 2020 final rule), NHTSA’s decision to finalize this rule would nonetheless allow cars and light trucks to emit millions of metric tons of greenhouse gases and tens of thousands of tons of criteria pollutants. CBD stated that the increases in greenhouse gas emissions between alternatives, specifically between the proposal’s alternative 2 and alternative 3, are not insignificant, and they can be directly tied to harm to species or critical habitat, such as to precise losses of sea ice and sea ice days in the Arctic. CBD also stated that NHTSA is “making the discretionary decision to include a number of different regulatory flexibilities and credits, which allow

manufacturers to avoid or delay producing vehicles that would reduce their emissions.” CBD concluded that by undergoing consultation under the ESA, NHTSA could make discretionary decisions, such as regarding stringency levels and uses of credits and other flexibilities, that mitigate these effects.

Second, CBD stated that NHTSA’s adoption of the rule is an “action” under the ESA, that “may affect” endangered species or their habitat. CBD stated that the “may affect” standard includes “[a]ny possible effect, whether beneficial, benign, adverse or of an undetermined character”, citing the 1986 final rule on interagency cooperation under the ESA. CBD stated that “the increases in greenhouse gas and criteria emissions—associated with the agency decisions described above—may impact the hundreds of federally protected species and their critical habitats that are imperiled due specifically to exacerbated climate change, nitrogen deposition, and greater levels of particular air pollutants from vehicle emissions.”

NHTSA has again reviewed applicable ESA regulations, case law, guidance, and rulings in assessing the potential for impacts on threatened and endangered species from the final CAFE standards. NHTSA disagrees that the agency’s discretion to select an alternative under EPCA/EISA means that the agency is required to undertake ESA consultation. That a statute gives an agency discretion does not by itself bring an agency action under the ESA’s consultation requirements; again, Section 7 imposes a duty to consult with the Services “before engaging in any discretionary action that may affect a listed species or critical habitat.”¹³²⁶ First, “to trigger the ESA consultation requirement, the discretionary control retained by the federal agency also must have the capacity to inure to the benefit of a protected species.”^{1327 1328} And

¹³²⁴ *Karuk Tribe of California v. U.S. Forest Serv.*, 681 F.3d 1006, 1020 (9th Cir. 2012).

¹³²⁷ *Id.* See also *Sierra Club v. Babbitt*, 65 F.3d 1502, 1509 (9th Cir. 1995).

¹³²⁸ CBD cites the D.C. Circuit for the proposition that if “an agency has any statutory discretion over the action in question, that agency has the authority, and thus the responsibility, to comply with the ESA.” However, the D.C. Circuit’s summary of an agency’s obligation under the ESA is not so pointed; rather “Under the ESA, government agencies are obligated to protect endangered and threatened species to the extent that their governing statutes provide them the discretion to do so.” See *Am. Rivers v. U.S. Army Corps of Engineers*, 271 F. Supp. 2d 230, 251 (D.D.C. 2003) (citing *Platte River Whooping Crane Critical Habitat Maintenance Trust v. Federal Energy Regulatory Comm’n*, 962 F.2d 27, 34 (D.C. Cir. 1992) (The ESA “directs agencies to ‘utilize their authorities’ to carry out the ESA’s objectives; it does not expand the powers conferred on an

second, as discussed above, the determination of whether an action will have an effect is subject to longstanding interpretation of the Services’ regulations, including a “but-for” test. Again, the Services have defined “but for” causation to mean “that the consequence in question would not occur if the proposed action did not go forward. . . . In other words, if the agency fails to take the proposed action and the activity would still occur, there is no ‘but for’ causation. In that event, the activity would not be considered an effect of the action under consultation.”¹³²⁹

NHTSA is not able to make a causal link for purposes of Section 7(a)(2) that would “connect the dots” between this action, vehicle emissions from motor vehicles affected by this action, climate change and criteria pollutant emissions, and particular impacts to listed species or critical habitats. The purpose of Section 7(a)(2) consultation is to ensure that Federal agencies are not undertaking, funding, permitting, or authorizing actions that are likely to jeopardize the continued existence of listed species or destroy or adversely modify designated critical habitat.¹³³⁰ With this final rule, NHTSA is not requiring, authorizing, funding, or carrying out the production or refining of fuel (*i.e.*, a proximate cause of upstream emissions),¹³³¹ the operation of motor vehicles, both in regards to vehicle miles traveled and driving location (*i.e.*, the proximate cause of

agency by its enabling act.”) (emphasis in original) (internal citation and quotations omitted); *American Forest & Paper Ass’n v. EPA*, 137 F.3d 291, 299 (5th Cir. 1998): (The ESA “serves not as a font of new authority, but as something far more modest: A directive to agencies to channel their existing authority in a particular direction.”).

¹³²⁹ 84 FR 44977 (Aug. 27, 2019) (“As discussed in the proposed rule, the Services have applied the ‘but for’ test to determine causation for decades. That is, we have looked at the consequences of an action and used the causation standard of ‘but for’ plus an element of foreseeability (*i.e.*, reasonably certain to occur) to determine whether the consequence was caused by the action under consultation.”). We note that as the Services do not consider this to be a change in their longstanding application of the ESA, this interpretation applies equally under the prior regulations (which were effective through October 28, 2019), and the current regulations.

¹³³⁰ 16 U.S.C. 1536.

¹³³¹ NHTSA notes that upstream emissions sources, such as oil extraction sites and fuel refineries, remain subject to the ESA. As future non-Federal activities become reasonably certain, Section 7 and/or other sections of the ESA may provide protection for listed species and designated critical habitats. For example, new oil exploration or extraction activity may result in permitting or construction activities that would trigger consultation or other activities for the protection of listed species or designated critical habitat, as impacts may be more direct and more certain to occur.

¹³²⁴ Docket No. NHTSA–2021–0053–1549.

¹³²⁵ NHTSA–2021–0053–1549, at 4 (citing *Am. Rivers v. United States Army Corps of Eng’rs*, 271 F.Supp.2d 230, 251 (D.D.C. 2003)).

downstream emissions), the use of land that is critical habitat for any purpose, or the taking of any listed species or other activity that may affect any listed species. There is a complex and lengthy chain of causality between NHTSA's action of setting standards and the listed actions, which is highly dependent on (1) both manufacturer's and consumer's behavior, and (2) the nature of climate change and criteria pollutant emissions, which makes any impacts of this action uncertain. Regardless of the level of stringency at which NHTSA sets CAFE standards, criteria pollutant and CO₂ emissions from these upstream and downstream emissions sources will change to a greater or lesser degree because of several independent factors, including those which are explicitly authorized by EPCA/EISA.

This leads NHTSA to the same conclusion as the proposal: The resulting impacts of this action to listed species or critical habitat does not satisfy the "but for" test and impacts are not "reasonably certain to occur." Because NHTSA concludes there are "no effects," Section 7(a)(2) consultation is not required.

(a) NHTSA's Action Does Not Give the Agency Discretionary Control Over Emissions, Nor Does It Satisfy the Services' "But-for" Test for Effects Under the ESA

NHTSA is statutorily obligated to set attribute-based CAFE standards for each model year at the levels it determines are "maximum feasible."¹³³² "Maximum feasible" involves the balancing of four factors—technological feasibility, economic practicability, the effect of other motor vehicle standards of the government on fuel economy, and the need of the United States to conserve energy—while also considering EPCA's primary purpose: Energy conservation. NHTSA selects a range of alternatives to consider when setting standards in each regulatory action, and that range encompasses a spectrum of possible standards NHTSA could determine is maximum feasible based on the different ways the agency could weigh EPCA's four statutory factors.

First, NHTSA disagrees with CBD that simply because EPCA/EISA gives the agency discretion to set standards then

¹³³² See 49 U.S.C. 32902(a) ("At least 18 months before the beginning of each model year, the Secretary of Transportation shall prescribe by regulation average fuel economy standards for automobiles manufactured by a manufacturer in that model year. Each standard shall be the maximum feasible average fuel economy level that the Secretary decides the manufacturers can achieve in that model year.").

NHTSA is required to undertake Section 7(a)(2) consultation. Again, "to trigger the ESA consultation requirement, the discretionary control retained by the federal agency also must have the capacity to inure to the benefit of a protected species."¹³³³ If NHTSA does not set standards, vehicle-related upstream and downstream emissions will still occur; if NHTSA sets more or less stringent standards than those finalized in this action, emissions will still occur. Moreover, NHTSA disagrees that the differences in emissions between Alternative 2 and Alternative 3 can be directly tied to harm to species or critical habitat. There is no way to meaningfully differentiate between the alternatives (or an unanalyzed alternative more stringent than Alternative 3) in terms of outcomes for listed species and designated critical habitat. At most, NHTSA can only posit that more stringent standards hypothetically could lead to better outcomes. But where to draw the line in terms of impacts to species and habitats is an impossible exercise.

In addition, as outlined below, the causal chain between NHTSA's action of setting standards and vehicle emissions is broken by actions from third parties at several steps, and similarly with the chain between vehicle emissions and impacts to listed species or threatened habitats. This means that NHTSA's action does not meet the Services' tests for "but for" causation.

First, NHTSA's action here is to codify for each model year coefficients that manufacturers input to a mathematical formula to determine their corporate average fuel economy standard based on their vehicles' footprints and sales volumes. The footprint-based standards approach, dictated by EPCA/EISA, gives manufacturers significant discretion to design, produce, and sell motor vehicles to meet different objectives. Because manufacturers could choose to produce more vehicles with larger footprints (and therefore less stringent standards), fleet-average CO₂ emissions could increase to some extent year-over-year independently of where NHTSA sets standards. Or the opposite may be true, and a shift in consumer preferences could lead to increased production of vehicles with smaller footprints (and therefore more stringent standards), resulting in overall declines in CO₂ emissions in the future compared to what NHTSA is forecasting.

¹³³³ *Id.* See also *Sierra Club v. Babbitt*, 65 F.3d 1502, 1509 (9th Cir. 1995).

In addition, Congress provided several flexibilities in EPCA/EISA that influence how manufacturers produce vehicles for sale in a model year. Manufacturers can trade and apply credits that have been earned from over-compliance in lieu of meeting the applicable standards for a particular model year, and in fact manufacturers have planned to rely on credits to comply with the standards for the model years regulated by this action. Furthermore, the program allows manufacturers to pay civil penalties to cover any shortfall in compliance, further offsetting potential improvements in fuel economy (and, therefore, changes in air pollutant and CO₂ emissions). Importantly, NHTSA does not have discretion to limit either of these program flexibilities, contrary to CBD's comment, as they both are prescribed by Congress. Both flexibilities could offset any changes in emissions that would result from the final decision.

Consumers also play a role in which vehicles are sold and how those vehicles are driven. Vehicle manufacturers can choose to apply different fuel-economy-improving technologies to their vehicles that result in different fuel economy and CO₂ and criteria pollutant emissions, and they do in part based on consumer demand. NHTSA carries forward sales projections for each vehicle in the analysis based on historic data; however, the agency cannot control the fleet mix that a manufacturer ultimately sells. Moreover, while NHTSA makes projections about much consumers may choose to drive vehicles for purposes of setting standards, based on data that includes odometer readings, economic data, and other factors, NHTSA does not have any control over the drivers' actual VMT. While VMT is affected by the cost of driving associated with fuel economy (*i.e.*, the rebound effect), it is also affected by several factors, such as economic conditions, that are beyond NHTSA's control.

The fact that CO₂ and criteria pollutant emissions will continue after NHTSA's action on standards cannot, alone, trigger Section 7(a)(2) consultation.¹³³⁴ Again, consultation is not required where an agency lacks discretion to take action that will inure

¹³³⁴ *National Ass'n of Home Builders v. Defenders of Wildlife*, 551 U.S. 644, 673 (2007) ("Applying *Chevron*, we defer to the [agency's] reasonable interpretation of ESA [section] 7(a)(2) as applying only to 'actions in which there is discretionary Federal involvement or control.'" (quoting 50 CFR 402.03)).

to the benefit of listed species.¹³³⁵ Ultimately, the relevant decisions that result in emissions are taken by third parties, and any on-the-ground activities to implement and carry out those decisions are undertaken by such third parties. This means that emissions will never uniformly increase or decrease for all future model years, across all regulated pollutants, and in all locations throughout the country. The only factor that NHTSA has control over is what level of stringency to set in each model year.

(a) NHTSA Cannot Control Greenhouse Gas and Criteria Pollutant Emissions From Motor Vehicle Impacts to Listed Species or Critical Habitat

The mechanics of climate change and both upstream and downstream criteria air pollutant emissions further break the chain of causality between NHTSA's action and specific effects on listed species or designated critical habitat.

Climate change is a global phenomenon, impacted by greenhouse gas emissions that could occur anywhere throughout the world. As these gases accumulate in the atmosphere, radiative forcing increases, resulting in various potential impacts to the global climate system (e.g., warming temperatures, droughts, and changes in ocean pH) over long time scales. These changes could directly or indirectly impact listed species and/or designated critical habitat over time. Although this is a simplified explanation of a complex phenomenon subject to a significant degree of scientific study, it illustrates that the potential climate change-related consequences of this rulemaking on listed species and designated critical habitat are not "reasonably certain to occur" under any of the three tests in the ESA regulations and listed above. Not only are the consequences to listed species or designated critical habitat geographically and temporally remote from the emissions that result from regulated vehicles, the chain of causality is simply too lengthy and complex. Because impacts to listed species and designated critical habitat result from climate shifts that, in and of themselves, result from the accumulation over time of greenhouse gas emissions from anywhere in the world, NHTSA cannot "connect the dots" between the emissions from a regulated vehicle and those impacts. While the potential impacts of climate change have been well-documented,

there is no degree of certainty, using available data or tools, that this action (as distinct from any other source of CO₂ emissions) would be the cause of any particular impact to listed species or critical habitats.¹³³⁶

The chain of causality between this action and specific impacts from criteria pollutant emissions on listed species or designated critical habitat is similarly attenuated. Emissions of upstream and tailpipe criteria pollutant emissions are determined by similar manufacturer and driver controls as discussed above,¹³³⁷ meaning that the impacts of CAFE standards on criteria pollutants is indirect. As shown in the preamble and Final SEIS, the impacts of all alternatives on the emissions of criteria pollutants are small,¹³³⁸ and they increase and decrease based on pollutant and emissions type (i.e., upstream or downstream). However, while small in magnitude, net impacts could also vary among different geographic areas depending on the locations of upstream emission sources and where changes in highway travel occur. NHTSA has no way of knowing, with reasonable certainty, where these impacts would occur. Current modeling tools available are not designed to trace fluctuations in ambient concentration levels of criteria and toxic air pollutants to potential impacts on particular endangered species. NHTSA therefore cannot conclude that impacts related to the emissions of criteria air pollutants from fuel processes or vehicles are "reasonably certain to occur" to listed species or critical habitat.¹³³⁹

For these reasons, NHTSA concludes that any consequence to specific listed species or designated critical habitats from climate change or other air pollutant emissions is too remote and uncertain to be attributable to this action. The consequences of this action

¹³³⁶ See 50 CFR 402.17(b) ("A conclusion of reasonably certain to occur must be based on clear and substantial information, using the best scientific and commercial data available.").

¹³³⁷ In addition to the factors discussed above, vehicles produced in the model years covered by this action are subject to EPA's tailpipe emissions standards, and these standards are expected to become increasingly stringent over the timeframe covered by this rulemaking. However, the technologies used to increase fuel economy are not the same technologies that are used to decrease tailpipe emissions, so an increase in the first will not necessarily result in a decrease in the latter. That said, as discussed in the preamble above and further in the Final SEIS, total emissions from vehicles have declined dramatically since 1970 due to EPA regulation of vehicles and fuels.

¹³³⁸ For more information, see Chapter 4 of the Final SEIS.

¹³³⁹ See 50 CFR 402.17 ("A conclusion of reasonably certain to occur must be based on clear and substantial information, using the best scientific and commercial data available").

therefore are not "effects" for purposes of consultation under Section 7(a)(2), and this action has not triggered ESA consultation. Accordingly, NHTSA has concluded its review of this action under Section 7 of the ESA.

7. Floodplain Management (Executive Order 11988 and DOT Order 5650.2)

These orders require Federal agencies to avoid the long- and short-term adverse impacts associated with the occupancy and modification of floodplains, and to restore and preserve the natural and beneficial values served by floodplains. Executive Order 11988 also directs agencies to minimize the impacts of floods on human safety, health and welfare, and to restore and preserve the natural and beneficial values served by floodplains through evaluating the potential effects of any actions the agency may take in a floodplain and ensuring that its program planning and budget requests reflect consideration of flood hazards and floodplain management. DOT Order 5650.2 sets forth DOT policies and procedures for implementing Executive Order 11988. The DOT Order requires that the agency determine if a proposed action is within the limits of a base floodplain, meaning it is encroaching on the floodplain, and whether this encroachment is significant. If significant, the agency is required to conduct further analysis of the proposed action and any practicable alternatives. If a practicable alternative avoids floodplain encroachment, then the agency is required to implement it.

In this final rule, NHTSA is not occupying, modifying, and/or encroaching on floodplains. NHTSA therefore concludes that the Orders do not apply to this final rule. NHTSA has, however, conducted a review of the alternatives on potentially affected resources, including floodplains, in its Final SEIS.

8. Preservation of the Nation's Wetlands (Executive Order 11990 and DOT Order 5660.1a)

These orders require Federal agencies to avoid, to the extent possible, undertaking or providing assistance for new construction located in wetlands unless the agency head finds that there is no practicable alternative to such construction and that the final action includes all practicable measures to minimize harms to wetlands that may result from such use. Executive Order 11990 also directs agencies to take action to minimize the destruction, loss, or degradation of wetlands in "conducting Federal activities and programs affecting land use, including

¹³³⁵ *Id.*; *Sierra Club v. Babbitt*, 65 F.3d 1502, 1509 (9th Cir. 1995) (ESA Section 7(a)(2) consultation is not required where an agency lacks discretion to influence private conduct in a manner that will inure to the benefit of listed species).

but not limited to water and related land resources planning, regulating, and licensing activities.” DOT Order 5660.1a sets forth DOT policy for interpreting Executive Order 11990 and requires that transportation projects “located in or having an impact on wetlands” should be conducted to assure protection of the Nation’s wetlands. If a project does have a significant impact on wetlands, an EIS must be prepared.

NHTSA is not undertaking or providing assistance for new construction located in wetlands. NHTSA therefore concludes that these Orders do not apply to this final rule. NHTSA has, however, conducted a review of the alternatives on potentially affected resources, including wetlands, in its Final SEIS.

9. Migratory Bird Treaty Act (MBTA), Bald and Golden Eagle Protection Act (BGEPA), Executive Order 13186

The MBTA (16 U.S.C. 703–712) provides for the protection of certain migratory birds by making it illegal for anyone to “pursue, hunt, take, capture, kill, attempt to take, capture, or kill, possess, offer for sale, sell, offer for barter, barter, offer to purchase, purchase, deliver for shipment, ship, export, import, cause to be shipped, exported, or imported, deliver for transportation, carry or cause to be carried, or receive for shipment, transportation, carriage, or export” any migratory bird covered under the statute.¹³⁴⁰

The BGEPA (16 U.S.C. 668–668d) makes it illegal to “take, possess, sell, purchase, barter, offer to sell, purchase or barter, transport, export or import” any bald or golden eagles.¹³⁴¹ Executive Order 13186, “Responsibilities of Federal Agencies to Protect Migratory Birds,” helps to further the purposes of the MBTA by requiring a Federal agency to develop a Memorandum of Understanding (MOU) with FWS when it is taking an action that has (or is likely to have) a measurable negative impact on migratory bird populations.

NHTSA concludes that the MBTA, BGEPA, and Executive Order 13186 do not apply to this final rule because there is no disturbance, take, measurable negative impact, or other covered activity involving migratory birds or bald or golden eagles involved in this rulemaking.

10. Department of Transportation Act (Section 4(f))

Section 4(f) of the Department of Transportation Act of 1966 (49 U.S.C.

303), as amended, is designed to preserve publicly owned park and recreation lands, waterfowl and wildlife refuges, and historic sites. Specifically, Section 4(f) provides that DOT agencies cannot approve a transportation program or project that requires the use of any publicly owned land from a public park, recreation area, or wildlife or waterfowl refuge of national, State, or local significance, unless a determination is made that:

(1) There is no feasible and prudent alternative to the use of land, and

(2) The program or project includes all possible planning to minimize harm to the property resulting from the use.

These requirements may be satisfied if the transportation use of a Section 4(f) property results in a de minimis impact on the area.

NHTSA concludes that Section 4(f) does not apply to this final rule because this rulemaking is not an approval of a transportation program nor project that requires the use of any publicly owned land.

11. Executive Order 12898: “Federal Actions To Address Environmental Justice in Minority Populations and Low-Income Populations”

Executive Order 12898, “Federal Actions to Address Environmental Justice in Minority Populations and Low-Income Populations” (Feb. 16, 1994), directs Federal agencies to “promote nondiscrimination in federal programs substantially affecting human health and the environment, and provide minority and low-income communities access to public information on, and an opportunity for public participation in, matters relating to human health or the environment.” E.O. 12898 also directs agencies to identify and consider any disproportionately high and adverse human health or environmental effects that their actions might have on minority and low-income communities and provide opportunities for community input in the NEPA process. CEQ has provided agencies with general guidance on how to meet the requirements of the E.O. as it relates to NEPA. A White House Environmental Justice Interagency Council established under E.O. 14008, “Tackling the Climate Crisis at Home and Abroad,” is expected to advise CEQ on ways to update E.O. 12898, including the expansion of environmental justice advice and recommendations. The White House Environmental Justice Interagency Council will advise on increasing environmental justice monitoring and enforcement.

Additionally, the 2021 DOT Order 5610.2(c), “U.S. Department of Transportation Actions to Address Environmental Justice in Minority Populations and Low-Income Populations” (May 14, 2021), describes the process for DOT agencies to incorporate environmental justice principles in programs, policies, and activities. The DOT’s Environmental Justice Strategy specifies that environmental justice and fair treatment of all people means that no population be forced to bear a disproportionate burden due to transportation decisions, programs, and policies. It also defines the term *minority* and *low-income* in the context of DOT’s environmental justice analyses. *Minority* is defined as a person who is Black, Hispanic or Latino, Asian American, American Indian or Alaskan Native, or Native Hawaiian or other Pacific Islander. *Low-income* is defined as a person whose household income is at or below the Department of Health and Human Services poverty guidelines. Low-income and minority populations may live in geographic proximity or be geographically dispersed/transient. In 2021, DOT reviewed and updated its environmental justice strategy to ensure that it continues to reflect its commitment to environmental justice principles and integrating those principles into DOT programs, policies, and activities.

NHTSA’s Draft SEIS provided a qualitative analysis of the affected environment for environmental justice and the environmental consequences for impacted communities. Specifically, NHTSA identified that minority and low-income communities near where oil production and refining occur, areas near roadways, coastal flood-prone areas, and urban heat islands subject to the head island effect would most likely be exposed to the environmental and health effects of oil production, distribution, and consumption, or the impacts of climate change. NHTSA described several ways in which environmental justice communities may be disproportionately impacted by these activities. However, NHTSA concluded that the magnitude of changes in upstream air pollutant emissions would not be characterized as high and adverse, and similarly that the changes in exposure to downstream emissions would be small in comparison to existing conditions. NHTSA also described how climate change could disproportionately affect minority and low-income communities; the agency concluded that even though the impacts of this action on minority and low-income communities would be

¹³⁴⁰ 16 U.S.C. 703(a).

¹³⁴¹ 16 U.S.C. 668(a).

attenuated by a lengthy causal chain, the changes to climate values would be very small and incremental compared to expected changes associated with future global emissions trajectories. NHTSA concluded that the alternatives considered in the proposal and Draft SEIS would not result in disproportionately high and adverse human health effects or environmental effects on minority or low-income populations. This is because the rule sets standards nationwide, and although minority and low-income populations may experience some disproportionate effects or face inequities in receiving some benefits, impacts of the alternatives on human health and the environment would not be high and adverse.

Several commenters, including the California Department of Justice, Office of the Attorney General et al., the American Lung Association, the Environmental Law & Policy Center, the Alliance of Nurses for Healthy Environments, the Asthma and Allergy Foundation of America, GreenLatinos, New Mexico Interfaith Power and Light, National Parks Conservation Association, and the National Religious Partnership for the Environment stated that the projected impacts of NHTSA's proposed standards are likely to be magnified in communities with higher percentages of Black, Asian American, and Latinx residents because refineries and major roadways are disproportionately located in those communities. More specifically, the California Department of Justice, Office of the Attorney General et al. stated that "improvements in air quality anticipated by the proposal will serve [our States and Cities'] environmental justice goals, by improving air quality in communities historically impacted by greater pollution." Other commenters urged NHTSA to consider more stringent alternatives to combat the economic effects to lower-income households as well as the environmental justice effects from changes to criteria and toxic pollution.

NHTSA agrees that minority and low-income populations are disproportionately affected by changes in criteria and air toxic pollutant emissions, as noted by numerous commenters. Based on comments and additional information available since the Draft SEIS, NHTSA updated its qualitative discussion of environmental justice impacts in the Final SEIS to incorporate peer-reviewed sources and additional data points on public health and vulnerable populations. In addition, the Final SEIS incorporates new information from EPA on health effects

due to PM_{2.5} and differential vulnerabilities due to climate change.

Based on the analysis presented in the Final SEIS, the agency has determined that this rulemaking (and alternatives considered) would not result in disproportionately high and adverse human health or environmental effects on minority or low-income populations. To the extent that minority and low-income populations live closer to oil refining facilities, these populations may be more likely to be adversely affected by the emissions of the Proposed Action and alternatives. As noted, a correlation between proximity to oil refineries and the prevalence of minority and low-income populations is suggested in the scientific literature. However, the magnitude of the change in emissions relative to the baseline is minor and would not be characterized as high and adverse. To the extent that minority and low-income populations disproportionately live or attend schools near major roadways, these populations may be more likely to be adversely affected by the Proposed Action and alternatives. However, the change in the level of exposure would be small in comparison to the existing conditions in these areas.

NHTSA's Final SEIS finds that all action alternatives would bring benefits to air quality and human health by reducing air-quality-related adverse health impacts nationwide by 2025, 2035, and 2050. In general, Alternative 1 provides the largest decrease in adverse health impacts by 2025, while Alternative 3 would provide the largest decrease by 2035 and 2050. In all alternatives, adverse health impacts would decrease over time due to increasing stringency as action alternatives are implemented.

Finally, any impacts of this rulemaking on low-income and minority communities due to climate change would be attenuated by a lengthy causal chain; but if one could attempt to draw those links, the changes to climate values would be very small and incremental compared to the expected changes associated with the future global emissions trajectories.

This rulemaking would set standards nationwide, and although minority and low-income populations may experience some disproportionate effects, in particular locations, the overall impacts on human health and the environment would not be "high and adverse" under E.O. 12898. Section VI and the Final SEIS contain further discussion of NHTSA's consideration of environmental justice issues associated with this action.

12. Executive Order 13045: "Protection of Children From Environmental Health Risks and Safety Risks"

This action is subject to Executive Order 13045 (62 FR 19885, Apr. 23, 1997) because it is an economically significant regulatory action as defined by E.O. 12866, and NHTSA has reason to believe that the environmental health and safety risks related to this action, although small, may have a disproportionate effect on children. Specifically, children are more vulnerable to adverse health effects related to mobile source emissions, as well as to the potential long-term impacts of climate change. Pursuant to E.O. 13045, NHTSA must prepare an evaluation of the environmental health or safety effects of the planned regulation on children and an explanation of why the planned regulation is preferable to other potentially effect and reasonably feasible alternatives considered by NHTSA. Further, this analysis may be included as part of any other required analysis.

All of the action alternatives would reduce CO₂ emissions relative to the baseline and thus have positive effects on mitigating global climate change, and thus environmental and health effects associated with climate change. While environmental and health effects associated with criteria pollutant and toxic air pollutant emissions vary over time and across alternatives, negative effects, when estimated, are extremely small. This preamble and the agency's Final SEIS discuss air quality, climate change, and their related environmental and health effects, noting where these would disproportionately affect children. In addition, Section VI of this preamble explains why NHTSA believes that the final standards are preferable to other alternatives considered. Together, this preamble and Final SEIS satisfy NHTSA's responsibilities under E.O. 13045.

13. Executive Order 13211: "Energy Effects"

Executive Order 13211, "Energy Effects", requires agencies prepare a Statement of Energy Effects that describes the effects of certain regulatory actions on energy supply, distribution, and use. This action is not a "significant energy action" under the Executive order because it is not likely to have a significant adverse effect on the supply, distribution, or use of energy. We have outlined the energy effects in Table I-3 above and elsewhere in this preamble and associated FRIA, and those results are briefly summarized

here. This action reduces fuel use for passenger cars and light trucks under revised fuel economy standards, which will result in significant reductions of the consumption of petroleum, will achieve energy security benefits, and have no adverse energy effects. Because our final fuel economy standards result in significant fuel savings, this rule encourages more efficient use of fuels. We estimate that the final standards will save approximately 234 billion gallons of gasoline through 2050.

E. Regulatory Flexibility Act

Pursuant to the Regulatory Flexibility Act (5 U.S.C. 601 *et seq.*, as amended by the Small Business Regulatory Enforcement Fairness Act (SBREFA) of 1996), whenever an agency is required to publish a notice of proposed rulemaking or final rule, it must prepare and make available for public comment a regulatory flexibility analysis that describes the effect of the rule on small

entities (*i.e.*, small businesses, small organizations, and small governmental jurisdictions). No regulatory flexibility analysis is required if the head of an agency certifies the rule will not have a significant economic impact on a substantial number of small entities. SBREFA amended the Regulatory Flexibility Act to require Federal agencies to provide a statement of the factual basis for certifying that a rule will not have a significant economic impact on a substantial number of small entities.

We have considered the impacts of this final rule under the Regulatory Flexibility Act and certify that this final rule will not have a significant economic impact on a substantial number of small entities. The following is NHTSA's statement providing the factual basis for this certification pursuant to 5 U.S.C. 605(b).

Small businesses are defined based on the North American Industry

Classification System (NAICS) code.¹³⁴² One of the criteria for determining size is the number of employees in the firm. For establishments primarily engaged in manufacturing or assembling automobiles, as well as light duty trucks, the firm must have less than 1,500 employees to be classified as a small business. This rule would affect motor vehicle manufacturers. As shown in Table VIII-1, the agency has identified 14 small manufacturers of passenger cars, light trucks, and SUVs of electric, hybrid, and internal combustion engines. We acknowledge that some newer manufacturers may not be listed. However, many of those new manufacturers tend to have transportation products that are not part of the light-duty vehicle fleet and have yet to start production of light-duty vehicles. Moreover, we do not believe that there are a "substantial number" of these newer companies.¹³⁴³

Table VIII-1 – Small Domestic Vehicle Manufacturers

Manufacturers	Founded	Employees ¹³⁴⁴	Estimated Annual Production ¹³⁴⁵	Sale Price per Unit
Karma Automotive	2014	< 1,000	<100	\$95,000 to \$120,000
BXR Motors	2008	< 10	< 100	\$155,000 to \$185,000
Falcon Motorsports	2009	< 10	< 100	\$300,000 to \$400,000
Lucra Cars	2005	< 50	< 100	\$70,000 to \$220,000
Lyons Motor Car	2012	< 10	< 100	\$1,400,000
Rezvani Motors	2014	< 10	< 100	\$155,000 to \$260,000
Rossion Automotive	2007	< 50	< 100	\$90,000
Saleen	1984	< 200	< 100	\$100,000
Shelby American	1962	< 200	< 100	\$60,000 to \$250,000
Panoz	1988	< 50	< 100	\$155,000 to \$175,000
Faraday Future	2014	< 1,000	0	\$200,000 to \$300,000
SF Motors	2016	< 500	0	N/A
Workhorse Group	2007	< 200	0	\$52,000
Lordstown Motors	2019	<1,000	0	\$52,500
Bollinger Motors	2014	<1,000	0	\$125,500

¹³⁴² Classified in NAICS under Subsector 336—Transportation Equipment Manufacturing for Automobile Manufacturing (336111), Light Truck

(336112), and Heavy Duty Truck Manufacturing (336120). <https://www.sba.gov/document/support-table-size-standards> (accessed: February 10, 2022).

¹³⁴³ 5 U.S.C. 605(b).

We believe that the final rulemaking would not have a significant economic impact on small vehicle manufacturers because under 49 CFR part 525, passenger vehicle manufacturers building fewer than 10,000 vehicles per year can petition NHTSA to have alternative standards set for those manufacturers. Listed manufacturers producing ICE vehicles do not currently meet the standard and must already petition the agency for relief. If the standard is raised, it has no meaningful impact on these manufacturers—they still must go through the same process and petition for relief. Given there already is a mechanism for relieving burden on small businesses, which is the purpose of the Regulatory Flexibility Act, a regulatory flexibility analysis was not prepared.

Further, small manufacturers of electric vehicles would not face a significant economic impact. The method for earning credits applies equally across manufacturers and does not place small entities at a significant competitive disadvantage. In any event, even if the rule had a “significant economic impact” on these small EV manufacturers, the amount of these companies is not “a substantial number.”¹³⁴⁶ For these reasons, their existence does not alter the agency’s analysis of the applicability of the Regulatory Flexibility Act.

F. Executive Order 13132 (Federalism)

Executive Order 13132 requires Federal agencies to develop an accountable process to ensure “meaningful and timely input by State and local officials in the development of regulatory policies that have federalism implications. The order defines the term “[p]olicies that have federalism implications” to include regulations that have “substantial direct effects on the States, on the relationship between the national government and the States, or on the distribution of power and responsibilities among the various levels of government.” Under the order, agencies may not issue a regulation that has federalism implications, that imposes substantial direct compliance costs, unless the Federal Government provides the funds necessary to pay the direct compliance costs incurred by the State and local governments, or the agencies consult with State and local officials early in the process of developing the proposed regulation.

¹³⁴⁴ Estimated number of employees as of June 2021, source: *LinkedIn.com* and other websites reporting company profiles.

¹³⁴⁵ Rough estimate of light duty vehicle production for MY 2020.

¹³⁴⁶ 5 U.S.C. 605.

Similar to the CAFE preemption final rule,¹³⁴⁷ NHTSA does not believe that this final rule implicates E.O. 13132, because it neither imposes substantial direct compliance costs on State, local, or Tribal governments, nor does it preempt State law. Thus, this final rule does not implicate the consultation procedures that E.O. 13132 imposes on agency regulations that would either preempt State law or impose substantial direct compliance costs on State, local, or Tribal governments, because the only entities subject to this final rule are vehicle manufacturers. Nevertheless, NHTSA has complied with the Order’s requirements and consulted directly with the California Air Resources Board in developing a number of elements of this final rule.

NHTSA received several comments on CAFE preemption under 49 U.S.C. 32919: Some stating that State regulations like California’s were preempted, and others urging NHTSA to take a substantive stance beyond what the preemption final rule set forth. With regard to the federalism implications of the final rule, NHTSA has spoken to this issue separately at 86 FR 74236 (Dec. 29, 2021), “Corporate Average Fuel Economy (CAFE) Preemption” final rule. NHTSA is taking no positions on EPCA preemption in this final rule beyond those already expressed in that separate preemption final rule. Moreover, to the extent that any analysis in this final rule discusses State regulatory programs, including any from California under Section 209 of the Clean Air Act or other states under Section 177 of the Clean Air Act, such analysis also does not implicate E.O. 13132. As explained previously herein in response to commenters, this final rule does not entail a legal determination of the validity of such programs, including any assessment of how or whether any such programs may be affected by 49 U.S.C. 32919. In fact, as NHTSA recently explained in the CAFE preemption final rule, NHTSA lacks the legal authority to legally dictate the scope of EPCA preemption in this manner and, instead, the legal status of any such programs is more appropriately adjudicated in a judicial forum.¹³⁴⁸

¹³⁴⁷ See 86 FR 74236, 74365 (Dec. 29, 2021).

¹³⁴⁸ *Id.* at 74238. As a result, NHTSA determined in the CAFE preemption final rule that “While this final rule concerns matters of preemption, it does not entail either type of regulation covered by Executive Order 13132’s consultation requirements.” *Id.* at 74265.

G. Executive Order 12988 (Civil Justice Reform)

Pursuant to Executive Order 12988, “Civil Justice Reform” (61 FR 4729, Feb. 7, 1996), NHTSA has considered whether this rulemaking would have any retroactive effect. This final rule does not have any retroactive effect.

H. Executive Order 13175 (Consultation and Coordination With Indian Tribal Governments)

This final rule does not have tribal implications, as specified in Executive Order 13175 (65 FR 67249, Nov. 9, 2000). This final rule will be implemented at the Federal level and will impose compliance costs only on vehicle manufacturers. Thus, Executive Order 13175, which requires consultation with Tribal officials when agencies are developing policies that have “substantial direct effects” on Tribes and Tribal interests, does not apply to this final rule.

I. Unfunded Mandates Reform Act

Section 202 of the Unfunded Mandates Reform Act of 1995 (UMRA) requires Federal agencies to prepare a written assessment of the costs, benefits, and other effects of a proposed or final rule that includes a Federal mandate likely to result in the expenditure by State, local, or Tribal governments, in the aggregate, or by the private sector, of more than \$100 million in any one year (adjusted for inflation with base year of 1995). Adjusting this amount by the implicit gross domestic product price deflator for 2018 results in \$153 million ($110.296/71.868 = 1.53$).¹³⁴⁹ Before promulgating a rule for which a written statement is needed, section 205 of UMRA generally requires NHTSA to identify and consider a reasonable number of regulatory alternatives and adopt the least costly, most cost-effective, or least burdensome alternative that achieves the objective of the rule. The provisions of section 205 do not apply when they are inconsistent with applicable law. Moreover, section 205 allows NHTSA to adopt an alternative other than the least costly, most cost-effective, or least burdensome alternative if the agency publishes with the rule an explanation of why that alternative was not adopted.

This final rule will not result in the expenditure by State, local, or Tribal governments, in the aggregate, of more than \$153 million annually, but it will

¹³⁴⁹ Bureau of Economic Analysis, National Income and Product Accounts (NIPA), Table 1.1.9 Implicit Price Deflators for Gross Domestic Product. https://bea.gov/iTable/index_nipa.cfm (accessed: February 10, 2022).

result in the expenditure of that magnitude by vehicle manufacturers and/or their suppliers. In developing this final rule, we considered a range of alternative fuel economy standards. As explained in detail in Section VI of the preamble, NHTSA believes that our selected alternative is the maximum feasible alternative that achieves the objectives of this rulemaking, as required by EPCA/EISA.

J. Regulation Identifier Number

The Department of Transportation assigns a regulation identifier number (RIN) to each regulatory action listed in the Unified Agenda of Federal Regulations. The Regulatory Information Service Center publishes the Unified Agenda in April and October of each year. The RIN contained in the heading at the beginning of this document may be used to find this action in the Unified Agenda.

K. National Technology Transfer and Advancement Act

Section 12(d) of the National Technology Transfer and Advancement Act (NTTAA) requires NHTSA evaluate and use existing voluntary consensus standards in its regulatory activities unless doing so would be inconsistent with applicable law (e.g., the statutory provisions regarding NHTSA's vehicle safety authority) or otherwise impractical.¹³⁵⁰

Voluntary consensus standards are technical standards developed or adopted by voluntary consensus standards bodies. Technical standards are defined by the NTTAA as "performance-based or design-specific technical specification and related management systems practices." They pertain to "products and processes, such as size, strength, or technical performance of a product, process or material."

Examples of organizations generally regarded as voluntary consensus standards bodies include the ASTM International, the Society of Automotive Engineers (SAE), and the American National Standards Institute (ANSI). If NHTSA does not use available and potentially applicable voluntary consensus standards, it is required by the Act to provide Congress, through OMB, an explanation of the reasons for not using such standards. There are currently no consensus standards that NHTSA administers relevant to these final CAFE standards.

L. Department of Energy Review

In accordance with 49 U.S.C. 32902(j)(2), NHTSA submitted this rule to the Department of Energy for review.

M. Paperwork Reduction Act

Under the procedures established by the Paperwork Reduction Act of 1995 (PRA), a person is not required to respond to a collection of information by a Federal agency unless the collection displays a valid Office of Management and Budget (OMB) control number. This final rule modifies NHTSA's existing information collection request (ICR) for its Corporate Average Fuel Economy (CAFE) program (OMB control number 2127-0019). NHTSA sought comment on its intention to seek approval from OMB for this modification in the proposal and forwarded the ICR to the Office of Management and Budget (OMB) for approval. OMB deferred approval of this ICR and instructed NHTSA to resubmit the ICR with publication of the final rule. NHTSA is now resubmitting its request for revision of its existing CAFE information collection.

NHTSA's ICR describes the nature of the information collections for the CAFE program and their expected burden. As described in the NPRM, the ICR covers requirements for manufacturers to submit information on CAFE standards, exemptions, vehicles, technologies, and CAFE compliance test results. Manufacturers also provide information on any of the flexibilities and incentives they use during the model year to comply with CAFE standards. These reporting requirements are necessary to ensure compliance with its CAFE program.

In the NPRM, NHTSA proposed changes to the CAFE program's standardized reporting templates for manufacturers to submit information to NHTSA on their vehicle production and CAFE credits used to comply with the CAFE standards. NHTSA proposed making changes to its reporting template for PMY and MMY reports. As noted in the NPRM, these changes are expected to result in additional burden hours to respondents.

NHTSA estimates the total burden of this ICR is 4,861 hours and \$0. This is a change of 843 hours and \$0 (from 4,018 hours and \$0). Most of this burden is a result of the correction of 550 hours for NHTSA's CAFE Credit Value Reporting Requirement. An additional 268 hours are a result of increased trade contracts received by NHTSA since the last PRA. Five of the hours are a result of additional information to be collected in new data fields in the PMY and MMY

reports and the remaining 2 hours are a result of correcting calculations errors from the prior ICR. While NHTSA did not receive any comments about its burden estimates, NHTSA did receive comments on the proposed changes to the templates. NHTSA discusses these comments and the agency's response in the relevant sections above ((See Section VII.A.2.b).1-4). After reviewing the comments, NHTSA is revising the templates to address comments, as discussed above. However, NHTSA determined that no changes to the information collection are warranted. Accordingly, NHTSA is finalizing the burden estimates for the reporting requirements that were proposed in the NPRM. For additional information, see the supporting documentation for this information collection request that is posted to the docket.¹³⁵¹

List of Subjects in 49 CFR Parts 531, 533, 536, and 537

Fuel economy, Reporting and recordkeeping requirements.

For the reasons discussed in the preamble, the National Highway Traffic Safety Administration amends 49 CFR chapter V as follows:

- 1. Revise part 531 to read as follows:

PART 531—PASSENGER AUTOMOBILE AVERAGE FUEL ECONOMY STANDARDS

Sec.

- 531.1 Scope.
- 531.2 Purpose.
- 531.3 Applicability.
- 531.4 Definitions.
- 531.5 Fuel economy standards.
- 531.6 Measurement and calculation procedures.

Appendix A to Part 531—Example of Calculating Compliance Under § 531.5(c)

Authority: 49 U.S.C. 32902; delegation of authority at 49 CFR 1.95.

§ 531.1 Scope.

This part establishes average fuel economy standards pursuant to section 502(a) and (c) of the Motor Vehicle Information and Cost Savings Act, as amended, for passenger automobiles.

§ 531.2 Purpose.

The purpose of this part is to increase the fuel economy of passenger automobiles by establishing minimum levels of average fuel economy for those vehicles.

§ 531.3 Applicability.

This part applies to manufacturers of passenger automobiles.

¹³⁵¹ This information is forwarded to OMB with the ICR.

¹³⁵⁰ 15 U.S.C. 272.

§ 531.4 Definitions.

(a) *Statutory terms.* (1) The terms *average fuel economy, manufacture, manufacturer, and model year* are used as defined in section 501 of the Act.

(2) The terms *automobile and passenger automobile* are used as defined in section 501 of the Act and in accordance with the determination in part 523 of this chapter.

(b) *Other terms.* As used in this part, unless otherwise required by the context—

(1) *Act* means the Motor Vehicle Information and Cost Savings Act, as amended by Public Law 94–163.

(2) [Reserved]

§ 531.5 Fuel economy standards.

(a) Except as provided in paragraph (f) of this section, each manufacturer of passenger automobiles shall comply with the fleet average fuel economy standards in Table 1 to this paragraph (a), expressed in miles per gallon, in the model year specified as applicable:

TABLE 1 TO § 531.5(a)

Model year	Average fuel economy standard (miles per gallon)
1978	18.0
1979	19.0
1980	20.0
1981	22.0
1982	24.0
1983	26.0

TABLE 1 TO § 531.5(a)—Continued

Model year	Average fuel economy standard (miles per gallon)
1984	27.0
1985	27.5
1986	26.0
1987	26.0
1988	26.0
1989	26.5
1990–2010	27.5

(b) For model year 2011, a manufacturer's passenger automobile fleet shall comply with the fleet average fuel economy level calculated for that model year according to Figure 1 to this paragraph (b) and the appropriate values in Table 2 to this paragraph (b).

Figure 1 to § 531.5(b)

$$Required_Fuel_Economy_Level = \frac{N}{\sum_i \frac{N_i}{T_i}}$$

Where:

N is the total number (sum) of passenger automobiles produced by a manufacturer;

N_i is the number (sum) of the i th passenger automobile model produced by the manufacturer; and

T_i is the fuel economy target of the i th model passenger automobile, which is

determined according to the following formula, rounded to the nearest hundredth:

$$\frac{1}{\frac{1}{a} + \left(\frac{1}{b} - \frac{1}{a}\right) \frac{e^{(x-c)d}}{1 + e^{(x-c)d}}}$$

Where:

Parameters a , b , c , and d are defined in Table 2 to this paragraph (b);

$e = 2.718$; and

x = footprint (in square feet, rounded to the nearest tenth) of the vehicle model.

TABLE 2 TO § 531.5(b)—PARAMETERS FOR THE PASSENGER AUTOMOBILE FUEL ECONOMY TARGETS

Model year	Parameters			
	a (mpg)	b (mpg)	c (gal/mi/ft ²)	d (gal/mi)
2011	31.20	24.00	51.41	1.91

(c) For model years 2012–2026, a manufacturer's passenger automobile fleet shall comply with the fleet average

fuel economy level calculated for that model year (MY) according to Figure 2

to this paragraph (c) and the appropriate values in Table 3 to this paragraph (c).

Figure 2 to § 531.5(c)

$$CAFE_{required} = \frac{\sum_i PRODUCTION_i}{\sum_i \frac{PRODUCTION_i}{TARGET_i}}$$

Where:

$CAFE_{required}$ is the fleet average fuel economy standard for a given fleet (domestic passenger automobiles or import passenger automobiles);

Subscript i is a designation of multiple groups of automobiles, where each group's designation, *i.e.*, $i = 1, 2, 3$, etc.,

represents automobiles that share a unique model type and footprint within the applicable fleet, either domestic passenger automobiles or import passenger automobiles;

$Production_i$ is the number of passenger automobiles produced for sale in the United States within each i th

designation, *i.e.*, which share the same model type and footprint; and $TARGET_i$ is the fuel economy target in miles per gallon (mpg) applicable to the footprint of passenger automobiles within each i th designation, *i.e.*, which share the same model type and footprint, calculated according to Figure 3 to this

paragraph (c) and rounded to the nearest hundredth of a mpg, *i.e.*, 35.455 = 35.46

mpg, and the summations in the numerator and denominator are both

performed over all models in the fleet in question.

Figure 3 to § 531.5(c)

$$TARGET = \frac{1}{MIN \left[MAX \left(c \times FOOTPRINT + d, \frac{1}{a} \right), \frac{1}{b} \right]}$$

Where: *TARGET* is the fuel economy target (in mpg) applicable to vehicles of a given footprint (*FOOTPRINT*, in square feet);

Parameters *a*, *b*, *c*, and *d* are defined in Table 3 to this paragraph (c); and

The *MIN* and *MAX* functions take the minimum and maximum, respectively, of the included values.

TABLE 3 TO § 531.5(c)—PARAMETERS FOR THE PASSENGER AUTOMOBILE FUEL ECONOMY TARGETS [MYs 2012–2026]

Model year	Parameters			
	<i>a</i> (mpg)	<i>b</i> (mpg)	<i>c</i> (gal/mi/ft ²)	<i>d</i> (gal/mi)
2012	35.95	27.95	0.0005308	0.006057
2013	36.80	28.46	0.0005308	0.005410
2014	37.75	29.03	0.0005308	0.004725
2015	39.24	29.90	0.0005308	0.003719
2016	41.09	30.96	0.0005308	0.002573
2017	43.61	32.65	0.0005131	0.001896
2018	45.21	33.84	0.0004954	0.001811
2019	46.87	35.07	0.0004783	0.001729
2020	48.74	36.47	0.0004603	0.001643
2021	49.48	37.02	0.000453	0.00162
2022	50.24	37.59	0.000447	0.00159
2023	51.00	38.16	0.000440	0.00157
2024	55.44	41.48	0.000405	0.00144
2025	60.26	45.08	0.000372	0.00133
2026	66.95	50.09	0.000335	0.00120

(d) In addition to the requirements of paragraphs (b) and (c) of this section, each manufacturer shall also meet the minimum fleet standard for domestically manufactured passenger automobiles expressed in Table 4 to this paragraph (d):

TABLE 4 TO § 531.5(d)—MINIMUM FUEL ECONOMY STANDARDS FOR DOMESTICALLY MANUFACTURED PASSENGER AUTOMOBILES [MYs 2011–2026]

Model year	Minimum standard
2011	27.8
2012	30.7
2013	31.4
2014	32.1
2015	33.3
2016	34.7
2017	36.7
2018	38.0
2019	39.4
2020	40.9
2021	39.9

TABLE 4 TO § 531.5(d)—MINIMUM FUEL ECONOMY STANDARDS FOR DOMESTICALLY MANUFACTURED PASSENGER AUTOMOBILES—Continued

[MYs 2011–2026]	
Model year	Minimum standard
2022	40.6
2023	41.1
2024	44.3
2025	48.1
2026	53.5

(e) The following manufacturers shall comply with the standards indicated in paragraphs (e)(1) through (15) of this section for the specified model years:

- (1) *Avanti Motor Corporation.*

TABLE 5 TO § 531.5(e)(1)—AVERAGE FUEL ECONOMY STANDARDS

Model year	Miles per gallon
1978	16.1
1979	14.5
1980	15.8
1981	18.2
1982	18.2
1983	16.9
1984	16.9
1985	16.9

- (2) *Rolls-Royce Motors, Inc.*

TABLE 6 TO § 531.5(e)(2)—AVERAGE FUEL ECONOMY STANDARDS

Model year	Miles per gallon
1978	10.7
1979	10.8
1980	11.1
1981	10.7
1982	10.6
1983	9.9

TABLE 6 TO § 531.5(e)(2)—AVERAGE FUEL ECONOMY STANDARDS—Continued

Model year	Miles per gallon
1984	10.0
1985	10.0
1986	11.0
1987	11.2
1988	11.2
1989	11.2
1990	12.7
1991	12.7
1992	13.8
1993	13.8
1994	13.8
1995	14.6
1996	14.6
1997	15.1
1998	16.3
1999	16.3

(3) *Checker Motors Corporation.*

TABLE 7 TO § 531.5(e)(3)—AVERAGE FUEL ECONOMY STANDARDS

Model year	Miles per gallon
1978	17.6
1979	16.5
1980	18.5
1981	18.3
1982	18.4

(4) *Aston Martin Lagonda, Inc.*

TABLE 8 TO § 531.5(e)(4)—AVERAGE FUEL ECONOMY STANDARDS

Model year	Miles per gallon
1979	11.5
1980	12.1
1981	12.2
1982	12.2
1983	11.3
1984	11.3
1985	11.4

(5) *Excalibur Automobile Corporation.*

TABLE 9 TO § 531.5(e)(5)—AVERAGE FUEL ECONOMY STANDARDS

Model year	Miles per gallon
1978	11.5
1979	11.5
1980	16.2
1981	17.9
1982	17.9
1983	16.6
1984	16.6
1985	16.6

(6) *Lotus Cars Ltd.*

TABLE 10 TO § 531.5(e)(6)—AVERAGE FUEL ECONOMY STANDARDS

Model year	Miles per gallon
1994	24.2
1995	23.3

(7) *Officine Alfieri Maserati, S.p.A.*

TABLE 11 TO § 531.5(e)(7)—AVERAGE FUEL ECONOMY STANDARD

Model year	Miles per gallon
1978	12.5
1979	12.5
1980	9.5
1984	17.9
1985	16.8

(8) *Lamborghini of North America.*

TABLE 12 TO § 531.5(e)(8)—AVERAGE FUEL ECONOMY STANDARD

Model year	Miles per gallon
1983	13.7
1984	13.7

(9) *LondonCoach Co., Inc.*

TABLE 13 TO § 531.5(e)(9)—AVERAGE FUEL ECONOMY STANDARD

Model year	Miles per gallon
1985	21.0
1986	21.0
1987	21.0

(10) *Automobili Lamborghini S.p.A./ Vector Aeromotive Corporation.*

TABLE 14 § 531.5(e)(10)—AVERAGE FUEL ECONOMY STANDARD

Model year	Miles per gallon
1995	12.8
1996	12.6
1997	12.5

(11) *Dutcher Motors, Inc.*

TABLE 15 TO § 531.5(e)(11)—AVERAGE FUEL ECONOMY STANDARD

Model year	Miles per gallon
1986	16.0
1987	16.0
1988	16.0
1992	17.0
1993	17.0
1994	17.0

TABLE 15 TO § 531.5(e)(11)—AVERAGE FUEL ECONOMY STANDARD—Continued

Model year	Miles per gallon
1995	17.0

(12) *MedNet, Inc.*

TABLE 16 TO § 531.5(e)(12)—AVERAGE FUEL ECONOMY STANDARD

Model year	Average fuel economy standard (miles per gallon)
1996	17.0
1997	17.0
1998	17.0

(13) *Vector Aeromotive Corporation.*

TABLE 17 TO § 531.5(e)(13)—AVERAGE FUEL ECONOMY STANDARD

Model year	Miles per gallon
1998	12.1

(14) *Qvale Automotive Group Srl.*

TABLE 18 TO § 531.5(e)(14)—AVERAGE FUEL ECONOMY STANDARD

Model year	Miles per gallon
2000	22.0
2001	22.0

(15) *Spyker Automobielen B.V.*

TABLE 19 TO § 531.5(e)(15)—AVERAGE FUEL ECONOMY STANDARD

Model year	Miles per gallon
2006	18.9
2007	18.9

§ 531.6 Measurement and calculation procedures.

(a) The fleet average fuel economy performance of all passenger automobiles that are manufactured by a manufacturer in a model year shall be determined in accordance with procedures established by the Administrator of the Environmental Protection Agency (EPA) under 49 U.S.C. 32904 and set forth in 40 CFR part 600.

(b) For model years 2017 and later, a manufacturer is eligible to increase the fuel economy performance of passenger

cars in accordance with procedures established by the EPA set forth in 40 CFR part 600, subpart F, including any adjustments to fuel economy the EPA allows, such as for fuel consumption improvements related to air conditioning efficiency and off-cycle technologies. Manufacturers must provide reporting on these technologies as specified in § 537.7 of this chapter by the required deadlines.

(1) *Efficient air conditioning technologies.* A manufacturer that seeks to increase its fleet average fuel economy performance through the use of technologies that improve the efficiency of air conditioning systems must follow the requirements in 40 CFR 86.1868–12. Fuel consumption improvement values resulting from the use of those air conditioning systems must be determined in accordance with 40 CFR 600.510–12(c)(3)(i).

(2) *Off-cycle technologies on EPA’s predefined list or using 5-cycle testing.* A manufacturer that seeks to increase its fleet average fuel economy performance through the use of off-cycle technologies must follow the requirements in 40 CFR 86.1869–12. A manufacturer is eligible to gain fuel consumption improvements for predefined off-cycle technologies in accordance with 40 CFR 86.1869–12(b) or for technologies tested using the EPA’s 5-cycle methodology in accordance with 40 CFR 86.1869–12(c). The fuel consumption improvement is determined in accordance with 40 CFR 600.510–12(c)(3)(ii).

(3) *Off-cycle technologies using the alternative EPA-approved methodology.* A manufacturer is eligible to increase its fuel economy performance through use of an off-cycle technology requiring an application request made to the EPA in accordance with 40 CFR 86.1869–12(d).

(i) *Eligibility under the corporate average fuel economy (CAFE) program requires compliance with paragraphs (b)(3)(i)(A) through (C) of this section.* Paragraphs (b)(3)(i)(A), (B), and (D) of this section apply starting in model year 2024.

(A) A manufacturer seeking to increase its fuel economy performance using the alternative methodology for an

off-cycle technology, if prior to the applicable model year, the manufacturer submits to EPA a detailed analytical plan and is approved (i.e., for its planned test procedure and model types for demonstration) in accordance with 40 CFR 86.1869–12(d).

(B) A manufacturer seeking to increase its CAFE program fuel economy performance using the alternative methodology for an off-cycle technology must also submit an official credit application to EPA and obtain approval in accordance with 40 CFR 86.1869–12(e) prior to September of the given model year.

(C) A manufacturer’s plans, applications and requests approved by the EPA must be made in consultation with the National Highway Traffic Safety Administration (NHTSA). To expedite NHTSA’s consultation with the EPA, a manufacturer must concurrently submit its application to NHTSA if the manufacturer is seeking off-cycle fuel economy improvement values under the CAFE program for those technologies. For off-cycle technologies that are covered under 40 CFR 86.1869–12(d), NHTSA will consult with the EPA regarding NHTSA’s evaluation of the specific off-cycle technology to ensure its impact on fuel economy and the suitability of using the off-cycle technology to adjust the fuel economy performance.

(D) A manufacturer may request an extension from NHTSA for more time to obtain an EPA approval. Manufacturers should submit their requests 30 days before the deadlines in paragraphs (b)(3)(i)(A) through (C) of this section. Requests should be submitted to NHTSA’s Director of the Office of Vehicle Safety Compliance at *cafe@dot.gov*.

(ii) *Review and approval process.* NHTSA will provide to EPA its views on the suitability of using the off-cycle technology to adjust vehicle fuel economy performance. NHTSA’s evaluation and review will consider:

(A) Whether the technology has a direct impact upon improving fuel economy performance;

(B) Whether the technology is related to crash-avoidance technologies, safety critical systems or systems affecting safety-critical functions, or technologies designed for the purpose of reducing the frequency of vehicle crashes;

(C) Information from any assessments conducted by the EPA related to the application, the technology and/or related technologies; and

(D) Any other relevant factors.

(iii) *Safety.* (A) Technologies found to be defective or non-compliant, subject to recall pursuant to part 573 of this chapter, due to a risk to motor vehicle safety, will have the values of approved off-cycle credits removed from the manufacturer’s credit balance or adjusted to the population of vehicles the manufacturer remedies as required by 49 U.S.C. Chapter 301. NHTSA will consult with the manufacturer to determine the amount of the adjustment.

(B) Approval granted for innovative and off-cycle technology credits under NHTSA’s fuel efficiency program does not affect or relieve the obligation to comply with the Vehicle Safety Act (49 U.S.C. Chapter 301), including the “make inoperative” prohibition (49 U.S.C. 30122), and all applicable Federal motor vehicle safety standards (FMVSSs) issued thereunder (part 571 of this chapter). In order to generate off-cycle or innovative technology credits manufacturers must state—

(1) That each vehicle equipped with the technology for which they are seeking credits will comply with all applicable FMVSS(s); and

(2) Whether or not the technology has a fail-safe provision. If no fail-safe provision exists, the manufacturer must explain why not and whether a failure of the innovative technology would affect the safety of the vehicle.

Appendix A to Part 531—Example of Calculating Compliance Under § 531.5(c)

Assume a hypothetical manufacturer (Manufacturer X) produces a fleet of domestic passenger automobiles in MY 2012 as follows:

APPENDIX A—TABLE I

Model type		Basic engine (L)	Transmission class	Description	Actual measured fuel economy (mpg)	Volume
Group	Carline name					
1	PC A FWD	1.8	A5	2-door sedan	34.0	1,500
2	PC A FWD	1.8	M6	2-door sedan	34.6	2,000
3	PC A FWD	2.5	A6	4-door wagon	33.8	2,000
4	PC A AWD	1.8	A6	4-door wagon	34.4	1,000
5	PC A AWD	2.5	M6	2-door hatchback	32.9	3,000
6	PC B RWD	2.5	A6	4-door wagon	32.2	8,000

APPENDIX A—TABLE I—Continued

Model type				Description	Actual measured fuel economy (mpg)	Volume
Group	Carline name	Basic engine (L)	Transmission class			
7	PC B RWD	2.5	A7	4-door sedan	33.1	2,000
8	PC C AWD	3.2	A7	4-door sedan	30.6	5,000
9	PC C FWD	3.2	M6	2-door coupe	28.5	3,000
Total						27,500

Note to Table I to this appendix: Manufacturer X's required fleet average fuel economy standard level would first be calculated by determining the fuel economy targets applicable to each unique model type and footprint combination for model type groups 1–9 as illustrated in Table II to this appendix.

Manufacturer X calculates a fuel economy target standard for each unique model type and footprint combination.

APPENDIX A—TABLE II

Model type				Description	Base tire size	Wheel-base (inches)	Track width F&R average (inches)	Footprint (ft²)	Volume	Fuel economy target standard (mpg)
Group	Carline name	Basic engine (L)	Transmission class							
1	PC A FWD	1.8	A5	2-door sedan	205/75R14	99.8	61.2	42.4	1,500	35.01
2	PC A FWD	1.8	M6	2-door sedan	215/70R15	99.8	60.9	42.2	2,000	35.14
3	PC A FWD	2.5	A6	4-door wagon	215/70R15	100.0	60.9	42.3	2,000	35.08
4	PC A AWD	1.8	A6	4-door wagon	235/60R15	100.0	61.2	42.5	1,000	35.95
5	PC A AWD	2.5	M6	2-door hatchback	225/65R16	99.6	59.5	41.2	3,000	35.81
6	PC B RWD	2.5	A6	4-door wagon	265/55R18	109.2	66.8	50.7	8,000	30.33
7	PC B RWD	2.5	A7	4-door sedan	235/65R17	109.2	67.8	51.4	2,000	29.99
8	PC C AWD	3.2	A7	4-door sedan	265/55R18	111.3	67.8	52.4	5,000	29.52
9	PC C FWD	3.2	M6	2-door coupe	225/65R16	111.3	67.2	51.9	3,000	29.76
Total									27,500	

Note to Table II to this appendix: With the appropriate fuel economy targets determined for each unique model type and footprint combination, Manufacturer X's required fleet average fuel economy standard would be calculated as illustrated in Figure 1 to this appendix.

BILLING CODE 4910–59–P

Appendix A Figure 1—Calculation of Manufacturer X's fleet average fuel economy standard using Table II

Fleet Average Fuel Economy Standard

$$= \frac{\text{(Manufacturer's Domestic Passenger Automobile Production for Applicable Model Year)}}{\sum_i \left(\frac{\text{Group}_1 \text{ Production}}{\text{Group}_1 \text{ Target Standard}} + \frac{\text{Group}_2 \text{ Production}}{\text{Group}_{12a} \text{ Target Standard}} + \dots + \frac{\text{Group}_9 \text{ Production}}{\text{Group}_9 \text{ Target Standard}} \right)}$$

Fleet Average Fuel Economy Standard

$$= \frac{(27,500)}{\left(\frac{1500}{35.01} + \frac{2000}{35.14} + \frac{2000}{35.08} + \frac{1000}{35.95} + \frac{3000}{35.81} + \frac{8000}{30.33} + \frac{2000}{29.99} + \frac{5000}{29.52} + \frac{3000}{29.79} \right)}$$

= 31.6mpg

Appendix A Figure 2—Calculation of Manufacturer X's actual fleet average fuel economy performance level using Table I

Fleet Average Fuel Economy Performance

$$= \frac{(\text{Manufacturer's Domestic Passenger Automobile Production for Applicable Model Year})}{\sum_i \left(\frac{\text{Group}_1 \text{ Production}}{\text{Group}_1 \text{ Performance}} + \frac{\text{Group}_2 \text{ Production}}{\text{Group}_2 \text{ Performance}} + \dots + \frac{\text{Group}_9 \text{ Production}}{\text{Group}_9 \text{ Performance}} \right)}$$

Fleet Average Fuel Economy Performance

$$= \frac{(27,500)}{\left(\frac{1500}{34.0} + \frac{2000}{34.6} + \frac{2000}{33.8} + \frac{1000}{34.4} + \frac{3000}{32.9} + \frac{8000}{32.2} + \frac{2000}{33.1} + \frac{5000}{30.6} + \frac{3000}{28.5} \right)} = 32.0 \text{ mpg}$$

BILLING CODE 4910-59-C

Note to Figure 2 to this appendix: Since the actual fleet average fuel economy performance of Manufacturer X's fleet is 32.0 mpg, as compared to its required fleet fuel economy standard of 31.6 mpg, Manufacturer X complied with the CAFE standard for MY 2012 as set forth in § 531.5(c).

■ 2. Revise part 533 to read as follows:

PART 533—LIGHT TRUCK FUEL ECONOMY STANDARDS

Sec.

533.1 Scope.

533.2 Purpose.

533.3 Applicability.

533.4 Definitions.

533.5 Requirements.

533.6 Measurement and calculation procedures.

Appendix A to Part 533—Example of Calculating Compliance Under § 533.5(i)

Authority: 49 U.S.C. 32902; delegation of authority at 49 CFR 1.95.

§ 533.1 Scope.

This part establishes average fuel economy standards pursuant to section 502(b) of the Motor Vehicle Information and Cost Savings Act, as amended, for light trucks.

§ 533.2 Purpose.

The purpose of this part is to increase the fuel economy of light trucks by establishing minimum levels of average fuel economy for those vehicles.

§ 533.3 Applicability.

This part applies to manufacturers of light trucks.

§ 533.4 Definitions.

(a) *Statutory terms.* (1) The terms *average fuel economy*, *average fuel economy standard*, *fuel economy*, *import*, *manufacture*, *manufacturer*, and *model year* are used as defined in section 501 of the Act.

(2) The term *automobile* is used as defined in section 501 of the Act and in accordance with the determinations in part 523 of this chapter.

(3) The term *domestically manufactured* is used as defined in section 503(b)(2)(E) of the Act.

(b) *Other terms.* As used in this part, unless otherwise required by the context—

(1) *Act* means the Motor Vehicle Information Cost Savings Act, as amended by Public Law 94-163.

(2) *Light truck* is used in accordance with the determinations in part 523 of this chapter.

(3) *Captive import* means with respect to a light truck, one which is not

domestically manufactured but which is imported in the 1980 model year or thereafter by a manufacturer whose principal place of business is in the United States.

(4) *4-wheel drive general utility vehicle* means a 4-wheel drive, general purpose automobile capable of off-highway operation that has a wheelbase of not more than 280 centimeters, and that has a body shape similar to 1977 Jeep CJ-5 or CJ-7, or the 1977 Toyota Land Cruiser.

(5) *Basic engine* means a unique combination of manufacturer, engine displacement, number of cylinders, fuel system (as distinguished by number of carburetor barrels or use of fuel injection), and catalyst usage.

(6) *Limited product line light truck* means a light truck manufactured by a manufacturer whose light truck fleet is powered exclusively by basic engines which are not also used in passenger automobiles.

§ 533.5 Requirements.

(a) Each manufacturer of light trucks shall comply with the following fleet average fuel economy standards, expressed in miles per gallon, in the model year (MY) specified as applicable:

TABLE 1 TO § 533.5(a)

Model year	2-wheel drive light trucks		4-wheel drive light trucks		Limited product line light trucks
	Captive imports	Other	Captive imports	Other	
1979	17.2	15.8
1980	16.0	16.0	14.0	14.0	14.0
1981	16.7	16.7	15.0	15.0	14.5

TABLE 2 TO § 533.5(a)

Model year	Combined standard		2-wheel drive light trucks		4-wheel drive light trucks	
	Captive imports	Others	Captive imports	Others	Captive imports	Others
1982	17.5	17.5	18.0	18.0	16.0	16.0
1983	19.0	19.0	19.5	19.5	17.5	17.5
1984	20.0	20.0	20.3	20.3	18.5	18.5
1985	19.5	19.5	19.7	19.7	18.9	18.9
1986	20.0	20.0	20.5	20.5	19.5	19.5
1987	20.5	20.5	21.0	21.0	19.5	19.5
1988	20.5	20.5	21.0	21.0	19.5	19.5
1989	20.5	20.5	21.5	21.5	19.0	19.0
1990	20.0	20.0	20.5	20.5	19.0	19.0
1991	20.2	20.2	20.7	20.7	19.1	19.1

TABLE 3 TO § 533.5(a)

Model year	Combined standard	
	Captive imports	Other
1992	20.2	20.2
1993	20.4	20.4
1994	20.5	20.5
1995	20.6	20.6

TABLE 4 TO § 533.5(a)

Model year	Standard
2001	20.7
2002	20.7
2003	20.7
2004	20.7
2005	21.0
2006	21.6
2007	22.2

TABLE 4 TO § 533.5(a)—Continued

Model year	Standard
2008	22.5
2009	23.1
2010	23.5

Figure 1 to § 533.5(a)

$$Required_Fuel_Economy_Level = \frac{N}{\sum_i \frac{N_i}{T_i}}$$

Where:

N is the total number (sum) of light trucks produced by a manufacturer;

N_i is the number (sum) of the *i*th light truck model type produced by a manufacturer; and

T_i is the fuel economy target of the *i*th light truck model type, which is determined according to the following formula, rounded to the nearest hundredth:

$$T = \frac{1}{\frac{1}{a} + \left(\frac{1}{b} - \frac{1}{a}\right) \frac{e^{(x-c)d}}{1 + e^{(x-c)d}}}$$

Where:

Parameters *a*, *b*, *c*, and *d* are defined in Table 5 to this paragraph (a); *e* = 2.718; and

x = footprint (in square feet, rounded to the nearest tenth) of the model type.

TABLE 5 TO § 533.5(a)—PARAMETERS FOR THE LIGHT TRUCK FUEL ECONOMY TARGETS FOR MYS [2008–2011]

Model year	Parameters			
	<i>a</i> (mpg)	<i>b</i> (mpg)	<i>c</i> (gal/mi/ft ²)	<i>d</i> (gal/mi)
2008	28.56	19.99	49.30	5.58
2009	30.07	20.87	48.00	5.81
2010	29.96	21.20	48.49	5.50
2011	27.10	21.10	56.41	4.28

Figure 2 to § 533.5(a)

$$CAFE_{required} = \frac{\sum_i PRODUCTION_i}{\sum_i \frac{PRODUCTION_i}{TARGET_i}}$$

Where:

CAFE_{required} is the fleet average fuel economy standard for a given light truck fleet;
 Subscript *i* is a designation of multiple groups of light trucks, where each group's designation, *i.e.*, *i* = 1, 2, 3, etc., represents light trucks that share a unique model type and footprint within the applicable fleet;

Production_i is the number of light trucks produced for sale in the United States within each *i*th designation, *i.e.*, which share the same model type and footprint; and
TARGET_i is the fuel economy target in miles per gallon (mpg) applicable to the footprint of light trucks within each *i*th designation, *i.e.*, which share the same

model type and footprint, calculated according to either Figure 3 or 4 to this paragraph (a), as appropriate, and rounded to the nearest hundredth of a mpg, *i.e.*, 35.455 = 35.46 mpg, and the summations in the numerator and denominator are both performed over all models in the fleet in question.

Figure 3 to § 533.5(a)

$$TARGET = \frac{1}{MIN \left[MAX \left(c \times FOOTPRINT + d, \frac{1}{a} \right), \frac{1}{b} \right]}$$

Where:

TARGET is the fuel economy target (in mpg) applicable to vehicles of a given footprint (*FOOTPRINT*, in square feet);

Parameters *a*, *b*, *c*, and *d* are defined in Table 6 to this paragraph (a); and

The *MIN* and *MAX* functions take the minimum and maximum, respectively, of the included values.

TABLE 6 FOR § 533.5(a)—PARAMETERS FOR THE LIGHT TRUCK FUEL ECONOMY TARGETS FOR MYS [2012–2016]

Model year	Parameters			
	<i>a</i> (mpg)	<i>b</i> (mpg)	<i>c</i> (gal/mi/ft ²)	<i>d</i> (gal/mi)
2012	29.82	22.27	0.0004546	0.014900
2013	30.67	22.74	0.0004546	0.013968
2014	31.38	23.13	0.0004546	0.013225
2015	32.72	23.85	0.0004546	0.011920
2016	34.42	24.74	0.0004546	0.010413

Figure 4 to § 533.5(a)

TARGET

$$= MAX \left(\frac{1}{MIN \left[MAX \left(c \times FOOTPRINT + d, \frac{1}{a} \right), \frac{1}{b} \right]}, \frac{1}{MIN \left[MAX \left(g \times FOOTPRINT + h \frac{1}{e} \right), \frac{1}{f} \right]} \right)$$

Where:

TARGET is the fuel economy target (in mpg) applicable to vehicles of a given footprint (FOOTPRINT, in square feet);

Parameters a, b, c, d, e, f, g, and h are defined in Table 7 to this paragraph (a); and

The MIN and MAX functions take the minimum and maximum, respectively, of the included values.

TABLE 7 TO § 533.5(a)—PARAMETERS FOR THE LIGHT TRUCK FUEL ECONOMY TARGETS FOR MYs [2017–2026]

Model year	Parameters							
	a (mpg)	b (mpg)	c (gal/mi/ft ²)	d (gal/mi)	e (mpg)	f (mpg)	g (gal/mi/ft ²)	h (gal/mi)
2017	36.26	25.09	0.0005484	0.005097	35.10	25.09	0.0004546	0.009851
2018	37.36	25.20	0.0005358	0.004797	35.31	25.20	0.0004546	0.009682
2019	38.16	25.25	0.0005265	0.004623	35.41	25.25	0.0004546	0.009603
2020	39.11	25.25	0.0005140	0.004494	35.41	25.25	0.0004546	0.009603
2021	39.71	25.63	0.000506	0.00443	NA	NA	NA	NA
2022	40.31	26.02	0.000499	0.00436	NA	NA	NA	NA
2023	40.93	26.42	0.000491	0.00429	NA	NA	NA	NA
2024	44.48	26.74	0.000452	0.00395	NA	NA	NA	NA
2025	48.35	29.07	0.000416	0.00364	NA	NA	NA	NA
2026	53.73	32.30	0.000374	0.00327	NA	NA	NA	NA

(b)(1) For model year 1979, each manufacturer may:

(i) Combine its 2- and 4-wheel drive light trucks and comply with the average fuel economy standard in paragraph (a) of this section for 2-wheel drive light trucks; or

(ii) Comply separately with the two standards specified in paragraph (a) of this section.

(2) For model year 1979, the standard specified in paragraph (a) of this section for 4-wheel drive light trucks applies only to 4-wheel drive general utility vehicles. All other 4-wheel drive light trucks in that model year shall be included in the 2-wheel drive category for compliance purposes.

(c) For model years 1980 and 1981, manufacturers of limited product line light trucks may:

(1) Comply with the separate standard for limited product line light trucks in Table 1 to paragraph (a) of this section; or

(2) Comply with the other standards specified in paragraph (a) of this section, as applicable.

(d) For model years 1982–91, each manufacturer may:

(1) Combine its 2- and 4-wheel drive light trucks (segregating captive import and other light trucks) and comply with the combined average fuel economy standard specified in paragraph (a) of this section; or

(2) Comply separately with the 2-wheel drive standards and the 4-wheel drive standards (segregating captive import and other light trucks) specified in paragraph (a) of this section.

(e) For model year 1992, each manufacturer shall comply with the average fuel economy standard specified in paragraph (a) of this section (segregating captive import and other light trucks).

(f) For each model year 1996 and thereafter, each manufacturer shall combine its captive imports with its other light trucks and comply with the fleet average fuel economy standard in paragraph (a) of this section.

(g) For model years 2008–2010, at a manufacturer's option, a manufacturer's light truck fleet may comply with the fuel economy standard calculated for each model year according to Figure 1 to paragraph (a) of this section and the appropriate values in Table 5 to

paragraph (a) of this section, with said option being irrevocably chosen for that model year and reported as specified in § 537.8 of this chapter.

(h) For model year 2011, a manufacturer's light truck fleet shall comply with the fleet average fuel economy standard calculated for that model year according to Figure 1 to paragraph (a) of this section and the appropriate values in Table 5 to paragraph (a) of this section.

(i) For model years 2012–2016, a manufacturer's light truck fleet shall comply with the fleet average fuel economy standard calculated for that model year according to Figures 2 and 3 to paragraph (a) of this section and the appropriate values in Table 6 to paragraph (a) of this section.

(j) For model years 2017–2026, a manufacturer's light truck fleet shall comply with the fleet average fuel economy standard calculated for that model year according to Figures 2 and 4 to paragraph (a) of this section and the appropriate values in Table 7 to paragraph (a) of this section.

§ 533.6 Measurement and calculation procedures.

(a) Any reference to a class of light trucks manufactured by a manufacturer shall be deemed—

(1) To include all light trucks in that class manufactured by persons who control, are controlled by, or are under common control with, such manufacturer;

(2) To include only light trucks which qualify as non-passenger vehicles in accordance with § 523.5 of this chapter based upon the production measurements of the vehicles as sold to dealerships; and

(3) To exclude all light trucks in that class manufactured (within the meaning of paragraph (a)(1) of this section) during a model year by such manufacturer which are exported prior to the expiration of 30 days following the end of such model year.

(b) The fleet average fuel economy performance of all light trucks that are manufactured by a manufacturer in a model year shall be determined in accordance with procedures established by the Administrator of the Environmental Protection Agency (EPA) under 49 U.S.C. 32904 and set forth in 40 CFR part 600.

(c) For model years 2017 and later, a manufacturer is eligible to increase the fuel economy performance of light trucks in accordance with procedures established by the EPA set forth in 40 CFR part 600, subpart F, including any adjustments to fuel economy the EPA allows, such as for fuel consumption improvements related to air conditioning efficiency, off-cycle technologies, and hybridization and other performance-based technologies for full-size pickup trucks that meet the requirements specified in 40 CFR 86.1803. Manufacturers must provide reporting on these technologies as specified in § 537.7 of this chapter by the required deadlines.

(1) *Efficient air conditioning technologies.* A manufacturer that seeks to increase its fleet average fuel economy performance through the use of technologies that improve the efficiency of air conditioning systems must follow the requirements in 40 CFR 86.1868–12. Fuel consumption improvement values resulting from the use of those air conditioning systems must be determined in accordance with 40 CFR 600.510–12(c)(3)(i).

(2) *Incentives for advanced full-size light-duty pickup trucks.* For model year 2023 and 2024, the eligibility of a manufacturer to increase its fuel economy using hybridized and other performance-based technologies for full-size pickup trucks must follow 40 CFR

86.1870–12 and the fuel consumption improvement of these full-size pickup truck technologies must be determined in accordance with 40 CFR 600.510–12(c)(3)(iii). Manufacturers may also combine incentives for full size pickups and dedicated alternative fueled vehicles when calculating fuel economy performance values in 40 CFR 600.510–12.

(3) *Off-cycle technologies on EPA's predefined list or using 5-cycle testing.* A manufacturer that seeks to increase its fleet average fuel economy performance through the use of off-cycle technologies must follow the requirements in 40 CFR 86.1869–12. A manufacturer is eligible to gain fuel consumption improvements for predefined off-cycle technologies in accordance with 40 CFR 86.1869–12(b) or for technologies tested using the EPA's 5-cycle methodology in accordance with 40 CFR 86.1869–12(c). The fuel consumption improvement is determined in accordance with 40 CFR 600.510–12(c)(3)(ii).

(4) *Off-cycle technologies using the alternative EPA-approved methodology.* A manufacturer is eligible to increase its fuel economy performance through use of an off-cycle technology requiring an application request made to the EPA in accordance with 40 CFR 86.1869–12(d).

(i) *Eligibility under the corporate average fuel economy (CAFE) program requires compliance with paragraphs (c)(4)(i)(A) through (C) of this section.* Paragraphs (c)(4)(i)(A), (B), and (D) of this section apply starting in model year 2024.

(A) A manufacturer seeking to increase its fuel economy performance using the alternative methodology for an off-cycle technology, if prior to the applicable model year, the manufacturer submits to EPA a detailed analytical plan and is approved (*i.e.*, for its planned test procedure and model types for demonstration) in accordance with 40 CFR 86.1869–12(d).

(B) A manufacturer seeking to increase its fuel economy performance using the alternative methodology for an off-cycle technology must also submit an official credit application to EPA and obtain approval in accordance with 40 CFR 86.1869–12(e) prior to September of the given model year.

(C) A manufacturer's plans, applications and requests approved by the EPA must be made in consultation with the National Highway Traffic Safety Administration (NHTSA). To expedite NHTSA's consultation with the EPA, a manufacturer must concurrently submit its application to NHTSA if the manufacturer is seeking off-cycle fuel economy improvement values under the CAFE program for those technologies.

For off-cycle technologies that are covered under 40 CFR 86.1869–12(d), NHTSA will consult with the EPA regarding NHTSA's evaluation of the specific off-cycle technology to ensure its impact on fuel economy and the suitability of using the off-cycle technology to adjust the fuel economy performance.

(D) A manufacturer may request an extension from NHTSA for more time to obtain an EPA approval. Manufacturers should submit their requests 30 days before the deadlines in paragraphs (c)(4)(i)(A) through (C) of this section. Requests should be submitted to NHTSA's Director of the Office of Vehicle Safety Compliance at cafe@dot.gov.

(ii) *Review and approval process.* NHTSA will provide to EPA its views on the suitability of using the off-cycle technology to adjust vehicle fuel economy performance. NHTSA's evaluation and review will consider:

(A) Whether the technology has a direct impact upon improving fuel economy performance;

(B) Whether the technology is related to crash-avoidance technologies, safety critical systems or systems affecting safety-critical functions, or technologies designed for the purpose of reducing the frequency of vehicle crashes;

(C) Information from any assessments conducted by the EPA related to the application, the technology and/or related technologies; and

(D) Any other relevant factors.

(E) NHTSA will collaborate to host annual meetings with EPA at least once by July 30th before the model year begins to provide general guidance to the industry on past off-cycle approvals.

(iii) *Safety.* (A) Technologies found to be defective or non-compliant, subject to recall pursuant to part 573 of this chapter, due to a risk to motor vehicle safety, will have the values of approved off-cycle credits removed from the manufacturer's credit balance or adjusted to the population of vehicles the manufacturer remedies as required by 49 U.S.C. Chapter 301. NHTSA will consult with the manufacturer to determine the amount of the adjustment.

(B) Approval granted for innovative and off-cycle technology credits under NHTSA's fuel efficiency program does not affect or relieve the obligation to comply with the Vehicle Safety Act (49 U.S.C. Chapter 301), including the "make inoperative" prohibition (49 U.S.C. 30122), and all applicable Federal motor vehicle safety standards issued thereunder (FMVSSs) (part 571 of this chapter). In order to generate off-

cycle or innovative technology credits manufacturers must state—

(1) That each vehicle equipped with the technology for which they are seeking credits will comply with all applicable FMVSS(s); and

(2) Whether or not the technology has a fail-safe provision. If no fail-safe provision exists, the manufacturer must explain why not and whether a failure of the innovative technology would affect the safety of the vehicle.

Appendix A to Part 533—Example of Calculating Compliance Under § 533.5(i)

Assume a hypothetical manufacturer (Manufacturer X) produces a fleet of light trucks in MY 2012 as follows:

APPENDIX A—TABLE I

Model type				Description	Actual measured fuel economy (mpg)	Volume
Group	Carline name	Basic engine (L)	Transmission class			
1	Pickup A 2WD	4	A5	Reg cab, MB	27.1	800
2	Pickup B 2WD	4	M5	Reg cab, MB	27.6	200
3	Pickup C 2WD	4.5	A5	Reg cab, LB	23.9	300
4	Pickup C 2WD	4	M5	Ext cab, MB	23.7	400
5	Pickup C 4WD	4.5	A5	Crew cab, SB	23.5	400
6	Pickup D 2WD	4.5	A6	Crew cab, SB	23.6	400
7	Pickup E 2WD	5	A6	Ext cab, LB	22.7	500
8	Pickup E 2WD	5	A6	Crew cab, MB	22.5	500
9	Pickup F 2WD	4.5	A5	Reg cab, LB	22.5	1,600
10	Pickup F 4WD	4.5	A5	Ext cab, MB	22.3	800
11	Pickup F 4WD	4.5	A5	Crew cab, SB	22.2	800
Total						6,700

Note to Table I to this appendix: Manufacturer X's required fleet average fuel economy standard level would first be calculated by determining the fuel economy targets applicable to each unique model type and footprint combination for model type groups 1–11 as illustrated in Table II to this appendix.

Manufacturer X calculates a fuel economy target standard for each unique model type and footprint combination.

APPENDIX A—TABLE II

Model type				Description	Base tire size	Wheel-base (inches)	Track width F&R average (inches)	Footprint (ft ²)	Volume	Fuel economy target standard (mpg)
Group	Carline name	Basic engine (L)	Transmission class							
1	Pickup A 2WD	4	A5	Reg cab, MB	235/75R15	100.0	68.8	47.8	800	27.30
2	Pickup B 2WD	4	M5	Reg cab, MB	235/75R15	100.0	68.2	47.4	200	27.44
3	Pickup C 2WD	4.5	A5	Reg cab, LB	255/70R17	125.0	68.8	59.7	300	23.79
4	Pickup C 2WD	4	M5	Ext cab, MB	255/70R17	125.0	68.8	59.7	400	23.79
5	Pickup C 4WD	4.5	A5	Crew cab, SB	275/70R17	150.0	69.0	71.9	400	22.27
6	Pickup D 2WD	4.5	A6	Crew cab, SB	255/70R17	125.0	68.8	59.7	400	23.79
7	Pickup E 2WD	5	A6	Ext cab, LB	255/70R17	125.0	68.8	59.7	500	23.79
8	Pickup E 2WD	5	A6	Crew cab, MB	285/70R17	125.0	69.2	60.1	500	23.68
9	Pickup F 2WD	4.5	A5	Reg cab, LB	255/70R17	125.0	68.9	59.8	1,600	23.76
10	Pickup F 4WD	4.5	A5	Ext cab, MB	275/70R17	150.0	69.0	71.9	800	22.27
11	Pickup F 4WD	4.5	A5	Crew cab, SB	285/70R17	150.0	69.2	72.1	800	22.27
Total									6,700	

Note to Table II to this appendix: With the appropriate fuel economy targets determined for each unique model type and footprint combination, Manufacturer X's required fleet average fuel economy standard would be calculated as illustrated in Figure 1 to this appendix:

Appendix A Figure 1—Calculation of Manufacturer X's Fleet Average Fuel

Economy Standard Using Table II

Fleet Average Fuel Economy Standard

$$= \frac{\text{(Manufacturer's light truck Production for Applicable Model Year)}}{\sum_i \left(\frac{\text{Group}_1 \text{ Production}}{\text{Group}_1 \text{ Target Standard}} + \frac{\text{Group}_{2a} \text{ Production}}{\text{Group}_2 \text{ Target Standard}} + \dots + \frac{\text{Group}_{11} \text{ Production}}{\text{Group}_{11} \text{ Target Standard}} \right)}$$

Fleet Average Fuel Economy Standard

$$= \frac{(6,700)}{\left(\frac{800}{27.30} + \frac{200}{27.44} + \frac{300}{23.79} + \frac{400}{23.79} + \frac{400}{22.27} + \frac{400}{23.79} + \frac{500}{23.79} + \frac{500}{23.68} + \frac{1600}{23.76} + \frac{800}{22.27} + \frac{800}{22.27} \right)}$$

$$= 23.7 \text{ mpg}$$

Appendix A Figure 2—Calculation of Manufacturer X's Actual Fleet Average Fuel

Economy Performance Level Using Table I

Fleet Average Fuel Economy Performance

$$= \frac{\text{(Manufacturer's Light Truck Production for Applicable Model Year)}}{\sum_i \left(\frac{\text{Group}_1 \text{ Production}}{\text{Group}_1 \text{ Performance}} + \frac{\text{Group}_2 \text{ Production}}{\text{Group}_2 \text{ Performance}} + \dots + \frac{\text{Group}_{11} \text{ Production}}{\text{Group}_{11} \text{ Performance}} \right)}$$

Fleet Average Fuel Economy Performance

$$= \frac{(6,700)}{\left(\frac{800}{27.1} + \frac{200}{27.6} + \frac{300}{23.9} + \frac{400}{23.7} + \frac{400}{23.5} + \frac{400}{23.6} + \frac{500}{22.7} + \frac{500}{22.5} + \frac{1600}{22.5} + \frac{800}{22.3} + \frac{800}{22.2} \right)}$$

$$= 23.3 \text{ mpg}$$

BILLING CODE 4910-59-C

Note to Figure 2 to this appendix: Since the actual fleet average fuel economy performance of Manufacturer X's fleet is 23.3 mpg, as compared to its required fleet fuel economy standard of 23.7 mpg, Manufacturer X did not comply with the CAFE standard for MY 2012 as set forth in § 533.5(i).

■ 3. Revise part 536 to read as follows:

PART 536—TRANSFER AND TRADING OF FUEL ECONOMY CREDITS

Sec.

- 536.1 Scope.
- 536.2 Application.
- 536.3 Definitions.
- 536.4 Credits.
- 536.5 Trading infrastructure.
- 536.6 Treatment of credits earned prior to model year 2011.
- 536.7 Treatment of carryback credits.
- 536.8 Conditions for trading of credits.

536.9 Use of credits with regard to the domestically manufactured passenger automobile minimum standard.

536.10 Treatment of dual-fuel and alternative fuel vehicles—consistency with 49 CFR part 538.

Authority: 49 U.S.C. 32903; delegation of authority at 49 CFR 1.95.

§ 536.1 Scope.

This part establishes regulations governing the use and application of corporate average fuel economy (CAFE)

credits up to three model years before and five model years after the model year in which the credit was earned. It also specifies requirements for manufacturers wishing to transfer fuel economy credits between their fleets and for manufacturers and other persons wishing to trade fuel economy credits to achieve compliance with prescribed fuel economy standards.

§ 536.2 Application.

This part applies to all credits earned (and transferable and tradable) for exceeding applicable average fuel economy standards in a given model year for domestically manufactured passenger cars, imported passenger cars, and light trucks.

§ 536.3 Definitions.

(a) *Statutory terms.* All terms defined in 49 U.S.C. 32901(a) are used pursuant to their statutory meaning.

(b) *Other terms.* (1) *Above standard fuel economy* means, with respect to a compliance category, that the automobiles manufactured by a manufacturer in that compliance category in a particular model year have greater average fuel economy (calculated in a manner that reflects the incentives for alternative fuel automobiles per 49 U.S.C. 32905) than that manufacturer's fuel economy standard for that compliance category and model year.

(2) *Adjustment factor* means a factor used to adjust the value of a traded or transferred credit for compliance purposes to ensure that the compliance value of the credit when used reflects the total volume of oil saved when the credit was earned.

(3) *Below standard fuel economy* means, with respect to a compliance category, that the automobiles manufactured by a manufacturer in that compliance category in a particular model year have lower average fuel economy (calculated in a manner that reflects the incentives for alternative fuel automobiles per 49 U.S.C. 32905) than that manufacturer's fuel economy standard for that compliance category and model year.

(4) *Compliance* means a manufacturer achieves compliance in a particular compliance category when:

(i) The average fuel economy of the vehicles in that category exceed or meet the fuel economy standard for that category; or

(ii) The average fuel economy of the vehicles in that category do not meet the fuel economy standard for that category, but the manufacturer proffers a sufficient number of valid credits, adjusted for total oil savings, to cover the gap between the average fuel

economy of the vehicles in that category and the required average fuel economy. A manufacturer achieves compliance for its fleet if the conditions in paragraph (b)(4)(i) of this section or this paragraph (b)(4)(ii) are simultaneously met for all compliance categories.

(5) *Compliance category* means any of three categories of automobiles subject to Federal fuel economy regulations in this chapter. The three compliance categories recognized by 49 U.S.C. 32903(g)(6) are domestically manufactured passenger automobiles, imported passenger automobiles, and non-passenger automobiles ("light trucks").

(6) *Credit holder (or holder)* means a legal person that has valid possession of credits, either because they are a manufacturer who has earned credits by exceeding an applicable fuel economy standard in this chapter, or because they are a designated recipient who has received credits from another holder. Credit holders need not be manufacturers, although all manufacturers may be credit holders.

(7) *Credits (or fuel economy credits)* means an earned or purchased allowance recognizing that the average fuel economy of a particular manufacturer's vehicles within a particular compliance category and model year exceeds that manufacturer's fuel economy standard for that compliance category and model year. One credit is equal to $\frac{1}{10}$ of a mile per gallon above the fuel economy standard per one vehicle within a compliance category. Credits are denominated according to model year in which they are earned (vintage), originating manufacturer, and compliance category.

(8) *Expiry date* means the model year after which fuel economy credits may no longer be used to achieve compliance with fuel economy regulations in this chapter. Expiry dates are calculated in terms of model years: For example, if a manufacturer earns credits for model year 2011, these credits may be used for compliance in model years 2008–2016.

(9) *Fleet* means all automobiles that are manufactured by a manufacturer in a particular model year and are subject to fuel economy standards under parts 531 and 533 of this chapter. For the purposes of this part, a manufacturer's fleet means all domestically manufactured and imported passenger automobiles and non-passenger automobiles ("light trucks"). "Work trucks" and medium and heavy trucks are not included in this definition for purposes of this part.

(10) *Light truck* means the same as "non-passenger automobile," as that term is defined in 49 U.S.C.

32901(a)(17), and as "light truck," as that term is defined at § 523.5 of this chapter.

(11) *Originating manufacturer* means the manufacturer that originally earned a particular credit. Each credit earned will be identified with the name of the originating manufacturer.

(12) *Trade* means the receipt by the National Highway Traffic Administration (NHTSA) of an instruction from a credit holder to place one of its credits in the account of another credit holder. A credit that has been traded can be identified because the originating manufacturer will be a different party than the current credit holder. Traded credits are moved from one credit holder to the recipient credit holder within the same compliance category for which the credits were originally earned. If a credit has been traded to another credit holder and is subsequently traded back to the originating manufacturer, it will be deemed not to have been traded for compliance purposes.

(13) *Transfer* means the application by a manufacturer of credits earned by that manufacturer in one compliance category or credits acquired by trade (and originally earned by another manufacturer in that category) to achieve compliance with fuel economy standards with respect to a different compliance category. For example, a manufacturer may purchase light truck credits from another manufacturer, and transfer them to achieve compliance in the manufacturer's domestically manufactured passenger car fleet. Subject to the credit transfer limitations of 49 U.S.C. 32903(g)(3), credits can also be transferred across compliance categories and banked or saved in that category to be carried forward or backwards later to address a credit shortfall.

(14) *Vintage* means, with respect to a credit, the model year in which the credit was earned.

§ 536.4 Credits.

(a) *Type and vintage.* All credits are identified and distinguished in the accounts by originating manufacturer, compliance category, and model year of origin (vintage).

(b) *Application of credits.* All credits earned and applied are calculated, per 49 U.S.C. 32903(c), in tenths of a mile per gallon by which the average fuel economy of vehicles in a particular compliance category manufactured by a manufacturer in the model year in which the credits are earned exceeds the applicable average fuel economy standard, multiplied by the number of vehicles sold in that compliance

category. However, credits that have been traded between credit holders or transferred between compliance categories are valued for compliance purposes using the adjustment factor specified in paragraph (c) of this section, pursuant to the “total oil savings” requirement of 49 U.S.C. 32903(f)(1).

(c) *Adjustment factor.* When traded or transferred and used, fuel economy credits are adjusted to ensure fuel oil savings is preserved. For traded credits, the user (or buyer) must multiply the calculated adjustment factor by the number of shortfall credits it plans to offset in order to determine the number of equivalent credits to acquire from the earner (or seller). For transferred credits,

the user of credits must multiply the calculated adjustment factor by the number of shortfall credits it plans to offset in order to determine the number of equivalent credits to transfer from the compliance category holding the available credits. The adjustment factor is calculated according to the following formula in figure 1 to this paragraph (c):

Figure 1 to § 536.4(c)--Formula for Calculating Adjustment Factor

$$A = \left(\frac{VMT_u * MPG_{ae} * MPG_{se}}{VMT_e * MPG_{au} * MPG_{su}} \right)$$

Where:

A = Adjustment factor applied to traded and transferred credits. The quotient shall be rounded to 4 decimal places;
 VMT_e = Lifetime vehicle miles traveled as provided in the following Table 1 to this paragraph (c) for the model year and compliance category in which the credit was earned;
 VMT_u = Lifetime vehicle miles traveled as provided in the following Table 1 to this

paragraph (c) for the model year and compliance category in which the credit is used for compliance;
 MPG_{se} = Required fuel economy standard for the originating (earning) manufacturer, compliance category, and model year in which the credit was earned;
 MPG_{ae} = Actual fuel economy for the originating manufacturer, compliance category, and model year in which the credit was earned;

MPG_{su} = Required fuel economy standard for the user (buying) manufacturer, compliance category, and model year in which the credit is used for compliance; and
 MPG_{au} = Actual fuel economy for the user manufacturer, compliance category, and model year in which the credit is used for compliance.

TABLE 1 TO § 536.4(c)—LIFETIME VEHICLE MILES TRAVELED [VMT]

Model year	Lifetime vehicle miles traveled (VMT)					
	2012	2013	2014	2015	2016	2017–2026
Passenger Cars	177,238	177,366	178,652	180,497	182,134	195,264
Light Trucks	208,471	208,537	209,974	212,040	213,954	225,865

§ 536.5 Trading infrastructure.

(a) *Accounts.* NHTSA maintains “accounts” for each credit holder. The account consists of a balance of credits in each compliance category and vintage held by the holder.

(b) *Who may hold credits.* Every manufacturer subject to fuel economy standards under part 531 or 533 of this chapter is automatically an account holder. If the manufacturer earns credits pursuant to this part, or receives credits from another party, so that the manufacturer’s account has a non-zero balance, then the manufacturer is also a credit holder. Any party designated as a recipient of credits by a current credit holder will receive an account from NHTSA and become a credit holder, subject to the following conditions:

(1) A designated recipient must provide name, address, contacting information, and a valid taxpayer

identification number or Social Security number;

(2) NHTSA does not grant a request to open a new account by any party other than a party designated as a recipient of credits by a credit holder; and

(3) NHTSA maintains accounts with zero balances for a period of time, but reserves the right to close accounts that have had zero balances for more than one year.

(c) *Automatic debits and credits of accounts.* (1) To carry credits forward, backward, transfer credits, or trade credits into other credit accounts, a manufacturer or credit holder must submit a credit instruction to NHTSA. A credit instruction must detail and include:

(i) The credit holder(s) involved in the transaction.

(ii) The originating credits described by the amount of the credits, compliance category and the vintage of the credits.

(iii) The recipient credit account(s) for banking or applying the originating credits described by the compliance category(ies), model year(s), and if applicable the adjusted credit amount(s) and adjustment factor(s).

(iv) For trades, a contract authorizing the trade signed by the manufacturers or credit holders or by managers legally authorized to obligate the sale and purchase of the traded credits.

(2) Upon receipt of a credit instruction from an existing credit holder, NHTSA verifies the presence of sufficient credits in the account(s) of the credit holder(s) involved as applicable and notifies the credit holder(s) that the credits will be debited from and/or credited to the accounts involved, as specified in the credit instruction. NHTSA determines if the credits can be debited or credited based upon the amount of available credits, accurate application of any adjustment factors

and the credit requirements prescribed by this part that are applicable at the time the transaction is requested.

(3) After notifying the credit holder(s), all accounts involved are either credited or debited, as appropriate, in line with the credit instruction. Traded credits identified by a specific compliance category are deposited into the recipient's account in that same compliance category and model year. If a recipient of credits as identified in a credit instruction is not a current account holder, NHTSA establishes the credit recipient's account, subject to the conditions described in paragraph (b) of this section, and adds the credits to the newly-opened account.

(4) NHTSA will automatically delete unused credits from holders' accounts when those credits reach their expiry date.

(5) Starting January 1, 2022, all parties trading credits must also provide NHTSA the price paid for the credits including a description of any other monetary or non-monetary terms affecting the price of the traded credits, such as any technology exchanged or shared in exchange for the credits, any other non-monetary payment for the credits, or any other agreements related to the trade.

(6) Starting September 1, 2022, manufacturers or credit holders issuing credit instructions or providing credit allocation plans as specified in paragraph (d) of this section, must use and submit the NHTSA Credit Template fillable form (Office of Management and Budget (OMB) Control No. 2127-0019, NHTSA Form 1475). In the case of a trade, manufacturers or credit holders buying traded credits must use the credit transactions template to submit trade instructions to NHTSA. Manufacturers or credit holders selling credits are not required to submit trade instructions. The NHTSA Credit Template must be signed by managers legally authorized to obligate the sale and/or purchase of the traded credits from both parties to the trade. The NHTSA Credit Template signed by both parties to the trade serves as an acknowledgement that the parties have agreed to trade a certain amount of credits, and does not dictate terms, conditions, or other business obligations of the parties.

(7) NHTSA will consider claims that information submitted to the agency under this section is entitled to confidential treatment under 5 U.S.C. 552(b) and under the provisions of part 512 of this chapter if the information is submitted in accordance with the procedures of part 512. The NHTSA Credit Template is available for

download on the CAFE Public Information Center website. Manufacturers must submit the cost information to NHTSA in a PDF document along with the Credit Template through the CAFE email, *cafe@dot.gov*. NHTSA reserves the right to request additional information from the parties regarding the terms of the trade.

(d) *Compliance*. (1) NHTSA assesses compliance with fuel economy standards each year, utilizing the certified and reported CAFE data provided by the Environmental Protection Agency (EPA) for enforcement of the CAFE program pursuant to 49 U.S.C. 32904(e). Credit values are calculated based on the CAFE data from the EPA. If a particular compliance category within a manufacturer's fleet has above standard fuel economy, NHTSA adds credits to the manufacturer's account for that compliance category and vintage in the appropriate amount by which the manufacturer has exceeded the applicable standard.

(2) If a manufacturer's vehicles in a particular compliance category have below standard fuel economy, NHTSA will provide written notification to the manufacturer that it has failed to meet a particular fleet target standard. The manufacturer will be required to confirm the shortfall and must either: submit a plan indicating how it will allocate existing credits or earn, transfer and/or acquire credits; or pay the appropriate civil penalty. The manufacturer must submit a plan or payment within 60 days of receiving agency notification.

(3) Credits used to offset shortfalls are subject to the three- and five-year limitations as described in § 536.6.

(4) Transferred credits are subject to the limitations specified by 49 U.S.C. 32903(g)(3) and this part.

(5) The value, when used for compliance, of any credits received via trade or transfer is adjusted, using the adjustment factor described in § 536.4(c), pursuant to 49 U.S.C. 32903(f)(1).

(6) Credit allocation plans received from a manufacturer will be reviewed and approved by NHTSA. Starting in model year 2022, credit holders must use the NHTSA Credit Template (OMB Control No. 2127-0019, NHTSA Forms 1475) to record the credit transactions. The template is a fillable form that has an option for recording and calculating credit transactions for credit allocation plans. The template calculates the required adjustments to the credits. The credit allocation plan and the completed transaction templates must be submitted

to NHTSA. NHTSA will approve the credit allocation plan unless it finds that the proposed credits are unavailable or that it is unlikely that the plan will result in the manufacturer earning sufficient credits to offset the subject credit shortfall. If the plan is approved, NHTSA will revise the respective manufacturer's credit account accordingly. If the plan is rejected, NHTSA will notify the respective manufacturer and request a revised plan or payment of the appropriate fine.

(e) *Reporting*. (1) NHTSA periodically publishes the names and credit holdings of all credit holders. NHTSA does not publish individual transactions, nor respond to individual requests for updated balances from any party other than the account holder.

(2) NHTSA issues an annual credit status letter to each party that is a credit holder at that time. The letter to a credit holder includes a credit accounting record that identifies the credit status of the credit holder including any activity (earned, expired, transferred, traded, carry-forward and carry-back credit transactions/allocations) that took place during the identified activity period.

§ 536.6 Treatment of credits earned prior to model year 2011.

(a) Credits earned in a compliance category before model year 2008 may be applied by the manufacturer that earned them to carryback plans for that compliance category approved up to three model years prior to the year in which the credits were earned, or may be applied to compliance in that compliance category for up to three model years after the year in which the credits were earned.

(b) Credits earned in a compliance category during and after model year 2008 may be applied by the manufacturer that earned them to carryback plans for that compliance category approved up to three years prior to the year in which the credits were earned, or may be held or applied for up to five model years after the year in which the credits were earned.

(c) Credits earned in a compliance category prior to model year 2011 may not be transferred or traded.

§ 536.7 Treatment of carryback credits.

(a) Carryback credits earned in a compliance category in any model year may be used in carryback plans approved by NHTSA, pursuant to 49 U.S.C. 32903(b), for up to three model years prior to the year in which the credit was earned.

(b) For purposes of this part, NHTSA will treat the use of future credits for compliance, as through a carryback

plan, as a deferral of penalties for non-compliance with an applicable fuel economy standard.

(c) If NHTSA receives and approves a manufacturer's carryback plan to earn future credits within the following three model years in order to comply with current regulatory obligations, NHTSA will defer levying fines for non-compliance until the date(s) when the manufacturer's approved plan indicates that credits will be earned or acquired to achieve compliance, and upon receiving confirmed CAFE data from EPA. If the manufacturer fails to acquire or earn sufficient credits by the plan dates, NHTSA will initiate compliance proceedings.

(d) In the event that NHTSA fails to receive or approve a plan for a non-compliant manufacturer, NHTSA will levy fines pursuant to statute. If within three years, the non-compliant manufacturer earns or acquires additional credits to reduce or eliminate the non-compliance, NHTSA will reduce any fines owed, or repay fines to the extent that credits received reduce the non-compliance.

(e) No credits from any source (earned, transferred and/or traded) will be accepted in lieu of compliance if those credits are not identified as originating within one of the three model years after the model year of the confirmed shortfall.

§ 536.8 Conditions for trading of credits.

(a) *Trading of credits.* If a credit holder wishes to trade credits to another party, the current credit holder and the receiving party must jointly issue an instruction to NHTSA, identifying the quantity, vintage, compliance category, and originator of the credits to be traded. If the recipient is not a current account holder, the recipient must provide sufficient information for NHTSA to establish an account for the recipient. Once an account has been established or identified for the recipient, NHTSA completes the trade by debiting the transferor's account and crediting the recipient's account. NHTSA will track the quantity, vintage, compliance category, and originator of all credits held or traded by all account-holders.

(b) *Trading between and within compliance categories.* For credits earned in model year 2011 or thereafter, and used to satisfy compliance obligations for model year 2011 or thereafter:

(1) Manufacturers may use credits originally earned by another manufacturer in a particular compliance category to satisfy compliance

obligations within the same compliance category.

(2) Once a manufacturer acquires by trade credits originally earned by another manufacturer in a particular compliance category, the manufacturer may transfer the credits to satisfy its compliance obligations in a different compliance category, but only to the extent that the CAFE increase attributable to the transferred credits does not exceed the limits in 49 U.S.C. 32903(g)(3). For any compliance category, the sum of a manufacturer's transferred credits earned by that manufacturer and transferred credits obtained by that manufacturer through trade must not exceed that limit.

(c) *Changes in corporate ownership and control.* Manufacturers must inform NHTSA of corporate relationship changes to ensure that credit accounts are identified correctly and credits are assigned and allocated properly.

(1) In general, if two manufacturers merge in any way, they must inform NHTSA how they plan to merge their credit accounts. NHTSA will subsequently assess corporate fuel economy and compliance status of the merged fleet instead of the original separate fleets.

(2) If a manufacturer divides or divests itself of a portion of its automobile manufacturing business, it must inform NHTSA how it plans to divide the manufacturer's credit holdings into two or more accounts. NHTSA will subsequently distribute holdings as directed by the manufacturer, subject to provision for reasonably anticipated compliance obligations.

(3) If a manufacturer is a successor to another manufacturer's business, it must inform NHTSA how it plans to allocate credits and resolve liabilities per part 534 of this chapter.

(d) *No short or forward sales.* NHTSA will not honor any instructions to trade or transfer more credits than are currently held in any account. NHTSA will not honor instructions to trade or transfer credits from any future vintage (*i.e.*, credits not yet earned). NHTSA will not participate in or facilitate contingent trades.

(e) *Cancellation of credits.* A credit holder may instruct NHTSA to cancel its currently held credits, specifying the originating manufacturer, vintage, and compliance category of the credits to be cancelled. These credits will be permanently null and void; NHTSA will remove the specific credits from the credit holder's account, and will not reissue them to any other party.

(f) *Errors or fraud in earning credits.* If NHTSA determines that a

manufacturer has been credited, through error or fraud, with earning credits, NHTSA will cancel those credits if possible. If the manufacturer credited with having earned those credits has already traded them when the error or fraud is discovered, NHTSA will hold the receiving manufacturer responsible for returning the same or equivalent credits to NHTSA for cancellation.

(g) *Error or fraud in trading.* In general, all trades are final and irrevocable once executed, and may only be reversed by a new, mutually-agreed transaction. If NHTSA executes an erroneous instruction to trade credits from one holder to another through error or fraud, NHTSA will reverse the transaction if possible. If those credits have been traded away, the recipient holder is responsible for obtaining the same or equivalent credits for return to the previous holder.

§ 536.9 Use of credits with regard to the domestically manufactured passenger automobile minimum standard.

(a) Each manufacturer is responsible for compliance with both the minimum standard and the attribute-based standard set out in the chapter.

(b) In any particular model year, the domestically manufactured passenger automobile compliance category credit excess or shortfall is determined by comparing the actual CAFE value against either the required standard value or the minimum standard value, whichever is larger.

(c) Transferred or traded credits may not be used, pursuant to 49 U.S.C. 32903(g)(4) and (f)(2), to meet the domestically manufactured passenger automobile minimum standard specified in 49 U.S.C. 32902(b)(4) and in 49 CFR 531.5(d).

(d) If a manufacturer's average fuel economy level for domestically manufactured passenger automobiles is lower than the attribute-based standard, but higher than the minimum standard, then the manufacturer may achieve compliance with the attribute-based standard by applying credits.

(e) If a manufacturer's average fuel economy level for domestically manufactured passenger automobiles is lower than the minimum standard, then the difference between the minimum standard and the manufacturer's actual fuel economy level may only be relieved by the use of credits earned by that manufacturer within the domestic passenger car compliance category which have not been transferred or traded. If the manufacturer does not have available earned credits to offset a credit shortage below the minimum standard then the manufacturer can

submit a carry-back plan that indicates sufficient future credits will be earned in its domestic passenger car compliance category or will be subject to penalties.

§ 536.10 Treatment of dual-fuel and alternative fuel vehicles—consistency with 49 CFR part 538.

(a) Statutory alternative fuel and dual-fuel vehicle fuel economy calculations are treated as a change in the underlying fuel economy of the vehicle for purposes of this part, not as a credit that may be transferred or traded. Improvements in alternative fuel or dual fuel vehicle fuel economy as calculated pursuant to 49 U.S.C. 32905 and limited by 49 U.S.C. 32906 are therefore attributable only to the particular compliance category and model year to which the alternative or dual-fuel vehicle belongs.

(b) If a manufacturer's calculated fuel economy for a particular compliance category, including any statutorily-required calculations for alternative fuel and dual fuel vehicles, is higher or lower than the applicable fuel economy standard, manufacturers will earn credits or must apply credits or pay civil penalties equal to the difference between the calculated fuel economy level in that compliance category and the applicable standard. Credits earned are the same as any other credits, and may be held, transferred, or traded by the manufacturer subject to the limitations of the statute and this part.

(c) For model years up to and including MY 2019, if a manufacturer builds enough dual fuel vehicles (except plug-in hybrid electric vehicles) to improve the calculated fuel economy in a particular compliance category by more than the limits set forth in 49 U.S.C. 32906(a), the improvement in fuel economy for compliance purposes is restricted to the statutory limit.

Manufacturers may not earn credits nor reduce the application of credits or fines for calculated improvements in fuel economy based on dual fuel vehicles beyond the statutory limit.

(d) For model years 2020 and beyond, a manufacturer must calculate the fuel economy of dual fueled vehicles in accordance with 40 CFR 600.510–12(c).

■ 4. Revise part 537 to read as follows:

PART 537—AUTOMOTIVE FUEL ECONOMY REPORTS

- Sec.
537.1 Scope.
537.2 Purpose.
537.3 Applicability.
537.4 Definitions.
537.5 General requirements for reports.
537.6 General content of reports.

- 537.7 Pre-model year and mid-model year reports.
537.8 Supplementary reports.
537.9 Determination of fuel economy values and average fuel economy.
537.10 Incorporation by reference by manufacturers.
537.11 Public inspection of information.
537.12 Confidential information.

Authority: 49 U.S.C. 32907; delegation of authority at 49 CFR 1.95.

§ 537.1 Scope.

This part establishes requirements for automobile manufacturers to submit reports to the National Highway Traffic Safety Administration regarding their efforts to improve automotive fuel economy.

§ 537.2 Purpose.

The purpose of this part is to obtain information to aid the National Highway Traffic Safety Administration in valuating automobile manufacturers' plans for complying with average fuel economy standards and in preparing an annual review of the average fuel economy standards.

§ 537.3 Applicability.

This part applies to automobile manufacturers, except for manufacturers subject to an alternate fuel economy standard under section 502(c) of the Act.

§ 537.4 Definitions.

(a) *Statutory terms.* (1) The terms *average fuel economy standard*, *fuel*, *manufacture*, and *model year* are used as defined in section 501 of the Act.

(2) The term *manufacturer* is used as defined in section 501 of the Act and in accordance with part 529 of this chapter.

(3) The terms *average fuel economy*, *fuel economy*, and *model type* are used as defined in subpart A of 40 CFR part 600.

(4) The terms *automobile*, *automobile capable of off-highway operation*, and *passenger automobile* are used as defined in section 501 of the Act and in accordance with the determinations in part 523 of this chapter.

(b) *Other terms.* (1) The term *loaded vehicle weight* is used as defined in subpart A of 40 CFR part 86.

(2) The terms *axle ratio*, *base level*, *body style*, *car line*, *combined fuel economy*, *engine code*, *equivalent test weight*, *gross vehicle weight*, *inertia weight*, *transmission class*, and *vehicle configuration* are used as defined in subpart A of 40 CFR part 600.

(3) The term *light truck* is used as defined in part 523 of this chapter and in accordance with determinations in part 523.

(4) The terms *approach angle*, *axle clearance*, *brakeover angle*, *cargo carrying volume*, *departure angle*, *passenger carrying volume*, *running clearance*, and *temporary living quarters* are used as defined in part 523 of this chapter.

(5) The term *incomplete automobile manufacturer* is used as defined in part 529 of this chapter.

(6) As used in this part, unless otherwise required by the context:

(i) *Act* means the Motor Vehicle Information and Cost Savings Act (Pub. L. 92–513), as amended by the Energy Policy and Conservation Act (Pub. L. 94–163).

(ii) *Administrator* means the Administrator of the National Highway Traffic Safety Administration (NHTSA) or the Administrator's delegate.

(iii) *Current model year* means:

(A) In the case of a pre-model year report, the full model year immediately following the period during which that report is required by § 537.5(b) to be submitted.

(B) In the case of a mid-model year report, the model year during which that report is required by § 537.5(b) to be submitted.

(iv) *Average* means a production-weighted harmonic average.

(v) *Total drive ratio* means the ratio of an automobile's engine rotational speed (in revolutions per minute) to the automobile's forward speed (in miles per hour).

§ 537.5 General requirements for reports.

(a) For each current model year, each manufacturer shall submit a pre-model year report, a mid-model year report, and, as required by § 537.8, supplementary reports.

(b)(1) The pre-model year report required by this part for each current model year must be submitted during the month of December (e.g., the pre-model year report for the 1983 model year must be submitted during December 1982).

(2) The mid-model year report required by this part for each current model year must be submitted during the month of July (e.g., the mid-model year report for the 1983 model year must be submitted during July 1983).

(3) Each supplementary report must be submitted in accordance with § 537.8(c).

(c) Each report required by this part must:

(1) Identify the report as a pre-model year report, mid-model year report, or supplementary report as appropriate;

(2) Identify the manufacturer submitting the report;

(3) State the full name, title, and address of the official responsible for preparing the report;

(4) Be submitted electronically to *cafe@dot.gov*. For each report, manufacturers should submit a confidential version and a non-confidential (*i.e.*, redacted) version. The confidential report should be accompanied by a request letter that contains supporting information, pursuant to § 512.8 of this chapter. Your request must also include a certificate, pursuant to § 512.4(b) of this chapter and part 512, appendix A, of this chapter. The word “CONFIDENTIAL” must appear on the top of each page containing information claimed to be confidential. If an entire page is claimed to be confidential, the submitter must indicate clearly that the entire page is claimed to be confidential. If the information for which confidentiality is being requested is contained within a page, the submitter shall enclose each item of information that is claimed to be confidential within brackets: “[.]” Confidential portions of electronic files submitted in other than their original format must be marked “Confidential Business Information” or “Entire Page Confidential Business Information” at the top of each page. If only a portion of a page is claimed to be confidential, that portion shall be designated by brackets. Files submitted in their original format that cannot be marked as described above must, to the extent practicable, identify confidential information by alternative markings using existing attributes within the file or means that are accessible through use of the file’s associated program. A representative from NHTSA’s Office of Chief Counsel, as designated by NHTSA, should be copied on any submissions with confidential business information;

(5) Identify the current model year;

(6) Be written in the English language; and

(7)(i) Specify any part of the information or data in the report that the manufacturer believes should be withheld from public disclosure as trade secret or other confidential business information.

(ii) With respect to each item of information or data requested by the manufacturer to be withheld under 5 U.S.C. 552(b)(4) and 15 U.S.C. 2005(d)(1), the manufacturer shall:

(A) Show that the item is within the scope of sections 552(b)(4) and 2005(d)(1);

(B) Show that disclosure of the item would result in significant competitive damage;

(C) Specify the period during which the item must be withheld to avoid that damage; and

(D) Show that earlier disclosure would result in that damage.

(d) Beginning with model year 2023, each manufacturer shall generate reports required by this part using the NHTSA CAFE Projections Reporting Template (Office of Management and Budget (OMB) Control No. 2127–0019, NHTSA Form 1474). The template is a fillable form.

(1) Manufacturers must select the option to identify the report as a pre-model year report, mid-model year report, or supplementary report as appropriate.

(2) Manufacturers must complete all required information for the manufacturer and for all vehicles produced for the current model year required to comply with corporate average fuel economy (CAFE) standards. The manufacturer must identify the manufacturer submitting the report, including the full name, title, and address of the official responsible for preparing the report and a point of contact to answer questions concerning the report.

(3) Manufacturers must use the template to generate confidential and non-confidential reports for all the domestic and import passenger cars and light truck fleet produced by the manufacturer for the current model year. Manufacturers must submit a request for confidentiality in accordance with part 512 of this chapter to withhold projected production sales volume estimates from public disclosure. If the request is granted, NHTSA will withhold the projected production sales volume estimates from public disclosure until all the vehicles produced by the manufacturer have been made available for sale (usually one year after the current model year).

(4) Manufacturers must submit confidential reports and requests for confidentiality to NHTSA on CD-ROM in accordance with § 537.12. Email copies of non-confidential (*i.e.*, redacted) reports to NHTSA’s secure email address: *cafe@dot.gov*. Requests for confidentiality must be submitted in a PDF or MS Word format. Submit 2 copies of the CD-ROM to: Administrator, National Highway Traffic Administration, 1200 New Jersey Avenue SE, Washington, DC 20590, and submit emailed reports electronically to the following secure email address: *cafe@dot.gov*.

(5) Manufacturers can withhold information on projected production sales volumes under 5 U.S.C. 552(b)(4)

and 15 U.S.C. 2005(d)(1). In accordance, the manufacturer must:

(i) Show that the item is within the scope of sections 552(b)(4) and 2005(d)(1);

(ii) Show that disclosure of the item would result in significant competitive damage;

(iii) Specify the period during which the item must be withheld to avoid that damage; and

(iv) Show that earlier disclosure would result in that damage.

(e) Each report required by this part must be based upon all information and data available to the manufacturer 30 days before the report is submitted to the Administrator.

§ 537.6 General content of reports.

(a) Pre-model year and mid-model year reports. Except as provided in paragraph (c) of this section, each pre-model year report and the mid-model year report for each model year must contain the information required by § 537.7(a).

(b) Supplementary report. Except as provided in paragraph (c) of this section, each supplementary report for each model year must contain the information required by § 537.7(a)(1) and (2), as appropriate for the vehicle fleets produced by the manufacturer, in accordance with § 537.8(b)(1) through (4) as appropriate.

(c) Exceptions. The pre-model year report, mid-model year report, and supplementary report(s) submitted by an incomplete automobile manufacturer for any model year are not required to contain the information specified in § 537.7(c)(4)(xv) through (xviii) and (c)(5). The information provided by the incomplete automobile manufacturer under § 537.7(c) shall be according to base level instead of model type or carline.

§ 537.7 Pre-model year and mid-model year reports.

(a) *Report submission requirements.*

(1) Manufacturers must provide a report with the information required by paragraphs (b) and (c) of this section for each domestic and import passenger automobile fleet, as specified in part 531 of this chapter, for the current model year.

(2) Manufacturers must provide a report with the information required by paragraphs (b) and (c) of this section for each light truck fleet, as specified in part 533 of this chapter, for the current model year.

(3) For model year 2023 and later, for passenger cars specified in part 531 and light trucks specified in part 533 of this chapter, manufacturers must provide

the information for pre-model and mid-model year reports in accordance with the NHTSA CAFE Projections Reporting Template (OMB Control No. 2127–0019, NHTSA Form 1474). The required reporting template can be downloaded from NHTSA's website.

(i) Manufacturers are only required to provide the actual information on vehicles and technologies in production at the time the pre- and mid-model year reports are required. Otherwise, manufacturers must provide reasonable estimates or updated estimates where possible for pre- and mid-model year reports.

(ii) Manufacturers should attempt not to omit data which should only be the done for products pending production and with unknown information at the time CAFE reports are prepared.

(b) *Projected average and required fuel economy.* (1) Manufacturers must state the projected average fuel economy for the manufacturer's automobiles determined in accordance with § 537.9 and based upon the fuel economy values and projected sales figures provided under paragraph (c)(2) of this section.

(2) Manufacturers must state the projected final average fuel economy that the manufacturer anticipates having if changes implemented during the model year will cause that average to be different from the average fuel economy projected under paragraph (b)(1) of this section.

(3) Manufacturers must state the projected required fuel economy for the manufacturer's passenger automobiles and light trucks determined in accordance with §§ 531.5(c) and 533.5 of this chapter and based upon the projected sales figures provided under paragraph (c)(2) of this section. For each unique model type and footprint combination of the manufacturer's automobiles, the manufacturer must provide the information specified in paragraphs (b)(3)(i) and (ii) of this section in tabular form. The manufacturer must list the model types in order of increasing average inertia weight from top to bottom down the left side of the table and list the information categories in the order specified in paragraphs (b)(3)(i) and (ii) of this section from left to right across the top of the table. Other formats, such as those accepted by the Environmental Protection Agency (EPA), which contain all the information in a readily identifiable format are also acceptable. For model year 2023 and later, for each unique model type and footprint combination of the manufacturer's automobiles, the manufacturer must provide the information specified in

paragraphs (b)(3)(i) and (ii) of this section in accordance with the CAFE Projections Reporting Template (OMB Control No. 2127–0019, NHTSA Form 1474).

(i) In the case of passenger automobiles, manufacturers must report the following:

(A) Beginning model year 2013, base tire as defined in § 523.2 of this chapter;

(B) Beginning model year 2013, front axle, rear axle, and average track width as defined in § 523.2 of this chapter;

(C) Beginning model year 2013, wheelbase as defined in § 523.2 of this chapter;

(D) Beginning model year 2013, footprint as defined in § 523.2 of this chapter; and

(E) The fuel economy target value for each unique model type and footprint entry listed in accordance with the equation provided in part 531 of this chapter.

(ii) In the case of light trucks, manufacturers must report the following:

(A) Beginning model year 2013, base tire as defined in § 523.2 of this chapter;

(B) Beginning model year 2013, front axle, rear axle, and average track width as defined in § 523.2 of this chapter;

(C) Beginning model year 2013, wheelbase as defined in § 523.2 of this chapter;

(D) Beginning model year 2013, footprint as defined in § 523.2 of this chapter; and

(E) The fuel economy target value for each unique model type and footprint entry listed in accordance with the equation provided in part 533 of this chapter.

(4) Manufacturers must state the projected final required fuel economy that the manufacturer anticipates having if changes implemented during the model year will cause the targets to be different from the target fuel economy projected under paragraph (b)(3) of this section.

(5) Manufacturers must state whether the manufacturer believes that the projections it provides under paragraphs (b)(2) and (4) of this section, or if it does not provide an average or target under paragraphs (b)(2) and (4), the projections it provides under paragraphs (b)(1) and (3) of this section, sufficiently represent the manufacturer's average and target fuel economy for the current model year for purposes of the Act. In the case of a manufacturer that believes that the projections are not sufficiently representative for the purpose of determining the projected average fuel economy for the manufacturer's automobiles, the manufacturers must state the specific nature of any reason

for the insufficiency and the specific additional testing or derivation of fuel economy values by analytical methods believed by the manufacturer necessary to eliminate the insufficiency and any plans of the manufacturer to undertake that testing or derivation voluntarily and submit the resulting data to the EPA under 40 CFR 600.509–12.

(c) *Model type and configuration fuel economy and technical information.* (1) For each model type of the manufacturer's automobiles, the manufacturers must provide the information specified in paragraph (c)(2) of this section in tabular form. List the model types in order of increasing average inertia weight from top to bottom down the left side of the table and list the information categories in the order specified in paragraph (c)(2) of this section from left to right across the top of the table. For model year 2023 and later, CAFE reports required by this part, shall for each model type of the manufacturer's automobiles, provide the information in specified in paragraph (c)(2) of this section in accordance with the NHTSA CAFE Projections Reporting Template (OMB Control No. 2127–0019, NHTSA Form 1474) and list the model types in order of increasing average inertia weight from top to bottom.

(2)(i) Combined fuel economy; and

(ii) Projected sales for the current model year and total sales of all model types.

(3) For pre-model year reports only through model year 2022, for each vehicle configuration whose fuel economy was used to calculate the fuel economy values for a model type under paragraph (c)(2) of this section, manufacturers must provide the information specified in paragraph (c)(4) of this section in accordance with the NHTSA CAFE Projections Reporting Template (OMB Control No. 2127–0019, NHTSA Form 1474).

(4)(i) Loaded vehicle weight;
(ii) Equivalent test weight;
(iii) Engine displacement, liters;
(iv) Society of Automotive Engineers (SAE) net rated power, kilowatts;
(v) SAE net horsepower;
(vi) Engine code;
(vii) Fuel system (number of carburetor barrels or, if fuel injection is used, so indicate);
(viii) Emission control system;
(ix) Transmission class;
(x) Number of forward speeds;
(xi) Existence of overdrive (indicate yes or no);
(xii) Total drive ratio (N/V);
(xiii) Axle ratio;
(xiv) Combined fuel economy;
(xv) Projected sales for the current model year;

(xvi)(A) In the case of passenger automobiles:

(1) Interior volume index, determined in accordance with subpart D of 40 CFR part 600; and

(2) Body style;

(B) In the case of light trucks:

(1) Passenger-carrying volume; and

(2) Cargo-carrying volume;

(xvii) Frontal area;

(xviii) Road load power at 50 miles per hour, if determined by the manufacturer for purposes other than compliance with this part to differ from the road load setting prescribed in 40 CFR 86.177–11(d); and

(xix) Optional equipment that the manufacturer is required under 40 CFR parts 86 and 600 to have actually installed on the vehicle configuration, or the weight of which must be included in the curb weight computation for the vehicle configuration, for fuel economy testing purposes.

(5) For each model type of automobile which is classified as a non-passenger vehicle (light truck) under part 523 of this chapter, manufacturers must provide the following data:

(i) For an automobile designed to perform at least one of the following functions in accordance with § 523.5(a) of this chapter, indicate (by “yes” or “no” for each function) whether the vehicle can:

(A) Transport more than 10 persons (if yes, provide actual designated seating positions);

(B) Provide temporary living quarters (if yes, provide applicable conveniences as defined in § 523.2 of this chapter);

(C) Transport property on an open bed (if yes, provide bed size width and length);

(D) Provide, as sold to the first retail purchaser, greater cargo-carrying than passenger-carrying volume, such as in a cargo van and quantify the value which should be the difference between the values provided in paragraphs

(c)(4)(xvi)(B)(1) and (2) of this section; if a vehicle is sold with a second-row seat, its cargo-carrying volume is determined with that seat installed, regardless of whether the manufacturer has described that seat as optional; or

(E) Permit expanded use of the automobile for cargo-carrying purposes or other non-passenger-carrying purposes through:

(1) For non-passenger automobiles manufactured prior to model year 2012, the removal of seats by means of uninstalling by the automobile’s manufacturer or by uninstalling with simple tools, such as screwdrivers and wrenches, so as to create a flat, floor level, surface extending from the forward-most point of installation of

those seats to the rear of the automobile’s interior; or

(2) For non-passenger automobiles manufactured in model year 2008 and beyond, for vehicles equipped with at least 3 rows of designated seating positions as standard equipment, permit expanded use of the automobile for cargo-carrying purposes or other nonpassenger-carrying purposes through the removal or stowing of foldable or pivoting seats so as to create a flat, leveled cargo surface extending from the forward-most point of installation of those seats to the rear of the automobile’s interior.

(ii) For an automobile capable of off-highway operation, identify which of the features in paragraphs (c)(5)(ii)(A) through (C) of this section qualify the vehicle as off-road in accordance with § 523.5(b) of this chapter and quantify the values of each feature:

(A) 4-wheel drive; or

(B) A rating of more than 6,000 pounds gross vehicle weight; and

(C) Has at least four of the following characteristics calculated when the automobile is at curb weight, on a level surface, with the front wheels parallel to the automobile’s longitudinal centerline, and the tires inflated to the manufacturer’s recommended pressure. The exact value of each feature should be quantified:

(1) Approach angle of not less than 28 degrees.

(2) Breakover angle of not less than 14 degrees.

(3) Departure angle of not less than 20 degrees.

(4) Running clearance of not less than 20 centimeters.

(5) Front and rear axle clearances of not less than 18 centimeters each.

(6) Manufacturers must determine the fuel economy values provided under paragraphs (c)(2) and (4) of this section in accordance with § 537.9.

(7) Manufacturers must identify any air-conditioning (AC), off-cycle and full-size pick-up truck technologies used each model year to calculate the average fuel economy specified in 40 CFR 600.510–12.

(i) Provide a list of each air conditioning efficiency improvement technology utilized in your fleet(s) of vehicles for each model year. For each technology identify vehicles by make and model types that have the technology, which compliance category those vehicles belong to and the number of vehicles for each model equipped with the technology. For each compliance category (domestic passenger car, import passenger car, and light truck), report the air conditioning fuel consumption improvement value in

gallons/mile in accordance with the equation specified in 40 CFR 600.510–12(c)(3)(i).

(ii) Manufacturers must provide a list of off-cycle efficiency improvement technologies utilized in its fleet(s) of vehicles for each model year that is pending or approved by the EPA. For each technology, manufacturers must identify vehicles by make and model types that have the technology, which compliance category those vehicles belong to, the number of vehicles for each model equipped with the technology, and the associated off-cycle credits (grams/mile) available for each technology. For each compliance category (domestic passenger car, import passenger car, and light truck), manufacturers must calculate the fleet off-cycle fuel consumption improvement value in gallons/mile in accordance with the equation specified in 40 CFR 600.510–12(c)(3)(ii).

(iii) Manufacturers must provide a list of full-size pickup trucks in its fleet that meet the mild and strong hybrid vehicle definitions in 40 CFR 86.1803–01. For each mild and strong hybrid type, manufacturers must identify vehicles by make and model types that have the technology, the number of vehicles produced for each model equipped with the technology, the total number of full-size pickup trucks produced with and without the technology, the calculated percentage of hybrid vehicles relative to the total number of vehicles produced, and the associated full-size pickup truck credits (grams/mile) available for each technology. For the light truck compliance category, manufacturers must calculate the fleet pickup truck fuel consumption improvement value in gallons/mile in accordance with the equation specified in 40 CFR 600.510–12(c)(3)(iii).

§ 537.8 Supplementary reports.

(a)(1) Except as provided in paragraph (d) of this section, each manufacturer whose most recently submitted mid-model year report contained an average fuel economy projection under § 537.7(b)(2) or, if no average fuel economy was projected under that section, under § 537.7(b)(1), that was not less than the applicable average fuel economy standard in this chapter and who now projects an average fuel economy which is less than the applicable standard in this chapter shall file a supplementary report containing the information specified in paragraph (b)(1) of this section.

(2) Except as provided in paragraph (d) of this section, each manufacturer that determines that its average fuel economy for the current model year as

projected under § 537.7(b)(2) or, if no average fuel economy was projected under § 537.7(b)(2), as projected under § 537.7(b)(1), is less representative than the manufacturer previously reported it to be under § 537.7(b)(3), this section, or both, shall file a supplementary report containing the information specified in paragraph (b)(2) of this section.

(3) For model years through 2022, each manufacturer whose mid-model year report omits any of the information specified in § 537.7(b) or (c) shall file a supplementary report containing the information specified in paragraph (b)(3) of this section.

(4) Starting model year 2023, each manufacturer whose mid-model year report omits any of the information shall resubmit the information with other information required in accordance with the NHTSA CAFE Projections Reporting Template (OMB Control No. 2127–0019, NHTSA Form 1474).

(b)(1) The supplementary report required by paragraph (a)(1) of this section must contain:

(i) Such revisions of and additions to the information previously submitted by the manufacturer under this part regarding the automobiles whose projected average fuel economy has decreased as specified in paragraph (a)(1) of this section as are necessary—

(A) To reflect the change and its cause; and

(B) To indicate a new projected average fuel economy based upon these additional measures.

(ii) An explanation of the cause of the decrease in average fuel economy that led to the manufacturer's having to submit the supplementary report required by paragraph (a)(1) of this section.

(2) The supplementary report required by paragraph (a)(2) of this section must contain:

(i) A statement of the specific nature of and reason for the insufficiency in the representativeness of the projected average fuel economy;

(ii) A statement of specific additional testing or derivation of fuel economy values by analytical methods believed by the manufacturer necessary to eliminate the insufficiency; and

(iii) A description of any plans of the manufacturer to undertake that testing or derivation voluntarily and submit the resulting data to the Environmental Protection Agency under 40 CFR 600.509–12.

(3) The supplementary report required by paragraph (a)(3) of this section must contain:

(i) All of the information omitted from the mid-model year report under § 537.6(c)(2); and

(ii) Such revisions of and additions to the information submitted by the manufacturer in its mid-model year report regarding the automobiles produced during the current model year as are necessary to reflect the information provided under paragraph (b)(3)(i) of this section.

(4) The supplementary report required by paragraph (a)(4) of this section must contain:

(i) All information omitted from the mid-model year reports under § 537.6(c)(2); and

(ii) Such revisions of and additions to the information submitted by the manufacturer in its pre-model or mid-model year reports regarding the automobiles produced during the current model year as are necessary to reflect the information provided under paragraph (b)(4)(i) of this section.

(c)(1) Each report required by paragraph (a)(1), (2), (3), or (4) of this section must be submitted in accordance with § 537.5(c) not more than 45 days after the date on which the manufacturer determined, or could have determined with reasonable diligence, that the report was required.

(2) [Reserved]

(d) A supplementary report is not required to be submitted by the manufacturer under paragraph (a)(1) or (2) of this section:

(1) With respect to information submitted under this part before the most recent mid-model year report submitted by the manufacturer under this part; or

(2) When the date specified in paragraph (c) of this section occurs after the day by which the pre-model year report for the model year immediately following the current model year must be submitted by the manufacturer under this part.

(e) For model years 2008, 2009, and 2010, each manufacturer of light trucks, as that term is defined in § 523.5 of this chapter, shall submit a report, not later than 45 days following the end of the model year, indicating whether the manufacturer is opting to comply with § 533.5(f) or (g) of this chapter.

§ 537.9 Determination of fuel economy values and average fuel economy.

(a) *Vehicle subconfiguration fuel economy values.* (1) For each vehicle subconfiguration for which a fuel economy value is required under paragraph (c) of this section and has been determined and approved under 40 CFR part 600, the manufacturer shall submit that fuel economy value.

(2) For each vehicle subconfiguration specified in paragraph (a)(1) of this section for which a fuel economy value

approved under 40 CFR part 600, does not exist, but for which a fuel economy value determined under 40 CFR part 600 exists, the manufacturer shall submit that fuel economy value.

(3) For each vehicle subconfiguration specified in paragraph (a)(1) of this section for which a fuel economy value has been neither determined nor approved under 40 CFR part 600, the manufacturer shall submit a fuel economy value based on tests or analyses comparable to those prescribed or permitted under 40 CFR part 600 and a description of the test procedures or analytical methods used.

(4) For each vehicle configuration for which a fuel economy value is required under paragraph (c) of this section and has been determined and approved under 40 CFR part 600, the manufacturer shall submit that fuel economy value.

(b) *Base level and model type fuel economy values.* For each base level and model type, the manufacturer shall submit a fuel economy value based on the values submitted under paragraph (a) of this section and calculated in the same manner as base level and model type fuel economy values are calculated for use under subpart F of 40 CFR part 600.

(c) *Average fuel economy.* Average fuel economy must be based upon fuel economy values calculated under paragraph (b) of this section for each model type and must be calculated in accordance with subpart F of 40 CFR part 600, except that fuel economy values for running changes and for new base levels are required only for those changes made or base levels added before the average fuel economy is required to be submitted under this part.

§ 537.10 Incorporation by reference by manufacturers.

(a) A manufacturer may incorporate by reference in a report required by this part any document other than a report, petition, or application, or portion thereof submitted to any Federal department or agency more than two model years before the current model year.

(b) A manufacturer that incorporates by references a document not previously submitted to the National Highway Traffic Safety Administration shall append that document to the report.

(c) A manufacturer that incorporates by reference a document shall clearly identify the document and, in the case of a document previously submitted to the National Highway Traffic Safety Administration, indicate the date on which and the person by whom the document was submitted to this agency.

§ 537.11 Public inspection of information.

Except as provided in § 537.12, any person may inspect the information and data submitted by a manufacturer under this part in the docket section of the National Highway Traffic Safety Administration. Any person may obtain copies of the information available for inspection under this section in accordance with the regulations of the Secretary of Transportation in part 7 of this title.

§ 537.12 Confidential information.

(a) *Treatment of confidential information.* Information made available under § 537.11 for public inspection does not include information for which confidentiality is requested under

§ 537.5(c)(7), is granted in accordance with section 505 of the Act and 5 U.S.C. 552(b) and is not subsequently released under paragraph (c) of this section in accordance with section 505 of the Act.

(b) *Denial of confidential treatment.* When the Administrator denies a manufacturer's request under § 537.5(c)(7) for confidential treatment of information, the Administrator gives the manufacturer written notice of the denial and reasons for it. Public disclosure of the information is not made until after the ten-day period immediately following the giving of the notice.

(c) *Release of confidential information.* After giving written notice

to a manufacturer and allowing ten days, when feasible, for the manufacturer to respond, the Administrator may make available for public inspection any information submitted under this part that is relevant to a proceeding under the Act, including information that was granted confidential treatment by the Administrator pursuant to a request by the manufacturer under § 537.5(c)(7).

Issued on March 31, 2022, in Washington, DC, under authority delegated in 49 CFR 1.95.

Steven S. Cliff,

Deputy Administrator.

[FR Doc. 2022-07200 Filed 4-19-22; 11:15 am]

BILLING CODE 4910-59-P